

03.12-06/29/95-01499

FINAL

**REMEDIAL INVESTIGATION REPORT
OPERABLE UNIT NO. 7
(SITES 1, 28, AND 30)**

**MARINE CORPS BASE
CAMP LEJEUNE, NORTH CAROLINA**

CONTRACT TASK ORDER 0231

JUNE 29, 1995

Prepared For:

**DEPARTMENT OF THE NAVY
ATLANTIC DIVISION
NAVAL FACILITIES
ENGINEERING COMMAND
*Norfolk, Virginia***

Under:

**LANTDIV CLEAN Program
Contract N62470-89-D-4814**

Prepared by:

**BAKER ENVIRONMENTAL, INC.
*Coraopolis, Pennsylvania***

TABLE OF CONTENTS

Page

VOLUME I - SITE 1 (SEPARATE DOCUMENT)

LIST OF ACRONYMS	xxiv
EXECUTIVE SUMMARY	ES-1
1.0 INTRODUCTION	1-1
1.1 Report Organization	1-1
1.2 Operable Unit Description	1-2
1.3 Background and Setting of MCB, Camp Lejeune	1-2
1.3.1 Location and Setting	1-2
1.3.2 History	1-2
1.3.3 Topography	1-3
1.3.4 Meteorology	1-3
1.3.5 Geology	1-3
1.3.6 Hydrogeology	1-4
1.3.7 Land Use and Demography	1-5
1.3.8 Ecology	1-6
2.0 SITE BACKGROUND AND SETTING	2-1
2.1 Site Description	2-1
2.2 Site History	2-2
2.3 Previous Investigations	2-3
2.3.1 Initial Assessment Study	2-3
2.3.2 Confirmation Study	2-3
2.3.3 Additional Investigations	2-6
2.3.4 Aerial Photographic Investigation	2-7
2.4 Remedial Investigation Objectives	2-8
3.0 STUDY AREA INVESTIGATIONS	3-1
3.1 Site Survey	3-1
3.2 Soil Investigation	3-1
3.2.1 Drilling Procedures	3-1
3.2.2 Soil Sampling Locations	3-2
3.2.3 Soil Sampling Procedures	3-3
3.2.4 Analytical Program	3-3
3.2.5 Quality Assurance and Quality Control	3-4
3.2.6 Air Monitoring and Field Screening	3-5
3.3 Groundwater Investigation	3-5
3.3.1 Monitoring Well Installation	3-5
3.3.2 Monitoring Well Development	3-6
3.3.3 Water Level Measurements	3-7
3.3.4 Groundwater Sampling Locations	3-7

TABLE OF CONTENTS
(Continued)

	<u>Page</u>	
3.3.5	Groundwater Sampling Procedures	3-7
3.3.6	Analytical Program	3-8
3.3.7	Quality Assurance and Quality Control	3-9
3.3.8	Field Screening and Air Monitoring	3-9
3.3.9	Well Abandonment	3-9
3.4	Decontamination Procedures	3-9
3.5	Investigation Derived Waste (IDW) Handling	3-10
4.0	SITE PHYSICAL CHARACTERISTICS	4-1
4.1	Topography	4-1
4.2	Surface Water Hydrology and Drainage Features	4-1
4.3	Subsurface Soil Conditions	4-1
4.3.1	Geology	4-1
4.3.2	Surface Soils	4-2
4.4	Hydrogeology	4-3
4.5	Ecology	4-4
4.6	Identification of Water Supply Wells	4-4
5.0	NATURE AND EXTENT OF CONTAMINATION	5-1
5.1	Data Quality	5-1
5.1.1	Data Management and Tracking	5-1
5.2	Non-Site Related Analytical Results	5-2
5.2.1	Laboratory Contaminants	5-2
5.2.2	Naturally-Occurring Inorganic Contaminants	5-3
5.3	Analytical Results	5-4
5.3.1	Soil Investigation	5-5
5.3.2	Groundwater Investigation	5-7
5.4	Extent of Contamination	5-9
5.4.1	Extent of Soil Contamination	5-10
5.4.2	Extent of Groundwater Contamination	5-11
6.0	CONTAMINANT FATE AND TRANSPORT	6-1
6.1	Chemical and Physical Properties Impacting Fate and Transport	6-1
6.2	Contaminant Transport Pathways	6-2
6.2.1	On-Site Deposition of Windblown Dust	6-3
6.2.2	Leaching of Sediment Contaminants to Surface Water	6-3
6.2.3	Leaching of Soil Contaminants to Groundwater	6-3
6.2.4	Migration of Groundwater Contaminants	6-3
6.3	Fate and Transport Summary	6-6
6.3.1	Volatile Organic Compounds	6-6
6.3.2	Polynuclear Aromatic Hydrocarbons	6-7

TABLE OF CONTENTS
(Continued)

	<u>Page</u>
6.3.3 Pesticides/Polychlorinated Biphenyls	6-7
6.3.4 Inorganics	6-7
7.0 BASELINE HUMAN HEALTH RISK ASSESSMENT	7-1
7.1 Introduction	7-1
7.2 Hazard Identification	7-2
7.2.1 Data Evaluation and Reduction	7-2
7.2.2 Identify Data Suitable for Use in a Quantitative Risk Assessment ..	7-3
7.2.3 Criteria Used in Selection of COPCs	7-3
7.2.4 Contaminants of Potential Concern (COPCs)	7-7
7.3 Exposure Assessment	7-9
7.3.1 Potential Human Receptors and Adjacent Populations	7-9
7.3.2 Exposure Pathways	7-11
7.3.3 Quantification of Exposure	7-14
7.3.4 Calculation of Chronic Daily Intakes	7-15
7.4 Toxicity Assessment	7-22
7.4.1 Carcinogenic Slope Factor	7-22
7.4.2 Reference Dose	7-23
7.4.3 Lead	7-24
7.4.4 Dermal Adjustment of Toxicity Factors	7-25
7.5 Risk Characterization	7-25
7.5.1 Human Health Risks	7-26
7.6 Standards/Criteria/TBC Comparison Results	7-27
7.6.1 Surface Soil	7-27
7.6.2 Subsurface Soil	7-27
7.6.3 Groundwater	7-28
7.7 Sources of Uncertainty	7-28
7.7.1 Analytical Data Uncertainty	7-29
7.7.2 Exposure Assessment Uncertainty	7-29
7.7.3 Sampling Strategy Uncertainty	7-30
7.7.4 Toxicity Assessment Uncertainty	7-30
7.8 Conclusions of the BRA for Site 1	7-31
8.0 ECOLOGICAL RISK ASSESSMENT	8-1
8.1 Introduction	8-1
8.1.1 Objectives of the Ecological Risk Assessment	8-1
8.1.2 Scope of the Ecological Risk Assessment	8-1
8.1.3 Organization of The Ecological Risk Assessment	8-2
8.2 Problem Formulation	8-2
8.2.1 Stressor Characteristics	8-3
8.2.2 Ecosystems Potentially at Risk	8-5

TABLE OF CONTENTS
(Continued)

	<u>Page</u>
8.2.3 Ecological Effects	8-5
8.2.4 Ecological Endpoints	8-5
8.2.5 The Conceptual Model	8-7
8.3 Analysis Phase	8-7
8.3.1 Characterization of Exposure	8-7
8.3.2 Ecological Effects Characterization	8-9
8.4 Risk Characterization	8-12
8.4.1 Surface Soils	8-12
8.4.2 Terrestrial Chronic Daily Intake Model	8-12
8.4.3 Other Sensitive Environments	8-13
8.5 Ecological Significance	8-14
8.5.1 Terrestrial Endpoints	8-14
8.5.2 Threatened and Endangered Species	8-14
8.6 Uncertainty Analysis	8-14
8.7 Conclusions	8-15
9.0 CONCLUSIONS	9-1
VOLUME II - SITE 28 (SEPARATE DOCUMENT)	
10.0 INTRODUCTION	10-1
11.0 SITE BACKGROUND AND SETTING	11-1
11.1 Site Description	11-1
11.2 Site History	11-1
11.3 Previous Investigations	11-2
11.3.1 Initial Assessment Study	11-2
11.3.2 Confirmation Study	11-2
11.3.3 Additional Investigations	11-5
11.3.4 Aerial Photographic Investigation	11-9
11.4 Remedial Investigation Objectives	11-11
12.0 STUDY AREA INVESTIGATIONS	12-1
12.1 Site Survey	12-1
12.2 Soil Investigation	12-1
12.2.1 Drilling Procedures	12-1
12.2.2 Sampling Locations	12-2
12.2.3 Sampling Procedures	12-3
12.2.4 Analytical Program	12-3
12.2.5 Quality Assurance and Quality Control	12-4
12.2.6 Air Monitoring and Field Screening	12-4

TABLE OF CONTENTS
(Continued)

	<u>Page</u>
12.3	Groundwater Investigation 12-4
12.3.1	Monitoring Well Installation 12-5
12.3.2	Monitoring Well Development 12-6
12.3.3	Water Level Measurements 12-6
12.3.4	Sampling Locations 12-6
12.3.5	Sampling Procedures 12-7
12.3.6	Analytical Program 12-8
12.3.7	Quality Assurance and Quality Control 12-9
12.3.8	Field Screening and Air Monitoring 12-9
12.3.9	Well Abandonment 12-9
12.4	Surface Water and Sediment Investigation 12-9
12.4.1	Sampling Locations 12-9
12.4.2	Sampling Procedures 12-10
12.4.3	Analytical Program 12-10
12.4.4	Quality Assurance and Quality Control 12-10
12.5	Aquatic and Ecological Survey 12-10
12.5.1	Media Types 12-10
12.5.2	Sampling Locations 12-11
12.5.3	Sampling Procedures 12-11
12.5.4	Analytical Program 12-13
12.6	Decontamination Procedures 12-13
12.7	Investigation Derived Waste (IDW) Handling 12-14
13.0	SITE PHYSICAL CHARACTERISTICS 13-1
13.1	Topography 13-1
13.2	Surface Water Hydrology and Drainage Features 13-1
13.3	Subsurface Soil Conditions 13-1
13.3.1	Geology 13-1
13.3.2	Surface Soils 13-2
13.4	Hydrogeology 13-3
13.5	Ecology 13-4
13.6	Identification of Water Supply Wells 13-6
14.0	NATURE AND EXTENT OF CONTAMINATION 14-1
14.1	Data Quality 14-1
14.1.1	Data Management and Tracking 14-1
14.2	Non-Site Related Analytical Results 14-2
14.2.1	Laboratory Contaminants 14-2
14.2.2	Naturally-Occurring Inorganic Contaminants 14-3
14.3	Analytical Results 14-5
14.3.1	Soil Investigation 14-5

TABLE OF CONTENTS
(Continued)

	<u>Page</u>
14.3.2	Groundwater Investigation 14-8
14.3.3	Surface Water Investigation 14-11
14.3.4	Sediment Investigation 14-12
14.3.5	Aquatic Investigation 14-15
14.4	Extent of Contamination 14-16
14.4.1	Extent of Soil Contamination 14-16
14.4.2	Extent of Groundwater Contamination 14-18
14.4.3	Extent of Surface Water Contamination 14-19
14.4.4	Extent of Sediment Contamination 14-20
15.0	CONTAMINANT FATE AND TRANSPORT 15-1
15.1	Chemical and Physical Properties Impacting Fate and Transport 15-1
15.2	Contaminant Transport Pathways 15-2
15.2.1	On-Site Deposition of Windblown Dust 15-3
15.2.2	Leaching of Sediment Contaminants to Surface Water 15-3
15.2.3	Leaching of Soil Contaminants to Groundwater 15-4
15.2.4	Migration of Groundwater Contaminants 15-4
15.3	Fate and Transport Summary 15-6
15.3.1	Volatile Organic Compounds 15-6
15.3.2	Polynuclear Aromatic Hydrocarbons 15-7
15.3.3	Pesticides/Polychlorinated Biphenyls 15-7
15.3.4	Inorganics 15-8
16.0	BASELINE HUMAN HEALTH RISK ASSESSMENT 16-1
16.1	Introduction 16-1
16.2	Hazard Identification 16-2
16.2.1	Data Evaluation and Reduction 16-2
16.2.2	Identify Data Suitable for Use in a Quantitative Risk Assessment . 16-3
16.2.3	Criteria Used in Selection of COPCs 16-3
16.2.4	Contaminants of Potential Concern (COPCs) 16-6
16.3	Exposure Assessment 16-11
16.3.1	Potential Human Receptors and Adjacent Populations 16-12
16.3.2	Exposure Pathways 16-13
16.3.3	Quantification of Exposure 16-16
16.3.4	Calculation of Chronic Daily Intakes 16-17
16.4	Toxicity Assessment 16-29
16.4.1	Carcinogenic Slope Factor 16-30
16.4.2	Reference Dose 16-30
16.4.3	Lead 16-32
16.4.4	Dermal Adjustment of Toxicity Factors 16-32
16.5	Risk Characterization 16-32

TABLE OF CONTENTS
(Continued)

	<u>Page</u>
16.5.1 Human Health Risks	16-33
16.6 Standard/Criteria/TBCs Comparison Results	16-35
16.6.1 Surface Soil	16-35
16.6.2 Subsurface Soil	16-36
16.6.3 Groundwater	16-36
16.6.4 Surface Water - New River	16-36
16.6.5 Surface Water - Cogdels Creek	16-37
16.6.6 Surface Water - Orde Pond	16-37
16.6.7 Sediment	16-38
16.6.8 Lead UBK Model Results	16-38
16.8 Sources of Uncertainty	16-38
16.8.1 Analytical Data Uncertainty	16-38
16.8.2 Exposure Assessment Uncertainty	16-39
16.8.3 Sampling Strategy Uncertainty	16-40
16.8.4 Toxicity Assessment Uncertainty	16-40
16.9 Conclusions of BRA for Site 28	16-41
17.0 ECOLOGICAL RISK ASSESSMENT	17-1
17.1 Introduction	17-1
17.1.1 Objectives of the Ecological Risk Assessment	17-1
17.1.2 Scope of the Ecological Risk Assessment	17-1
17.1.3 Organization of the Ecological Risk Assessment	17-2
17.2 Problem Formulation	17-2
17.2.1 Stressor Characteristics	17-3
17.2.2 Ecosystems Potentially at Risk	17-9
17.2.3 Ecological Effects	17-9
17.2.4 Ecological Endpoints	17-10
17.2.5 The Conceptual Model	17-15
17.3 Analysis Phase	17-16
17.3.1 Characterization of Exposure	17-16
17.3.2 Ecological Effects Characterization	17-29
17.4 Risk Characterization	17-42
17.4.1 Surface Water	17-43
17.4.2 Sediment	17-43
17.4.3 Surface Soil	17-45
17.4.4 Fish	17-45
17.4.5 Benthic Macroinvertebrate	17-46
17.4.6 Terrestrial Chronic Daily Intake Model	17-47
17.4.7 Other Sensitive Environments	17-48
17.5 Ecological Significance	17-49
17.5.1 Aquatic Endpoints	17-49

TABLE OF CONTENTS
(Continued)

	<u>Page</u>
17.5.2 Terrestrial Endpoint	17-49
17.6 Uncertainty Analysis	17-50
17.7 Conclusions	17-52
17.7.1 Aquatic Ecosystem	17-52
17.7.2 Terrestrial Ecosystem	17-52
18.0 CONCLUSIONS	18-1
 VOLUME III - SITE 30 (SEPARATE DOCUMENT)	
19.0 INTRODUCTION	19-1
20.0 SITE BACKGROUND AND SETTING	20-1
20.1 Site Description	20-1
20.2 Site History	20-1
20.3 Previous Investigations	20-1
20.3.1 Initial Assessment Study	20-1
20.3.2 Confirmation Study	20-2
20.3.3 Additional Investigations	20-3
20.3.4 Aerial Photographic Investigation	20-3
20.4 Remedial Investigation Objectives	20-4
21.0 STUDY AREA INVESTIGATIONS	21-1
21.1 Site Survey	21-1
21.2 Soil Investigation	21-1
21.2.1 Drilling Procedures	21-1
21.2.2 Sampling Locations	21-2
21.2.3 Sampling Procedures	21-2
21.2.4 Analytical Program	21-3
21.2.5 Quality Assurance and Quality Control	21-3
21.2.6 Air Monitoring and Field Screening	21-4
21.3 Groundwater Investigation	21-4
21.3.1 Monitoring Well Installation	21-4
21.3.2 Monitoring Well Development	21-5
21.3.3 Water Level Measurements	21-5
21.3.4 Sampling Locations	21-6
21.3.5 Sampling Procedures	21-6
21.3.6 Analytical Program	21-7
21.3.7 Quality Assurance and Quality Control	21-7
21.3.8 Field Screening and Air Monitoring	21-7
21.4 Surface Water and Sediment Investigation	21-8

TABLE OF CONTENTS
(Continued)

	<u>Page</u>
21.4.1	21-8
21.4.2	21-8
21.4.3	21-8
21.4.4	21-9
21.5	21-9
21.6	21-9
22.0	22-1
22.1	22-1
22.2	22-1
22.3	22-1
22.3.1	22-1
22.3.2	22-1
22.4	22-2
22.5	22-2
22.6	22-3
23.0	23-1
23.1	23-1
23.1.1	23-1
23.2	23-2
23.2.1	23-2
23.2.2	23-3
23.3	23-5
23.3.1	23-5
23.3.2	23-6
23.3.3	23-7
23.3.4	23-7
23.4	23-8
23.4.1	23-8
23.4.2	23-8
23.4.3	23-9
23.4.4	23-10
24.0	24-1
24.1	24-1
24.2	24-2
24.2.1	24-3
24.2.2	24-3
24.2.3	24-3
24.2.4	24-3

TABLE OF CONTENTS
(Continued)

		<u>Page</u>
24.3	Fate and Transport Summary	24-6
24.3.1	Volatile Organic Compounds	24-6
24.3.2	Polynuclear Aromatic Hydrocarbons	24-6
24.3.3	Pesticides/Polychlorinated Biphenyls	24-7
24.3.4	Inorganics	24-7
25.0	BASELINE HUMAN HEALTH RISK ASSESSMENT	25-1
25.1	Introduction	25-1
25.2	Hazard Identification	25-2
25.2.1	Data Evaluation and Reduction	25-2
25.2.2	Identify Data Suitable for Use in a Quantitative Risk Assessment ..	25-3
25.2.3	Criteria Used in Selection of COPCs	25-3
25.2.4	Contaminants of Potential Concern (COPCs)	25-6
25.3	Exposure Assessment	25-8
25.3.1	Potential Human Receptors and Adjacent Populations	25-8
25.3.2	Exposure Pathways	25-9
25.3.3	Quantification of Exposure	25-12
25.3.4	Calculation of Chronic Daily Intakes	25-13
25.4	Toxicity Assessment	25-23
25.4.1	Carcinogenic Slope Factor	25-24
25.4.2	Reference Dose	25-25
25.4.3	Dermal Adjustment of Toxicity Factors	25-26
25.5	Risk Characterization	25-26
25.5.1	Human Health Risks	25-27
25.6	Standards/Criteria/TBC Comparison Results	25-28
25.6.1	Surface Soil	25-28
25.6.2	Subsurface Soil	25-28
25.6.3	Groundwater	25-29
25.6.4	Surface Water	25-29
25.7	Sources of Uncertainty	25-29
25.7.1	Analytical Data Uncertainty	25-29
25.7.2	Exposure Assessment Uncertainty	25-30
25.7.3	Sampling Strategy Uncertainty	25-31
25.7.4	Toxicity Assessment Uncertainty	25-31
25.7	Conclusions of BRA for Site 30	25-32
26.0	ECOLOGICAL RISK ASSESSMENT	26-1
26.1	Introduction	26-1
26.1.1	Objectives of the Ecological Risk Assessment	26-1
26.1.2	Scope of the Ecological Risk Assessment	26-1
26.1.3	Organization of The Ecological Risk Assessment	26-2

TABLE OF CONTENTS
(Continued)

	<u>Page</u>
26.2	Problem Formulation 26-2
26.2.1	Stressor Characteristics 26-3
26.2.2	Ecosystems Potentially at Risk 26-6
26.2.3	Ecological Effects 26-6
26.2.4	Ecological Endpoints 26-7
26.2.5	The Conceptional Model 26-9
26.3	Analysis Phase 26-9
26.3.1	Characterization of Exposure 26-10
26.3.2	Ecological Effects Characterization 26-13
26.4	Risk Characterization 26-18
26.4.1	Surface Water 26-18
26.4.2	Sediment 26-19
26.4.3	Terrestrial Chronic Daily Intake Model 26-19
26.4.4	Other Sensitive Environments 26-20
26.5	Ecological Significance 26-20
26.5.1	Aquatic Endpoints 26-21
26.5.2	Terrestrial Endpoints 26-21
26.6	Uncertainty Analysis 26-21
26.7	Conclusions 26-22
26.7.1	Aquatic Ecosystem 26-22
26.7.2	Terrestrial Ecosystem 26-23
27.0	CONCLUSIONS 27-1
28.0	REFERENCES 28-1

APPENDICES

Volume I - Appendix A through Appendix I

- A Test Boring Records
- B Test Boring and Well Construction Records
- C Chain-of-Custody Forms
- D Field Well Development Records
- E Investigation Derived Waste Summary and Recommendations
- F Field Duplicate Summaries
- G TCLP Results
- H Grain Size and Wet Chemistry Results
- I QA/QC Summary

Volume II - Appendix J through Appendix L

- J Sampling Summary
- K Data and Frequency Summaries
- L Statistical Summaries

Volume III - Appendix M through Appendix U

- M Base Background
- N White Oak River Basin Reference Station
- O Shower Model
- P Lead UBK Model
- Q Site Conceptual Model
- R CDI Calculations
- S Summary of Groundwater Data and Aquifer Characteristics at MCB Camp Lejeune
- T Sampling Station Characterization Data Sheet
- U Biota Population

Note: All tables and figures will be presented in the back of each section - not within the body of the text.

LIST OF TABLES

Number

- 1-1 Climatic Data Summary, Marine Corps Air Station, New River
- 1-2 Geologic and Hydrogeologic Units of North Carolina's Coastal Plain
- 1-3 Protected Species within MCB, Camp Lejeune

- 2-1 Summary of Monitoring Well Construction Details, Confirmation Study - Site 1
- 2-2 Detected Target Contaminants in Groundwater, Confirmation Study - Site 1
- 2-3 Inorganic Contaminants in Groundwater, Remedial Investigation Scoping - Site 1
- 2-4 Summary of Remedial Investigation Objectives - Site 1

- 3-1 Soil Sampling Summary, Test Borings - Southern Disposal Area - Site 1
- 3-2 Soil Sampling Summary, Test Borings - Northern Disposal Area - Site 1
- 3-3 Soil Sampling Summary, Monitoring Well Test Borings - Site 1
- 3-4 Quality Assurance/Quality Control Sampling Program - Soil Investigation - Site 1
- 3-5 Summary of Well Construction Details - Site 1
- 3-6 Summary of Groundwater Field Parameters - Site 1
- 3-7 Groundwater Sampling Summary - Site 1
- 3-8 Quality Assurance/Quality Control Sampling Program - Groundwater Investigation - Site 1

- 4-1 Summary of Soil Physical Properties - Site 1
- 4-2 Summary of Water Level Measurements on March 19, 1994 and May 9, 1994 - Site 1
- 4-3 Summary of Habitat Types - Site 1
- 4-4 Summary of Potable Water Supply Wells Within a One-Mile Radius - Site 1

- 5-1 Summary of Rejected Data - Site 1
- 5-2 Summary of Site Contamination - Site 1
- 5-3 Surface Soil - Positive Detection Summary, TCL Organics - Site 1
- 5-4 Surface Soil - Positive Detection Summary, Total Metals - Site 1
- 5-5 Subsurface Soil - Positive Detection Summary, TCL Organics - Site 1
- 5-6 Subsurface Soil - Positive Detection Summary, Total Metals - Site 1
- 5-7 Shallow and Deep Groundwater - Positive Detection Summary, TCL Organics (Round 1) - Site 1
- 5-8 Shallow and Deep Groundwater - Positive Detection Summary, Total Metals (Round 1) - Site 1
- 5-9 Shallow and Deep Groundwater - Positive Detection Summary, Dissolved Metals (Round 1) - Site 1
- 5-10 Shallow and Deep Groundwater - Positive Detection Summary, TCL Organics (Round 2) - Site 1
- 5-11 Shallow and Deep Groundwater - Positive Detection Summary, Total Metals (Round 2) - Site 1
- 5-12 Shallow and Deep Groundwater - Positive Detection Summary, Dissolved Metals (Round 2) - Site 1
- 5-13 Comparison of Groundwater Analytical Results - Site 1

LIST OF TABLES
(Continued)

Number

- 6-1 Organic Physical and Chemical Properties
- 6-2 Processes Influencing Fate of Organic Pollutants
- 6-3 Relative Mobilities of Inorganics as a Function of Environmental Conditions (Eh, pH)

- 7-1 Summary of Standards/Criteria Comparison Results for Total Metals in Surface Soil
- 7-2 Summary of Standards/Criteria Comparison Results for Total Metals in Subsurface Soil
- 7-3 Summary of Standards/Criteria Comparison Results for Total Metals in Shallow and Deep Groundwater
- 7-4 Summary of Standards/Criteria Comparison Results for Organics in Shallow and Deep Groundwater
- 7-5 Summary of Contaminants of Potential Concern (COPCs) Surface Soil, Subsurface Soil and Shallow and Deep Groundwater
- 7-6 Summary of Exposure Dose Input Parameters
- 7-7 Summary of Exposure Pathways
- 7-8 Summary of Health-Based Criteria
- 7-9 Summary of Dermal-Adjusted Health-Based Criteria
- 7-10 Summary of Potential Risks
- 7-11 Summary of COPCs Contributing to Risks

- 8-1 List of Contaminants Detected in the Surface Soil Samples
- 8-2 Summary of Contaminants of Potential Concern (COPCs)
- 8-3 Physical/Chemical Characteristics of the COPCs
- 8-4 Terrestrial Reference Values and Soil to Plant Transfer Coefficients
- 8-5 Terrestrial Chronic Daily Intake Model Exposure Parameters
- 8-6 Quotient Index Ratios, Terrestrial Model

- 11-1 Summary of Monitoring Well Construction Details, Confirmation Study - Site 28
- 11-2 Detected Target Contaminants in Groundwater, Confirmation Study - Site 28
- 11-3 Detected Target Contaminants in Sediment, Confirmation Study - Site 28
- 11-4 Inorganic Contaminants in Groundwater, Remedial Investigation Scoping - Site 28
- 11-5 Summary of Remedial Investigation Objectives - Site 28

- 12-1 Soil Sampling Summary, Test Borings - Western Disposal Area - Site 28
- 12-2 Soil Sampling Summary, Test Borings - Eastern Disposal Area - Site 28
- 12-3 Soil Sampling Summary, Monitoring Well Test Borings - Site 28
- 12-4 Quality Assurance/Quality Control Sampling Program - Soil Investigation - Site 28
- 12-5 Summary of Well Construction Details - Site 28
- 12-6 Summary of Groundwater Field Parameters - Site 28
- 12-7 Groundwater Sampling Summary - Site 28
- 12-8 Quality Assurance/Quality Control Sampling Program - Groundwater Investigation - Site 28
- 12-9 Summary of Field Water Quality Parameters - Site 28

LIST OF TABLES
(Continued)

Number

- 12-10 Surface Water and Sediment Sampling Summary - Site 28
- 12-11 Quality Assurance/Quality Control Sampling Program - Surface Water and Sediment Investigation - Site 28
- 12-12 Summary of Surface Water Quality Parameters - Site 28

- 13-1 Summary of Staff Gauge Readings, March 19, 1994 and May 10, 1994 - Site 28
- 13-2 Summary of Soil Physical Properties - Site 28
- 13-3 Summary of Water Level Measurements on March 19, 1994 and May 10, 1994 - Site 28
- 13-4 Summary of Habitat Types - Site 28

- 14-1 Summary of Rejected Data - Site 28
- 14-2 Summary of Site contamination - Site 28
- 14-3 Surface Soils - Positive Detection Summary, TCL Organics - Site 28
- 14-4 Surface Soils - Positive Detection Summary, Total Metals - Site 28
- 14-5 Subsurface Soils - Positive Detection Summary, TCL Organics - Site 28
- 14-6 Subsurface Soils - Positive Detection Summary, Total Metals - Site 28
- 14-7 Shallow and Deep Groundwater - Positive Detection Summary, TCL Organics (Round 1) - Site 28
- 14-8 Shallow and Deep Groundwater - Positive Detection Summary, Total Metals (Round 1) - Site 28
- 14-9 Shallow and Deep Groundwater - Positive Detection Summary, Dissolved Metals (Round 1) - Site 28
- 14-10 Shallow and Deep Groundwater - Positive Detection Summary, Total Metals (Round 2) - Site 28
- 14-11 Shallow and Deep Groundwater - Positive Detection Summary, Dissolved Metals (Round 2) - Site 28
- 14-12 Comparison of Groundwater Analytical Results - Site 28
- 14-13 Surface Water - Positive Detection Summary, TCL Organics (Orde Pond) - Site 28
- 14-14 Surface Water - Positive Detection Summary, Total Metals (Orde Pond) - Site 28
- 14-15 Surface Water - Positive Detection Summary, TCL Organics (Cogdels Creek) - Site 28
- 14-16 Surface Water - Positive Detection Summary, Total Metals (Cogdels Creek) - Site 28
- 14-17 Surface Water - Positive Detection Summary, TCL Organics (New River) - Site 28
- 14-18 Surface Water - Positive Detection Summary, Total Metals (New River) - Site 28
- 14-19 Sediment - Positive Detection Summary, TCL Organics (Orde Pond) - Site 28
- 14-20 Sediment - Positive Detection Summary, Total Metals (Orde Pond) - Site 28
- 14-21 Sediment - Positive Detection Summary, TCL Organics (Cogdels Creek) - Site 28
- 14-22 Sediment - Positive Detection Summary, Total Metals (Cogdels Creek) - Site 28
- 14-23 Sediment - Positive Detection Summary, TCL Organics (New River) - Site 28
- 14-24 Sediment - Positive Detection Summary, Total Metals (New River) - Site 28
- 14-25 Fish Tissue (Whole Body) - Positive Detection Summary, TCL Organics (Orde Pond) - Site 28

LIST OF TABLES
(Continued)

Number

- 14-26 Fish Tissue (Whole Body) - Positive Detection Summary, Total Metals (Orde Pond) - Site 28
- 14-27 Fish Tissue (Fillets) - Positive Detection Summary, TCL Organics (Orde Pond) - Site 28
- 14-28 Fish Tissue (Fillets) - Positive Detection Summary, Total Metals (Orde Pond) - Site 28
- 14-29 Fish Tissue (Whole Body) - Positive Detection Summary, TCL Organics (New River) - Site 28
- 14-30 Fish Tissue (Whole Body) - Positive Detection Summary, Total Metals (New River) - Site 28
- 14-31 Fish Tissue (Fillets) - Positive Detection Summary, TCL Organics (New River) - Site 28
- 14-32 Fish Tissue (Fillets) - Positive Detection Summary, Total Metals (New River) - Site 28

- 15-1 Organic Physical and Chemical Properties
- 15-2 Processes Influencing Fate of Organic Pollutants
- 15-3 Relative Mobilities of Inorganics as a Function of Environmental Conditions (Eh, pH)

- 16-1 Summary of Standards/Criteria Comparison Results for Total Metals in Surface Soil
- 16-2 Summary of Standards/Criteria Comparison Results for Total Metals in Subsurface Soil
- 16-3 Summary of Standards/Criteria Comparison Results for Total Metals in Shallow and Deep Groundwater
- 16-4 Summary of Standards/Criteria Comparison Results for Organics in Shallow and Deep Groundwater
- 16-5 Summary of Standards/Criteria Comparison Results for Total Metals in Surface Water and Sediment - New River, Cogdels Creek and Orde Pond
- 16-6 Summary of Standards/Criteria Comparison results for Total Metals in Sediment - New River, Cogdels Creek, and Orde Pond
- 16-7 Summary of Contaminants of Potential Concern (COPCs) Surface Soil, Subsurface Soil, Shallow and Deep Groundwater, Surface Water, Sediment, and Fish Tissue
- 16-8 Summary of Exposure Dose Input Parameters
- 16-9 Summary of Exposure Pathways
- 16-10 Summary of Health-Based Criteria
- 16-11 Summary of Dermal-Adjusted Health-Based Criteria
- 16-12 Summary of Potential Risks for the Child Receptor
- 16-13 Summary of Potential Risks for the Adult Receptor
- 16-14 Summary of Potential Risks for the Military, Fisherman and Construction Worker Receptors
- 16-15 Summary of COPCs Contributing to Risks

- 17-1 List of Contaminants Detected in the Surface Water, Sediment, Surface Soil and Biota Samples
- 17-2 Summary of Contaminants of Potential Concern (COPCs)
- 17-3 Physical/Chemical Characteristics of the COPCs
- 17-4 Total Number of Aquatic Species Identified Per Area

LIST OF TABLES
(Continued)

Number

- 17-5 Summary of Ecological Samples Sent to Ceimic for Tissue Analysis
- 17-6 Fish Distribution and Characterization
- 17-7 Systematic List of Benthic Macroinvertebrate Species
- 17-8 Biotic Index and USEPA Tolerance to Organic Waste and Sensitivity to Metals for Benthic Macroinvertebrate Species
- 17-9 Summary Statistics of Benthic Macroinvertebrate Species at New River, Cogdels Creek and Orde Pond
- 17-10 Frequency and Range of Detection Compared to Saltwater North Carolina WQs, USEPA WQSVs, and USEPA AWQC - New River
- 17-11 Frequency and Range of Detection Compared to Saltwater North Carolina WQs, USEPA WQSVs, and USEPA AWQC - Cogdels Creek
- 17-12 Frequency and Range of Detection Compared to Freshwater North Carolina WQs, USEPA WQSVs, and USEPA AWQC - Orde Pond
- 17-13 Frequency and Range of Detection Compared to Sediment Screening Values - New River
- 17-14 Frequency and Range of Detection Compared to Sediment Screening Values - Cogdels Creek
- 17-15 Frequency and Range of Detection Compared to Sediment Screening Values - Orde Pond
- 17-16 Results of the Jaccard Coefficient (Sj) of Community Similarity and Sørensen Index (Ss) of Community Similarity Between Benthic Macroinvertebrate Stations at The New River, Hadnot Creek and Holland Mill Creek
- 17-17 Results of the Jaccard Coefficient (Sj) of Community Similarity and Sørensen Index (Ss) of Community Similarity Between Benthic Macroinvertebrate Stations at Cogdels Creek, Webb Creek, Hadnot Creek and Holland Mill Creek
- 17-18 Results of the Jaccard Coefficient (Sj) of Community Similarity and Sørensen Index (Ss) of Community Similarity Between Benthic Macroinvertebrate Stations at Orde Pond and Hadnot Creek
- 17-19 Terrestrial Reference Values and Soil to Plant Transfer Coefficients
- 17-20 Terrestrial Chronic Daily Intake Model Exposure Parameters
- 17-21 Surface Water Quotient Index
- 17-22 Sediment Screening Values Quotient Index
- 17-23 Quotient Index Ratios, Terrestrial Model

- 20-1 Summary of Monitoring Well Construction Details, Confirmation Study - Site 30
- 20-2 Detected Target Contaminants in Groundwater, Confirmation Study - Site 30
- 20-3 Summary of Remedial Investigation Objectives - Site 30

- 21-1 Soil Sampling Summary - Site 30
- 21-2 Quality Assurance/Quality Control Sampling Program - Soil Investigation - Site 30
- 21-3 Summary of Well Construction Details - Site 30
- 21-4 Summary of Groundwater Field Parameters - Site 30
- 21-5 Groundwater Sampling Summary - Site 30

LIST OF TABLES
(Continued)

Number

- 21-6 Quality Assurance/Quality Control Sampling Program - Groundwater Investigation - Site 30
- 21-7 Summary of Field Water Quality Parameters - Site 30
- 21-8 Surface Water and Sediment Sampling Summary - Site 30
- 21-9 Quality Assurance/Quality Control Sampling Program - Surface Water and Sediment Investigation - Site 30
-
- 22-1 Summary of Staff Gauge Readings, March 19, 1994 and May 10, 1994 - Site 30
- 22-2 Summary of Soil Physical Properties - Site 30
- 22-3 Summary of Water Level Measurements on March 19, 1994 and May 9, 1994 - Site 30
- 22-4 Summary of Habitat Types - Site 30
- 22-5 Summary of Potable Water Supply Wells Within the Vicinity of Site 30
-
- 23-1 Summary of Site Contamination - Site 30
- 23-2 Surface Soil - Positive Detection Summary, Volatiles and Semivolatiles - Site 30
- 23-3 Surface Soil - Positive Detection Summary, Total Metals - Site 30
- 23-4 Subsurface Soil - Positive Detection Summary, Volatiles and Semivolatiles - Site 30
- 23-5 Subsurface Soil - Positive Detection Summary, Total Metals - Site 30
- 23-6 Groundwater - Positive Detection Summary, Volatiles and Semivolatiles (Round 1) - Site 30
- 23-7 Groundwater - Positive Detection Summary, Total Metals (Round 1) - Site 30
- 23-8 Groundwater - Positive Detection Summary, Dissolved Metals (Round 1) - Site 30
- 23-9 Groundwater - Positive Detection Summary, Volatiles and Semivolatiles (Round 2) - Site 30
- 23-10 Groundwater - Positive Detection Summary, Total Metals (Round 2) - Site 30
- 23-11 Groundwater - Positive Detection Summary, Dissolved Metals (Round 2) - Site 30
- 23-12 Comparison of Groundwater Analytical Results - Site 30
- 23-13 Surface Water - Positive Detection Summary, Total Metals - Site 30
- 23-14 Sediment - Positive Detection Summary, Volatiles and Semivolatiles - Site 30
- 23-15 Sediment - Positive Detection Summary, Total Metals - Site 30
-
- 24-1 Organic Physical and Chemical Properties
- 24-2 Process Influencing Fate of Organic Pollutants
- 24-3 Relative Mobilities of Inorganics as a Function of Environmental Conditions (Eh, pH)
-
- 25-1 Summary of Standards/Criteria Comparison Results for Total Metals in Surface Soil
- 25-2 Summary of Standards/Criteria Comparison Results for Total Metals in Subsurface Soil
- 25-3 Summary of Standards/Criteria Comparison Results for Total Metals in Groundwater
- 25-4 Summary of Standards/Criteria Comparison Results for Organics in Groundwater
- 25-5 Summary of Standards/Criteria Comparison Results for Total Metals in Surface Water
- 25-6 Summary of Standards/Criteria comparison Results for Total Metals in Sediment

LIST OF TABLES
(Continued)

Number

- 25-7 Summary of Contaminants of Potential Concern (COPCs) Surface Soil, Subsurface Soil, Groundwater, Surface Water and Sediment
- 25-8 Summary of Exposure Dose Input Parameters
- 25-9 Summary of Exposure Pathways
- 25-10 Summary of Health-Based Criteria
- 25-11 Summary of Dermal-Adjusted Health-Based Criteria
- 25-12 Summary of Potential Risks

- 26-1 List of Contaminants Detected in the Surface Water, Sediment and Surface Soil
- 26-2 Summary of Contaminants of Potential Concern (COPCs)
- 26-3 Physical/Chemical Characteristics of the COPCs
- 26-4 Frequency and Range of Detection Compared to Freshwater North Carolina WQSs, USEPA WQSVs, and USEPA AWQC
- 26-5 Frequency and Range of Detection Compared to Sediment Screening Values
- 26-6 Terrestrial Reference Values and Soil to Plant Transfer Coefficients
- 26-7 Terrestrial Chronic Daily Intake Model Exposure Parameters
- 26-8 Surface Water Quotient Index
- 26-9 Quotient Index Ratios, Terrestrial Model

LIST OF FIGURES

Number

- 1-1 Operable Unit No. 7 - Sites 1, 28, and 30
- 1-2 Operable Units and Site Locations
- 1-3 Location of Hydrogeologic Cross-Sections, Marine Corps Base Camp Lejeune
- 1-4 Hydrogeologic Cross-Sections of MCB, Camp Lejeune Area

- 2-1 Site Map, Site 1 - French Creek Liquids Disposal Area
- 2-2 Sampling Locations, Confirmation Study - Site 1
- 2-3 Aerial Photograph, October 1949 - Site 1
- 2-4 Aerial Photograph, November 1960 - Site 1
- 2-5 Aerial Photograph, January 1984 - Site 1

- 3-1 Surface and Subsurface Sampling Locations - Site 1
- 3-2 Shallow and Deep Monitoring Well Locations - Site 1
- 3-3 Typical Shallow Type II Groundwater Monitoring Well Construction Diagram
- 3-4 Typical Deep Type II Groundwater Monitoring Well Construction Diagram

- 4-1 Geologic Cross-Section Location Map - Site 1
- 4-2 Geologic Cross-Section A-A', Shallow Soil Lithology - Site 1
- 4-3 Geologic Cross-Section B-B', Shallow Soil Lithology - Site 1
- 4-4 Geologic Cross-Section C-C', Shallow Soil Lithology - Site 1
- 4-5 Geologic Cross-Section D-D', Shallow Soil Lithology - Site 1
- 4-6 Geologic Cross-Section E-E', Deep Soil Lithology - Site 1
- 4-7 Groundwater Contour Map for the Surficial Aquifer, May 9, 1994 - Site 1
- 4-8 Biohabitat Map - Site 1
- 4-9 Potable Water Supply Wells Within a One-Mile Radius - Site 1

- 5-1 Positive Detections of Organic Compounds in Surface Soils - Site 1
- 5-2 Positive Detections of Organic Compounds in Subsurface Soils - Site 1
- 5-3 Positive Detections of Organic Compounds in Groundwater - Site 1

- 7-1 Flowchart of Potential Exposure Pathways and Receptors - Site 1

- 11-1 Site Map, Site 28 - Hadnot Point Burn Dump
- 11-2 Sample Locations, Confirmation Study - Site 28
- 11-3 Surface Water and Sediment Stations - Hadnot Point Development Area
- 11-4 Aerial Photograph, October 1949 - Site 28
- 11-5 Aerial Photograph, February 1952 - Site 28
- 11-6 Aerial Photograph, February 1956 - Site 28
- 11-7 Aerial Photograph, November 1960 - Site 28
- 11-8 Aerial Photograph, February 1964 - Site 28

- 12-1 Surface and Subsurface Sampling Locations - Site 28
- 12-2 Shallow and Deep Monitoring Well Locations - Site 28

LIST OF FIGURES

(Continued)

Number

- 12-3 Typical Shallow Type II Groundwater Monitoring Well Construction Diagram
- 12-4 Typical Deep Type II Groundwater Monitoring Well Construction Diagram
- 12-5 Surface Water and Sediment Sampling Locations - Site 28
- 12-6 Aquatic Survey Sampling Locations - Site 28

- 13-1 Geologic Cross-Section Location Map - Site 28
- 13-2 Geologic Cross-Section A-A', Shallow Soil Lithology - Site 28
- 13-3 Geologic Cross-Section B-B', Shallow Soil Lithology - Site 28
- 13-4 Geologic Cross-Section C-C', Shallow Soil Lithology - Site 28
- 13-5 Geologic Cross-Section D-D', Shallow Soil Lithology - Site 28
- 13-6 Geologic Cross-Section E-E', Deep Soil Lithology - Site 28
- 13-7 Geologic Cross-Section F-F', Deep Soil Lithology - Site 28
- 13-8 Groundwater Contour Map for the Surficial Aquifer, May 10, 1994 - Site 28
- 13-9 Groundwater Contour Map for the Deep Aquifer, May 10, 1994 - Site 28
- 13-10 Biohabitat Map - Site 28

- 14-1 Positive Detections of Organic Compounds in Surface Soils - Site 28
- 14-2 Positive Detections of Organic Compounds in Subsurface Soils - Site 28
- 14-3 Positive Detections of Organic Compounds in Groundwater - Site 28
- 14-4 Positive Detections of TAL Metals Above Federal MCL and/or NCWQS in Groundwater - Site 28
- 14-5 Positive Detections of Organic Compounds in Surface Water - Site 28
- 14-6 Positive Detections of TAL Metals Above Federal Screening Values in Surface Water - Site 28
- 14-7 Positive Detections of Organic Compounds in Sediments - Site 28
- 14-8 Positive Detections of TAL Metals Above Federal Screening Values in Sediment - Site 28

- 16-1 Flowchart of Potential Exposure Pathways and Receptors - Site 28
- 16-2 The Cumulative Probability Percent of Blood Lead Levels for Site 28, Hadnot Point Burn Dump-Current Scenario
- 16-3 The Probability Distribution of Blood Lead Levels for Site 28, Hadnot Point Burn Dump-Current Scenario
- 16-4 The Cumulative Probability Percent of Blood Lead Levels for Site 28, Hadnot Burn Dump-Future Scenario
- 16-5 The Probability Distribution of Blood Lead Levels for Site 28, Hadnot Point Burn Dump-Future Scenario

- 17-1 Surface Water and Sediment Quotient Ratio Exceedances for Site 28

- 20-1 Site Map, Site 30 - Sneads Ferry Road Fuel Tank Sludge Area
- 20-2 Sampling Locations, Confirmation Study - Site 30
- 20-3 Aerial Photograph, February 1964 - Site 30

LIST OF FIGURES
(Continued)

Number

- 21-1 Surface and Subsurface Soil Sampling Locations - Site 30
- 21-2 Shallow Monitoring Well Locations - Site 30
- 21-3 Typical Shallow Type II Groundwater Monitoring Well Construction Diagram
- 21-4 Surface Water and Sediment Sampling locations -Site 30

- 22-1 Geologic Cross-Section Location Map - Site 30
- 22-2 Geologic Cross-Section A-A', Shallow Soil Lithology - Site 30
- 22-3 Geologic Cross-Section B-B', Shallow Soil Lithology - Site 30
- 22-4 Groundwater Contour Map for the Surficial Aquifer May 9, 1994 - Site 30
- 22-5 Biohabitat Map - Site 30
- 22-6 Potable Water Supply Wells Within a One-Mile Radius - Site 30

- 23-1 Positive Detections of Volatile and Semivolatile Organic Compounds in Surface Soils - Site 30
- 23-2 Positive Detections of Volatile and Semivolatile Organic Compounds in Subsurface Soils - Site 30
- 23-3 Positive Detections of Volatile and Semivolatile Organic Compounds in Shallow Groundwater - Site 30
- 23-4 Positive Detections of TAL Metals above Federal Screening Values in Surface Water - Site 30
- 23-5 Positive Detections of Volatile and Semivolatile Organic Compounds in Sediment - Site 30

- 25-1 Flowchart of Potential Exposure Pathways and Receptors - Site 30

- 26-1 Surface Water and Sediment Quotient Ratio Exceedances for Site 30

LIST OF ACRONYMS AND ABBREVIATIONS

ARARs	applicable or relevant and appropriate requirements
ARV	Aquatic Reference Value
ATSDR	Agency for Toxic Substances and Disease Registry
ASTM	American Society for Testing Materials
AWQC	Ambient Water Quality Criteria
bgs	below ground surface
bls	below land surface
BOD	biological oxygen demand
BRA	baseline human health risk assessment
Carc.	Carcinogenic Effects
CDI	Chronic Daily Intake
CERCLA	Comprehensive Environmental Response, Compensation and Liability Act
CLEJ	Camp Lejeune
CLP	Contract Laboratory Program
COD	chemical oxygen demand
COPC	Contaminant of Potential Concern
CRAVE	Carcinogen Risk Assessment Verification Endeavor
CSF	Carcinogenic Slope Factor
DOD	Department of the Defense
DoN	Department of the Navy
DQO	Data Quality Objective
EMD	Environmental Management Division (Camp Lejeune)
ERA	Ecological Risk Assessment
ER-L	Effects Range - Low
ESE	Environmental Science and Engineering, Inc.
°F	degrees Fahrenheit
FFA	Federal Facilities Agreement
FMF	Fleet Marine Force
FMFLANT	Fleet Marine Force Atlantic
FFSG	Force Service Support Group
ft	feet
ft/ft	foot per foot
gpm	gallons per minute
GSRA	Greater Sandy Run Area
GW	groundwater well
HA	Health Advisories
HEAST	Health Effects Assessment Summary Tables

HHAG	Human Health Assessment Group
HI	hazard index
HPIA	Hadnot Point Industrial Area
HQ	hazard quotient
IAS	Initial Assessment Study
ICRs	Estimated Incremental Lifetime Cancer Risks
IRIS	Integrated Risk Information System
IRP	Installation Restoration Program
LANTDIV	Naval Facilities Engineering Command, Atlantic Division
LOAEL	lowest-observed-adverse-effect-level
MAGTF	Marine Air Ground Task Force
MCAS	Marine Corps Air Station
MCB	Marine Corps Base
MCL	maximum contaminant level
MF	Modifying Factor
mgd	million gallons per day
mg/L	milligram per liter
MILCON	Military Construction
msl	mean sea level
NACIP	Navy Assessment and Control of Installation Pollutants
NC DEHNR	North Carolina Department of Environment, Health, and Natural Resources
NCP	National Contingency Plan
NCWQS	North Carolina Water Quality Standard
ND	Nondetect
NEESA	Naval Energy and Environmental Support Activity
NOAA	National Oceanic Atmosphere Administration
NOAEL	no-observed-adverse-effect-level
NOEL	no-observed-effect level
Noncarc.	Noncarcinogenic Effects
NPDES	National Pollutant Discharge Elimination System
NPL	National Priorities List
NREA	Natural Resources and Environmental Affairs
OSWER	Office of Solid Waste and Emergency Response
OU	operable unit
PAH	polynuclear aromatic hydrocarbon
PCB	polychlorinated biphenyl
POTW	publicly owned treatment works
ppb	parts per billion
ppm	parts per million
PRAP	Proposed Remedial Action Plan
PRGs	Preliminary Remediation Goals

QA/QC	quality assurance/quality control
QI	Quotient Index
RBCs	Region II Risk Based Concentrations
RCRA	Resource Conservation and Recovery Act
RfD	reference dose
RI/FS	Remedial Investigation/Feasibility Study
RME	Responsible Maximum Exposure
ROD	Record of Decision
SAP	Sampling and Analysis Plan
SARA	Superfund Amendments and Reauthorization Act
Sj	Jaccard Coefficient
SMCL	Secondary Maximum Contaminant Level
SQC	Sediment Quality Criteria
Ss	Sørensen Index
SSV	Sediment Screening Value
SVOCs	Semivolatile Organic Compounds
TAL	Target Analyte List
TBC	To Be Considered
TCL	Target Compound List
TCLP	Toxicity Characteristics Leaching Procedure
TDS	total dissolved solids
TRV	Terrestrial Reference Value
TSS	total suspended solids
UBK	Uptake/Biokinetic
UCL	Upper Confidence Level
UF	Uncertainty Factor
µg/L	micrograms per liter
µg/kg	micrograms per kilogram
USEPA	United States Environmental Protection Agency
USGS	United States Geological Survey
VOCs	Volatile Organic Compounds
WAR	Water and Air Research, Inc.
WOE	weight-of-evidence
WQS	Water Quality Standards
WQSV	Water Quality Screening Values

EXECUTIVE SUMMARY

INTRODUCTION

The purpose of this Remedial Investigation (RI) is to evaluate the nature and extent of the threat to public health and the environment caused by the release or threatened release of hazardous substances, pollutants, or contaminants. The RI investigation was conducted by sampling several media (soil, groundwater, surface water, sediment, and fish tissue) at Operable Unit (OU) No. 7; evaluating the resultant analytical data; and performing a human health risk assessment (RA) and ecological RA. This RI report contains the results of all field investigations, the human health RA, and the ecological RA. Furthermore, the RI report provides information to support the Feasibility Study (FS) and record of decision (ROD) for a final remedial action.

Operable Unit Description

OU No. 7 is located on the eastern portion of the base, situated between the New River and Sneads Ferry Road, south of the Hadnot Point Industrial Area (HPIA). OU No. 7 includes Sites 1, 28 and 30. Site 1 is referred to as the French Creek Liquids Disposal Area, Site 28 is the Hadnot Point Burn Dump, and Site 30 is known as the Sneads Ferry Road Fuel Tank Sludge Area. Site 1 is located on both the north and south sides of Main Service Road, approximately one mile southeast of HPIA. Site 28 is located along the eastern shore of the New River, immediately south of the Julian C. Smith Boulevard and O Street intersection. Site 30 is located approximately 4-1/2 miles south of HPIA, along a tank trail that intersects Sneads Ferry Road from the southwest.

Site Description and History

Site 1

Site 1, the French Creek Liquids Disposal Area, is located approximately one mile east of the New River and one mile southeast of HPIA on the Mainside portion of MCB, Camp Lejeune. The site is situated on both the north and south sides of Main Service Road near the western edge of the Gun Park Area and Force Troops Complex.

The French Creek development area, which includes the Gun Park Area and Force Troops Complex, is a self-supportive, campus-like development. The supply, storage, and maintenance facilities, of which Site 1 is a part, are situated to the north of the housing areas and account for over 58 percent of the 583 total acres that constitute the French Creek development area. Most of the supply and storage facilities at MCB, Camp Lejeune are within this development area. Troop housing occupies nearly 21 percent of the developed area or approximately 122 acres. Ordnance storage areas are situated along Sneads Ferry Road, to the southeast of the French Creek Development Area (Master Plan, 1988).

The majority of Site 1 is comprised of paved (i.e., asphalt, concrete) or improved (i.e. coarse gravel) road surface, parking lots, storage lots, buildings, and equipment maintenance racks. The northern portion of the site is bordered to the north by woods and a motor-cross training area, to the east by a vehicle storage area associated with Building FC-100, to the south by Main Service Road, and to the west by woods and Building FC-115. A majority of the suspected northern disposal area is within two fenced compounds that are associated with Buildings FC-120 and FC-134. The

remaining portion of the northern disposal area is located outside of these fenced compounds, to the west and immediately adjacent to Building FC-134.

Building FC-120, located on the northern portion of the site, serves as a motor transport maintenance facility for the Second Landing Support Battalion. Building FC-134, located to the north of Building FC-120, provides offices and communication equipment storage also for the second battalion. Building FC-120 is a two-story, brick structure with several vehicle maintenance bays and offices; Building FC-134 is a single-story, brick structure also with offices and one garage bay.

Two equipment wash areas are located on the northern portion of the site. The first wash area is located to the east of Building FC-134 and the second lies to the west of Building FC-120. Both equipment wash areas are concrete-lined and employ an oil and water separator collection basin. Another oil and water separator is located to the north of Building FC-120, adjacent to Building SAC-118. Discharge from the three oil and water separators flows into a drainage ditch and sediment retention pond to the north of the study area.

A number of covered material storage areas (i.e., SAC-118, SAC-124, SAC-125, and SAC-145) are located to the north and west of Building FC-120. These smaller, covered structures are used for temporary storage of paint, compressed gasses, vehicle maintenance fluids, spent or contaminated materials, and batteries. In addition to these covered storage structures, an above-ground storage tank (AST) area, located adjacent to the northern side of Building FC-120, is utilized to store spent motor oil and ethylene glycol (i.e., anti-freeze). A gasoline service island is located to the west of Building FC-120; the two pumps provide fuel for vehicles undergoing maintenance at Building FC-120. An underground storage tank (UST) of unknown capacity is associated with this active service island.

The southern portion of the site is bordered by Main Service Road to the north, Daly Road and a wooded area to the east, H. M. Smith Boulevard to the south, and a wooded area and Gonzales Boulevard to the west. Vehicle access to the suspected southern disposal area is via a swing-arm gate along Main Service Road. A portion of the southern disposal area is surrounded by a barbed-wire fence and a vehicle and equipment Administrative Deadline Lot (ADL); the remaining area is not fenced.

The southern portion of the site has several buildings located adjacent to the suspected disposal area. The buildings are constructed of either formed metal, concrete block, or wood frame siding. Typically the buildings are set on a poured concrete slab and have raised seam metal roofs. These buildings house a number of support offices, recreation facilities, machine shops, light-duty vehicle and equipment maintenance bays, and equipment storage areas. Heat is provided to the majority of these buildings by kerosene-fired stoves; kerosene fuel is stored in several ASTs located beside each of the buildings.

Two vehicle maintenance ramps are located on the southern portion of the site. The first ramp is located immediately to the south of Building FC-739 and the second lies to the north of Building GP-19. Both maintenance ramps are constructed of concrete and are used for the upkeep of vehicles and equipment. Two oil and water separator collection basins are also located on the southern portion of the site. One of the separators is located adjacent to the Building FC-739 vehicle maintenance ramp, and the other is located to the south of Building FC-816, adjacent to an equipment wash area. Discharge from the separator and wash area, located south of

Building FC-816, flows into a stormwater sewer and then into a drainage ditch adjacent to H. M. Smith Boulevard.

A concrete-lined and bermed material storage area is also located on the southern portion of the site, to the north of Building FC-816. This bermed area is used for the temporary storage of vehicle maintenance fluids, spent or contaminated materials, fuel, and batteries. In addition, a number of storage lockers are located throughout the southern portion of the site. These lockers are used to store paints and other flammable materials used by maintenance and machine shop personnel.

The New River is located approximately one mile west of Site 1. A drainage ditch lies adjacent to the southern portion of the site along H. M. Smith Boulevard. The ditch flows west toward the HPIA Sewage Treatment Plant (i.e., Site 28) and empties into Cogdels Creek, which discharges into the New River. The majority of the site is situated on a topographic high with surface drainage predominantly to the west.

Site 1 has been used by several different mechanized, armored, and artillery units since the 1940s. Liquid wastes generated from the maintenance of mechanized vehicles were routinely poured onto the ground surface. These wastes have been reported to be primarily petroleum, oil, and lubricants (POL). In addition, battery acid is also noted to have been disposed at this site. The total extent of the suspected disposal area is estimated to be between seven and eight acres.

Acid from dead batteries is reported to have been hand carried from maintenance buildings to a disposal point. At times, holes were dug for waste acid disposal and immediately backfilled. During motor oil changes, vehicles were driven to a disposal point and drained of used oil. The suspected POL and acid disposal areas were not necessarily comparable. Quantities of these wastes have been estimated to be between 5,000 and 20,000 gallons of POL waste and between 1,000 and 10,000 gallons of battery acid waste. The site continues to serve as a vehicle and equipment maintenance/staging area (Water and Air Research, 1983).

Site 28

Site 28, the Hadnot Point Burn Dump, is located along the eastern bank of the New River. The site is within the Hadnot Point development area, approximately one mile south of HPIA on the Mainside portion of MCB, Camp Lejeune. Cogdels Creek flows into the New River at Site 28 and forms a natural divide between the eastern and western portions of the site. A majority of the estimated 23 acres that constitute the site are used for recreation and physical training exercises.

The Hadnot Point development area, which includes Site 28, has evolved over a 40-year period to encompass approximately 1,080 acres of land. Recreational land is scattered throughout the area, such as Site 28, and comprises nearly 18 percent or 196 acres of the Hadnot Point development area. Administrative buildings are principally situated to the west of Holcomb Boulevard, the main access route to the development area. Troop housing units are located in the western portion of Hadnot Point, toward the New River. Consolidated in the northern portion of Hadnot Point, the HPIA, and segregated from administrative buildings and housing units are supply, storage, and maintenance facilities. Administrative and support facilities together account for approximately 29 percent or 310 acres of Hadnot Point land area. Commercial uses, open spaces, and wooded areas constitute the remaining acreage in the Hadnot Point development area (Master Plan, 1988).

The Hadnot Point Sewage Treatment Plant (STP) is located adjacent to Site 28. The facility extends across Cogdels Creek via two 30-inch diameter aqueducts. The STP operates a number of clarifying, settling, and aeration ponds that are located on either side of Cogdels Creek. Both operational areas of the STP are fenced with six-foot chain link. The treated water from the STP discharges into the New River via an outfall pipeline approximately 400 feet from the shoreline.

Vehicle access to the site is via Julian C. Smith Boulevard near its intersection with O Street. The site is bordered to the north by the Hadnot Point STP, to the east and south by wooded areas, and to the west by the New River. Site 28 is predominantly comprised of two lawn and recreation areas, known collectively as the Orde Pond Recreation Area, that are separated by Cogdels Creek. The eastern and western portions of the site are served by an improved gravel road. Picnic pavilions, playground equipment, and the stocked fish pond, Orde Pond, which are located at the site are regularly used by base personnel and their families. In addition, field exercises and physical training activities frequently take place at the recreation area.

Site 28 operated from 1946 to 1971 as a burn area for a variety of solid wastes generated on base. Industrial and municipal wastes, oil-based paint, and construction debris were reportedly burned and subsequently covered with soil. In 1971 the burn dump ceased operations and the area was graded and seeded with grass. The total volume of fill is estimated to be between 185,000 and 375,000 cubic yards. The estimated volume of waste was based upon a surface area of 23 acres and a depth ranging from five to ten feet (Water and Air Research, 1983).

Site 30

Site 30, the Sneads Ferry Road Fuel Tank Sludge Area, is located along a tank trail that intersects Sneads Ferry Road from the west, approximately 1-1/6 miles south of the intersection with Marines Road and roughly 4-1/2 miles south of HPIA. The site is located adjacent to the Combat Town Training Area. The surrounding training areas and adjacent artillery ranges are used to prepare specialized personnel for various tactical operations and to simulate amphibious assault conditions.

Much of the suspected disposal area is wooded with trees of less than three inches in diameter and dense understory. No visual signs of contamination (e.g. soil staining) or other evidence is present at Site 30 that would suggest where disposal activities occurred. The tank trail that leads to the suspected disposal area is occasionally used as part of field training exercises. The site itself lacks security or protective measures that prevent personnel from entering the area. Unimproved paths both surround and are found within the suspected disposal area of Site 30. One of two streams which comprise the headwaters of Frenchs Creek lies approximately 1,500 feet west of the site. Surface water runoff and groundwater flow direction is generally to the west and north toward Frenchs Creek.

Sludge from fuel tanks, used to store leaded gasoline that contained tetraethyl lead and related compounds and wastewater from the washout of these tanks was disposed at this site by a private contractor. It is estimated that, at a minimum, 600 gallons of sludge were removed from tanks and drained onto the ground surface during the cleaning process. This estimate is based on the projected volume of material remaining in two 12,000 gallon tanks and the amount of material below their outflow ports. An additional amount of washout water also is likely to have been disposed. Supplemental information suggests that the site was used for the disposal of similar wastes from other tanks. The composition of the waste is unknown but may contain tetraethyl lead and cleansing compounds (Water and Air Research, 1983).

REMEDIAL INVESTIGATION ACTIVITIES

The field program was conducted at OU No. 7 from late March through early May 1994. A supplemental, round two groundwater sampling event was also performed in November of 1994 at all three sites. The RI focused on various areas of concern within OU No. 7 including: the northern and southern portions of Site 1; the western and eastern portions of Site 28; the New River, Cogdels Creek, and Orde Pond; Site 30; and Frenchs Creek. The following summarizes the investigations conducted and the number of environmental samples (excluding background and quality assurance/quality control [QA/QC] samples) collected at each site:

- Site 1
 - ▶ Soil Investigation (128 samples)
 - ▶ Groundwater Investigation (19 samples; 2 rounds of samples)

- Site 28
 - ▶ Soil Investigation (94 samples)
 - ▶ Groundwater Investigation (13 samples; 2 rounds of samples)
 - ▶ Surface Water and Sediment Investigations (14 surface water and 27 sediment samples)
 - ▶ Benthic and Aquatic Investigations (6 benthic and 19 samples)

- Site 30
 - ▶ Soil Investigation (25 samples)
 - ▶ Groundwater Investigation (3 samples; 2 rounds of samples)
 - ▶ Surface Water and Sediment Investigations (3 surface water and 6 sediment samples)

Note that surface water and sediment investigations were proposed at Site 1 (Baker, 1993a) within a drainage ditch located along the southern portion of the study area. However, the proposed investigations were not conducted because there was no surface water in the drainage ditch during the field program.

The field investigations focused on site areas which reportedly have been impacted by previous disposal practices. The potential areas of concern were identified from record searches and interviews with personnel, review of historical aerial photographs, previous investigation data, and information obtained during the pre-investigation scoping. The sampling programs for each site and media were developed based on these findings. Furthermore, seven-day laboratory turnaround of soil and groundwater data from this RI was also utilized to determine additional sampling locations.

Samples collected during the RI were submitted for laboratory analysis to CEIMIC, Inc. and data validation was performed by Heartland Environmental Services, Inc. A majority of the samples (excluding general chemistry and engineering parameters) were analyzed by Contract Laboratory Program (CLP) methods using Level IV Data Quality Objectives (DQOs). Additionally, Chester Engineers, Inc. performed statistical and frequency-of-detection analyses on the laboratory data.

Data collected from each site were analyzed and interpreted to evaluate the extent of contamination for each media investigated. Risk assessments were conducted to evaluate potential site risks to human health and the environment. Field data regarding the physical characteristics (e.g., geologic

and hydrogeological conditions) of each site were also analyzed and interpreted to assist in evaluating contaminant movement.

PHYSICAL CHARACTERISTICS OF THE STUDY AREA

Surface Water Hydrology and Drainage Features

Site 1

In the immediate vicinity of Site 1, there are several surface water features influencing surface drainage. In the southern area of Site 1 a drainage ditch (originally targeted for surface water and sediment sampling) receives surface water runoff from southern portion of Site 1 and nearby parking lots. During the field investigation, the ditch was observed to be dry with ponded water in some areas. Within the northern area of Site 1, a retention pond receives surface water runoff from parking lots and the surrounding areas.

Site 28

Cogdels Creek, the New River, and Orde Pond serve as the main surface water bodies in the vicinity of Site 28. Of these, the New River and Cogdels Creek have the most influence on surface drainage in the area. Drainage within the central and eastern portions of the site is influenced by Cogdels Creek and drainage within the western portion of the site is influenced by the New River. Areas along the New River and Cogdels Creek, where elevations are below 10 feet msl, are within the 100-year flood plain.

Site 30

There are no major surface water features within Site 30. Frenchs Creek, located approximately 1,500 feet west, is the closest surface water body. The head waters of the creek are located southwest of Site 30, and surface water flow is toward the north in the direction of the New River. Based on surface water elevation data, Frenchs Creek appears to receive groundwater recharge from the Site 30 area.

Geology

Site 1

The soils encountered at Site 1 were generally uniform throughout the site in both the shallow and deep subsurface. Shallow soils consisted of mostly sands and silty-sands, with lenses of silt and clay. These soils represent the Quaternary age "undifferentiated" Formation that characterizes the surficial water table aquifer. Fill material, consisting of sand and gravel, is present within the upper one to two feet bgs.

Shallow sands underlying Site 1 are fine-grained with varied amounts of silt (5 to 15 percent) and clay (5 to 10 percent). Results of the standard penetration tests indicated that the sands have a relative density of loose to very dense. Based on the visual-manual method described in ASTM D-2488, the sands classify as SM (defined as silty-sand, sand-silt mixtures) according to Unified Soil Classification System (USCS).

Two deep soil borings, advanced to approximately 120 feet bgs, indicated generally uniform deep soil conditions. The top of the River Bend Formation, marked by mixtures of sand and limestone fragments, was encountered at approximately 25 to 27 feet bgs in one boring. Sand, sand-shell mixtures, and limestone fragments within a sandy-clay matrix are present at depths below 55 feet bgs. The top of the Castle Hayne aquifer was encountered at approximately 25 to 27 feet bgs. A thin sandy-clay lens was encountered at approximately 92 feet bgs. Although this sandy-clay is present, the soil visually appeared to have a high enough permeability to permit vertical groundwater movement into the deeper aquifer.

Site 28

Shallow soils (to 30 feet) underlying Site 28 consist of predominantly fill material, sand, and silty-sand, with minor amounts of silt and clay. The appearance of the soils encountered at Site 28 was generally consistent with soils described for Site 1 ("undifferentiated" Formation). Based on the USCS description methodology, the shallow soils at Site 28 classify as SM. A large quantity of fill material is present underlying the western portion of the site. Various amounts and types of debris were noted within the fill material. The debris encountered included oxidized metal, glass, bricks, wire, and wood. Moreover, most of the material appeared charred from the burning operations.

Underlying the "undifferentiated" formation is the River Bend Formation marked by a layer of sand and marl. The upper portion of the Castle Hayne aquifer lies within the River Bend Formation. A sandy-clay lense was encountered at approximately 92 to 94 feet bgs as described for Site 1. Although this sandy-clay lense is present, the soil visually appeared to have a high enough permeability to permit vertical groundwater movement into the deeper aquifer.

Site 30

Soils underlying Site 30 consist of sand and silty-sand, and classify as SM under the USCS. The sands are fine-grained with varied amounts of silt (5 to 15 percent). Based on the standard penetration tests, the relative density of the soils ranged from very loose to dense.

HYDROGEOLOGY

Site 1

The hydrogeologic setting was evaluated by installing a network of shallow and deep monitoring wells throughout northern and southern areas of Site 1. Staff gauges were also proposed in the drainage ditch located in the southern portion of the site; however, the ditch was dry throughout most of the investigation and only received surface water runoff.

Two rounds of groundwater level measurements were collected. The initial round of measurements (March 19, 1994) was collected prior to the investigation and, therefore, only included the existing wells. Groundwater elevations measured in shallow wells on May 9, 1994 varied from 5.36 to 12.00 feet above msl. In the existing monitoring wells where two rounds of measurements were collected (March 19 and May 9, 1994), the water levels declined between 0.69 and 1.80 feet. The decline in the water table appears to be the result of normal seasonal fluctuations. Groundwater elevations measured in the deep wells on May 9, 1994 varied from 6.47 to 7.65 feet above msl.

The horizontal groundwater gradient and flow direction for the surficial aquifer were evaluated from the May 9, 1994 elevation data. Based on the May 9 data, the average gradient across the site is 0.0027, indicating a relatively flat water table surface. Groundwater flow is to the west-northwest

in the direction of the New River. Moreover, groundwater flow velocity within the surficial aquifer is estimated at 2.9×10^{-2} feet/day (10 feet/year).

Site 28

The hydrogeologic setting was evaluated by installing a network of shallow and deep monitoring wells throughout eastern and western portions of Site 28 and installing staff gauges in Cogdels Creek and Orde Pond. Additionally, information on the hydraulic characteristics of the surficial aquifer near Site 28 was evaluated during a pump test conducted by Baker at a UST site located adjacent to the HPIA sewage treatment plant.

Two rounds of groundwater level measurements were collected. The initial round of measurements (March 19, 1994) was collected prior to the investigation and, therefore, only included the existing wells. Groundwater elevations measured in shallow wells on May 10, 1994 varied from 1.36 to 2.47 feet above msl. In the existing monitoring wells where two rounds of measurements were collected (March 19 and May 10, 1994), the water levels declined between 0.16 and 0.38 feet. The decline in the water table appears to be the result of normal seasonal fluctuations. Groundwater elevations measured in the deep wells on May 10, 1994 varied from 1.36 to 2.47 feet above msl. The sandy-clay present at the top of the Castle Hayne may account for the slightly different groundwater elevations between the surficial and deep aquifers.

The horizontal groundwater gradients and flow directions for the surficial and deep aquifers were evaluated from the May 10, 1994 elevation data. Based on the May 9 data, the estimated gradients for the surficial and deep aquifers are 0.004 and 0.0013, respectively. Groundwater within the surficial aquifer appears to be discharging into Cogdels Creek. Moreover, groundwater flow velocity within the surficial aquifer is estimated at 4.1×10^{-2} feet/day (15 feet/year). For the Castle Hayne aquifer, groundwater flow is to the west-southwest toward the New River.

Site 30

The hydrogeologic setting was evaluated by installing three shallow monitoring wells and by installing staff gauges in Frenchs Creek. Two rounds of groundwater and surface water level measurements were collected. The initial round of measurements (March 19, 1994) was collected prior to the investigation and, therefore, only included the existing wells. Groundwater elevations measured in the shallow wells on May 9, 1994 varied from 30.55 to 37.97 feet above msl. In the existing monitoring wells where two rounds of measurements were collected (March 19 and May 9, 1994), the water levels declined between 1.18 and 1.65 feet.

The horizontal groundwater gradient and flow direction for the surficial aquifer were evaluated from the May 9, 1994 elevation data. Based on the May 9 data, the estimated gradient for the surficial aquifer is 0.015, indicating a moderately steep water table surface. Groundwater flow within the surficial aquifer is to the west-northwest in the direction of the Frenchs Creek. Moreover, groundwater flow velocity within the surficial aquifer is estimated at 0.15 feet/day (56 feet/year).

Potable Water Supply Wells

Potable water supply wells within a one-mile radius of each site were identified. Based on information obtained from a USGS publication (Harned, et al., 1989) and interviews with Base personnel, four supply wells are located within a one-mile radius of Sites 1 and 30 (two at each site). Two of the four wells, however, are no longer in service according to Base personnel. No wells were identified near Site 28.

EXTENT OF CONTAMINATION

Site 1

This section presents a summary of analytical findings from field sampling activities conducted at Site 1, French Creek Liquids Disposal Area. Because of asphalt and gravel overburden material, surface soil samples were not retained for laboratory analysis at a majority of sampling stations. Table ES-1 provides a summary of site contamination for Site 1 and Table ES-2 provides a comparison of round one versus round two groundwater results.

Soils

The pesticides dieldrin, 4,4'-DDE, 4,4'-DDD, 4,4'-DDT, endrin aldehyde, alpha-chlordane, and gamma-chlordane appear to be the most prevalent contaminants within soils at Site 1. Each of the six pesticides was detected, at low concentrations, in at least 2 of the 124 soil samples. The pesticide 4,4'-DDT was the most prevalent, with 10 positive detections ranging from 1.6 J to 18 J $\mu\text{g}/\text{kg}$. The highest pesticide concentration was that of 4,4'-DDE at 120 $\mu\text{g}/\text{kg}$. In general, pesticide detections were concentrated in the northern portion of the study area, and in particular, among soil borings 1-N-SB22, 1-N-SB26, 1-N-SB34 1-N-SB35, 1-N-SB37, and 1-GW17. The positive detections are, for the most part, limited to soil samples collected from less than seven feet below ground surface.

Aroclor 1254 and 1260 were each detected once within the subsurface sample set. Aroclor 1254 was detected in a sample from a monitoring well test boring on the southern portion of the site, at a concentration of 18 J $\mu\text{g}/\text{kg}$. Aroclor 1260 was identified at a concentration, 1,300 $\mu\text{g}/\text{kg}$, in boring 1-N-SB35. This boring is located near the center of the northern disposal area.

Volatile organic compounds (VOCs) were not found in surface soils and were detected in only four subsurface samples scattered throughout the site. The VOC acetone was detected in one sample from the southern portion of the study area. Review of the data suggests that acetone may have been an artifact of decontamination. Trichloroethene and toluene were detected at very low concentrations in samples also from the northern central portion of the study area.

Semivolatile organic compounds (SVOCs) were not encountered in surface soils, but were detected in a number of subsurface samples. Most notable among the SVOCs detected, were three polynuclear aromatic hydrocarbon (PAH) compounds and di-n-butylphthalate. The positive detections of these compounds were located near the northern central portion of the site. The random distribution of bis-(2-ethylhexyl)phthalate (BEHP) suggests the occurrence of laboratory contamination, although it was detected in excess of ten times the maximum blank concentration of 120 $\mu\text{g}/\text{kg}$.

TABLE ES-1

**SUMMARY OF SITE CONTAMINATION
SITE 1, FRENCH CREEK LIQUIDS DISPOSAL AREA
REMEDIAL INVESTIGATION, CTO-0231
MCB, CAMP LEJEUNE, NORTH CAROLINA**

Media	Fraction	Detected Contaminants	Comparison Criteria		Site Contamination				
			ARAR	Base Background	Min.	Max.	Max. Location	Detection Frequency	Distribution
Surface Soil	Volatiles	ND	NA	NA				0/14	
	Semivolatiles	ND	NA	NA				0/14	
	Pesticides	Dieldrin	NA	NA	4.3 J	4.3 J	1-GW17	1/14	central northern
		4-4'-DDE	NA	NA	2.2 J	4.9	1-GW17	2/14	central northern & southern
		4-4'-DDT	NA	NA	7.0 J	12	1-GW12	3/14	scattered
		Endrin aldehyde	NA	NA	3.9 NJ	3.9 NJ	1-GW17DW	1/14	central northern
	PCBs	ND	NA	NA				0/14	
	Metals (1)	Antimony	NA	0.3 - 8.0	9.0 J	11.9	1-GW11	3/14	3 exceed BB, all near pond
		Arsenic	NA	0.2 - 1.8	0.57	2.0	1-N-SB29	6/14	1 exceeds BB, scattered
		Beryllium	NA	0.03 - 0.16	0.19	0.19	1-GW07	1/14	1 exceeds BB, southern
		Cadmium	NA	0.18 - 0.58	0.62	2.0	1-GW16	3/14	3 exceed BB, southern
		Chromium	NA	0.3 - 12.5	1.5	6.4	1-GW07	13/14	none exceed BB
		Copper	NA	0.5 - 87.2	1.6	4.9	1-GW16	6/14	none exceed BB
		Lead	NA	0.5 - 142.0	1.0	23.5	1-GW16	14/14	none exceed BB
		Nickel	NA	0.6 - 3.6	1.6	3	1-GW17	3/14	none exceed BB
Zinc	NA	0.3 - 28.3	3.5	26.9	1-GW08	9/14	none exceed BB		
Subsurface Soil	Volatiles	Acetone	NA	NA	490 J	490 J	1-S-SB07	1/110	southern
		Trichloroethene	NA	NA	3 J	3 J	1-N-SB32	1/110	west of Building FC-120
		1,1,1,2 - TCA	NA	NA	27	27	1-S-SB11	1/110	central southern
		Toluene	NA	NA	1 J	1 J	1-GW17DW	1/110	central northern
	Semivolatiles	4-Nitrophenol	NA	NA	930	930	1-S-SB01	1/110	along Main Service Road, southern
		Phenanthrene (PAH)	NA	NA	47 J	47 J	1-N-SB36	1/110	north of Building FC-120
		di-n-butylphthalate	NA	NA	74 J	74 J	1-N-SB33	1/110	north of Building FC-120
		Fluoranthene (PAH)	NA	NA	110 J	110 J	1-N-SB36	1/110	north of Building FC-120
		Pyrene (PAH)	NA	NA	86 J	86 J	1-N-SB36	1/110	north of Building FC-120
		BEHP	NA	NA	36 J	8,700	1-N-SB26	45/110	scattered

TABLE ES-1 (Continued)

SUMMARY OF SITE CONTAMINATION
 SITE 1, FRENCH CREEK LIQUIDS DISPOSAL AREA
 REMEDIAL INVESTIGATION, CTO-0231
 MCB, CAMP LEJEUNE, NORTH CAROLINA

Media	Fraction	Detected Contaminants	Comparison Criteria		Site Contamination				
			ARAR	Base Background	Min.	Max.	Max. Location	Detection Frequency	Distribution
Subsurface Soil (Continued)	Pesticides	Dieldrin	NA	NA	7.1 J	39 J	1-N-SB26	2/110	central northern
		4,4'-DDE	NA	NA	11	120	1-N-SB26	2/110	central northern
		Endosulfan II	NA	NA	55	55	1-N-SB35	1/110	north of Building FC-120
		4,4'-DDD	NA	NA	2.2 J	28 J	1-N-SB26	2/110	scattered, northern
		4,4'-DDT	NA	NA	1.6 J	18 J	1-N-SB35	7/110	central northern, 1 southern
		Endrin aldehyde	NA	NA	24 NJ	24 NJ	1-N-SB35	1/110	north of Building FC-120
		alpha-Chlordane	NA	NA	4.2 NJ	9.2 NJ	1-N-SB37	2/110	northern
		gamma-Chlordane	NA	NA	2.5 NJ	2.9 NJ	1-N-SB26	2/110	central northern
	PCBs	Aroclor 1254	NA	NA	18 J	18 J	1-GW16	1/110	central, southern portion
		Aroclor 1260	NA	NA	1,300	1,300	1-N-SB35	1/110	north of Building FC-120
	Metals (1)	Antimony	NA	0.4 - 6.9	6.1 J	7.8 J	1-N-SB36	7/110	6 exceed BB, scattered
		Arsenic	NA	0.03 - 1.50	0.6	5.6	1-GW16DW	58/110	21 exceed BB, scattered
		Cadmium	NA	0.17 - 1.20	0.62	1.1	1-S-SB13	5/110	none exceed BB
		Chromium	NA	0.7 - 10.5	1.5	17.5	1-GW10	109/110	6 exceed BB, scattered
		Copper	NA	0.5 - 6.6	1.1	5	1-N-SB26	42/110	none exceed BB
		Lead	NA	0.5 - 11.5	1.3	60.4 J	1-N-SB26	101/110	6 exceed BB, northern
		Mercury	NA	0.01 - 0.68	0.06	0.34	1-S-SB01	7/110	none exceed BB
		Nickel	NA	0.6 - 4.7	1.2	4.4	1-N-SB32	40/110	none exceed BB
		Selenium	NA	0.12 - 0.55	0.81	1.5 J	1-S-SB03	2/110	2 exceed BB, northern & southern
		Silver	NA	0.18 - 1.00	1 J	1 J	1-S-SB12	1/110	does not exceed BB
Zinc	NA	0.3 - 11.6	0.63 J	78.6 J	1-S-SB01	74/110	8 exceed BB, scattered		
Groundwater	Volatiles (2)	Vinyl Chloride	NCWQS - 0.015	NA	2	4 J	1-GW10	1/19	1 exceeds ARAR, northwest
		1,1-Dichloroethene	MCL - 7	NA	2 J	2 J	1-GW10	1/19	does not exceed ARAR
		1,2-Dichloroethene	MCL - 100	NA	1 J	21	1-GW10	2/19	do not exceed ARAR
		Trichloroethene	NCWQS - 2.8	NA	1 J	27	1-GW17	3/19	2 exceed ARAR
		Xylenes (total)	NCWQS - 530	NA	3	19	1-GW12	1/19	does not exceed ARAR

ES-11

TABLE ES-1 (Continued)

**SUMMARY OF SITE CONTAMINATION
SITE 1, FRENCH CREEK LIQUIDS DISPOSAL AREA
REMEDIAL INVESTIGATION, CTO-0231
MCB, CAMP LEJEUNE, NORTH CAROLINA**

Media	Fraction	Detected Contaminants	Comparison Criteria		Site Contamination				
			ARAR	Base Background	Min.	Max.	Max. Location	Detection Frequency	Distribution
Groundwater (continued)	Semivolatiles (2)	Phenol	NA	NA	6.1 J	6.1 J	1-GW17DW	1/19	central northern portion
		Diethylphthalate	NCWQS - 5,000	NA	1.3 J	1.3 J	1-GW17DW	1/19	does not exceed ARAR
	Pesticides	ND	MCL/NCWQS				0/6		
	PCBs	ND	NA	NA				0/6	
	Total Metals (3)	Iron	NCWQS - 300	882 - 55,300	263	29200 J	1-GW12	9/19	9 exceed ARAR, none exceed BB
		Manganese	NCWQS - 50	10 - 290	2.5	1,200	1-GW11	18/19	15 exceed ARAR, 9 exceed BB

- Notes:
- Concentrations are presented in µg/L for liquid and µg/Kg for solids (ppb), metal concentrations for soils and sediments are presented in mg/Kg (ppm).
 - (1) Metals in both surface and subsurface soils were compared to the range of base background positive detections for priority pollutant metals only (i.e., antimony, arsenic, beryllium, cadmium, chromium, copper, lead, mercury, nickel, selenium, silver, thallium, zinc).
 - (2) Additional groundwater samples were collected from wells which exhibited concentrations of volatile and semivolatile compounds during the initial round.
 - (3) Total metals in groundwater samples were compared to the range of positive detections in upgradient wells throughout MCB, Camp Lejeune.
- ARAR - Applicable or Relevant and Appropriate Requirements
 BB - Base background (refer to Appendix M)
 BEHP - bis(2-ethylhexyl)phthalate
 NA - Not applicable
 NCWQS - North Carolina Water Quality Standard
 ND - Not detected
 MCL - Federal Maximum Contaminant Level
 PAH - Polynuclear aromatic hydrocarbon
 TCA - Tetrachloroethane

TABLE ES-2

COMPARISON OF GROUNDWATER ANALYTICAL RESULTS
SITE 1, FRENCH CREEK LIQUIDS DISPOSAL AREA
REMEDIAL INVESTIGATION, CTO-0231
MCB, CAMP LEJEUNE, NORTH CAROLINA

Detected Contaminants	Round 1 Results				Round 2 Results			
	Min.	Max.	Freq.	Max. Location	Min.	Max.	Freq.	Max. Location
Volatiles								
Vinyl Chloride	2	2	1/19	1-GW10	4 J	4 J	1/4	1-GW10
1,1-Dichloroethene	ND	ND	0/19	NA	2 J	2 J	1/4	1-GW10
1,2-Dichloroethene	1 J	10	2/19	1-GW10	21	21	1/4	1-GW10
Trichloroethene	1	27	3/19	1-GW17	8 J	18	2/4	1-GW17
Xylenes (total)	3	3	1/19	1-GW12	19	19	1/4	1-GW12
Semivolatiles								
Phenol	6 J	6 J	1/19	1-GW17DW	ND	ND	0/1	NA
Diethylphthalate	1 J	1 J	1/19	1-GW17DW	ND	ND	0/1	NA
Total Metals								
Aluminum	347	457,000 J	18/19	1-GW12	416	1,510	6/18	1-GW12
Antimony	34.3	88.6 J	5/19	1-GW08	ND	ND	0/18	NA
Arsenic	8.6	330	16/19	1-GW10	8.9	15.2	5/18	1-GW10
Barium	8.3	2,470	19/19	1-GW10	7.9	76.6	18/18	1-GW17
Beryllium	1	99.1	12/19	1-GW10	ND	ND	0/18	NA
Cadmium	3.1	43.1	14/19	1-GW09	ND	ND	0/18	NA
Calcium	3,270	720,000	19/19	1-GW15	900	137,000	18/18	1-GW15
Chromium	59.8 J	800 J	16/19	1-GW12	ND	ND	0/18	NA
Cobalt	6.5 J	306	14/19	1-GW10	14.1	30	2/18	1-GW10
Copper	6	105	17/19	1-GW12	ND	ND	0/18	NA
Iron	479	417,000	19/19	1-GW09	263	29200 J	9/18	1-GW12
Lead	16.6	163	16/19	1-GW14	1.4	2.4	2/18	1-GW08
Magnesium	671	30,900	19/19	1-GW15	550	7,090	18/18	1-GW16
Manganese	9.6	2,250	18/19	1-GW11	2.5	1,200	14/18	1-GW10
Mercury	0.15	0.87	8/19	1-GW09	0.14	1.2	11/14	1-GW04
Nickel	10	866	17/19	1-GW10	ND	ND	0/18	NA
Potassium	983	21,600 J	19/19	1-GW14	305	5,180	18/18	1-GW17
Selenium	4.5	22.6	5/19	1-GW12	ND	ND	0/18	NA
Silver	7.7 J	19.9 J	4/19	1-GW09	ND	ND	0/18	NA
Sodium	3,520	13,800	19/19	1-GW12	1,410	19200 J	18/18	1-GW12
Thallium	4.7	4.7	1/19	1-GW14	ND	ND	0/18	NA
Vanadium	4.2	811 J	17/19	1-GW12	3.6	11.4	2/18	1-GW12
Zinc	9.2	2,410	17/19	1-GW10	ND	ND	0/18	NA

TABLE ES-2 (Continued)

COMPARISON OF GROUNDWATER ANALYTICAL RESULTS
 SITE 1, FRENCH CREEK LIQUIDS DISPOSAL AREA
 REMEDIAL INVESTIGATION, CTO-0231
 MCB, CAMP LEJEUNE, NORTH CAROLINA

Detected Contaminants	Round 1 Results				Round 2 Results			
	Min.	Max.	Freq.	Max. Location	Min.	Max.	Freq.	Max. Location
Dissolved Metals								
Aluminum	35.6 J	797 J	10/19	1-GW09	ND	ND	0/18	NA
Antimony	46.6 J	90.6 J	8/19	1-GW11	ND	ND	0/18	NA
Arsenic	4.4	4.7	2/19	1-GW01	3.9	13.4	4/18	1-GW10
Barium	7.4	54.8	13/19	1-GW14	5.6	79.8	18/18	1-GW17
Calcium	1,690	136,000	19/19	1-GW02	876	127,000	18/18	1-GW15
Cobalt	4.1	35	5/19	1-GW10	13.4	29.6	2/18	1-GW10
Copper	6.8	6.8	1/19	1-GW16	7.0	18.1	18/18	1-GW03
Iron	126 J	18,800	8/19	1-GW12	8220 J	24100 J	5/18	1-GW12
Lead	ND	ND	0/19	NA	3.0	3.0	1/18	1-GW11
Magnesium	422	8,990	19/19	1-GW16	587	7,440	18/18	1-GW16
Manganese	1.6	1,070	16/19	1-GW11	2.3 J	1,220	12/18	1-GW10
Mercury	ND	ND	0/19	NA	0.13 J	0.72	8/12	1-GW16DW
Nickel	8.6	20.8	4/19	1-GW10	15.1	15.1	1/18	1-GW10
Potassium	326 J	3,180 J	19/19	1-GW17	365	5,470	18/18	1-GW17
Silver	ND	ND	0/19	NA	4.2 J	4.2 J	1/10	1-GW12
Sodium	3,180	15,000	19/19	1-GW12	1,230	17400 J	18/18	1-GW12
Thallium	4.8	4.8	1/19	1-GW17	ND	ND	0/18	NA
Vanadium	ND	ND	0/19	NA	3.1	3.9	2/18	1-GW12
Zinc	3.9	19.5	11/19	1-GW12	ND	ND	0/18	NA

Notes: Groundwater concentrations are presented in µg/L (ppb)
 J - Estimated
 NA - Not applicable
 ND - Not detected

Based on a comparison of base-specific background levels, positive detections of inorganics at Site 1 do not appear to be the result of past disposal practices.

Groundwater

Inorganic elements were the most prevalent among potential contaminants in groundwater at Site 1 and were found distributed throughout the site. Concentrations of Target Analyte List (TAL) total metals were generally higher in shallow groundwater samples than in samples obtained from the deeper aquifer. Iron and manganese were detected at concentrations that exceeded the NCWQS drinking water standards in nine and fifteen samples, respectively, obtained during the second sampling round. Barium, calcium, magnesium, potassium, and sodium were detected in each of the 18 shallow and deep groundwater samples.

Positive detections of VOCs and SVOCs in groundwater were limited to the northern portion of the study area. In general, VOC analytical results from the first and second sampling events correlated. The volatile compound trichloroethene was detected in samples obtained from three of the shallow monitoring wells. The maximum trichloroethene concentration, 27 µg/L, was detected within the sample from monitoring well 1-GW17, located in the central northern portion of the study area. The volatile compounds 1,2-dichloroethene and 1,1-dichloroethene were observed at maximum concentrations of 21 and 2 J µg/L, respectively. The maximum 1,2-dichloroethene and 1,1-dichloroethene concentrations were detected in a sample obtained from well 1-GW10, located to the west of the suspected northern disposal area. Vinyl chloride was detected at an estimated concentration of 4 J µg/L, also from well 1-GW10. Xylenes were detected in a shallow groundwater sample from well 1-GW12, at a maximum concentration of 19 µg/L. The SVOCs phenol and diethylphthalate were detected during the first sampling round only in a sample from well 1-GW17DW, at concentrations of 6 J and 1 J µg/L, respectively.

Site 28

This section presents a summary of analytical findings from field sampling activities conducted at Site 28, Hadnot Point Burn Dump. Table ES-3 provides a summary of site contamination for Site 28 and Table ES-4 provides a comparison of round one and round two groundwater results.

Soils

Semivolatile compounds within soil samples at Site 28 appear to be the most directly linked, among organic compounds, to past disposal practices. Several SVOCs were identified in both surface and subsurface soil samples, primarily from the western disposal area. A majority of SVOCs detected in soil samples were PAH compounds, probably resulting from combustion of waste material or refuse. As depicted in Table ES-3, several of the semivolatile compounds were detected at concentrations greater than 1,000 µg/kg.

Inorganic elements were detected in both surface and subsurface soil samples from the western portion of the study area at concentrations greater than one order of magnitude above of base-specific background levels. In general, elevated metal concentrations were limited to soils obtained from the western portion of the study area. The metals copper, lead, manganese, and zinc were observed at maximum concentrations greater than two orders of magnitude above base-specific background levels. The same three metals had several positive detections in excess of the one order of magnitude level.

TABLE ES-3

SUMMARY OF SITE CONTAMINATION
 SITE 28, HADNOT POINT BURN DUMP
 REMEDIAL INVESTIGATION, CTO-0231
 MCB, CAMP LEJEUNE, NORTH CAROLINA

Media	Fraction	Detected Contaminants	Comparison Criteria		Site Contamination				
			ARAR	Base Background	Min.	Max.	Max. Location	Detection Frequency	Distribution
Surface Soil	Volatiles	1,1,1-Trichloethane	NA	NA	2 J	2 J	28-E-SB27	1/40	eastern, adjacent Orde Pond
	Semivolatiles	bis(2-Chloroethyl)ether	NA	NA	69 J	69 J	28-E-SB28	1/40	eastern
		Naphthalene (PAH)	NA	NA	69 J	69 J	28-GW01	1/40	western
		Acenaphthene (PAH)	NA	NA	49 J	83 J	28-GW01	2/40	western
		Dibenzofuran	NA	NA	70 J	70 J	28-GW01	1/40	western
		Fluorene (PAH)	NA	NA	56 J	88 J	28-GW01	2/40	western
		Pentachlorophenol	NA	NA	46 J	46 J	28-E-SB26	1/40	eastern
		Phenanthrene (PAH)	NA	NA	41 J	1,100	28-W-SB17	8/40	primarily western
		Anthracene (PAH)	NA	NA	120 J	240 J	28-W-SB17	3/40	western
		Carbazole	NA	NA	69 J	170 J	28-GW01	3/40	western
		di-n-Butylphthalate	NA	NA	58 J	70 J	28-GW01DW	2/40	1 eastern, 1 western
		Fluoranthene (PAH)	NA	NA	43 J	1,800	28-GW01	12/40	primarily western
		Pyrene (PAH)	NA	NA	51 J	2,100	28-GW01	11/40	primarily western
		Butyl benzyl phthalate	NA	NA	88 J	88 J	28-W-SB02	1/40	western
		B(A)anthracene (PAH)	NA	NA	56 J	1,300	28-GW01	7/40	primarily western
		Chrysene (PAH)	NA	NA	43 J	1,200	28-GW01	9/40	primarily western
		B(B)fluoranthene (PAH)	NA	NA	41 J	2,100	28-GW01	10/40	primarily western
		B(K)fluoranthene (PAH)	NA	NA	41 J	740	28-W-SB17	7/40	primarily western
		Benzo(A)pyrene (PAH)	NA	NA	58 J	1,600	28-GW01	8/40	primarily western
		I(1,2,3-cd)pyrene (PAH)	NA	NA	44 J	1,500	28-GW01	6/40	western
		D(a,h)anthracene (PAH)	NA	NA	120 J	120 J	28-GW01	1/40	western
B(g,h,i)perylene (PAH)	NA	NA	49 J	1,700	28-GW01	6/40	western		

TABLE ES-3 (Continued)

**SUMMARY OF SITE CONTAMINATION
SITE 28, HADNOT POINT BURN DUMP
REMEDIAL INVESTIGATION, CTO-0231
MCB, CAMP LEJEUNE, NORTH CAROLINA**

Media	Fraction	Detected Contaminants	Comparison Criteria		Site Contamination				
			ARAR	Base Background	Min.	Max.	Max. Location	Detection Frequency	Distribution
Surface Soil (Continued)	Pesticides	Heptachlor epoxide	NA	NA	8 J	43 J	28-E-SB31	3/40	2 eastern, 1 western
		Dieldrin	NA	NA	7.1 J	7.1 J	28-E-SB28	1/40	eastern
		4-4'-DDE	NA	NA	4.4 NJ	1,300	28-GW01	25/40	scattered
		Endrin	NA	NA	35 J	35 J	28-E-SB28	1/40	western
		4-4'-DDD	NA	NA	0.91 NJ	320 J	28-GW01	17/40	scattered
		Endosulfan Sulfate	NA	NA	41 J	41 J	28-GW01	1/40	western
		4-4'-DDT	NA	NA	2.7 J	1,400	28-E-SB33	20/40	scattered
		Endrin aldehyde	NA	NA	7.1 J	7.1 J	28-E-SB28	1/40	eastern
		alpha-Chlordane	NA	NA	1.9 NJ	160 NJ	28-E-SB31	15/40	scattered
		gamma-Chlordane	NA	NA	1.9 NJ	96 J	28-E-SB34	9/40	primarily eastern
	PCBs	Aroclor 1254	NA	NA	47 J	58 J	28-W-SB12	2/40	western
		Aroclor 1260	NA	NA	44	44	28-W-SB15	1/40	eastern
	Metals (1)	Antimony	NA	0.3 - 8.0	6.4 J	28 J	28-W-SB08	6/43	4 exceed BB, western
		Arsenic	NA	0.2 - 1.8	0.56 J	16	28-W-SB08	25/43	7 exceed BB, primarily western
		Cadmium	NA	0.18 - 0.58	0.66	12.5	28-W-SB08	13/43	13 exceed BB, primarily western
		Chromium	NA	0.3 - 12.5	1.4 J	26	28-W-SB18	42/43	8 exceed BB, primarily western
		Copper	NA	0.5 - 87.2	1.5	4,260 J	28-W-SB11	42/43	7 exceed BB, western
		Lead	NA	0.5 - 142.0	3.9	551	28-W-SB18	43/43	6 exceed BB, western
		Mercury	NA	0.01 - 0.08	0.05	1.1	28-E-SB34	28/43	22 exceed BB, scattered
		Nickel	NA	0.6 - 3.6	1.1 J	36	28-GW01	25/43	11 exceed BB, primarily western
Selenium		NA	0.27 - 0.94	1.5	10 J	28-W-SB08	2/43	2 exceed BB, eastern & western	
Silver		NA	0.04 - 4.30	1.5 J	6 J	28-E-SB34	7/43	1 exceeds BB, eastern	
Thallium	NA	0.11 - 0.56	0.8	2.5	28-W-SB19	3/43	3 exceed BB, eastern & western		
Zinc	NA	0.3 - 28.3	6.7 J	23,100	28-W-SB08	41/43	24 exceed BB, higher detects west		

TABLE ES-3 (Continued)

SUMMARY OF SITE CONTAMINATION
 SITE 28, HADNOT POINT BURN DUMP
 REMEDIAL INVESTIGATION, CTO-0231
 MCB, CAMP LEJEUNE, NORTH CAROLINA

Media	Fraction	Detected Contaminants	Comparison Criteria		Site Contamination				
			ARAR	Base Background	Min.	Max.	Max. Location	Detection Frequency	Distribution
Subsurface Soil	Volatiles	Benzene	NA	NA	2 J	2 J	28-GW01DW	1/32	western
		Tetrachlorethene	NA	NA	5 J	5 J	28-W-SB11	1/32	western
	Semivolatiles	1,4-Dichlorobenzene	NA	NA	44 J	140 J	28-W-SB12	2/32	western
		4-Methylphenol	NA	NA	250 J	250 J	28-W-SB10	1/32	western
		Naphthalene (PAH)	NA	NA	39 J	2,600	28-W-SB10	6/32	western
		2-Methylnaphthalene	NA	NA	82 J	89 J	28-W-SB10	2/32	western
		Dimethyl phthalate	NA	NA	79 J	220 J	28-W-SB10	2/32	western
		Acenaphthene (PAH)	NA	NA	510	2,500 J	28-W-SB11	2/32	western
		Dibenzofuran	NA	NA	220 J	1,300 J	28-W-SB11	2/32	western
		Diethylphthalate	NA	NA	100 J	100 J	28-W-SB12	1/32	western
		Fluorene (PAH)	NA	NA	78 J	2,600 J	28-W-SB11	4/32	western
		Phenanthrene (PAH)	NA	NA	38 J	27,000	28-W-SB11	9/32	western
		Anthracene (PAH)	NA	NA	330 J	8,600	28-W-SB11	2/32	western
		Carbazole	NA	NA	94 J	4,700	28-W-SB11	2/32	western
		Fluoranthene (PAH)	NA	NA	40 J	2,700	28-GW01	9/32	primarily western
		Pyrene (PAH)	NA	NA	51 J	2,600	28-GW01	6/32	western
		B(a)anthracene (PAH)	NA	NA	120 J	24,000	28-W-SB11	3/32	western
		Chrysene (PAH)	NA	NA	46 J	22,000	28-W-SB11	5/32	western
		BEHP	NA	NA	62 J	1,300	28-W-SB10	15/32	scattered, western
		B(b)fluoranthene (PAH)	NA	NA	38 J	21,000	28-W-SB11	6/32	western
		B(k)fluoranthene (PAH)	NA	NA	50 J	18,000	28-W-SB11	3/32	western
		Benzo(a)pyrene (PAH)	NA	NA	43 J	21,000	28-W-SB11	4/32	western
		I(1,2,3-cd)pyrene (PAH)	NA	NA	100 J	11,000	28-W-SB11	3/32	western
		D(a,h)anthracene (PAH)	NA	NA	110 J	2,800 J	28-W-SB11	2/32	western
		B(g,h,i)perylene (PAH)	NA	NA	50 J	10,000	28-W-SB11	4/32	western

ES-18

TABLE ES-3 (Continued)

SUMMARY OF SITE CONTAMINATION
 SITE 28, HADNOT POINT BURN DUMP
 REMEDIAL INVESTIGATION, CTO-0231
 MCB, CAMP LEJEUNE, NORTH CAROLINA

Media	Fraction	Detected Contaminants	Comparison Criteria		Site Contamination				
			ARAR	Base Background	Min.	Max.	Max. Location	Detection Frequency	Distribution
Subsurface Soil (Continued)	Pesticides	4,4'-DDE	NA	NA	3.1 J	1,600	28-W-SB07	19/32	scattered
		4,4'-DDD	NA	NA	6.2	880 NJ	28-GW01DW	17/32	scattered
		4,4'-DDT	NA	NA	3 J	7,300	28-GW01DW	13/32	scattered
		alpha-Chlordane	NA	NA	2.7 J	65 J	28-W-SB12	3/32	western
		gamma-Chlordane	NA	NA	2.6 NJ	11 NJ	28-W-SB12	3/32	western
	PCBs	Aroclor 1242	NA	NA	140 J	140 J	28-GW07	1/32	western
		Aroclor 1260	NA	NA	25 J	77	28-W-SB03	2/32	western
	Metals (1)	Antimony	NA	0.4 - 6.9	5.9 J	46.7 J	28-W-SB09	16/51	15 exceed BB, western
		Arsenic	NA	0.03 - 1.50	0.69	25.1	28-W-SB06	41/51	30 exceed BB, scattered
		Beryllium	NA	0.03 - 2.30	0.24	1.1	28-W-SB13	4/51	none exceed BB
		Cadmium	NA	0.17 - 1.20	0.77	15.6	28-W-SB18	22/51	22 exceed BB, scattered
		Chromium	NA	0.7 - 10.5	2 J	128	28-W-SB18	50/51	27 exceed BB, primarily western
		Copper	NA	0.5 - 6.6	1.0 J	3,280	28-W-SB09	43/51	23 exceed BB, western
		Lead	NA	0.5 - 11.5	1.9 J	2,060 J	28-W-SB10	49/51	25 exceed BB, primarily western
		Mercury	NA	0.01 - 0.68	0.05	2.8	28-GW01	15/51	3 exceed BB, western
		Nickel	NA	0.6 - 4.7	1.6	102 J	28-W-SB06	23/51	14 exceed BB, western
		Selenium	NA	0.12 - 0.55	6 J	6 J	28-W-SB13	1/51	1 exceeds BB, western
		Silver	NA	0.18 - 1.00	1.1 J	18.4 J	28-W-SB12	13/51	13 exceed BB, scattered
		Thallium	NA	0.12 - 0.50	1	1	28-W-SB17	1/51	1 exceeds BB, western
Zinc	NA	0.3 - 11.6	0.95 J	4,330 J	28-W-SB08	43/51	24 exceed BB, primarily western		

ES-19

TABLE ES-3 (Continued)

SUMMARY OF SITE CONTAMINATION
 SITE 28, HADNOT POINT BURN DUMP
 REMEDIAL INVESTIGATION, CTO-0231
 MCB, CAMP LEJEUNE, NORTH CAROLINA

Media	Fraction	Detected Contaminants	Comparison Criteria		Site Contamination				
			ARAR	Base Background	Min.	Max.	Max. Location	Detection Frequency	Distribution
Groundwater	Volatiles	Chloroform	MCL - 0.1	NA	2	2	28-TGWPA	1/13	1 exceeds ARAR, central western
		Ethylbenzene	NCWQS -29	NA	5	5	28-TGWPA	1/13	does not exceed ARAR
		Xylenes (total)	NCWQS - 530	NA	19	19	28-TGWPA	1/13	does not exceed ARAR
	Semivolatiles	2-Methylphenol	NA	NA	1.3 J	1.3 J	28-GW07	1/13	western
		4-Methylphenol	NA	NA	29	29	28-GW07	1/13	western
		2,4-Dimethylphenol	NA	NA	2.2 J	4.0 J	28-TGWPA	2/13	central western
		2,4-Dichlorophenol	NA	NA	1.6 J	1.6 J	28-TGWPA	1/13	central western
		Naphthalene	NCWQS - 21	NA	99	99	28-TGWPA	1/13	1 exceeds ARAR, central western
		2-Methylnaphthalene	NA	NA	33	33	28-TGWPA	1/13	central western
		Dimethylphthalate	NA	NA	1 J	1 J	28-GW01	1/3	central western
		Acenaphthene (PAH)	NA	NA	1.3 J	31	28-TGWPA	2/13	central western
		Dibenzofuran	NA	NA	12	12	28-TGWPA	1/13	central western
		Fluorene (PAH)	NCWQS - 280	NA	18	18	28-TGWPA	1/13	does not exceed ARAR
		Phenanthrene (PAH)	NCWQS - 210	NA	14	14	28-TGWPA	1/13	does not exceed ARAR
		Anthracene (PAH)	NA	NA	2.6 J	2.6 J	28-TGWPA	1/13	central western
		Carbazole	NA	NA	11	11	28-TGWPA	1/13	central western
		di-n-Butylphthalate	NA	NA	1 J	1 J	28-GW06	1/13	western
		Fluoranthene (PAH)	NA	NA	1.7 J	1.7 J	28-TGWPA	1/13	central western
		Pyrene (PAH)	NA	NA	1 J	1 J	28-TGWPA	1/13	central western
		Pesticides (2)	4,4'-DDE	NA	NA	0.06 J	6.6 J	28-TGWPA	5/13
	4,4'-DDD		NA	NA	0.06 J	9	28-GW07	6/13	western
	4,4'-DDT		NA	NA	0.05 J	0.37 J	28-TGWPA	2/13	western
	gamma-Chlordane		NCWQS - 0.027	NA	0.05 J	0.05 J	28-GW08	1/13	does not exceed ARAR, western
	PCBs	ND	NA	NA				0/13	
	Total Metals (3)	Iron	NCWQS - 300	882 -55,300	147 J	40,600	28-GW07	11/12	7 exceed ARAR, none exceed BB
		Lead	NCWQS - 15	3.0 - 78.8	8.2	126	28-GW08	2/12	1 exceeds ARAR and BB
Manganese		NCWQS - 50	10 - 290	16.9	1,450	28-GW08	11/12	7 exceed ARAR, 1 exceeds BB	

ES-20

TABLE ES-3 (Continued)

SUMMARY OF SITE CONTAMINATION
 SITE 28, HADNOT POINT BURN DUMP
 REMEDIAL INVESTIGATION, CTO-0231
 MCB, CAMP LEJEUNE, NORTH CAROLINA

Media	Fraction	Detected Contaminants	Comparison Criteria		Site Contamination				
			ARAR	Base Background	Min.	Max.	Max. Location	Detection Frequency	Distribution
Orde Pond Surface Water	Volatiles	ND	NOAA/NCWQS	NA				0/2	
	Semivolatiles	ND	NOAA/NCWQS	NA				0/2	
	Pesticides	ND	NOAA/NCWQS	NA				0/2	
	PCBs	ND	NOAA	NA				0/2	
	Metals (3)	Thallium	NOAA - 4.0	ND	4.7	4.7	28-OP-SW02	1/2	1 exceeds ARAR and BB
Cogdels Creek Surface Water	Volatiles	ND	NOAA/NCWQS	NA				0/7	
	Semivolatiles	ND	NOAA/NCWQS	NA				0/7	
	Pesticides	ND	NOAA/NCWQS	NA				0/7	
	PCBs	ND	NOAA	NA				0/7	
	Metals (3)	Lead	NOAA - 1.32	1.2 - 10.4	1.9	4.2	28-CC-SW06	7/7	7 exceed ARAR, none exceed BB
New River Surface Water	Volatiles	ND	NOAA/NCWQS	NA				0/5	
	Semivolatiles	Phenanthrene (PAH)	NA	NA	1.4 J	1.4 J	28-NR-SW02	1/5	adjacent to study area
	Pesticides	4,4'-DDE	NOAA - 10.5	NA	0.04 J	0.04 J	28-NR-SW03	1/5	does not exceed ARAR
		4,4'-DDD	NOAA - 0.0064	NA	0.05 J	0.05 J	28-NR-SW03	1/5	1 exceeds ARAR
	PCBs	ND	NOAA	NA				0/5	
	Metals (3)	Copper	NOAA - 6.5	4 - 129	6.6	18.1	28-NR-SW01	3/5	3 exceed ARAR, none exceed BB
		Lead	NOAA - 1.32	1.2 - 10.4	1.7	23.4	28-NR-SW01	3/5	3 exceed ARAR, 1 exceeds BB
		Thallium	NOAA - 4	ND	5.6 J	5.6 J	28-NR-SW04	1/5	1 exceeds ARAR and BB
Zinc	NOAA - 58.9	18 - 111	10.4	363	28-NR-SW03	3/5	1 exceeds ARAR and BB		
Orde Pond Sediment	Volatiles	ND	NA	NA				0/4	
	Semivolatiles	ND	NOAA	NA				0/3	
	Pesticides	4,4'-DDD	NOAA - 2	NA	8.3 J	8.3 J	28-OP-SD01	1/3	1 exceeds ARAR
	PCBs	ND	NOAA	NA				0/3	
	Metals (3)	ND	NOAA	BB				0/3	

TABLE ES-3 (Continued)

**SUMMARY OF SITE CONTAMINATION
SITE 28, HADNOT POINT BURN DUMP
REMEDIAL INVESTIGATION, CTO-0231
MCB, CAMP LEJEUNE, NORTH CAROLINA**

Media	Fraction	Detected Contaminants	Comparison Criteria		Site Contamination				
			ARAR	Base Background	Min.	Max.	Max. Location	Detection Frequency	Distribution
Cogdels Creek Sediment	Volatiles	Carbon disulfide	NA	NA	9 J	13 J	28-CC-SD07	2/14	maximum upstream of site
	Semivolatiles	Phenanthrene (PAH)	NOAA - 225	NA	260 J	260 J	28-CC-SD03	1/14	1 exceeds ARAR, adjacent to site
		Anthracene (PAH)	NOAA - 85	NA	61 J	61 J	28-CC-SD03	1/14	does not exceed ARAR, adjacent
		Fluoranthene (PAH)	NOAA - 600	NA	77 J	340 J	28-CC-SD03	3/14	none exceed ARAR, adjacent
		Pyrene (PAH)	NOAA - 350	NA	63 J	250 J	28-CC-SD03	5/14	none exceed ARAR, scattered
		Butyl benzyl phthalate	NA	NA	410 J	410 J	28-CC-SD02	1/14	adjacent to site
		3,3'-Dichlorobenzidine	NA	NA	410 J	410 J	28-CC-SD02	1/14	adjacent to site
		B(a)anthracene (PAH)	NOAA - 230	NA	56 J	140 J	28-CC-SD03	2/14	niether exceed ARAR, adjacent
		Chrysene (PAH)	NOAA - 400	NA	58 J	160 J	28-CC-SD03	2/14	niether exceed ARAR, adjacent
		BEHP	NA	NA	100 J	1,700 J	28-CC-SD06	12/14	scattered up and downstream
		B(b)fluoranthene (PAH)	NA	NA	63 J	63 J	28-CC-SD02	1/14	adjacent to site
		B(k)fluoranthene (PAH)	NA	NA	42 J	42 J	28-CC-SD02	1/14	adjacent to site
		Benzo(a)pyrene (PAH)	NOAA - 400	NA	47 J	1,700 J	28-CC-SD05	9/14	5 exceed ARAR, all upstream
	Pesticides	4,4'-DDE	NOAA - 2	NA	6.4 J	200 J	28-CC-SD01	9/14	9 exceed ARAR, scattered
		4,4'-DDD	NOAA - 2	NA	4.3 J	450 J	28-CC-SD01	7/14	7 exceed ARAR, scattered
		4,4'-DDT	NOAA - 1	NA	50 J	50 J	28-CC-SD07	1/14	1 exceeds ARAR, upstream of site
		alpha-Chlordane	NOAA - 0.5	NA	2.6 NJ	5.9 NJ	28-CC-SD06	2/14	2 exceed ARAR, upstream of site
		gamma-Chlordane	NOAA - 0.5	NA	6.1 J	8.4 J	28-CC-SD07	2/14	2 exceed ARAR, upstream of site
	PCBs	ND	NOAA	NA				0/14	
	Metals (3)	Lead	NOAA - 35	1 - 314	6.8	202	28-CC-SD04	14/14	7 exceed ARAR, none exceed BB
		Mercury	NOAA - 0.15	ND	0.12	0.41	28-CC-SD01	6/14	4 exceed ARAR, 6 exceed BB
		Silver	NOAA - 1	7.3	2 J	2 J	28-CC-SD04	1/14	1 exceeds ARAR, downstream
		Zinc	NOAA - 120	12 - 926	9.3 J	303	28-CC-SD04	14/14	2 exceed ARAR, none exceed BB

TABLE ES-3 (Continued)

SUMMARY OF SITE CONTAMINATION
 SITE 28, HADNOT POINT BURN DUMP
 REMEDIAL INVESTIGATION, CTO-0231
 MCB, CAMP LEJEUNE, NORTH CAROLINA

Media	Fraction	Detected Contaminants	Comparison Criteria		Site Contamination				
			ARAR	Base Background	Min.	Max.	Max. Location	Detection Frequency	Distribution
New River Sediment	Volatiles	Carbon disulfide	NA	NA	2 J	2 J	28-NR-SD04	1/10	adjacent to site
	Semivolatiles	Acenaphthene	NOAA - 150	NA	150 J	150 J	28-NR-SD01	1/10	does not exceed ARAR, upstream
		Dibenzofuran	NA	NA	60 J	60 J	28-NR-SD01	1/10	upstream of site
		Fluorene (PAH)	NOAA - 35	NA	120 J	120 J	28-NR-SD01	1/10	exceeds ARAR, upstream of site
		Phenanthrene (PAH)	NOAA - 225	NA	47 J	1,200	28-NR-SD01	4/10	2 exceed ARAR, max. upstream
		Anthracene (PAH)	NOAA - 85	NA	97 J	320 J	28-NR-SD01	4/10	2 exceed ARAR, max. upstream
		Carbazole	NA	NA	57 J	160 J	28-NR-SD01	3/10	maximum upstream of site
		Fluoranthene (PAH)	NOAA - 600	NA	80 J	1,600	28-NR-SD01	6/10	3 exceed ARAR, max. upstream
		Pyrene (PAH)	NOAA - 350	NA	75 J	1,700	28-NR-SD01	6/10	5 exceed ARAR, max. upstream
		B(a)anthracene (PAH)	NOAA - 230	NA	150 J	1,500	28-NR-SD05	5/10	4 exceed ARAR, max. downstream
		Chrysene (PAH)	NOAA - 400	NA	160 J	2,100	28-NR-SD05	5/10	3 exceed ARAR, max. downstream
		BEHP	NA	NA	580	2,400	28-NR-SD04	3/10	scattered up and downstream
		B(b)fluoranthene (PAH)	NA	NA	55 J	1,100	28-NR-SD01	6/10	maximum upstream of site
		B(k)fluoranthene (PAH)	NA	NA	120 J	840	28-NR-SD05	5/10	maximum downstream of site
		Benzo(a)pyrene (PAH)	NOAA - 400	NA	130 J	710	28-NR-SD01	5/10	3 exceed ARAR, max. upstream
		I(1,2,3-cd)pyrene (PAH)	NA	NA	68 J	320 J	28-NR-SD01	6/10	maximum upstream of site
		D(a,h)anthracene (PAH)	NOAA - 60	NA	47 J	47 J	28-NR-SD03	1/10	does not exceed ARAR, adjacent
		B(g,h,i)perylene (PAH)	NA	NA	65 J	320 J	28-NR-SD01	5/10	maximum upstream of site
		Pesticides	4,4'-DDE	NOAA - 2	NA	8.4	8.5	28-NR-SD01	2/10
	4,4'-DDD		NOAA - 2	NA	8.6	15	28-NR-SD01	3/10	3 exceed ARAR, max. upstream
	4,4'-DDT		NOAA - 1	NA	33	300	28-NR-SD03	3/10	3 exceed ARAR, max. adjacent
alpha-Chlordane	NOAA - 0.5		NA	4.8	6.6 J	28-NR-SD04	2/10	2 exceed ARAR, max. at Cogdels	
gamma-Chlordane	NOAA - 0.5		NA	3.1 J	4.6 J	28-NR-SD04	2/10	2 exceed ARAR, max. at Cogdels	

TABLE ES-3 (Continued)

SUMMARY OF SITE CONTAMINATION
 SITE 28, HADNOT POINT BURN DUMP
 REMEDIAL INVESTIGATION, CTO-0231
 MCB, CAMP LEJEUNE, NORTH CAROLINA

Media	Fraction	Detected Contaminants	Comparison Criteria		Site Contamination				
			ARAR	Base Background	Min.	Max.	Max. Location	Detection Frequency	Distribution
New River Sediment (Continued)	PCBs	ND	NOAA	NA				0/10	
	Metals (3)	Antimony	NOAA - 2	ND	8.7 J	263	28-NR-SD01	2/10	2 exceed ARAR, max. upstream
		Copper	NOAA - 70	0.43 - 53,200	1.5	1,340	28-NR-SD01	10/10	2 exceed ARAR, both upstream
		Lead	NOAA - 35	1 - 314	3.5 J	38,800	28-NR-SD01	10/10	2 exceed ARAR, both upstream
		Silver	NOAA - 1	7.3	3.1 J	3.4 J	28-NR-SD03	2/10	2 exceed ARAR, max. adjacent

- Notes:
- Concentrations are presented in $\mu\text{g/L}$ for liquid and $\mu\text{g/Kg}$ for solids (ppb), metal concentrations for soils and sediments are presented in mg/Kg (ppm).
 - (1) Metals in both surface and subsurface soils were compared to the range of base background positive detections for priority pollutant metals only (i.e., antimony, arsenic, beryllium, cadmium, chromium, copper, lead, mercury, nickel, selenium, silver, thallium, zinc).
 - (2) An additional round of groundwater samples were collected from wells which exhibited concentrations of pesticides during the first round.
 - (3) Total metals in groundwater, surface water, and sediment were compared to the range of positive detections in upgradient samples at MCB, Camp Lejeune.
- ARAR - Applicable or Relevant and Appropriate Requirements
 BB - Base background (refer to Appendix M)
 BEHP - bis(2-ethylhexyl)phthalate
 NA - Not applicable
 NCWQS - North Carolina Water Quality Standard
 ND - Not detected
 NOAA - National Oceanic and Atmospheric Administration
 MCL - Federal Maximum Contaminant Level
 PAH - Polynuclear aromatic hydrocarbon

TABLE ES-4

**COMPARISON OF GROUNDWATER ANALYTICAL RESULTS
SITE 28, HADNOT POINT BURN DUMP
REMEDIAL INVESTIGATION, CTO-0231
MCB, CAMP LEJEUNE, NORTH CAROLINA**

Detected Contaminants	Round 1 Results				Round 2 Results			
	Min.	Max.	Freq.	Max. Location	Min.	Max.	Freq.	Max. Location
Pesticides								
4,4'-DDE	0.06 J	6.6 J	5/13	28-TGWPA	ND	ND	0/5	NA
4,4'-DDD	0.06 J	9	6/13	28-GW07	ND	ND	0/5	NA
4,4'-DDT	0.05 J	0.37 J	2/13	28-TGWPA	ND	ND	0/5	NA
gamma-Chlordane	0.05 J	0.05 J	1/13	28-GW08	ND	ND	0/5	NA
Total Metals								
Aluminum	225	100,000 J	12/13	28-GW05	420	1,670	3/12	28-GW08
Antimony	42.7	5,340	4/13	28-GW07	ND	ND	0/12	NA
Arsenic	5.2	76.7	11/13	28-GW07	3.7	4.7	3/12	28-MW13
Barium	13.7	1,980	12/13	28-GW07	6.3	759	12/12	28-GW08
Beryllium	1.1	9.6	5/13	28-GW04	ND	ND	0/12	NA
Cadmium	3.2	35.4	10/13	28-GW07	ND	ND	0/12	NA
Calcium	16,100	245,000	12/13	28-MW13	2,890	183,000	12/12	28-GW07
Chromium	33.2 J	308 J	10/13	28-GW07	ND	ND	0/12	NA
Cobalt	4.1	30.4	6/13	28-GW07	ND	ND	0/12	NA
Copper	12.2	2,250	7/13	28-GW07	14.5	44	2/12	28-GW08
Iron	417	245,000	11/13	28-GW07	147 J	40,600	11/12	28-GW07
Lead	1.5	4,810	12/13	28-GW07	8.2	126	2/12	28-GW08
Magnesium	498	52,900	12/13	28-GW07	1,190	35,400	11/12	28-GW08
Manganese	29.6	3,330	11/13	28-GW07	16.9	1,450	11/12	28-GW08
Mercury	0.16 J	2 J	9/13	28-GW07	0.14 J	0.58 J	7/12	28-GW04
Nickel	10.4	165	9/13	28-GW07	13.5	13.5	1/12	28-GW07
Potassium	2,100	63,500	12/13	28-GW07	866	84,700	12/12	28-GW08
Selenium	5.6 J	5.6 J	1/13	28-GW07	ND	ND	0/12	NA
Silver	5.4 J	37.9 J	4/13	28-GW07	ND	ND	0/12	NA
Sodium	6,770	744,000	12/13	28-GW01DW	5,670	803,000	12/12	28-GW01DW
Thallium	6.9 J	6.9 J	1/13	28-GW01DW	ND	ND	0/12	NA
Vanadium	13.4	190 J	10/13	28-GW01	6.9	6.9	1/12	28-GW07DW
Zinc	23.1	9,220	10/13	28-GW07	331	331	1/12	28-GW08

TABLE ES-4 (Continued)

**COMPARISON OF GROUNDWATER ANALYTICAL RESULTS
SITE 28, HADNOT POINT BURN DUMP
REMEDIAL INVESTIGATION, CTO-0231
MCB, CAMP LEJEUNE, NORTH CAROLINA**

Detected Contaminants	Round 1 Results				Round 2 Results			
	Min.	Max.	Freq.	Max. Location	Min.	Max.	Freq.	Max. Location
Dissolved Metals								
Aluminum	33.4 J	706	7/13	28-TGWPA	19.6	105	4/12	28-GW06
Antimony	35.5 J	70.2	2/13	28-TGWPA	ND	ND	0/12	NA
Arsenic	3.1	7.8	5/13	28-TGWPA	2	5.6	8/12	28-GW07
Barium	21.5	423	11/13	28-GW02	6.4	606	12/12	28-GW08
Calcium	6,400	187,000	13/13	28-MW13	3,820	195,000	12/12	28-MW13
Chromium	7.5 J	7.5 J	1/13	28-MW13	ND	ND	0/12	NA
Cobalt	4.5	4.5	1/13	28-GW06	ND	ND	0/12	NA
Copper	11.3	11.3	1/13	28-GW09DW	5.3	17.1	12/12	28-GW08
Iron	57.8	30,200 J	7/13	28-GW05	10	32,600	11/12	28-GW07
Lead	1.8	1.8	1/13	28-GW06	6.9	6.9	1/12	28-GW09DW
Magnesium	455	41,200	12/13	28-GW07	1,360	34,400	11/12	28-GW08
Manganese	1.7 J	603	12/13	28-GW08	20	1,160	11/12	28-GW08
Nickel	7.1	9.5	3/13	28-GW02	ND	ND	0/12	NA
Potassium	1,070	61,700	12/13	28-GW07	969	89,100	12/12	28-GW08
Silver	7.8	7.8	1/13	28-GW03	ND	ND	0/12	NA
Sodium	7,280	778,000	13/13	28-GW01DW	7,180	785,000	12/12	28-GW01DW
Vanadium	4.2	4.2	1/13	28-GW07DW	6.0	6.0	1/12	28-GW07
Zinc	7.3	44.6	3/13	28-GW06	ND	ND	0/12	NA

Notes: Groundwater concentrations are presented in µg/L (ppb)

J - Estimated

NA - Not applicable

ND - Not detected

The pesticides dieldrin, 4,4'-DDE, 4,4'-DDD, 4,4'-DDT, alpha-chlordane, and gamma-chlordane appear to be the most widely scattered contaminants within soils at Site 28. Each of the five pesticides was detected in at least 15 of the 72 soil samples. The pesticide 4,4'-DDE was the most prevalent, with 44 positive detections ranging from 3.1 J to 1,600 µg/kg. The highest pesticide concentration was that of 4,4'-DDT at 7,300 µg/kg. In general, higher concentrations of those pesticides more frequently detected, were limited to the western portion of the study area, and in particular among borings 28-GW01, 28-GW01DW, and 28-W-SB12.

Three organic PCB contaminants, Aroclors 1242, 1254, and 1260, were detected in soil samples obtained from borings at Site 28. The maximum PCB concentration was 140 J µg/kg from the pilot test boring 28-GW07.

Volatile compounds were found in one surface soil sample and two subsurface samples at very low concentrations. The VOCs benzene, tetrachloroethene, and 1,1,1-trichloroethane were each detected once within the 72 soil samples collected at Site 28. Based upon their wide dispersion, infrequent detection, and low concentration, the occurrence of volatile compounds in soils at Site 28 does not appear to be the result of past disposal practices.

Groundwater

Inorganic elements were the most prevalent and widely distributed contaminants in groundwater at Site 28 and were found distributed throughout the site. Concentrations of TAL total metals, in samples obtained during both sampling rounds, were generally higher in shallow groundwater samples than in samples collected from the deeper aquifer. Lead was detected, and confirmed by the second sampling round, within only 1 of the 12 shallow and deep groundwater samples at a concentration which exceeded the NCWQS and federal action level. This sample was collected from 28-GW08. Lead was also detected during the first sampling round in a sample retained from temporary well 28-TGWPA at a concentration which exceeded the NCWQS and federal action level. Iron and manganese were the most prevalent inorganic elements detected during both sampling rounds. Concentrations of iron and manganese were confirmed by the second sampling round to have exceeded either federal or state standards within 7 groundwater samples.

Semivolatile compounds were detected in five of ten shallow groundwater samples obtained during the first sampling round from the western portion of the study area. The maximum SVOC concentration, 99 µg/L, was detected within the sample from temporary monitoring well 28-TGWPA, located in the central western portion of the study area. Semivolatile analyses of groundwater samples were not performed as part of the second sampling round.

The organic pesticide compounds 4,4'-DDE, 4,4'-DDD, 4,4'-DDT, and gamma-chlordane were each detected at least once within samples obtained from six shallow monitoring wells located on the western portion of Site 28, during the first sampling round. Pesticides 4,4'-DDE and 4,4'-DDD were detected within five and six shallow groundwater samples, respectively. The highest pesticide concentration detected was 9 µg/L, within the sample obtained from monitoring well 28-GW07. A second round of groundwater samples was obtained from those monitoring wells that presented evidence of pesticide contamination during the first sampling round. However, groundwater samples obtained during the second sampling round did not exhibit pesticides.

Positive detections of VOCs in groundwater were limited to the central western portion of the study area. The volatile compounds chloroform, ethylbenzene, and xylenes were detected in a single shallow groundwater sample obtained from temporary well 28-TGWPA.

Surface Water

Orde Pond

Fourteen of 23 TAL total metals were positively identified in the two surface water samples from Orde Pond. Thallium was the only metal identified at a concentration in excess of chronic screening values established by the National Oceanic and Atmospheric Administration (NOAA). The thallium concentration in sample 28-OP-SW02, obtained from the eastern end of Orde Pond, exceeded the NOAA chronic screening value of 4.0 µg/L by only 0.7 µg/L. No other total metal concentrations were in excess of chronic screening values.

Cogdels Creek

Laboratory analyses of the seven Cogdels Creek surface water samples indicate that 14 of 23 possible total metals were positively detected. Lead was the only metal identified at a concentration in excess of the NOAA chronic screening values. Lead was detected within each of the seven surface water samples in excess of the 1.32 µg/L screening value. The maximum concentration of lead, 4.2 µg/L, was observed in a sample collected upstream of the study area. None of the positive lead detections exceeded the maximum base-specific surface water background concentration of 10.4 µg/L. No other total metal concentrations in the seven surface water samples exceeded chronic screening values.

New River

A positive detection of one semivolatile organic compound was observed among the five New River surface water samples. The SVOC phenanthrene was detected at a trace concentration of 1 µg/L in sample 28-NR-SW02, located slightly upstream of the study area. The pesticide organic compounds 4,4'-DDE and 4-4'-DDD were detected in surface water sample 28-NR-SW03, located adjacent to the western disposal area, at estimated concentrations of 0.04 J and 0.05 J µg/L, respectively.

Sixteen of 23 TAL total metals were positively identified in the five surface water samples collected from the New River. Copper, lead, thallium, and zinc were each identified at concentrations in excess of NOAA chronic screening values. Thallium and zinc were detected in excess of surface water screening values in one sample each. Copper, and lead each exceeded screening values in a total of three surface water samples. The thallium concentration in sample 28-NR-SW04, located at the mouth of Cogdels Creek, exceeded the NOAA chronic screening value of 4.0 µg/L by 1.6 µg/L. Copper and lead were detected, among the five New River surface water samples, at maximum concentrations of 181 and 23.4 µg/L, respectively. Both maximum detections of copper and lead were observed in sample 28-NR-SW01, located approximately 100 yards upstream of the study area. The sample 28-NR-SW03, collected adjacent to the western disposal area, had copper, lead, and zinc concentrations of 6.6, 3.1, and 363 µg/L, respectively. Each of these three detections was in excess of the established chronic surface water screening values for copper, lead, and zinc of 6.5, 1.32, and 58.9 µg/L, respectively. No other total metal concentrations in the seven surface water samples exceeded chronic screening values.

Sediments

Orde Pond

Volatile and semivolatile organic compounds were not detected among the samples retained for analysis from Orde Pond. The pesticide 4,4'-DDD was detected at an estimated concentration of 8.3 J $\mu\text{g}/\text{kg}$ within sample 28-OP-SD01, located near the western bank of Orde Pond. The positive detection of 4,4'-DDD at this location is in excess of the NOAA Effects Range - Low (ER-L) screening criteria of 2 $\mu\text{g}/\text{kg}$. No total metal concentrations in any of the Orde Pond samples exceeded NOAA screening values.

Cogdels Creek

Carbon disulfide was the only volatile organic compound detected among the 14 Cogdels Creek sediment samples. The maximum detection of carbon disulfide, 13 J $\mu\text{g}/\text{kg}$, was identified within sample 28-CC-SD07, collected upstream of the study area. The other detection of carbon disulfide was from a sample located downstream of the site, near the mouth of Cogdels Creek.

A number of semivolatile organic compounds were identified within Cogdels Creek sediment samples. A total of 12 SVOCs were detected in the 14 Cogdels Creek samples. Nine of the 12 detected SVOCs were identified exclusively in samples 28-CC-SD03 and 28-CC-SD02, located adjacent to and downstream of the disposal area. The maximum semivolatile concentration, 1,700 $\mu\text{g}/\text{kg}$, was that of both BEHP and the PAH benzo(a)pyrene. Benzo(a)pyrene was positively detected within 9 of the 14 samples submitted for laboratory analysis. Five of those nine positive benzo(a)pyrene detections exceeded the NOAA screening value of 400 $\mu\text{g}/\text{kg}$, all within samples collected upstream of the study area. The phenanthrene concentration in sample 28-CC-SD03, located adjacent to the study area, exceeded the NOAA screening value of 225 $\mu\text{g}/\text{kg}$ by 35 $\mu\text{g}/\text{kg}$.

The organic pesticides 4,4'-DDE and 4,4'-DDD were detected within 9 and 7 of the 14 Cogdels Creek sediment samples, respectively. As indicted on Table 14-2, each of the detections found upstream and downstream of the study area were in excess of NOAA screening values. Both 4,4'-DDE and 4,4'-DDD were detected at their respective maximum concentrations at sample station 28-CC-SD01, located at the mouth of Cogdels Creek. The positive 4,4'-DDE and 4,4'-DDD detections of 200 J and 450 J $\mu\text{g}/\text{kg}$, respectively, exceeded the NOAA screening value for both pesticide contaminants of 2 $\mu\text{g}/\text{kg}$. The pesticides 4,4'-DDT, alpha-chlordane, and gamma-chlordane were also detected at concentrations which, in each case, exceeded screening values. The three pesticides were observed in only two samples retained from upstream locations. The estimated maximum concentrations of 4,4'-DDT, alpha-chlordane, and gamma-chlordane were 50 J, 5.9 NJ, and 8.4 J $\mu\text{g}/\text{kg}$, respectively.

Twenty-two of 23 TAL total metals were positively identified in the 14 sediment samples retained from Cogdels Creek (selenium was not detected). Lead, mercury, silver, and zinc were each identified at concentrations in excess of NOAA ER-L screening values. Silver and zinc were detected in excess of sediment screening values within one and two Cogdels Creek sediment samples, respectively. Lead and mercury exceeded screening values in 7 and 4 of the 14 Cogdels Creek sediment samples. The silver concentration of 2 mg/kg in sample 28-CC-SD04, located adjacent to the disposal area, exceeded the NOAA screening value for of 1.0 mg/kg. Lead and mercury were detected, among the 14 Cogdels Creek sediment samples, at maximum concentrations of 202 and 0.41 mg/kg, respectively. The maximum detection of lead was observed in sample 28-CC-SD04,

located adjacent to the study area. Mercury was observed at a maximum concentration at sample station 28-CC-SD01, located near the mouth of Cogdels Creek. No other total metal concentrations among the 14 Cogdels Creek sediment samples exceeded screening values.

New River

Carbon disulfide was the only volatile organic compound detected among the ten sediment samples collected from the New River. The only detection of carbon disulfide, 2 J $\mu\text{g}/\text{kg}$, was identified within sample 28-NR-SD02, located slightly upstream of the study area. No other volatile compounds were detected.

A number of semivolatile organic compounds were identified within sediment samples retained from the New River. A total of 17 SVOCs, 13 of which were PAHs, were detected in the 10 New River sediment samples. Twelve of the 17 positively detected SVOCs were identified at their respective maximum concentrations in sample 28-NR-SD01, located approximately 100 yards upstream of the study area. The maximum PAH concentration, 2,100 $\mu\text{g}/\text{kg}$, was that of chrysene. Chrysene was positively detected within five of the sediment samples submitted for laboratory analysis from the New River. Three of those five positive chrysene detections exceeded the NOAA screening value of 400 $\mu\text{g}/\text{kg}$. Phenanthrene, anthracene, fluoranthene, pyrene, benzo(a)anthracene, and benzo(a)pyrene were also detected within sediment samples in excess of sediment screening values. In general, concentrations of SVOCs in the two samples obtained adjacent to the western disposal area were lower than those detections observed both upstream and downstream of the study area.

The organic pesticides 4,4'-DDE, 4,4'-DDD, 4,4'-DDT, alpha-chlordane, and gamma-chlordane were each detected in either two or three of the ten New River sediment samples. Each of the detections was in excess of NOAA screening values. Both 4,4'-DDE and 4,4'-DDD were detected at their respective maximum concentrations at sample station 28-NR-SD01, located upstream of the study area. The positive 4,4'-DDE and 4,4'-DDD detections of 8.5 and 15 $\mu\text{g}/\text{kg}$, respectively, exceeded the NOAA screening value for both pesticide contaminants of 2 $\mu\text{g}/\text{kg}$. The pesticides 4,4'-DDT, alpha-chlordane, and gamma-chlordane were also detected at concentrations which, in each case, exceeded screening values. Alpha- and gamma-chlordane were observed in only two samples retained from the New River, located adjacent to and downstream of the site. The maximum concentrations of 4,4'-DDT, alpha-chlordane, and gamma-chlordane were 300, 6.6 J, and 4.6 J $\mu\text{g}/\text{kg}$, respectively.

Nineteen of 23 TAL total metals were positively identified in the 10 New River sediment samples (beryllium, cadmium, selenium, and thallium were not detected). Antimony, copper, lead, and silver were each identified at concentrations in excess of NOAA ER-L screening values. Each of the four metal contaminants were detected in excess of sediment screening values within two samples retained from the New River. Antimony, copper, and lead were each detected at their respective maximum concentrations among the ten New River samples at station 28-NR-SD01, located upstream of the study area. The copper concentration of 1,340 mg/kg in sample 28-NR-SD01 exceeded the NOAA screening value of 70 mg/kg . Antimony and lead were detected at maximum concentrations of 263 and 38,800 mg/kg , respectively. The NOAA screening values for antimony and lead are 2 and 35 mg/kg , respectively. Concentrations of silver in samples 28-NR-SD03, 3.4 J mg/kg , and 28-NR-SD05, 3.1 J mg/kg , slightly exceeded the NOAA value of 1 mg/kg . No other total metal concentrations among the ten New River sediment samples exceeded screening values.

Aquatic Organisms

Orde Pond

The pesticides 4,4'-DDE and alpha-chlordane were detected among the whole body tissue samples collected in Orde Pond. The maximum pesticide concentration was that of 4,4'-DDE at 38 µg/kg. Positive detections of VOCs and SVOCs in whole body tissue samples were rejected because of laboratory contamination. Total xylenes were detected in the American eel tissue sample at an estimated concentration of 8 J µg/kg.

Sixteen metals were detected in the whole body tissue samples collected from Orde Pond. The metals antimony, arsenic, chromium, copper, mercury, selenium, and zinc were found in Orde Pond biotia samples at maximum concentrations of 0.17 J, 0.10 J, 10.7 J, 1.2 J, 0.18 J, 0.45 J, and 26.3 J µg/kg, respectively.

The majority of volatile and semivolatile contaminant analyses from Orde Pond fillet samples were rejected because of laboratory interference. Therefore, the results of those analyses are inconclusive. There were no pesticides or PCBs detected in the fillet tissue samples, however.

Thirteen metals were detected in the fillet tissue samples collected from Orde Pond. The priority pollutant metals arsenic, chromium, copper, mercury, selenium, and zinc were detected in Orde Pond fillet samples at maximum concentrations of 0.1 J, 0.63 J, 0.22 J, 0.23 J, 0.32 J, and 22.9 µg/kg, respectively. The maximum tissue levels of metals in fillet tissue samples were found in the largemouth bass, blue gill, and redear sunfish.

New River

The pesticides beta BHC, 4,4'-DDE, 4,4'-DDD, endrin aldehyde, and alpha-chlordane were detected among the whole body tissue samples from stripped mullet, summer flounder, and Atlantic menhaden in the New River. Positive detections of VOCs and SVOCs were considered common laboratory contaminants.

Twenty of 23 TAL metals were detected in New River whole body tissue samples that were obtained from stripped mullet, summer flounder, and Atlantic menhaden. The metals antimony, arsenic, beryllium, cadmium, chromium, copper, mercury, selenium, silver, and zinc were detected in New River whole body samples at maximum concentrations of 0.23 J, 1.2 J, 0.007 J, 0.02 J, 5.4 J, 4.6 J, 0.014 J, 0.41 J, 0.10 J, and 1.8 J, respectively.

The pesticides detected in the fillet tissue samples were identical to the pesticides found in the whole body samples. The VOCs and SVOCs detected in the whole body samples were considered common laboratory contaminants.

Fillet tissue samples, as with whole body samples, from the stripped mullet, summer flounder, spotted sea trout, and black drum contained metals. Similar concentrations of metals were found in both fillet and whole body samples. Although metals were detected in all species, not all species contained the same metals.

Site 30

This section presents a summary of analytical findings from field sampling activities conducted at Site 30, Sneads Ferry Road Fuel Tank Sludge Area. Table ES-5 provides a summary of site contamination for Site 30 and Table ES-6 provides a comparison of round one and round two groundwater results.

Soils

A total of 14 surface soil samples were collected at Site 30. Eleven of those 14 samples were analyzed for both TCL volatile and semivolatile organics and TAL inorganics. The volatile organic compound 1,1,1-trichloroethane was detected in two surface soil samples retained from Site 30. It was also at estimated concentrations of 2 J and 3 J $\mu\text{g}/\text{kg}$ from soil borings 30-SB06 and 30-SB07, respectively. Soil borings 30-SB06 and 30-SB07 are located adjacent to one another, north of the tank trail. No other positive detections of volatile or semivolatile organic compounds were observed among surface soil samples.

Fourteen of 23 TAL inorganics were detected in the 14 surface soil samples retained from Site 30 (antimony, arsenic, beryllium, cadmium, cobalt, nickel, selenium, silver, and thallium were not detected). None of the positive detections of priority pollutant metals exceeded base-specific (i.e., MCB, Camp Lejeune) background levels for surface soil.

A total of 14 subsurface (i.e., greater than one-foot bgs) soil samples from Site 30 were submitted for laboratory analysis. Eleven of the 14 samples were analyzed for TCL volatile and semivolatile organics and TAL metals; the remaining three subsurface soil samples were analyzed for TAL metals only. Results of these analyses indicate the presence of the organic compound 1,1,1-trichloroethane, detected at an estimated concentration of 2 J $\mu\text{g}/\text{kg}$ in sample 30-SB09, located near the center of the suspected disposal area. No other positive detections of volatile or semivolatile organic compounds were observed among subsurface soil samples.

Seventeen of 23 TAL inorganics were detected in subsurface soils at Site 30 (antimony, beryllium, cadmium, selenium, silver, and thallium were not detected). Chromium was the only TAL metal detected in subsurface soil at concentrations greater than base-specific inorganic background levels. The maximum chromium concentration among subsurface soil samples at Site 30 was 13.2 $\mu\text{g}/\text{kg}$. Four of the 12 chromium detections slightly exceeded the maximum base-specific background concentration. The four detections were scattered throughout the study area.

TABLE ES-5

**SUMMARY OF SITE CONTAMINATION
SITE 30, SNEADS FERRY ROAD FUEL TANK SLUDGE AREA
REMEDIAL INVESTIGATION CTO-0231
MCB, CAMP LEJEUNE, NORTH CAROLINA**

Media	Fraction	Contaminants	Comparison Criteria		Site Contamination				
			ARAR	Base Background	Min.	Max.	Max. Location	Detection Frequency	Spatial Distribution
Surface Soil	Volatiles	1,1,1-Trichloroethane	NA	NA	2 J	3 J	30-SB07	2/11	both detections north of tank trail
	Semivolatiles	ND	NA	NA				0/11	
	Metals (1)	ND	NA	BB				0/14	
Subsurface Soil	Volatiles	1,1,1-Trichloroethane	NA	NA	2 J	2 J	30-SB09	1/11	center of suspected disposal area
	Semivolatiles	ND	NA	NA				0/11	
	Metals (1)	Chromium	NA	0.7 - 10.5	1.5	13.2	30-SB06	12/14	4 exceed BB, scattered
Groundwater	Volatiles (2)	Chloroform	NCWQS - 1.9	NA	3 J	9	30-GW01	1/3	1 exceeds ARAR, both rounds
	Semivolatiles	ND	MCL/NCWQS	NA				0/3	
	Total Metals (3)	Iron	NCWQS - 300	BB	692	692	30-GW03	1/3	1 exceeds ARAR, upgradient
Surface Water	Volatiles	ND	NOAA/NCWQS	NA				0/3	
	Semivolatiles	ND	NOAA/NCWQS	NA				0/3	
	Metals (3)	Lead	NOAA - 1.32	1.2 - 10.4	2.3 J	2.3 J	30-SW01	1/3	1 exceeds ARAR, upgradient
		Mercury	NCWQS - 0.012	0.52	0.15	0.15	30-SW01	1/3	1 exceeds ARAR, upgradient
Sediment	Volatiles	ND	NA	NA				0/6	
	Semivolatiles	BEHP	NA	NA	74 J	3,900	30-SD01	6/6	2 exceed 10X lab/blank contaminant
	Metals (3)	ND	NOAA	BB				0/6	

Notes: - Concentrations are presented in µg/L for liquid and µg/Kg for solids (ppb), metal concentrations for soils and sediments are presented in mg/Kg (ppm).

(1) Metals in both surface and subsurface soils were compared to the range of base background positive detections for priority pollutant metals only

(i.e., antimony, arsenic, beryllium, cadmium, chromium, copper, lead, mercury, nickel, selenium, silver, thallium, zinc).

(2) An additional groundwater sample was collected from the well (30-GW01) which exhibited concentrations of volatiles during the first round.

(3) Metals in groundwater, surface water, and sediment were compared to the range of positive detections in upgradient samples at MCB, Camp Lejeune.

ARAR - Applicable or Relevant and Appropriate Requirements

ND - Not detected

BB - Base background (refer to Appendix M)

NOAA - National Oceanic and Atmospheric Administration

BEHP - bis(2-ethylhexyl)phthalate

MCL - Federal Maximum Contaminant Level

NA - Not applicable

PAH - Polynuclear aromatic hydrocarbon

NCWQS - North Carolina Water Quality Standard

TABLE ES-6

**COMPARISON OF GROUNDWATER ANALYTICAL RESULTS
SITE 30, SNEADS FERRY ROAD FUEL TANK SLUDGE AREA
REMEDIAL INVESTIGATION, CTO-0231
MCB, CAMP LEJEUNE, NORTH CAROLINA**

Detected Contaminants	Round 1 Results				Round 2 Results			
	Min.	Max.	Freq.	Max. Location	Min.	Max.	Freq.	Max. Location
Volatiles								
Chloroform	9	9	1/3	30-GW01	3 J	3 J	1/3	30-GW01
Total Metals								
Aluminum	24,700	136,000 J	3/3	30-GW02	782	2,210	2/3	30-GW03
Arsenic	3.7	25.8	2/3	30-GW02	ND	ND	0/3	NA
Barium	42.7	126	3/3	30-GW02	15	31.4	3/3	30-GW03
Calcium	953	2,220	3/3	30-GW02	1,720	2,080	2/3	30-GW03
Chromium	27.8 J	111 J	3/3	30-GW02	9.3	9.3	1/3	30-GW01
Cobalt	10.5 J	10.5 J	1/3	30-GW02	ND	ND	0/3	NA
Copper	9.6	27.8	3/3	30-GW02	ND	ND	0/3	NA
Iron	4,930	41,400 J	3/3	30-GW02	692	692	1/3	30-GW03
Lead	14.8	59.1	3/3	30-GW01	1.3	1.8	2/3	30-GW03
Magnesium	1,550	7,300	3/3	30-GW02	566	1,320	3/3	30-GW03
Manganese	38.8	181	3/3	30-GW02	7.7	15.3	3/3	30-GW01
Mercury	0.13	0.32 J	3/3	30-GW03	ND	ND	0/3	NA
Nickel	21.7	61.2	3/3	30-GW02	ND	ND	0/3	NA
Potassium	704	7,440 J	3/3	30-GW02	370	447	2/3	30-GW02
Sodium	4,180	8,980	3/3	30-GW02	3,410	15,000	3/3	30-GW03
Vanadium	14.1	123	3/3	30-GW02	ND	ND	0/3	NA
Zinc	237	237	3/3	30-GW02	ND	ND	0/3	NA
Dissolved Metals								
Aluminum	109	135	2/3	30-GW01	ND	ND	0/3	NA
Antimony	37.9 J	37.9 J	1/3	30-GW02	ND	ND	0/3	NA
Barium	9.0	17.3	2/3	30-GW02	12.3	23.7	3/3	30-GW03
Calcium	1,020	2,560	3/3	30-GW02	1,180	2,050	3/3	30-GW03
Copper	6.5	6.5	1/3	30-GW03	9.2	10.4	2/3	30-GW01
Iron	141 J	1,040	2/3	30-GW03	406	406	1/3	30-GW03
Magnesium	643	1,170	3/3	30-GW02	728	1,300	3/3	30-GW03
Manganese	23.3	46.4	2/3	30-GW02	9.0	25.9	3/3	30-GW02
Nickel	7.8	7.8	1/3	30-GW03	ND	ND	0/3	NA
Potassium	625 J	625 J	1/3	30-GW02	199	426	3/3	30-GW02
Sodium	4,580	9,810	3/3	30-GW02	4,090	15,100	3/3	30-GW03

Notes: Groundwater concentrations are presented in µg/L (ppb)

J - Estimated

NA - Not applicable

ND - Not detected

Groundwater

A total of three shallow groundwater samples from Site 30 were submitted for laboratory analysis. The samples were collected from the uppermost portion of the surficial aquifer (i.e., the water table). As indicated in Table ES-5, the detection of organic compounds was limited to monitoring well 30-GW01, located near the center of the study area. Chloroform was the only VOC or SVOC identified during the first sampling round, at a concentration of 9 µg/L.

TAL metals, both total and dissolved fractions, were detected in samples obtained from each of the three monitoring wells at Site 30. Seventeen of the 23 TAL total metals were detected within at least one groundwater sample at Site 30 (antimony, beryllium, cadmium, silver, selenium, and thallium were not detected). Eleven of 23 TAL dissolved metals were also detected within at least one of the three groundwater samples (arsenic, beryllium, cadmium, cobalt, chromium, lead, mercury, silver, selenium, thallium, vanadium, and zinc were not detected). Chromium, iron, lead, and manganese were each detected among the three groundwater samples from Site 30 at concentrations that exceeded either federal or state standards for total metals. Chromium, iron, lead, and manganese were detected at maximum concentrations of 111 J, 41,400 J, 59.1, and 181 µg/L, respectively. None of these positive detections, in excess of either MCL or NCWQS, were above base-specific background levels.

During the second sampling round, groundwater samples from each of the three shallow monitoring wells at Site 30 were submitted for laboratory analysis of TAL metals, both total and dissolved fractions. Additionally, one groundwater sample from 30-GW01 was submitted for volatile organic analysis. Chloroform was once again detected in a groundwater sample obtained from 30-GW01 at an estimated concentration of 3 J µg/L from 30-GW01. No other VOCs were detected.

Total and dissolved TAL metals were detected in each of the three shallow groundwater samples submitted for analysis from Site 30. Ten of 23 TAL total metals were detected in at least one shallow groundwater sample from Site 30 (antimony, arsenic, beryllium, cadmium, cobalt, copper, mercury, nickel, selenium, silver, thallium, vanadium, and zinc were not detected). Eight of 23 TAL dissolved metals were also detected within at least one of the nine groundwater samples (aluminum, antimony, arsenic, beryllium, cadmium, chromium, cobalt, lead, mercury, nickel, selenium, silver, thallium, vanadium and zinc were not detected). Iron was detected during the second sampling round at a concentration in excess of the 300 µg/L NCWQS, based on total metal analyses. Iron was detected at a concentration of 692 µg/L in sample 30-GW03, located approximately 300 yards upgradient of the study area.

Surface Water

Eleven of 23 TAL total metals were positively identified in the three surface water samples submitted for laboratory analysis from Frenchs Creek. Lead and mercury were the only metals identified at concentrations in excess of either NOAA chronic screening values or NCWQS. Both lead and mercury detections were observed in sample 30-SW01, located upgradient of the study area. Lead and mercury were detected at concentrations of 2.3 J and 0.15 µg/L, respectively. No other total metal concentrations were in excess of screening values. Further, volatile and semivolatile compounds were not detected in any of the three surface water samples.

Sediments

Volatile organic compounds were not detected among the six sediment samples retained for analysis from Frenchs Creek. The SVOC BEHP was detected in two Frenchs Creek sediment samples. The concentrations of BEHP at locations 30-SD01 and 30-SD03 were 3,900 and 2,600 µg/kg, respectively. Both detections were in excess of the 1,200 µg/kg laboratory contaminant level and, therefore, are considered to represent an actual observation. Sixteen of 23 TAL metals were detected in at least one of the six sediment samples from Frenchs Creek. No TAL metal concentrations among the six sediment samples exceeded NOAA ER-L screening values.

HUMAN HEALTH RISK ASSESSMENT

Site 1

The potential noncarcinogenic or carcinogenic risks for the current military receptor and future construction worker exposed to the surface soil and subsurface soil at Site 1 were within acceptable levels.

There were potential noncarcinogenic and carcinogenic risks to the future residential child and adult receptors upon exposure to groundwater. The potential noncarcinogenic risks from groundwater are 17.8 and 7.6 for the child and adult receptor, respectively. These values exceed the acceptable level of one. The potential carcinogenic risk from groundwater was 1.8×10^{-4} for the adult receptor. This risk exceeds the range of 1×10^{-4} to 1×10^{-6} . Arsenic and manganese were the primary contaminants of concern (COPCs) contributing to the risks.

On comparison of arsenic and manganese levels in the groundwater to Federal and state MCLs, only manganese exceeds the criteria (i.e., manganese exceeds the state MCL at a frequency of 5 out of 18). Arsenic did not exceed the Federal or state level. Although these two metals contributed to the site risks, only one metal exceeded criteria. The concentration of arsenic that was used to determine potential risk was exceeded at five wells. Three of these wells were located off-site (i.e., wells 1-GW-10, 1-GW-11, and 1-GW-12). The concentration of manganese used to determine potential risk was the maximum level (1,200 µg/L) found at off-site well 1-GW-10. This level was found only once among the shallow and deep wells, excluding another off-site well, 1-GW-11, which had a concentration of 1,070 µg/L. The remaining manganese detections were at least a magnitude less than the maximum level. Although these two metals contributed to the site risks from groundwater exposure, the levels used to calculate risk were primarily from off-site wells, which either did not exceed criteria or exceeded criteria infrequently. Consequently, it is reasonable to assume that the risks from groundwater driven by arsenic and manganese may be overestimates of risk and are highly conservative values.

Site 28

In the current case, potential noncarcinogenic and carcinogenic risks to the military personnel, recreational adult, and fisherman were within acceptable risk levels. For the current recreational child receptor there was a potential noncarcinogenic risk from New River sediment. The noncarcinogenic risk from the ingestion pathway was 1.2, which is slightly greater than the acceptable risk level of one. The COPC driving this noncarcinogenic risk was antimony.

In the future case, the total potential noncarcinogenic risk to the child receptor (i.e., total noncancer risk is 23) exceeds the acceptable risk level of one. This risk is attributed to exposure to groundwater, subsurface soil, and sediment from the New River. For the adult receptor, there were noncarcinogenic and carcinogenic risks from exposure to groundwater. The risks to the construction worker were within acceptable risk levels.

The results indicate that metals in groundwater, subsurface soil, and sediment are driving the potential noncarcinogenic and carcinogenic risks at the site. These metals are antimony, arsenic, copper, and zinc in subsurface soil; manganese in groundwater; and antimony in the sediment of the New River. It is important to note that, upon the segregation of the soil noncarcinogenic risks based on the effects on different target organs, the soil noncarcinogenic risk may be an overestimate.

It also is important to note that the future exposure scenario is based on potential residential development of Site 28. At present, the site is a recreational/picnic area located within training areas on the base. It is highly unlikely that the site will become a residential area in the foreseeable future. Consequently, exposure to subsurface soil and groundwater under a residential scenario is highly conservative and unlikely given the present site conditions. It follows that the potential risks associated with this exposure scenario are conservative and may be overestimated values.

In terms of lead health impacts, use of the lead uptake biokinetic (UBK) model indicates that exposure to surface soil, subsurface soil, and groundwater at this site generates blood lead levels in children that are within acceptable levels.

Site 30

Current and future potential receptors at the site include current military personnel, future residents (i.e., children and adults), and future construction workers. The potential noncarcinogenic and carcinogenic risks associated with exposure to subsurface soil, surface water, and sediment for the receptors evaluated at this site were within acceptable risk levels.

ECOLOGICAL RISK ASSESSMENT

Site 1

Metals appear to be the only site related COPCs that may have the potential to affect the integrity of terrestrial receptors at Site 1. There were no aquatic receptors identified that would be exposed to site related COPCs.

Surface soil quality indicated a slight potential for cadmium and chromium concentrations to decrease the integrity of terrestrial invertebrates or plants at the site. However, because the site concentrations only slightly exceeded the literature values, it is not expected that these contaminants would present a significant ecological risk to these terrestrial receptors.

Other terrestrial receptors may be exposed to the contaminants in the surface soils by ingestion. Based on the comparison of the chronic daily intakes (CDIs) to terrestrial reference values (TRVs) for the deer, rabbit, fox, and quail receptors used in this ERA, there does appear to be an ecological risk to terrestrial vertebrate receptors. However, this risk is expected to be low because of the low level of the exceedances of the terrestrial reference values.

Finally, there were no threatened or endangered species or critical habitats identified at Site 1. Therefore, there is no ecological risk expected to these receptors.

Site 28

In New River surface water, copper exceeded aquatic reference values but at levels that were indicative of a low risk potential. Lead and zinc only exceeded unity slightly at a single station. Copper exceeded the surface water reference values in Cogdels Creek, while, aluminum exceeded the surface water reference values in Orde Pond. However, these exceedances were only slightly above the reference values.

In the sediments, lead exceeded aquatic reference values only once in Cogdels Creek at a low level but exceeded reference values significantly in the New River at one station. Antimony exceeded its sediment aquatic reference values moderately at the same station in the New River. This station may be associated with runoff from the active firing range. Pesticides exceeded the sediment aquatic reference values throughout Cogdels Creek with the highest exceedances in the lower reach of the creek near the confluence with the New River. These exceedances represent a moderate potential for risk to aquatic receptors. The levels detected in the sediments may be a result of routine pesticide application in the vicinity of Site 28, especially near the sewage treatment plant and recreation area.

Results of the analysis of benthic macroinvertebrates and fish populations indicate that Cogdels Creek and this reach of the New River supports an aquatic community that is representative of a tidally-influenced freshwater and estuarine ecosystem with both freshwater and marine species. The absence of pathologies observed in the fish sampled from Cogdels Creek and the New River indicates that the surface water and sediment quality does not adversely impact the fish community. The benthic community demonstrated the typical tidal/freshwater species trend of primarily chironmids and oligochaetes in the upper reaches of Cogdels Creek and polychaetes and amphipods in the lower reaches of Cogdels Creek and in the New River. Species representative of both tolerant and intolerant taxa were present, and the overall community composition did not indicate a benthic community adversely impacted by surface water and sediment quality.

During the habitat evaluation, no areas of vegetation stress or gross impacts from site contaminants were noted. Based on the soil toxicity data for several metals (cadmium, chromium, copper, manganese, nickel, and zinc), these contaminants at Site 28 may decrease the integrity of terrestrial invertebrates or plants at the site. Based on the evaluation of the deer, rabbit, fox, raccoon, and quail used in this ERA, there does appear to be an ecological risk to terrestrial vertebrates. This risk is expected to be significant if greater exposure to these contaminants results.

Finally, the American Alligator has been observed at Site 28. Potential adverse impacts to this threatened or endangered species are low because of to the low levels of most contaminants in its critical habitat.

Site 30

Three metals were detected in the surface water at concentrations that may decrease the integrity of the aquatic community. However, because the concentration of contaminants was higher in the upstream station than in the downstream stations, the metals do not appear to be site related. No COPCs detected in the sediments exceeded any of the sediment aquatic reference values. Therefore, there does not appear to be a significant risk to aquatic receptors from site-related COPCs.

No contaminants detected in the surface soils were retained as COPCs. In addition, the Quotient Index (QI) for the terrestrial food chain model was greater than unity for only one species. The QI for the raccoon was slightly greater than one (1.72). Therefore, there does not appear to be a significant risk to the terrestrial receptors from site-related COPCs.

The red-cockaded woodpecker is known to inhabit Site 30. However, the potential adverse impacts to this protected species is expected to be low since the terrestrial food chain model did not show an adverse risk to bird species.

1.0 INTRODUCTION

Marine Corps Base (MCB), Camp Lejeune was placed on the Comprehensive Environmental Response, Compensation, and Liability Act (CERCLA) National Priorities List (NPL) on October 4, 1989 (54 Federal Register 41015, October 4, 1989). Subsequent to this listing, the United States Environmental Protection Agency (USEPA) Region IV; the North Carolina Department of Environment, Health and Natural Resources (NC DEHNR); and the United States Department of the Navy (DoN) entered into a Federal Facilities Agreement (FFA) for MCB, Camp Lejeune. The primary purpose of the FFA was to ensure that environmental impacts associated with past and present activities at MCB, Camp Lejeune were thoroughly investigated and appropriate CERCLA response/Resource Conservation and Recovery Act (RCRA) corrective action alternatives were developed and implemented, as necessary, to protect public health, welfare, and the environment (FFA, 1989).

The Fiscal Year 1995 Site Management Plan for MCB, Camp Lejeune, a primary document referenced in the FFA, identifies 27 sites that require Remedial Investigation/Feasibility Study (RI/FS) activities. These 27 sites have been divided into 13 operable units to simplify RI/FS activities. This report describes the RI conducted at Operable Unit (OU) No. 7, which is comprised of Sites 1, 28, and 30. Figure 1-1 depicts the location of OU No.7 and Sites 1, 28, and 30. [Note that all tables and figures are presented in the back of each section.]

The purpose of the RI is to evaluate the nature and extent of the threat to public health and the environment caused by the release or threatened release of hazardous substances, pollutants, or contaminants. The RI investigation was conducted by sampling of several media (soil, groundwater, surface water, sediment, and fish tissue) at OU No. 7, evaluating the resultant analytical data, and performing a human health risk assessment (RA) and ecological RA. This RI report contains the results of all field investigations, the human health RA, and the ecological RA. Furthermore, the RI report provides information to support the FS and record of decision (ROD) for a final remedial action.

This RI Report has been prepared by Baker Environmental, Inc. (Baker) and submitted to the USEPA Region IV; the NC DEHNR; MCB, Camp Lejeune Environmental Management Division (EMD); the Navy Environmental Health Center (NEHC); and to the Naval Facilities Engineering Command, Atlantic Division (LANTDIV) for their review.

The following subsections describe the arrangement of OU No. 7 and the background and setting of MCB, Camp Lejeune. In addition, Section 1.1 provides an overview of the RI Report's organization.

1.1 Report Organization

This RI Report is comprised of three text volumes. Each of the three text volumes is dedicated to a single site (i.e., Volume I - Site 1, Volume II - Site 28, and Volume III - Site 30). Appendices are provided in three additional volumes. The following section headings are included within each of the three text volumes and provide site-specific investigation findings:

- Site Background and Setting
- Study Area Investigation
- Site Physical Characteristics

- Nature and Extent of Contamination
- Contaminant Fate and Transport
- Baseline Human Health Risk Assessment
- Ecological Risk Assessment
- Conclusions

1.2 Operable Unit Description

Operable units are formed as an incremental step toward addressing individual site concerns and to simplify the specific problems associated with a site or a group of sites. There are currently 27 Installation Restoration Program (IRP) sites at MCB, Camp Lejeune, which have been grouped into 13 operable units. Sites 1, 28, and 30 were grouped together as OU No. 7 because similar wastes are suspected to have been disposed at each site and the three sites are located relatively close to each other. Figure 1-2 depicts the locations of all 13 operable units at MCB, Camp Lejeune.

OU No. 7 is located on the eastern portion of the base, situated between the New River and Sneads Ferry Road, south of the Hadnot Point Industrial Area (HPIA). Site 1 is referred to as the "French Creek Liquids Disposal Area," Site 28 is the "Hadnot Point Burn Dump," and Site 30 is known as the "Sneads Ferry Road Fuel Tank Sludge Area."

1.3 Background and Setting of MCB, Camp Lejeune

The following section summarizes existing background and setting information which pertains to MCB, Camp Lejeune. This section specifically addresses the location and setting of MCB, Camp Lejeune, its history, topography, geology, hydrogeology, climatology, ecology, land use, and demography.

1.3.1 Location and Setting

MCB, Camp Lejeune is located on the coastal plain of North Carolina in Onslow County. The facility encompasses approximately 234 square miles and is bisected by the New River. The New River flows in a southeasterly direction and forms a large estuary before entering the Atlantic Ocean. The eastern border of MCB, Camp Lejeune is the Atlantic Ocean shoreline. The western and northeastern boundaries of the facility are U.S. Route 17 and State Route 24, respectively. The City of Jacksonville borders MCB, Camp Lejeune to the north.

1.3.2 History

Construction of MCB, Camp Lejeune began in April 1941. The facility was designed to be the "World's Most Complete Amphibious Training Base." The base was started at the Hadnot Point Industrial Area (HPIA) where major functions of the base are still centered. The MCB, Camp Lejeune complex consists of primarily five geographical locations under the jurisdiction of the Base Command. These areas include Camp Geiger, Montford Point, Courthouse Bay, Mainside, and the Rifle Range Area. The three sites included under OU No. 7 are located within the Mainside portion of MCB, Camp Lejeune (WAR, 1983). The general locations of these three sites within MCB, Camp Lejeune are identified on Figure 1-1.

1.3.3 Topography

MCB, Camp Lejeune is located within the Atlantic Coastal Plain physiographic Province of North Carolina. The topography of MCB, Camp Lejeune is relatively flat with ground surface elevations ranging from mean sea level (msl) to 72 feet above msl. Most of MCB, Camp Lejeune, however, lies between 20 and 40 feet above msl. The tidal portion of the Atlantic Coastal Plain, where MCB, Camp Lejeune is situated, is generally flat and swampy. Regional drainage for the area is generally toward the New River and the Atlantic Ocean via the Intercoastal Waterway (Harned, et al., 1989).

1.3.4 Meteorology

Although coastal North Carolina lacks distinct wet and dry seasons, there is some seasonal variation in average precipitation. July tends to receive the most precipitation, and rainfall amounts during summer are generally the greatest. Daily showers during the summer are not uncommon, nor are periods of one or two weeks without rain. Convective showers and thunderstorms contribute to the variability of precipitation during the summer months. October tends to receive the least amount of precipitation, on average. Throughout the winter and spring precipitation occurs primarily in the form of migratory low pressure storms. MCB, Camp Lejeune's average yearly rainfall is approximately 52 inches. Table 1-1 presents a climatic summary of data collected during 27 years (January 1955 to December 1982) of observations at Marine Corps Air Station (MCAS), New River.

Coastal Plain temperatures are moderated by the proximity of the Atlantic Ocean. The ocean effectively reduces the average daily fluctuation of temperature. Lying 50 miles offshore at its nearest point, the Gulf Stream tends to have little direct effect on coastal temperatures. The southern reaches of the cold Labrador Current offset any warming effect the Gulf Stream might otherwise provide.

MCB, Camp Lejeune experiences hot and humid summers; however, ocean breezes frequently produce a cooling effect. The winter months tend to be mild, with occasional brief cold spells. Average daily temperatures range from 38°F to 58°F in January, the coldest month, and 72°F to 86°F in July, the hottest month. The average relative humidity, between 75 and 85 percent, does not vary greatly from season to season.

Observations of sky conditions indicate yearly averages of approximately 112 days clear, 105 partly cloudy, and 148 cloudy. Measurable amounts of rainfall occur 120 days per year, on the average. Prevailing winds are generally from the south-southwest 10 months of the year and from the north-northwest during September and October. The average wind speed for MCAS, New River is 6.95 miles per hour.

1.3.5 Geology

The following sections describe the regional geology of the area. Regional geologic information was obtained from a USGS publication (Harned, et al., 1989).

MCB, Camp Lejeune is situated within the Atlantic Coastal Plain physiographic province. The sediments of the Atlantic Coastal Plain consist mostly of interbedded sands, silts, clays, calcareous clays, shell beds, sandstone, and limestone. These sediments are layered in interfingering beds and lenses that gently dip and thicken to the southeast. These sediments were deposited in marine or

near-marine environments and range in age from early Cretaceous to Quaternary time. Regionally, they comprise 10 aquifers and nine confining units which overlie igneous and metamorphic basement rocks of the pre-Cretaceous age. Table 1-2 presents a generalized stratigraphic column for Jones and Onslow Counties, North Carolina, and geologic cross-sections of the MCB, Camp Lejeune area are presented on Figures 1-3 and 1-4.

1.3.6 Hydrogeology

The information presented concerning the regional hydrogeology is from a USGS publication (Harned, et al., 1989) and from previous investigations conducted near OU No. 7 (ESE, 1988; O'Brien & Gere, 1992; Baker, 1992). Additional information is provided in a technical memorandum prepared by Baker which summarizes groundwater data and aquifer characteristics for MCB, Camp Lejeune (see Appendix S).

USGS studies at MCB, Camp Lejeune indicate that the area is underlain by sand and limestone aquifers. These aquifers include the surficial (water table), Castle Hayne, Beaufort, Peedee, Black Creek, and upper and lower Cape Fear. The combined thickness of these sediments is approximately 1,500 feet. Less permeable clay and silt beds function as confining units or semi-confining units which separate the aquifers and impede the flow of groundwater between aquifers.

The surficial aquifer lies in a series of unconsolidated sediments, primarily sand and clay, which commonly extend to depths of 50 to 100 feet bgs. Although the aquifer is classified as GA (i.e., existing or potential source of drinking water supply for humans), it is not used as potable water source at the MCB, Camp Lejeune because of its low yielding production rates (typically less than 3 gpm). A semi-confining unit underlies the surficial aquifer within some portions of MCB, Camp Lejeune.

A number of aquifer pump tests have been conducted within the surficial aquifer in the vicinity of OU No.7. A short term pump test performed by O'Brien & Gere (1990) at the HPIA Fuel Farm determined the following aquifer parameters:

- transmissivity = 500 gallons/day/foot (gpd/ft)
- well yield = 3 gallons per minute (gpm)
- hydraulic conductivity = 3.3 feet/day
- radius of influence = 300 to 400 feet
- saturated thickness = 19 to 22 feet

Additionally, Baker (1992) conducted two pump tests within the surficial aquifer, one within the HPIA and the other adjacent to Site 28 near the HPIA sewage treatment plant (Building 21). Test results indicated the following ranges of aquifer parameters:

- transmissivity = 561 to 1,164 gpd/ft
- well yield = 2 to 3 gpm
- hydraulic conductivity = 2.8 to 3.1 feet/day
- radius of influence = 50 to 90 feet
- saturated thickness = 15 to 20 feet

Water levels in the wells tapping the surficial aquifer vary seasonally. The surficial aquifer receives more recharge in the winter than in the summer when much of the water evaporates or is transpired

by plants before it can reach the water table. The water table generally is highest in the winter and spring and is lowest in the summer and early fall.

The principal water supply aquifer for the MCB, Camp Lejeune lies in a series of sand and limestone beds between 50 and 300 feet bgs. This series of sediments is known as the Castle Hayne. The upper portion of the aquifer is partially unconsolidated sand and limestone. The Castle Hayne thickens toward the southeast, from 175 feet in the northern portion of MCB, Camp Lejeune to 375 feet at the coast. Estimated transmissivity and hydraulic conductivity values for the Castle Hayne aquifer range from 32,200 to 183,300 gpd/ft and 14 to 82 feet/day, respectively. An aquifer pump test conducted by ESE (1988) in the HPIA, using an existing water supply well (HP-642), indicated an average transmissivity and storage coefficient of 9,600 gpd/ft and 8.8×10^{-4} , respectively (ESE, 1988).

Recharge to the drinking water aquifer at MCB, Camp Lejeune is directly related to the amount of recharge it receives from the surficial aquifer (Geophex, Ltd, 1991). Recharge for the surficial aquifer is based on an average rainfall of 52 inches per year and an average recharge of 30 percent, or an annual recharge of approximately 16 inches per year. The remaining 70 percent of the rainfall is lost as surface runoff and evapotranspiration. Sixteen inches of recharge equates to 760,000 gallons per day (gpd) per square mile or approximately 114,000,000 gpd for all of MCB, Camp Lejeune (based on 150 square miles of recharge area). Accordingly, the recharge rate far exceeds the demand for consumptive usage.

MCB, Camp Lejeune lies in an area where the Castle Hayne aquifer contains freshwater. Saltwater in the deeper layers just below the aquifer and the New River estuary is of concern in managing water withdrawals from the aquifer. Overpumping of the deeper parts of the aquifer could cause saltwater intrusion. The aquifer underlying most of the area contains water having less than 250 milligrams per liter (mg/L) of chloride. Groundwater having chloride concentrations less than 250 mg/L are considered existing or potential sources of drinking water classified as "GA" by the NC DEHNR.

1.3.7 Land Use and Demography

MCB, Camp Lejeune encompasses an area of approximately 234 square miles. The Installation border is approximately 70 miles, including 14 miles of ocean front and Intracoastal Waterway. Recently, MCB, Camp Lejeune acquired approximately 41,000 additional acres in the Greater Sandy Run area.

Land usage within MCB, Camp Lejeune is influenced by topography and ground cover, environmental policy, and base operational requirements. Much of the land within MCB, Camp Lejeune consists of freshwater swamps that are wooded and largely unsuitable for development. In addition, 3,000 acres of sensitive estuary and other areas set aside for the protection of threatened and endangered species are to remain undeveloped. Operational restrictions and regulations, such as explosive quantity safety distances, impact-weighted noise thresholds, and aircraft landing and clearance zones, may also greatly constrain and influence development (Master Plan, Camp Lejeune Complex, North Carolina, 1988).

The combined military and civilian population of the MCB, Camp Lejeune/Jacksonville area is approximately 112,000. Nearly 90 percent of the surrounding population resides within urbanized areas. Due to the rapid population growth of Jacksonville and adjacent communities, particularly

during the period from 1940 to 1960, MCB, Camp Lejeune continues to have a direct affect on regional population and development.

The French Creek Development Area, where Site 1 is located, is situated southeast of Hadnot Point and is accessible via the Main Service Road. Since its planning in the 1970 Base Master Plan, French Creek has evolved into a self-supportive, campus-like development. A total of about 583 acres have been developed thus far. Supply/storage and maintenance facilities comprise over 58 percent of the development of French Creek, which is the largest amount of supply/storage base-wide. Troop housing occupies nearly 21 percent (122 acres) of the developed area (Master Plan, Camp Lejeune Complex, North Carolina, 1988).

The development of the HPIA, where Site 28 is located, evolved over a 40-year period and includes approximately 1,080 acres of land. Land uses tend to be integrated with one another, creating an environment which is residential and industrial. Community and recreational land uses are scattered throughout the regimental area which covers about 18 percent (196 acres) of all the developed land within Hadnot Point. Administrative uses are situated within the central portion of Hadnot Point along the main entrance routes, making them easily accessible to visitors and regimental personnel alike. Segregated from the administrative personnel support and troop housing uses are supply/storage and maintenance facilities which are consolidated in the eastern portion of Hadnot Point. (Master Plan, Camp Lejeune Complex, North Carolina, 1988).

Land usage in the Site 30 area is primarily for military training. The area in the immediate vicinity of the site is undeveloped no structures are present. Combat Town Training Area is located southeast of the site. An environmentally sensitive habitat area, restricted from development, is situated to the immediate west of Site 30.

1.3.8 Ecology

MCB, Camp Lejeune is located on North Carolina's coastal plain. A number of natural communities are present within this region. Subcommunities and variations of these major community types are present and alterations of natural communities have occurred in response to disturbance and intervention (i.e., forest cleared to become pasture). The natural communities found in the area are summarized as follows:

- Mixed Hardwood Forest - Found generally on slopes of ravines. Beech is an indicator species with white oak, tulip, sweetgum, and holly.
- Southeastern Evergreen Forest - Dominated by pines, especially longleaf pine.
- Loblolly Pine/Hardwoods Community - Second growth forest that includes loblolly pine with a mix of hardwoods - oak, hickory, sweetgum, sour gum, red maple, and holly.
- Southern Floodplain Forest - Occurs on the floodplains of rivers. Hardwoods dominate with a variety of species present. Composition of species varies with the amount of moisture present.

- Maritime Forest - Develops on the lee side of stable sand dunes protected from the ocean. Live oak is an indicator species with pine, cedar, yaupon, holly, and laurel oak. Deciduous hardwoods may be present where forest is mature.
- Pocosins - Lowland forest community that develop on highly organic soils that are seasonally flooded. Characterized by plants adapted to drought and acidic soils low in nutrients. Pond pine is dominant tree with dense layer of evergreen shrubs. Strongly influenced by fire.
- Cypress Tupelo Swamp Forest - Occurs in the lowest and wettest areas of floodplains. Dominated by bald cypress and tupelo.
- Freshwater Marsh - Occurs upstream from tidal marshes and downstream from non-tidal freshwater wetlands. Cattails, sedges, and rushes are present. On the coast of North Carolina swamps are more common than marshes.
- Salt Marsh - Regularly flooded, tidally influenced areas dominated by salt-tolerant grasses. Saltwater cordgrass is a characteristic species. Tidal mud flats may be present during low tide.
- Salt Shrub Thicket - High areas of salt marshes and beach areas behind dunes. Subjected to salt spray and periodic saltwater flooding. Dominated by salt resistant shrubs.
- Dunes/Beaches - Zones from the ocean shore to the maritime forest. Subjected to sand, salt, wind, and water.
- Ponds and Lakes - Low depressional areas where water table reaches the surface or where ground is impermeable. In ponds rooted plants can grow across the bottom. Fish populations managed in these ponds include redear, bluegill, largemouth bass, and channel catfish (USMC, 1987).
- Open Water - Marine and estuarine waters as well as all underlying bottoms below the intertidal zone.

MCB, Camp Lejeune covers approximately 234 square miles, 84 percent of which is forested (USMC, 1987). Approximately 45.1 percent of this is pine forest, 22 percent is mixed pine/hardwood forest, and 16.8 percent is hardwood forest. Nine percent of the base, a total of 3,587 acres, is wetland and includes pure pond pine stands, mixed pond pine/hardwood, marshes, pocosins, and wooded swamps. The base also contains 80 miles of tidal streams, 21 miles of marine shoreline, and 12 freshwater ponds. The soil types range from sandy loams to fine sand and muck, with the dominant series being sandy loam (USMC, 1987).

The base drains primarily to the New River or its tributaries. These tributaries include Northeast Creek, Southwest Creek, Cogdels Creek, Wallace Creek, Frenchs Creek, Bear Head Creek, and Duck Creek. Site-specific information on surface water and drainage features is presented in the Physical Characteristics section for each site.

SECTION 1.0 TABLES

TABLE 1-1

CLIMATIC DATA SUMMARY
 MARINE CORPS AIR STATION, NEW RIVER
 REMEDIAL INVESTIGATION, CTO-0231
 MCB, CAMP LEJEUNE, NORTH CAROLINA

	Precipitation (Inches)			Relative Humidity (Percent)	Temperature (Fahrenheit)			Mean Number of Days With				
	Maximum	Minimum	Average		Maximum	Minimum	Average	Precipitation		Temperature		
								>=0.01"	>=0.5"	>=90F	>=75F	<=32F
January	7.5	1.4	4.2	76	54	34	44	11	2	0	1	14
February	7.0	1.5	3.8	74	57	36	46	9	3	0	1	11
March	8.0	0.8	3.5	78	64	42	53	10	2	0	5	7
April	6.5	0.5	3.0	79	73	51	62	8	2	-- ⁽¹⁾	14	--
May	8.4	1.7	4.3	86	80	60	70	10	3	2	25	0
June	11.8	2.4	5.8	85	85	67	76	11	4	6	29	0
July	14.3	4.5	8.0	85	88	72	80	14	5	12	31	0
August	12.6	1.7	6.1	87	87	71	80	12	4	11	31	0
September	12.2	1.4	4.7	87	83	66	75	9	3	3	27	0
October	6.5	0.7	2.8	82	74	54	64	7	2	--	16	--
November	5.7	0.6	2.6	80	66	44	55	7	1	0	6	4
December	6.1	0.4	4.0	77	58	37	48	9	2	0	2	11
Annual	14.3	0.4	52.8	81	72	53	63	117	33	34	288	47

⁽¹⁾ -- = Less than 0.5 days

Source: Naval Oceanography Command Detachment, Asheville, North Carolina. Measurements obtained from January 1955 to December 1982.

TABLE 1-2

GEOLOGIC AND HYDROGEOLOGIC UNITS OF
 NORTH CAROLINA'S COASTAL PLAIN
 REMEDIAL INVESTIGATION, CTO-0231
 MCB CAMP LEJEUNE, NORTH CAROLINA

Geologic Units			Hydrogeologic Units
System	Series	Formation	Aquifer and Confining Unit
Quaternary	Holocene/Pleistocene	Undifferentiated	Surficial aquifer
Tertiary	Pliocene	Yorktown Formation ⁽¹⁾	Yorktown confining unit
	Miocene	Eastover Formation ⁽¹⁾	Yorktown Aquifer
		Pungo River Formation ⁽¹⁾	Pungo River confining unit
			Pungo River Aquifer
		Belgrade Formation ⁽²⁾	Castle Hayne confining unit
	Oligocene	River Bend Formation	Castle Hayne Aquifer
	Eocene	Castle Hayne Formation	Beaufort confining unit ⁽³⁾
	Paleocene	Beaufort Formation	Beaufort Aquifer
Cretaceous	Upper Cretaceous	Peedee Formation	Peedee confining unit
			Peedee Aquifer
		Black Creek and Middendorf Formations	Black Creek confining unit
	Black Creek Aquifer		
	Cape Fear Formation	Upper Cape Fear confining unit	
		Upper Cape Fear Aquifer	
		Lower Cape Fear confining unit	
	Lower Cretaceous ⁽¹⁾	Unnamed deposits ⁽¹⁾	Lower Cape Fear Aquifer
Lower Cretaceous confining unit			
		Lower Cretaceous Aquifer ⁽¹⁾	
Pre-Cretaceous basement rocks		--	--

⁽¹⁾ Geologic and hydrologic units probably not present beneath MCB, Camp Lejeune.

⁽²⁾ Constitutes part of the surficial aquifer and Castle Hayne confining unit in the study area.

⁽³⁾ Estimated to be confined to deposits of Paleocene age in the study area.

Source: Harned et al., 1989.

TABLE 1-3

PROTECTED SPECIES WITHIN MCB, CAMP LEJEUNE
 REMEDIAL INVESTIGATION, CTO-0231
 MCB, CAMP LEJEUNE, NORTH CAROLINA

Species	Protected Classification
American alligator (<i>Alligator mississippiensis</i>) ⁽²⁾	T(f), T(s)
Bachmans sparrow (<i>Aimophila aestivalis</i>) ⁽¹⁾	SC
Black skimmer (<i>Rhynchops niger</i>) ⁽¹⁾	SC
Green (Atlantic) turtle (<i>Chelonia m. mydas</i>) ⁽²⁾	T(f), T(s)
Loggerhead turtle (<i>Caretta caretta</i>) ⁽²⁾	T(f), T(s)
Peregrine falcon (*) ⁽¹⁾	(*)
Piping plover (<i>Charadrius melodus</i>) ⁽¹⁾	T(f), T(s)
Red-cockaded woodpecker (<i>Picoides borealis</i>) ⁽³⁾	E(f), E(s)
Rough-leaf loosestrife (<i>Lysimachia asperulifolia</i>) ⁽⁴⁾	E(f), E(s)

Legend: SC= State Special Concern
 E(f) = Federal Endangered
 E(s) = State Endangered
 T(f) = Federal Threatened
 T(s) = State Threatened

* The observer did not differentiate between the American eastern peregrine falcon [E(f), E(s)] or the Arctic peregrine falcon [T(f), T(s)].

Source: (1) Fussell, 1991
 (2) USMC, 1991
 (3) Walters, 1991
 (4) LeBlond, 1991

SECTION 1.0 FIGURES

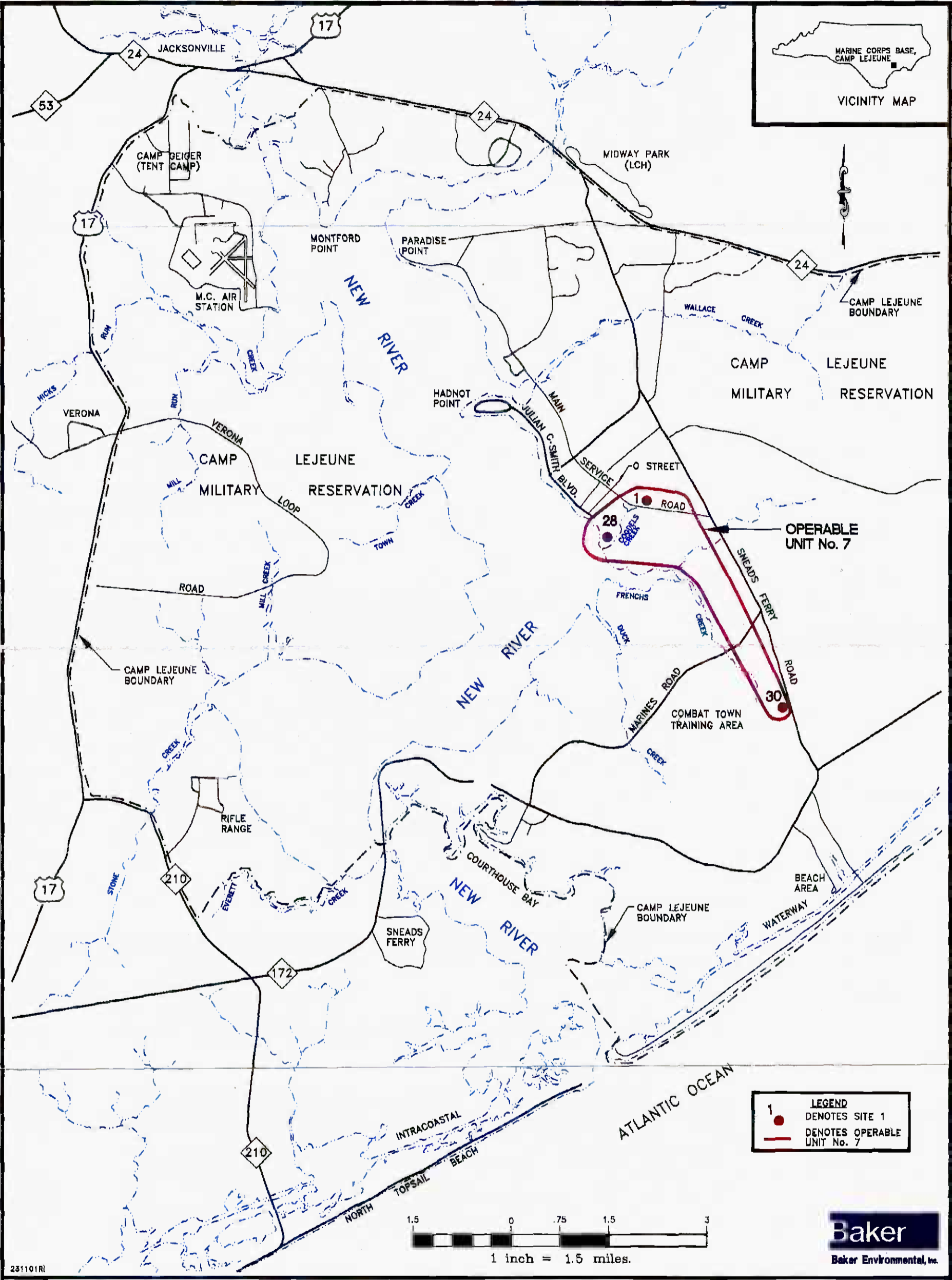

FIGURE 1-1
 OPERABLE UNIT No. 7 - SITES 1, 28, AND 30
 MARINE CORPS BASE CAMP LEJEUNE
 REMEDIAL INVESTIGATION CTO-0231

MARINE CORPS BASE, CAMP LEJEUNE
 NORTH CAROLINA

01499U01Y

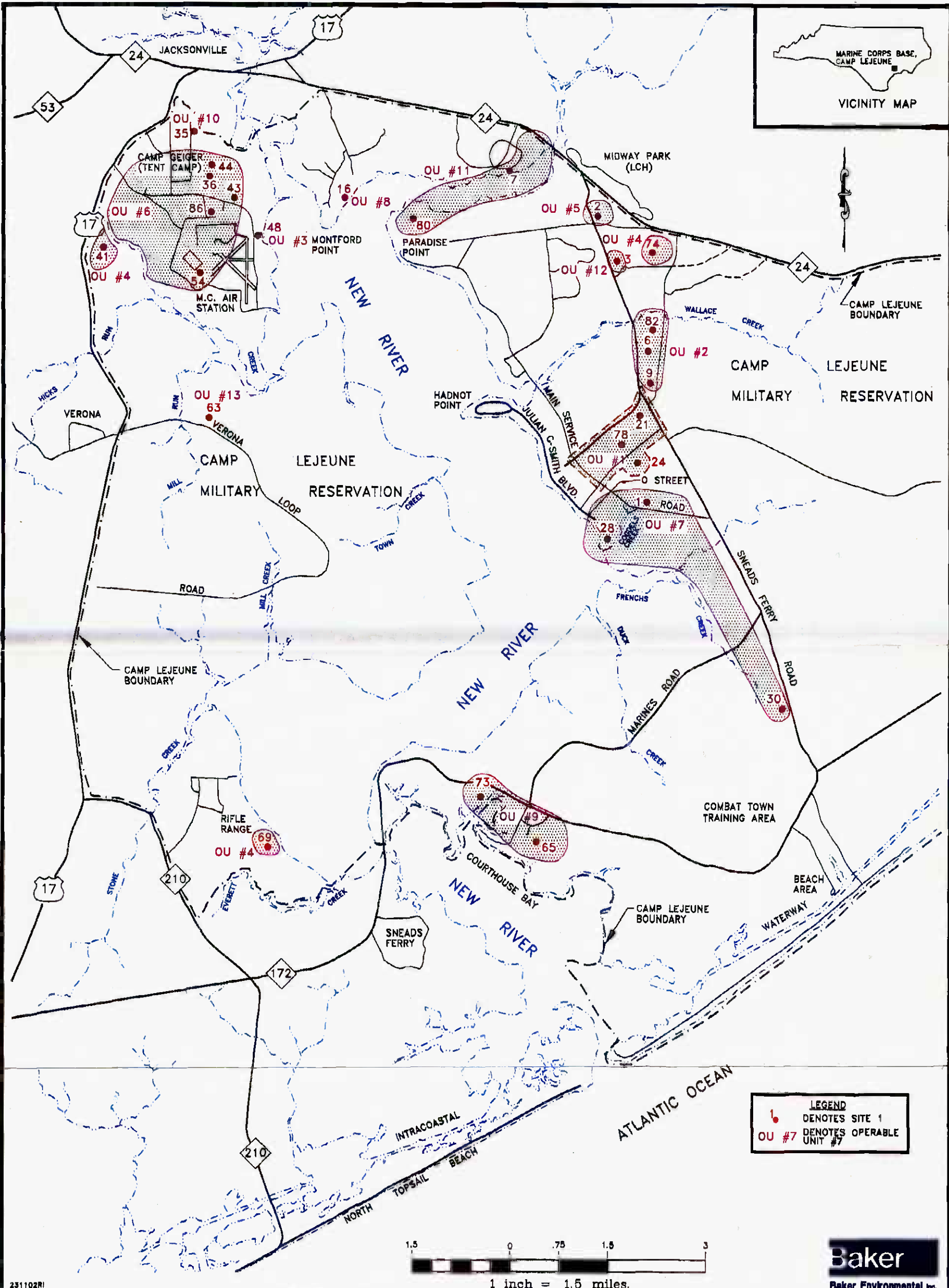
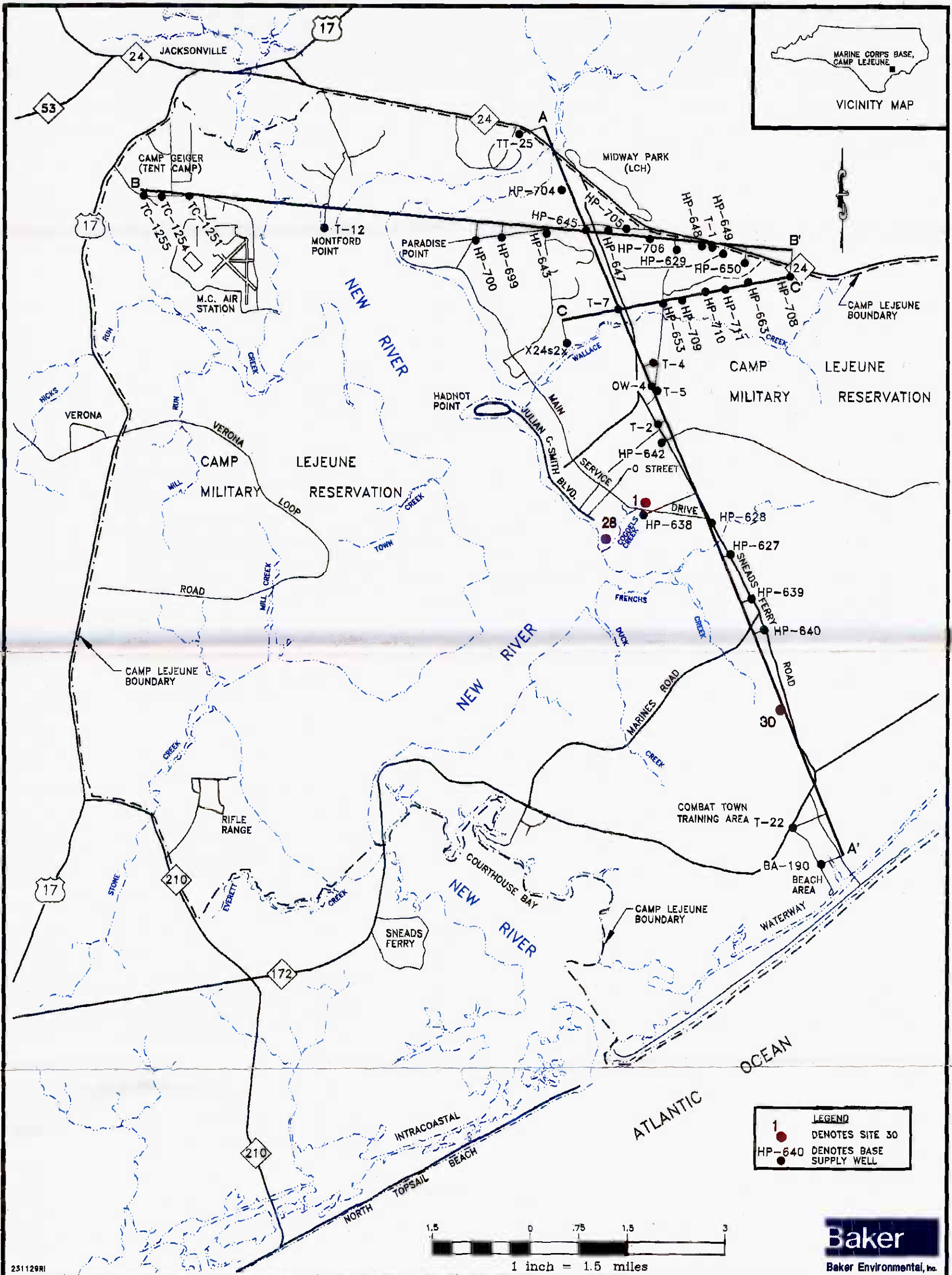

FIGURE 1-2
 OPERABLE UNITS AND SITE LOCATIONS
 MARINE CORPS BASE CAMP LEJEUNE
 REMEDIAL INVESTIGATION CTO-0231
 MARINE CORPS BASE, CAMP LEJEUNE
 NORTH CAROLINA

01499 U02V



231129R1

SOURCE: DEPT. OF INTERIOR,
WATER-RESOURCES INVESTIGATIONS
REPORT, 89-4096, PLATE 4

FIGURE 1-3
LOCATIONS OF HYDROGEOLOGIC CROSS-SECTIONS
MARINE CORPS BASE CAMP LEJEUNE
REMEDIAL INVESTIGATION CTO-0231

MARINE CORPS BASE, CAMP LEJEUNE
NORTH CAROLINA

014991103V

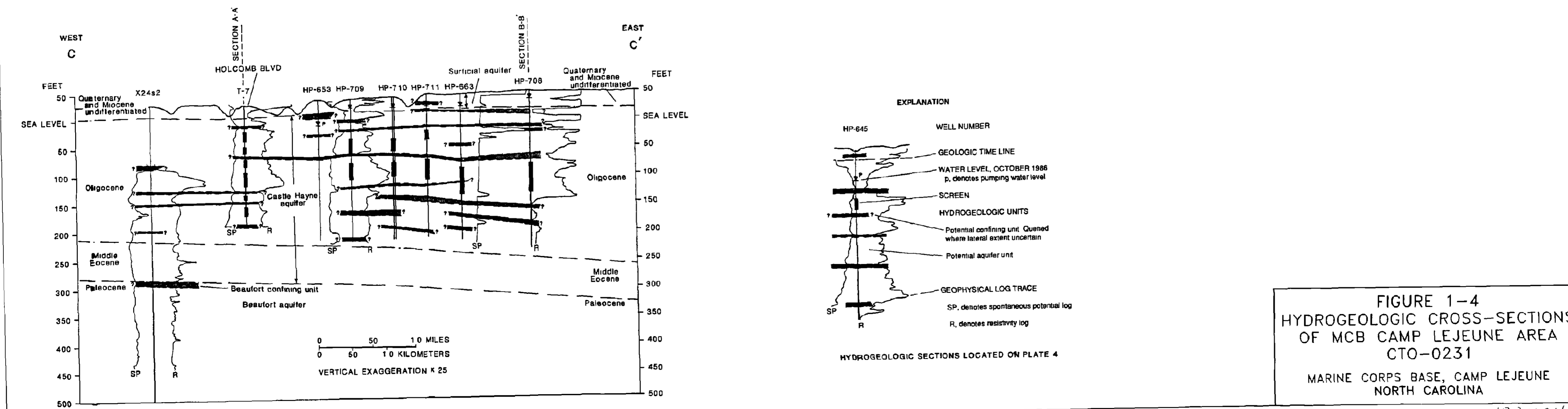
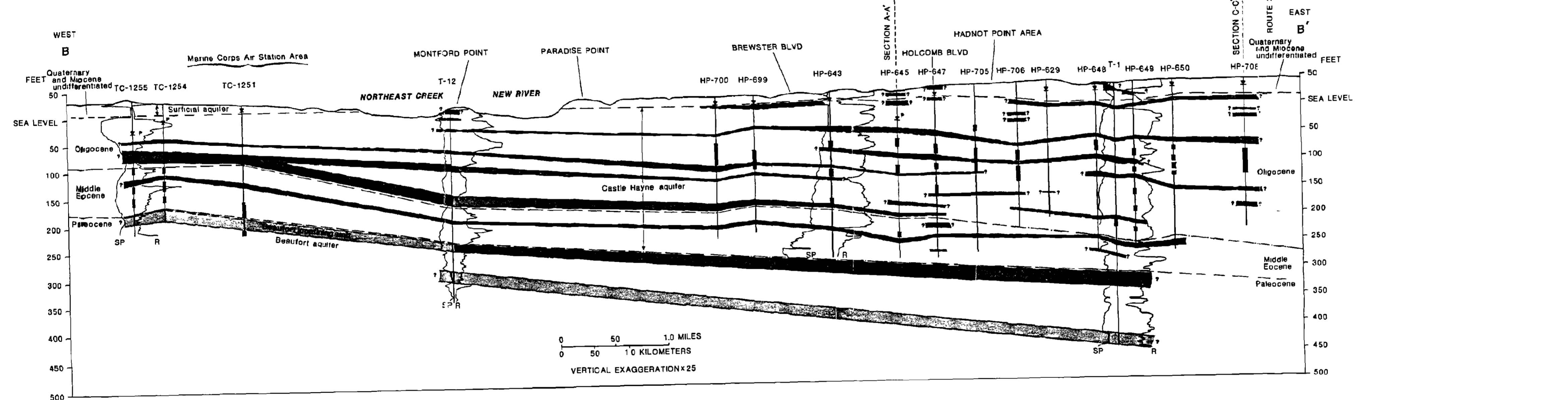
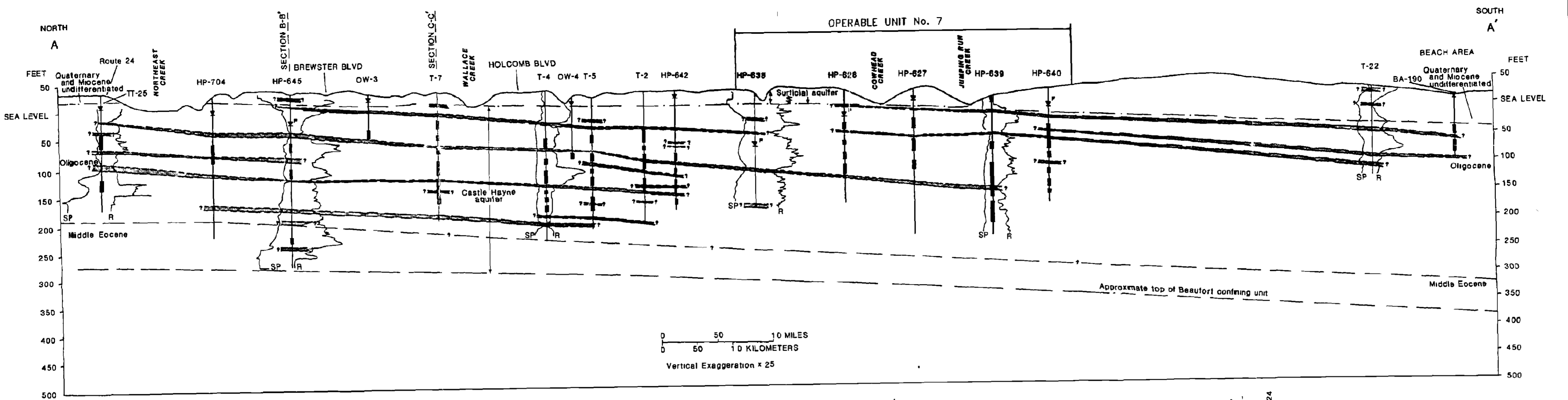

FIGURE 1-4
 HYDROGEOLOGIC CROSS-SECTIONS
 OF MCB CAMP LEJEUNE AREA
 CTO-0231
 MARINE CORPS BASE, CAMP LEJEUNE
 NORTH CAROLINA

HYDROGEOLOGIC SECTIONS A-A', B-B', AND C-C' AT CAMP LEJEUNE, NORTH CAROLINA

01477004X

2.0 SITE BACKGROUND AND SETTING

This section describes the physical setting and provides a detailed history of both operations and previous investigations at Site 1, one of the three sites which comprise OU No. 7.

2.1 Site Description

Site 1, the French Creek Liquids Disposal Area, is located approximately one mile east of the New River and one mile southeast of HPIA on the Mainside portion of MCB, Camp Lejeune (see Figure 1-1). The site is bisected by the Main Service Road which runs east-west.

The majority of Site 1 is comprised of paved (i.e., asphalt, concrete) or improved (i.e. coarse gravel) road surface, parking lots, storage lots, buildings, and equipment maintenance racks. Figure 2-1 provides a map detailing Site 1 and the surrounding area. As previously mentioned, Main Service Road bisects the site, forming "northern" and "southern" study areas. The northern portion of the site is bordered to the north by woods and a motor-cross training area, to the east by a vehicle storage area associated with Building FC-100, to the south by Main Service Road, and to the west by woods and Building FC-115. Suspected petroleum, oil, and lubricant (POL) and battery acid disposal areas lie within two fenced compounds that are associated with Buildings FC-120 and FC-134, on the northern portion of the site. The remaining portion of the "northern" disposal area is located outside of these fenced compounds, to the west and immediately adjacent to Building FC-134.

Building FC-120, located on the northern portion of the site (see Figure 2-1), serves as a motor transport maintenance facility for the Second Landing Support Battalion. Building FC-134, located to the north of Building FC-120, provides offices and communication equipment storage for the second battalion. Building FC-120 is a two story brick structure with several vehicle maintenance bays and offices; Building FC-134 is a single story brick structure with offices and one garage bay.

Two equipment wash areas are located on the northern portion of the site. The first wash area is located to the east of Building FC-134 and the second lies to the west of Building FC-120. Both equipment wash areas are concrete-lined and employ an oil and water separator collection basin. Another oil and water separator is located to the north of Building FC-120, adjacent to Building SF-118. Discharge from the three oil and water separators flows into a drainage ditch and sediment retention pond to the north of the study area.

A number of covered material storage areas (i.e., SFC-118, SFC-124, SFC-125, and SFC-145) are located to the north and west of Building FC-120 (see Figure 2-1). These smaller covered structures are used for temporary storage of paint, compressed gasses, vehicle maintenance fluids, spent or contaminated materials, and batteries. In addition to these covered storage structures, an above ground storage tank (AST) area, located adjacent to the northern side of Building FC-120, is utilized to store spent motor oil and ethylene glycol (i.e., anti-freeze).

A gasoline service island, located to the west of Building FC-120, provides fuel for vehicles undergoing maintenance (see Figure 2-1). Two underground storage tanks (USTs) of unknown capacity are associated with this active service island. Building FC-120 and its associated maintenance facilities, including the gasoline service island, were constructed in 1984. The two

USTs are scheduled to be replaced with one AST before 1996. During their removal any petroleum contaminated soils are also to be removed.

The southern portion of the site is bordered by Main Service Road to the north, Daly Road and a wooded area to the east, H.M. Smith Boulevard to the south, and a wooded area and Gonzales Boulevard to the west. Within this portion of the site is another suspected POL and battery acid disposal area. Vehicle access to the suspected southern disposal area is via a swing-arm gate along Main Service Road. A portion of the southern disposal area is enclosed within a barbed-wire fence; the vehicle and equipment Administrative Deadline Lot (ADL), the remaining area, is not fenced.

The southern portion of the site has several buildings located adjacent to the suspected POL and battery acid disposal area. The buildings are constructed of either formed metal, concrete block, or wood frame siding. Typically the buildings are set on a poured concrete slab and have raised-seam metal roofs. These buildings house a number of support offices, recreation facilities, machine shops, light-duty vehicle and equipment maintenance bays, and equipment storage areas. Heat is provided to the majority of these buildings by kerosene-fired stoves; kerosene fuel is stored in several ASTs located beside a majority of the buildings.

Three vehicle maintenance ramps are located on the southern portion of the site. The first ramp is located immediately to the south of Building FC-739 and the second lies to the north of Building GP-19 (see Figure 2-1). Both maintenance ramps are constructed of concrete and are used for the upkeep of vehicles and equipment. Two oil and water separator collection basins are also located on the southern portion of the site. One of the separators is located to the south of the Building FC-739 vehicle maintenance ramp, and the other is located to the south of Building FC-816, adjacent to an equipment wash area. Discharge from the separator and wash area, located south of Building FC-816, flows into a stormwater sewer and then into a drainage ditch adjacent to H.M. Smith Boulevard.

A concrete-lined and bermed material storage area is also located on the southern portion of the site, to the north of Building FC-816. This bermed area is used for the temporary storage of vehicle maintenance fluids, spent or contaminated materials, fuel, and batteries. In addition, a number of storage lockers are located throughout the southern portion of the site. These lockers are used to store paints and other flammable materials used by maintenance and machine shop personnel.

The New River is located approximately one mile west of Site 1. A drainage ditch lies adjacent to the southern portion of the site along H.M. Smith Boulevard. The ditch flows west toward the HPIA Sewage Treatment Plant (i.e., near Site 28) and empties into Cogdels Creek, which discharges into the New River. The majority of the site is situated on a topographic high area with surface drainage predominantly to the west.

2.2 Site History

Site 1 has been used by several different mechanized, armored, and artillery units since the 1940s. Liquid wastes generated from the maintenance of vehicles were routinely poured onto the ground surface. These wastes have been reported to be primarily petroleum, oil, and lubricants (POL). In addition, battery acid is also reported to have been disposed at this site (Water and Air Research, 1983). The total extent of the suspected disposal area is estimated to be between seven and eight acres.

Acid from dead batteries is reported to have been hand carried from maintenance buildings to a disposal point. At times, holes were dug for waste acid disposal and immediately backfilled. During motor oil changes, vehicles were driven to a disposal point and drained of used oil. The suspected POL and acid disposal areas were not necessarily comparable. Quantities of these wastes have been estimated to be between 5,000 and 20,000 gallons of POL waste and between 1,000 and 10,000 gallons of battery acid waste. The site continues to serve as a vehicle and equipment maintenance/staging area (Water and Air Research, 1983).

2.3 Previous Investigations

In response to the passage of CERCLA, the DoN initiated the Navy Assessment and Control of Installation Pollutants (NACIP) program to identify, investigate, and remediate past hazardous waste disposal sites at Navy installations. The NACIP investigations conducted by the DoN consisted of Initial Assessment Studies (IAS), similar to the USEPA's Preliminary Assessments/Site Investigations (PA/SI), and Confirmation Studies, similar to the USEPA's RI/FS. When the Superfund Amendment and Reauthorization Act (SARA) was passed in 1986, the DoN terminated the NACIP program in favor of the Installation Restoration Program (IRP), which adopted the USEPA Superfund procedures. In addition to the IAS and Confirmation Study, an aerial photographic investigation was performed by the USEPA. The aerial photographic investigation addressed site operations between 1938 and 1990, and an interim report was completed in August 1992. A number of additional investigations were initiated by Baker. Supplemental data provided by these additional investigations were gathered in support of a military construction (MILCON) project and the development of RI/FS project plans (pre-scoping investigation). The following sections detail previous investigation activities conducted at OU No.7, Site 1.

2.3.1 Initial Assessment Study

An IAS was conducted at Site 1 by Water and Air Research, Inc. (WAR) in 1983. The IAS identified a number of sites at MCB, Camp Lejeune as potential sources of contamination, including the sites discussed in this RI. The IAS was based upon review of historical records and aerial photographs, field inspections, and personnel interviews to evaluate potential hazards at various sites throughout MCB, Camp Lejeune. Based on an evaluation of existing data, the IAS recommended that a confirmation study at Site 1 be performed to evaluate the necessity of mitigating actions or cleanup operations.

2.3.2 Confirmation Study

A two-part Confirmation Study was conducted by Environmental Science and Engineering, Inc. (ESE) from 1984 through 1986. The Confirmation Study was executed in two separate stages: a Verification Step, performed in 1984, and a Confirmation Step, performed in 1986. The purpose of the Confirmation Study was to investigate potential contaminant source areas identified in the IAS Report. Site 1 was evaluated and consequently was determined to warrant further investigation, based upon suspected contaminants, migration pathways, and pollutant receptors. The Confirmation Study at Site 1 concentrated on potential contaminants in groundwater, surface water, and sediment. Findings from the Confirmation Study conducted by ESE are provided below.

2.3.2.1 Groundwater Investigation

As part of the Verification Step conducted in July 1984, six shallow (i.e., between 20 and 30 feet) groundwater monitoring wells were installed and sampled at Site 1. Five of the wells (1-GW01 through 1-GW05) were installed in the vicinity of the suspected disposal areas and one was placed upgradient (1-GW06) of the suspected disposal areas. In addition, water supply well HP-638, located along Main Service Road and adjacent to the southern disposal area, also was sampled. Figure 2-2 provides the locations of the six shallow monitoring wells and water supply well HP-638. Table 2-1 provides well construction details for the six shallow wells and the supply well. Samples collected from these wells during the Confirmation Study were analyzed for the following:

- Cadmium
- Chromium (total)
- Hexavalent Chromium (1986 only)
- Lead
- Antimony
- Oil and Grease
- Volatile Organic Compounds
- Total Phenols
- Xylenes (1986 only)
- Methylene ketone (MEK) (1986 only)
- Methyl isobutyl ketone (MIBK) (1986 only)
- Ethylene Dibromide (EDB) (1986 only)

Analytical findings from the 1984 and 1986 groundwater sampling rounds are presented in Table 2-2. The various methods of analysis that generated the sampling results and the level of data quality instituted during the Confirmation Study are unknown. During both rounds of sampling, low levels of volatile organic compounds (VOCs) were detected in wells 1-GW01, 1-GW02, and 1-GW05. During the 1984 round only, wells 1-GW03 and 1-GW06 had detectable levels of VOCs. The water supply well, HP-638, did not exhibit VOC contamination above laboratory detection limits. Well 1-GW05 exhibited levels of tetrachloethene (also known as perchlorethene, PCE), at 6.8 µg/L, and trichlorethene (TCE), at 5.2 µg/L, in excess of the established Federal Maximum Contaminant Level (MCL) of 5 µg/L. Wells 1-GW01 and 1-GW02 indicated TCE contaminant levels (4.6 and 3.2 µg/L, respectively) in excess of the North Carolina Water Quality Standard (NCWQS), which is 2.8 µg/L.

Wells 1-GW02, 1-GW03, and 1-GW04 exhibited contamination during the 1984 sampling round above the current MCL for cadmium, which is 5 micrograms per liter (µg/L). The federal action level for lead (15 µg/L) and the NCWQS for lead (15 µg/L) were exceeded in groundwater samples collected during the 1984 investigation from wells 1-GW01 (43 µg/L), 1-GW02 (136 µg/L), 1-GW03 (55 µg/L), and 1-GW06 (51 µg/L). Samples obtained from wells 1-GW02 and 1-GW03 during the 1986 sampling round again exceeded groundwater standards for lead with concentrations of 49.1 and 48.7 µg/L, respectively. Well 1-GW02 was the only well that exceeded the current MCL for chromium (100 µg/L) with concentrations of 160 µg/L (1984) and 110 µg/L (1986). In addition to well 1-GW02, wells 1-GW01 and 1-GW04 exceeded the NCWQS for chromium of 50 µg/L, with concentrations of 94 µg/L (1984) and 54.3 µg/L (1986), respectively.

Oil and grease (O&G) were identified in samples from wells 1-GW01, 1-GW02, 1-GW03, and 1-GW04. Concentrations of O&G were higher in the 1984 round than in the 1986 round and ranged

from not detected to 3 µg/L. Phenols were identified in each of the six shallow monitoring wells. The highest phenol concentration (19 µg/L) was detected in the sample from well 1-GW06, the upgradient well.

2.3.2.2 Surface Water and Sediment Investigation

One surface water and one sediment sample were collected from both Cogdels Creek and a drainage ditch, located adjacent to H.M. Smith Boulevard, in November 1986. The two surface water and sediment sampling stations (1-SW/SE01 and 1-SW/SE02) are depicted on Figure 2-2. Surface water samples were analyzed for the same parameters as samples collected during the 1986 groundwater sampling round. Sediment samples were analyzed for the following:

- Cadmium
- Chromium
- Hexavalent Chromium
- Lead
- Antimony
- Oil and Grease (O&G)
- Total Phenols
- Ethylene Dibromide (EDB)

Surface water samples 1-SW01 and 1-SW02 exhibited concentrations of phenols at 3 and 13 µg/L, respectively. Chromium was detected in surface water sample 1-SW01 at a concentration of 7.3 µg/L. Both surface water samples had very low concentrations (i.e., less than 1.0 µg/L) of O&G. Sediment samples from 1-SE01 and 1-SE02 had chromium concentrations of 20.8 and 3.69 mg/kg and O&G concentrations of 712 and 1,460 mg/kg, respectively. Phenols were detected in the sediment sample collected from 1-SE01 at a concentration of 116 mg/kg.

2.3.2.3 Conclusions and Recommendations

Organic and metal contaminants were identified in samples collected from the shallow aquifer. The same contaminants, however, were not observed in the deeper aquifer, and, therefore, suggest that vertical migration has not occurred. PCE and TCE were identified in a number of samples collected from the shallow aquifer during both the 1984 and 1986 investigations at levels exceeding present regulatory limits. Cadmium, chromium, and lead were also identified in samples obtained from the shallow aquifer at concentrations that, in certain cases, exceeded federal and state groundwater standards. Each media sampled during the Confirmation Study contained detectable concentrations of O&G. The presence of O&G is not uncommon, given that waste petroleum, oil, and lubricants (POL) are known to have been disposed at this location.

The Site Summary Report (ESE, 1990) recommended that further characterization of groundwater quality within the disposal features, identified by the IAS report, be carried out to complete the RI/FS process. In addition to groundwater, a thorough characterization of unsaturated soils within the identified disposal areas would also be required to fulfil existing data requirements. Following the characterization of potentially impacted environmental media, a risk assessment was also recommended to identify unacceptable risks to human health and the environment.

2.3.3 Additional Investigations

In July 1991, LANTDIV initiated a study in an area within the southern portion of the site that was being considered for a MILCON project (i.e., construction). The purpose of this study was to assess soil conditions in an area that would be scheduled for grading and subsequent construction of a building. Construction would not be initiated if soil contamination was detected at the MILCON site. Prior to this study, no soil data were available or generated during the Confirmation Study to assess soil conditions.

Additional groundwater sampling was conducted in April 1993 during the scoping of this RI/FS. The Confirmation Study only analyzed for a selected number of parameters, which limited a complete characterization of groundwater quality at Site 1. In addition, several years had passed between the Confirmation Study and the RI/FS scoping. More current information was deemed to be necessary prior to developing the RI/FS scope of work. The results of these investigations are described below.

2.3.3.1 Groundwater Investigation

During the 1993 supplemental groundwater sampling round, samples were subjected to full target compound list (TCL) organic and target analyte list (TAL) total metal analyses under Contract Laboratory Program (CLP) protocols and Level IV data quality. Water supply well HP-638 and monitoring well 1-GW05 (damaged) were not sampled, and O&G analyses were not stipulated as part of the 1993 round. A duplicate sample collected from well 1-GW06, the upgradient well, indicated low concentrations (i.e., less than 3 J µg/L) of four SVOCs. Pesticide, PCB, and VOC contaminants were not detected in any of the remaining samples.

Wells 1-GW01, 1-GW02, and 1-GW04 exhibited positive detections of beryllium (43.4 µg/L maximum) in excess of the MCL (4 µg/L). Cadmium was detected at an estimated concentration of 12.9 J µg/L from well 1-GW01, in excess of both MCL and NCWQS of 5 µg/L. Chromium and lead were detected in each of the five samples and in two duplicate samples, at concentrations in excess of both federal (chromium MCL 100 µg/L, lead action level 15 µg/L) and NCWQS (chromium 50 µg/L, lead 15 µg/L) criteria. Chromium was detected at concentrations ranging from 172 µg/L to 674 µg/L. The estimated concentrations of lead, detected within each sample, were between 41 J µg/L and 176 J µg/L. Finally, wells 1-GW01, 1-GW02, and 1-GW04 exhibited nickel concentrations of 169 µg/L, 265 µg/L, and 426 µg/L respectively, each exceeding the MCL of 100 µg/L. Table 2-3 provides a summary of inorganic groundwater data collected during the 1993 groundwater investigation.

2.3.3.2 Soil Investigation

Soil sampling activities were conducted in July 1991 to supplement a MILCON construction project. A total of eighteen soil borings were advanced on the southern portion of the site, within proposed building and construction areas. Two soil samples were obtained from each borehole. The first sample was recovered from between the surface and the first two feet below ground surface (bgs). The second sample was obtained from the split spoon interval immediately above the encountered water table, which ranged from 15.9 to 18.7 feet bgs. All soil samples were analyzed for full TCL organics and TAL metals using CLP protocols and Level IV data quality.

The surface soil sample obtained from 1-SB01, located adjacent to the intersection of Daly and Main Service Roads, had a trace amount of toluene (1.0 µg/kg). A subsurface sample obtained from 1-SB03, near 1-SB01, had a methylene chloride concentration of 11 µg/kg. Benzo(a)pyrene was detected at a concentration of 860 µg/kg in a subsurface soil sample collected from 1SB17, located to the west of Site 1 across Gonzales Boulevard. Each of the 18 soil borings had detectable quantities of chromium and lead at each sampling interval, ranging from 2.7 to 9.3 mg/kg and from 1.4 to 32.7 mg/kg, respectively. Manganese was identified in each of the surface soil samples and in 11 of the 18 subsurface samples, ranging from 3.4 to 156 mg/kg.

2.3.3.3 Summary of Additional Investigations

Analytical results from the soil assessment and groundwater investigation performed at Site 1 suggest the presence of inorganic constituents, particularly metals. Concentrations of detected inorganics such as cadmium, chromium, lead, and manganese were, in general, consistent throughout the site. Contaminants were also detected in reference groundwater and soil samples obtained from hydraulically upgradient locations. The distribution and comparable nature of detected inorganic analytes in environmental media at Site 1 suggest that these constituents are found throughout adjoining areas.

2.3.4 **Aerial Photographic Investigation**

In August of 1992, an interim aerial photographic investigation report was completed by the USEPA Environmental Photographic Interpretation Center (EPIC) in Warrenton, Virginia, of the Advanced Monitoring Systems Division in Las Vegas, Nevada. The investigation was performed at the request of the Superfund Support Section of USEPA Region IV. Aerial photographs depicted surface conditions over time at each of the three sites which constitute OU No. 7. Investigation results and photographs were employed to locate and assess potential sources of contamination, and to document past waste disposal activities within the study areas. The following section describes the aerial photographs of Site 1 that were made available through USEPA Region IV. Annotations on the aerial photographs and the accompanying text were not included in the interim aerial photographic investigation report.

Black-and-white aerial photographs from 1944, 1949, 1952, 1956, 1960, 1964, 1984, 1988, and 1990 were made available for examination of surface conditions at Site 1. These photographs were employed to locate and assess potential sources of contamination and to delineate the extent of disposal activities within the study area. Those aerial photographs that indicate significant activity within suspected disposal areas or depict an alteration of surface conditions (i.e., clearing, construction) have been reproduced and are provided as Figures 2-3 through 2-5.

2.3.4.1 Aerial Photograph - October 1949

Figure 2-3 depicts surface conditions at the time of the photograph. Clearing activity on the southern portion of Site 1 was first exhibited in the 1944 photograph. By October 1949, Buildings FC-739 and FC-746 (see Figure 2-3) were constructed within the southern portion of the study area. The newly constructed Main Service Road is present immediately to the north of the two structures, as pictured on Figure 2-3. The cleared vehicle and equipment staging area, first noted in 1944, is also pictured.

2.3.4.2 Aerial Photograph - November 1960

No significant activity was noted in the 1952 or 1956 aerial photographs. Partial clearing of the northern portion of the study area was first observed in 1956; however, no other significant activity was observed. By 1960, a number of buildings have been added to both the northern and southern portions of the study area. Operations on the northern portion of the site have increased since 1956. A number of objects, most likely equipment and vehicles, are arranged in rows on the northern portion of the site, north of Main Service Road. Figure 2-4 depicts surface conditions and operations at the time of the photograph, November 1960. No significant changes in the level of operations or activity were noted on the 1964 aerial photograph.

2.3.4.3 Aerial Photograph - January 1984

By 1984, many of the present-day structures that surround the study area have been erected. A number of buildings and roads have been added to the east, south, and west of the study area. Construction of Building FC-120, located on the northern portion of the site (see Figure 2-1), is depicted on the 1964 aerial photograph. Activity on the southern portion of the site has increased since 1964; additional clearing has occurred during the intervening years. Figure 2-5 depicts operations and surface conditions at the time of the photograph, January 1984. The level of operational activity within the northern and southern portions of Site 1 remained relatively constant in each aerial photograph from 1988 and 1990. Building FC-120 was completed, but no other significant changes were noted from 1984 to 1990.

2.4 Remedial Investigation Objectives

This section defines the RI objectives aimed at characterizing past waste disposal activities at Site 1, assessing potential impacts to public health and environment, and providing feasible alternatives for consideration during preparation of the ROD. The remedial objectives presented in this section have been identified through review and evaluation of existing background information, assessment of potential risks to public health and environment, and consideration of feasible remediation technologies and alternatives. As part of the remedial investigation at Site 1, soil and groundwater investigations were conducted. The information gathered during these investigations was intended to fill previously existing data gaps and to generate information for assessing human health and ecological risks. Table 2-4 presents both the RI objectives identified for Site 1 and the criteria necessary to meet those objectives. In addition, the table provides a general description of the study or investigation efforts required to obtain the necessary information. The studies conducted at Site 1 are described in Section 3.0 of this report.

SECTION 2.0 TABLES

TABLE 2-1

SUMMARY OF MONITORING WELL CONSTRUCTION DETAILS
 CONFIRMATION STUDY
 SITE 1, FRENCH CREEK LIQUIDS DISPOSAL AREA
 REMEDIATION INVESTIGATION, CTO-0231
 MCB, CAMP LEJEUNE, NORTH CAROLINA

Well No.	Well Depth (feet below ground surface)	Screen Interval Depth (feet below ground surface)	Well Diameter	Year Installed	Surface Elevation (feet above sea level)
1-GW01	24.25	(1)	2	1984	13.3
1-GW02	23	9 - 23	2	1984	15.7
1-GW03	23	9 - 23	2	1984	19.76
1-GW04	31.5	17.5 - 31.5	2	1984	22.91
1-GW05	31.0	17 - 31	2	1984	(1)
1-GW06	29.56	(1)	2	1984	25.1
HP-638 (Base Supply Well)	196	106 - 114 126 - 134 190 - 158 162 - 170 176 - 184 188 - 196	8	(1)	(1)

Note: (1) Information is not available.

Source: ESE, 1992

TABLE 2-2

**DETECTED TARGET CONTAMINANTS IN GROUNDWATER
CONFIRMATION STUDY
SITE 1, FRENCH CREEK LIQUIDS DISPOSAL AREA
REMEDIAL INVESTIGATION, CTO-0231
MCB, CAMP LEJEUNE, NORTH CAROLINA**

Parameter	Federal MCLs ⁽¹⁾	North Carolina WQS ⁽²⁾	Well No./Date												
			1-GW01 7/5/84	1-GW01 11/18/86	1-GW02 7/5/84	1-GW02 11/18/86	1-GW03 7/5/84	1-GW03 11/19/86	1-GW04 7/5/84	1-GW04 11/18/86	1-GW05 7/7/84	1-GW05 11/18/86	1-GW06 7/5/84	1-GW06 11/18/86	HP-638 7/5/84
Benzene	5	1	0.5	ND	ND	ND	ND	ND	ND	ND	ND	ND	ND	ND	ND
1,1-Dichloroethane	None	700	ND	ND	ND	ND	ND	ND	ND	ND	ND	2.7	6.7	ND	ND
1,1-Dichloroethylene	7	7	ND	ND	ND	ND	ND	ND	ND	ND	ND	1.1	2.8	ND	ND
Trans-1,2-Dichloroethene	100	70	1.0	3.4	ND	2.0	ND	ND	ND	ND	ND	2.4	2.4	ND	ND
1,1,2,2-Tetrachloroethane	None	None	ND	ND	ND	ND	ND	ND	ND	ND	ND	4	ND	ND	ND
Tetrachloroethene	5	0.7	ND	ND	ND	ND	ND	ND	ND	ND	ND	6.8	ND	ND	ND
1,1,1-Trichloroethane	200	200	ND	ND	ND	ND	ND	ND	ND	ND	ND	ND	ND	14	ND
Trichloroethene	5	2.8	2	4.6	1.3	3.2	ND	ND	ND	ND	ND	5.2	2.2	ND	ND
Toluene	1,000	1,000	ND	ND	ND	ND	0.6	ND	ND	ND	ND	0.9	ND	ND	ND
Cadmium	5	5	ND	ND	7	ND	10	ND	7	ND	ND	ND	ND	ND	ND
Chromium (total)	100	50	94	23.6	160	110	29	26.6	49	54.3	7	ND	34	28.8	ND
Lead	15 ⁽³⁾	15	43	ND	136	49.1	55	48.7	ND	ND	ND	ND	51	ND	ND
Oil & Grease	None	None	2	ND	2	ND	3	0.4	2	ND	ND	ND	ND	ND	ND
Phenols	None	None	2	4	ND	4	2	3	2	ND	2	6	ND	19	ND

ND = Not Detected

Values reported are concentrations in micrograms per liter ($\mu\text{g/L}$); this approximates parts per billion (ppb).

Source: ESE, 1992.

⁽¹⁾ Federal maximum contaminant levels (MCLs) established under the Safe Drinking Water Act of 1986.

⁽²⁾ NCWQS - North Carolina administrative code, Title 15A, NC DEHNR, Subchapter 2L, Section .0202 - Water Quality Standards (WQS) for groundwater, November 8, 1993. Class GA Standards.

⁽³⁾ Federal action level established under the Safe Drinking Water Act of 1986.

TABLE 2-3

**INORGANIC CONTAMINANTS IN GROUNDWATER
REMEDIAL INVESTIGATION SCOPING
SITE 1, FRENCH CREEK LIQUIDS DISPOSAL AREA
REMEDIAL INVESTIGATION, CTO-0231
MCB, CAMP LEJEUNE, NORTH CAROLINA**

Inorganics	Federal MCL ⁽¹⁾	North Carolina WQS ⁽²⁾	Sample I.D./Date Sampled						
			1-GW01 04/15/93	1-GW02 04/15/93	1-GW03 04/15/93	1-GW04D 04/15/93	1-GW04 04/15/93	1-GW06 04/15/93	1-GW06D 04/15/93
Aluminum	None	None	11,200	340,000	158,000	152,000	152,000	233,000	441,000
Antimony	6	None	22.0 R	22.0 R	22.0 R	22.0 R	22.0 R	22.0 R	22.0 R
Arsenic	50	50	33.6 J	57.4 J	21.8 J	7.2 J	6.8 J	17.8 J	21.6 J
Barium	2,000	2,000	350	849	335	833	864	548	813
Beryllium	4	None	18.6 J	43.4	2.7 J	26.0	28.5	3.2 J	5.1 J
Cadmium	5	5	12.9 J	3.0 UJ	3.0 UJ	3.0 UJ	3.0 UJ	3.0 UJ	3.0 UJ
Calcium	None	None	726,000	279,000	39,800	17,200	19,900	8,850	12,100
Chromium	100	50	365	612	172	627	674	193	370
Cobalt	None	None	90.1	90.5	10.1	233	273	15.6	25.7
Copper	1,300	1,000	60.7	117	44.6	104	105	64.8	112
Iron	None	3,000	246,000	560,000	64,500	181,000	198,000	54,600	93,000
Lead	15 ⁽³⁾	15	41.0 J	176 J	62.8 J	40.8 J	45.8 J	78.8 J	103 J
Magnesium	None	None	18,700	22,800	13,600	29,300	31,100	9,400	15,900
Manganese	None	50	1,150	1,220	125	1,720	1,980	202	292
Mercury	2	1.1	1.2 J	1.3 J	0.85 U	0.46 U	2.1 J	1.6 J	1.9 J
Nickel	100	100	169	265	28.5	426	481	51.6	108
Potassium	None	None	† 11,400	16,800	6,940	18,200	19,400	8,750	14,200
Selenium	50	50	10.0 UJ	10.0 UJ	10.0 UJ	2.2 U	2.4 J	10.0 UJ	10.0 U
Silver	None	18	3.0 UJ	3.0 UJ	3.0 UJ	3.0 UJ	3.0 UJ	3.0 UJ	3.0 UJ
Sodium	None	None	19,000	9,810	9,090	16,300	16,400	14,600	18,300

TABLE 2-3 (Continued)

INORGANIC CONTAMINANTS IN GROUNDWATER
 REMEDIAL INVESTIGATION SCOPING
 SITE 1, FRENCH CREEK LIQUIDS DISPOSAL AREA
 REMEDIAL INVESTIGATION, CTO-0231
 MCB, CAMP LEJEUNE, NORTH CAROLINA

Inorganics	Federal MCL ⁽¹⁾	North Carolina WQS ⁽²⁾	Sample I.D./Date Sampled						
			1-GW01 04/15/93	1-GW02 04/15/93	1-GW03 04/15/93	1-GW04D 04/15/93	1-GW04 04/15/93	1-GW06 04/15/93	1-GW06D 04/15/93
Thallium	2	None	3.0 UJ	3.0 UJ	3.0 U	3.0 U	3.0 U	3.0 U	3.0 U
Vanadium	None	None	332	640	230	517	549	214	412
Zinc	None	2,100	453 U	912 U	244 U	1,110	1,250	315 U	449 U
Cyanide	200	154	10.0 U	10.0 U	10.0 U	10.0 U	10.0 U	10.0 U	10.0 U

- Notes: J - Analyte present. Reported value may not be accurate or precise.
 U - Not detected above the level reported in laboratory or field blanks.
 UJ - The reported quantitation limits are estimated.
 R - Unreliable result. Analyte may or may not be present in the sample.

Values reported are concentrations in micrograms per liter ($\mu\text{g/L}$); this approximates parts per billion (ppb).

- ⁽¹⁾ Federal maximum contaminant levels (MCLs) established under the Safe Drinking Water Act of 1986.
⁽²⁾ NCWQS - North Carolina administrative code, Title 15A, NC DEHNR, Subchapter 2L, Section .0202 - Water Quality Standards (WQS) for groundwater, November 8, 1993. Class GA Standards.
⁽³⁾ Federal action level established under the Safe Drinking Water Act of 1986.

TABLE 2-4

**SUMMARY OF REMEDIAL INVESTIGATION OBJECTIVES
SITE 1 - FRENCH CREEK LIQUIDS DISPOSAL AREA
REMEDIAL INVESTIGATION, CTO-0231
MCB, CAMP LEJEUNE, NORTH CAROLINA**

Medium or Area of Concern	RI/FS Objective	Criteria for Meeting Objective	Proposed Investigation Study
1. Soil	1a. Assess the extent, if any, of soil contamination at suspected acid and POL disposal areas.	Characterize contaminant levels in surface and subsurface soils at suspected disposal areas.	Soil Investigation
	1b. Assess human health and ecological risks associated with exposure to soils.	Characterize contaminant levels in surface and subsurface soils at the site.	Soil Investigation Risk Assessment
	1c. Determine whether or not the suspected POL and acids are sources of groundwater contamination.	Characterize volatile, semivolatile, metal, and TPH levels in surface and subsurface soils at suspected disposal areas.	Soil Investigation
2. Groundwater	2a. Assess health risks posed by potential future usage of the shallow groundwater.	Evaluate groundwater quality and compare to ARARs and health-based action levels.	Groundwater Investigation Risk Assessment
	2b. Define hydrogeologic characteristics for fate and transport evaluation and remedial technology evaluation, if required.	Estimate hydrogeologic characteristics of the shallow aquifer (flow direction, transmissivity, permeability, etc.).	Groundwater Investigation

SECTION 2.0 FIGURES

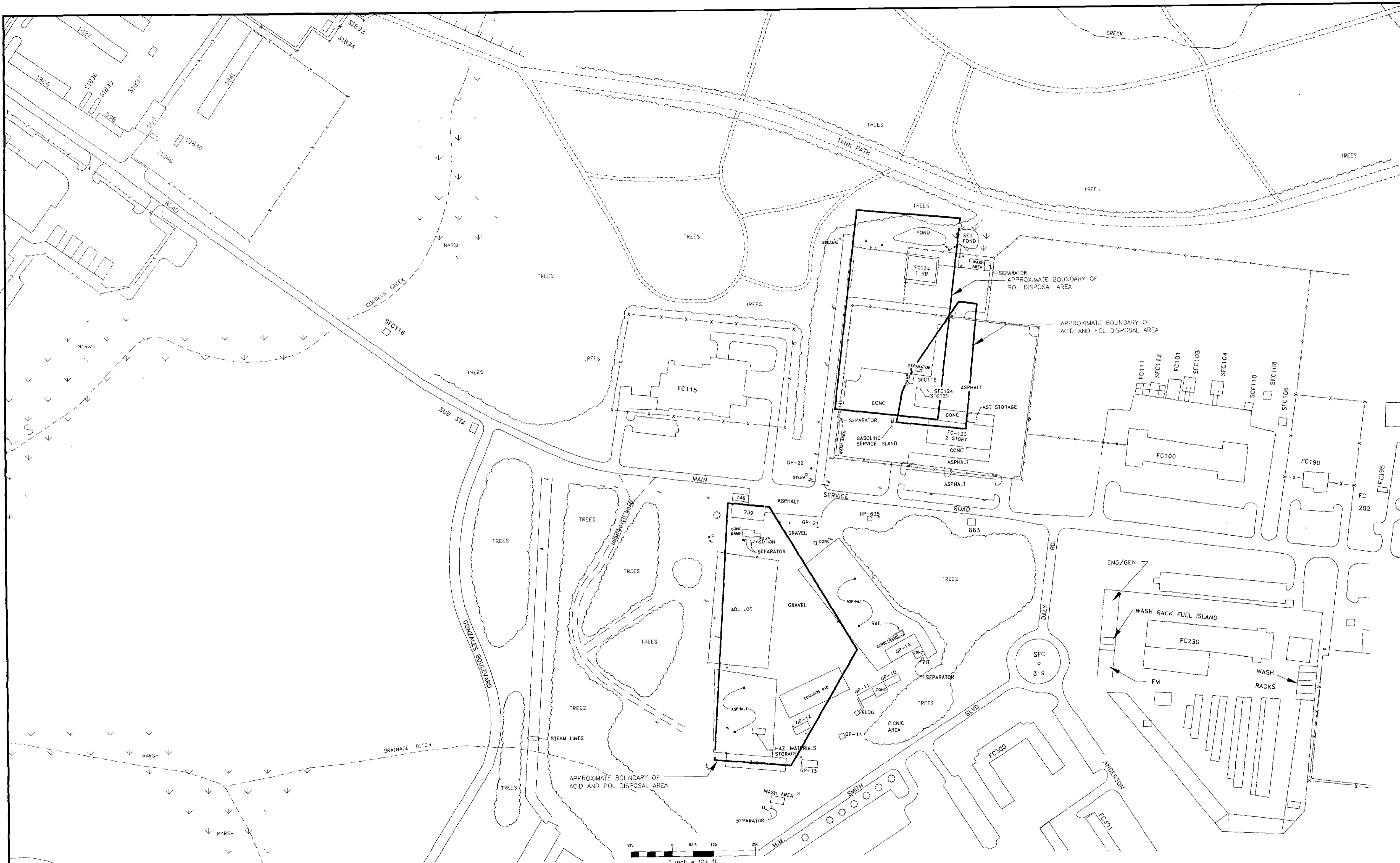

LEGEND	
	VEGETATION
	FENCE
	CREEK/DRAINAGE
	MARSH

DATE	JANUARY 1995
SCALE	1" = 125'
DRAWN	REL
REVIEWED	TFT
S O #	62470-231-0000
CADD#	231103RI

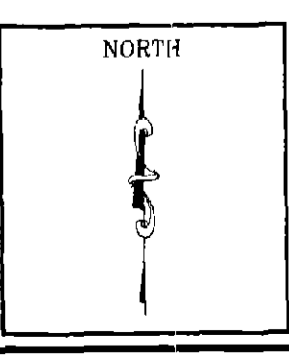

REMEDIAL INVESTIGATION CTO-0231
 MARINE CORPS BASE, CAMP LEJEUNE
 NORTH CAROLINA

BAKER ENVIRONMENTAL, Inc
 Coraopolis, Pennsylvania

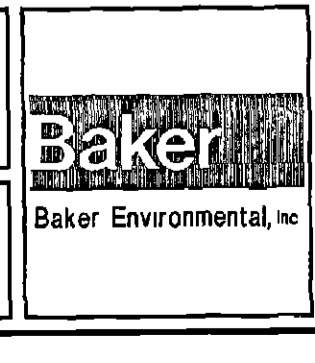

SITE MAP
 SITE 1 - FRENCH CREEK
 LIQUIDS DISPOSAL AREA

 SCALE 1" = 125'

DATE JANUARY 1995

FIGURE No
2-1

SOURCE LANTOIV, FEBRUARY 1992

01499UC5X

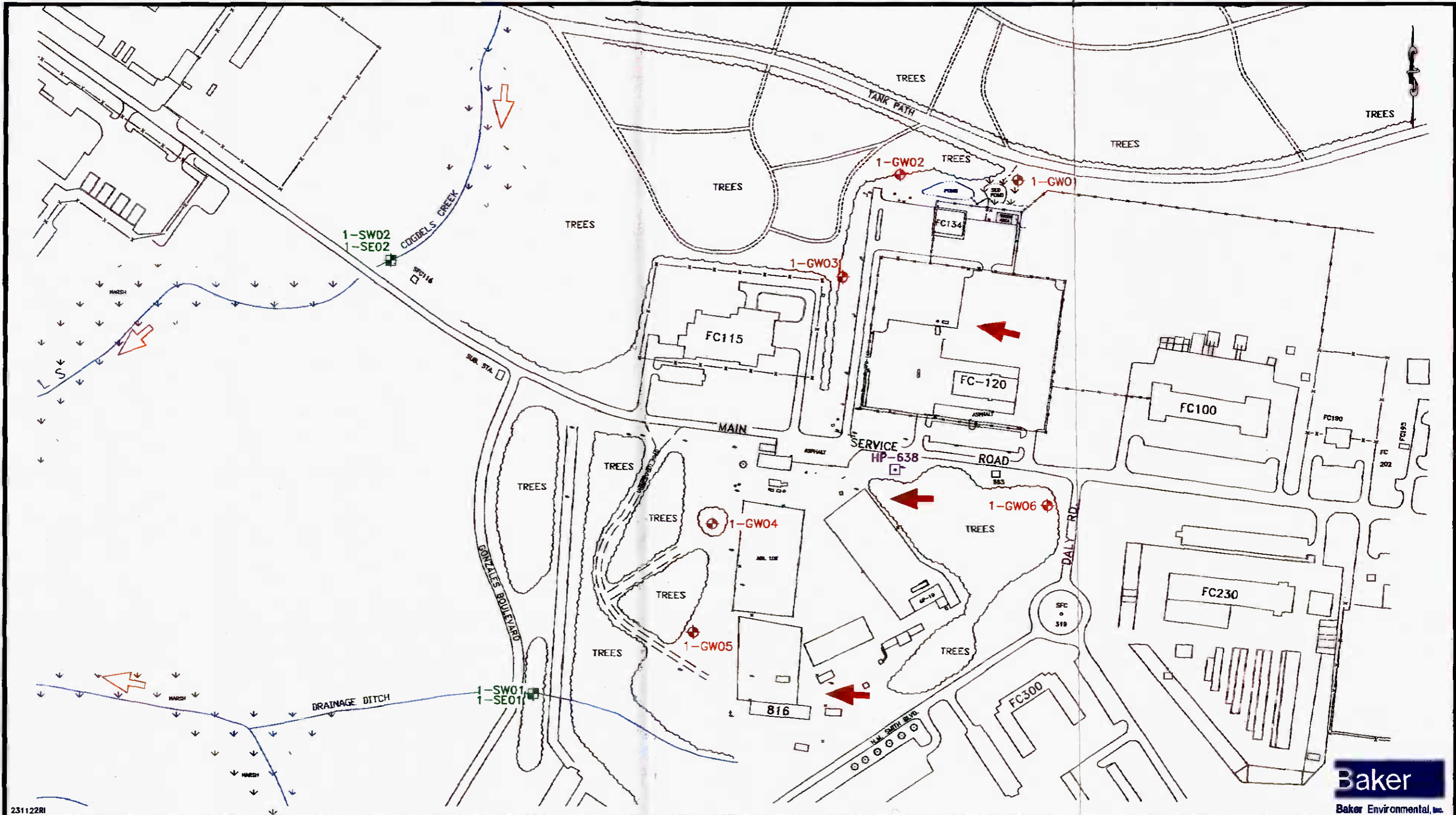

231122RI

LEGEND

- 1-GW01 SHALLOW MONITORING WELL (ESE, 1984)
- 1-SW02
1-SE02 SURFACE WATER AND SEDIMENT SAMPLING STATION (ESE, 1986)
- HP-638 WATER SUPPLY WELL
- ➔ APPROXIMATE GROUNDWATER FLOW DIRECTION
- ➔ APPROXIMATE SURFACE WATER FLOW DIRECTION

SOURCE: LANTDIV, FEBRUARY 1992, ESE, SEPTEMBER 1990, AND W.K. DICKSON & ASSOC., JUNE 1994

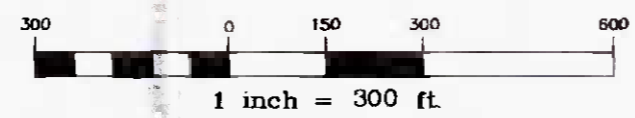

FIGURE 2-2
SAMPLING LOCATIONS
CONFIRMATION STUDY
SITE 1 - FRENCH CREEK LIQUIDS DISPOSAL AREA
REMEDIAL INVESTIGATION CTO-0231
MARINE CORPS BASE, CAMP LEJEUNE
NORTH CAROLINA

0149911064



1500 0 750 1500
1 inch = 1500 ft.

Baker
Baker Environmental, Inc.

FIGURE 2-3
AERIAL PHOTOGRAPH, OCTOBER 1949
AERIAL PHOTOGRAPHIC INVESTIGATION
SITE 1 - FRENCH CREEK LIQUIDS DISPOSAL AREA
REMEDIAL INVESTIGATION CTO-0231
MARINE CORPS BASE, CAMP LEJEUNE
NORTH CAROLINA

SOURCE: EPIC, 1992

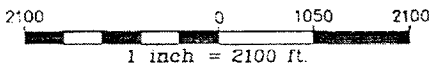

Baker
Baker Environmental, Inc.

FIGURE 2-4
AERIAL PHOTOGRAPH, NOVEMBER 1960
AERIAL PHOTOGRAPHIC INVESTIGATION
SITE 1 - FRENCH CREEK LIQUIDS DISPOSAL AREA
REMEDIAL INVESTIGATION CTO-0231
MARINE CORPS BASE, CAMP LEJEUNE
NORTH CAROLINA

SOURCE: EPIC, 1992



Baker
Baker Environmental, Inc.

FIGURE 2-5
AERIAL PHOTOGRAPH, JANUARY 1984
AERIAL PHOTOGRAPHIC INVESTIGATION
SITE 1 - FRENCH CREEK LIQUIDS DISPOSAL AREA
REMEDIAL INVESTIGATION CTO-0231
MARINE CORPS BASE, CAMP LEJEUNE
NORTH CAROLINA

3.0 STUDY AREA INVESTIGATION

This section discusses the site-specific RI field investigation activities that were conducted to fulfill the objectives identified in Section 2-4. The initial phase of the RI field investigation commenced on March 14, 1994, and continued through May 12, 1994. A second round of groundwater samples was collected in November of 1994. The RI field program at Site 1 consisted of a site survey; a soil investigation, which included drilling and sampling; and a groundwater investigation, which included monitoring well installation and sampling. Due to a lack of rainfall and the intermittent nature of surrounding drainages, a surface water and sediment investigation intended for Site 1 was not completed. The following section details the various investigation activities that were implemented during the RI.

3.1 Site Survey

The site survey task was performed in two phases: Phase I - Initial Survey of Site Features and Proposed Sampling Locations; and Phase II - Post Investigation Survey of Monitoring Wells. The firm of W. K. Dickson and Associates, Inc. was retained to perform both phases of the site survey. Phase I of the survey task was conducted at Site 1 during the week of March 14, 1994. Based upon information supplied in the Final Site Summary Report (ESE, 1990), surface features within and surrounding the suspected acid and POL disposal areas were surveyed. The proposed soil boring and monitoring well locations, provided in the Final RI/FS Work Plan for OU No.7 (Baker, 1993), were also surveyed and then marked with wooden stakes. Each sample location was assigned a unique identification number that corresponded to the site and sampling media.

Phase II of the site survey task was completed at Site 1 during the week of May 9, 1994. During Phase II, all existing and newly installed monitoring wells were surveyed at Site 1. In addition, any supplemental or relocated soil borings completed during the investigation were also surveyed. A number of soil borings were relocated (i.e., moved more than ten feet from their proposed location) due to the presence of either underground or overhead utilities. For each sampling point and monitoring well, the latitude, longitude, and elevation in feet above mean sea level (msl) were recorded. An account of all soil boring and monitoring well locations is provided in Sections 3.2.2 and 3.3.1, respectively.

3.2 Soil Investigation

The soil investigation performed at Site 1 was intended to assess the nature and extent of battery acid and POL contamination that may have resulted from previous disposal practices or site activities. Additionally, the soil investigation was performed to assess the human health, ecological, and environmental risks associated with exposure to surface and subsurface soils. The following subsections describe soil sample collection procedures and locations, as well as the analytical program for soils at Site 1.

3.2.1 Drilling Procedures

Drilling activities at Site 1 commenced on March 28, 1994, and continued through April 6, 1994. Environmental Monitoring and Testing Corporation (EMTC) was retained to perform the drilling services. Soil borings were advanced by a truck-mounted drill rig using 3-1/4-inch inside diameter (ID) hollow stem augers. Site 1 is covered primarily by paved (i.e., asphalt, concrete) or improved (i.e., coarse gravel) road surface, parking lots, and storage lots; as a result, certain site-specific

drilling practices were implemented. A dedicated lead auger was employed to cut through all asphalt overburden material, and a rotary air hammer was used to break through concrete. Once the overburden material had been removed, decontaminated augers were used to advance the borehole. Split-spoon samples were collected from inside the augers according to ASTM Method D 1586-84 (ASTM, 1984). All drilling and sampling activities conducted at Site 1 were performed using Level D personnel protection. Soil cuttings obtained during the drilling program were collected, handled, and stored according to the procedures outlined in Section 3.5.

Two types of borings were installed during the soil investigation: exploratory borings (i.e., borings installed for sample collection and lithologic description or lithologic description only) and borings advanced for monitoring well installation. Soil sampling intervals for the two types of borings differed only slightly, due to analytical requirements. Selected soil samples from each of the two types of borings were submitted for laboratory analysis (see Section 3.2.4). Soils obtained from exploratory borings were collected from the surface (i.e., ground surface to a depth of 12 inches) and then at continuous two-foot intervals, starting at one foot bgs. Drilling and continuous two-foot sample collection was terminated at the approximate depth of the water table, which varied at Site 1 from six to 25 feet bgs. An additional split-spoon was driven below the water table to confirm both groundwater depth and the absence of a wetting front (i.e., perched water table). Soil from borings advanced for monitoring well installations was also obtained from the ground surface and at continuous two-foot intervals to the water table. However, once drilling progressed below the water table, soil samples were collected at five-foot intervals until the pilot test boring was terminated. A summary of boring depths and sampling intervals for Site 1 is provided in Tables 3-1 through 3-3.

Each split-spoon soil sample was classified in the field by a geologist. Soils were classified using the Unified Soil Classification System (USCS) by the visual-manual methods described in ASTM D-2488. Lithologic descriptions were recorded in a field logbook and later transposed onto boring log records. Soil classification included characterization of soil type, grain size, color, moisture content, relative density, plasticity, and other pertinent information such as indications of contamination. Lithologic descriptions of site soils are provided on Test Boring Records in Appendix A and on Test Boring and Well Construction Records in Appendix B.

3.2.2 Soil Sampling Locations

Soil samples were collected throughout Site 1, as depicted on Figure 3-1. The sampling distribution was intended to evaluate the vertical and horizontal extent of contamination within the northern and southern disposal areas. The selection of sample locations was based on review of historical aerial photographs, Camp Lejeune historical records, and previous investigation data. Review of historical information indicated that the disposal of acid and POL wastes was suspected within three areas of the site (see Figure 2-1). Two of the suspected disposal areas, identified in the IAS report (WAR, 1983), are located adjacent to Building FC-120 north of Main Service Road. The remaining suspected disposal area is located to the south of Main Service Road and extends south toward H. M. Smith Boulevard (refer to Section 2.0, Site Background and Setting). Aerial photographs, taken periodically from 1940 to 1990, were employed to confirm information supplied in the IAS report.

A total of 54 borings were advanced to assess suspected disposal practices at Site 1. Eleven of those borings were converted to monitoring wells. As depicted on Figure 3-1, a total of 29 borings and monitoring well test borings were advanced within the northern portion of the study area. Twenty-five of the 54 boring locations were advanced within the southern portion of the site, including monitoring well test borings. In addition, soil borings 1-BB-SB38 and 1-BB-SB39 were completed

on the southern side of H.M. Smith Boulevard to assess background contaminant concentrations (refer to Figure 3-1).

3.2.3 Soil Sampling Procedures

Surface (i.e., ground surface to 12 inches bgs) and selected subsurface (i.e., greater than one foot bgs) soil samples were retained for laboratory analysis. Both surface and subsurface samples were collected to evaluate the nature and extent (both horizontal and vertical) of potentially impacted soils. Only the surface soils, however, were collected for human health and ecological risk assessment evaluation. A summary of boring numbers, depths, intervals, and analytical parameters for Site 1 soil samples is provided in Tables 3-1 through 3-3.

Soil samples were obtained via a drill rig (i.e., split-spoon samples) as described in the drilling procedures section. Surface samples were collected by slowly advancing the augers to approximately 12 inches bgs so that the soil cuttings could be retained. When the sampling location was covered with grass or humus material, the first inch of material was removed prior to advancing the augers. Surface soil grab samples were also collected, when conditions permitted, with a stainless steel spoon. Because asphalt, concrete, and gravel overburden material, only was present in many locations 14 surface samples were submitted for laboratory analysis. At those locations where overburden was present, the one to three foot sample was collected immediately below the material. Deeper subsurface grab samples were collected with a split-spoon sampler in accordance with ASTM Method D 1586-84. The augers, split-spoons samplers, and soil collection trowels were decontaminated prior to sample collection according to the procedures outlined in Section 3.4.

A minimum of two samples were retained for laboratory analysis from each of the boring locations. In some cases, a third sample from the borehole was also submitted for analysis if indications of contamination (i.e., elevated photoionization detector (PID) readings or visual contamination) were noted or if the water table was encountered greater than ten feet bgs. Soil samples retained for analysis were prepared and handled according to USEPA Region IV Standard Operating Procedures (SOPs). Samples collected for volatile organic analysis were extracted with a stainless-steel spoon from different sections of the split-spoon which represented the entire sampling interval. Precautions were taken not to aerate the sample so as to minimize volatilization. Samples retained for other analytical parameters (e.g., semivolatiles, pesticides, PCBs, and metals) were first thoroughly homogenized and then placed in the appropriate laboratory containers.

Following sample collection, each sample retained for laboratory analysis was stored on ice in a cooler. Sample preparation also included documentation of sample number, depth, location, date, time, and analytical parameters in a field logbook. Chain-of-Custody documentation, provided in Appendix D, accompanied the samples to the laboratory. Information such as sample number, date, time of sampling, and sampling personnel was included on these forms. Samples were shipped overnight via Federal Express to CEIMIC, Inc. for analysis.

3.2.4 Analytical Program

The analytical program initiated for the soil investigation at Site 1 focused on the suspected contaminants of concern, which were based on previous disposal practices. Soils collected from the former disposal area locations were analyzed for full TCL organics (i.e., volatiles, semivolatiles, pesticides, and PCBs) and TAL inorganics, and, in most cases TPH. Soil samples obtained from monitoring well test borings were analyzed for full TCL organics and TAL inorganics. A summary

of test boring numbers, depths, intervals, and analytical parameters for Site 1 is provided in Tables 3-1 through 3-3.

In addition to analyzing for the contaminants of concern, one test boring was advanced and soils were collected for analysis of engineering parameters (i.e., particle size, and Atterberg limits). Engineering parameter samples consisted of composites of individual grab samples collected from the ground surface to the water table. Note that the samples were prepared and handled as described in the previous section (i.e., samples were thoroughly homogenized before being placed in sample jars).

3.2.5 Quality Assurance and Quality Control

Field QA/QC samples were also collected during the soil investigation. These samples were obtained to: (1) ensure that decontamination procedures were properly implemented (e.g., equipment rinsate samples); (2) evaluate field methodologies (e.g., duplicate samples); (3) establish field background conditions (e.g., field blanks); and (4) evaluate whether cross-contamination occurred during sampling and/or shipping (e.g., trip blanks). Data Quality Objectives (DQOs) for the QA/QC samples were implemented in accordance with DQO Level IV as defined in the Environmental Compliance Branch SOPs and Quality Assurance Manual, USEPA Region IV (USEPA, 1991). This DQO Level is equivalent to Naval Energy and Environmental Support Agency (NEESA) DQO Level D, as specified in the "Sampling and Chemical Analysis Quality Assurance Requirements for the Navy Installation Restoration Programs" document (NEESA, 1988).

Four types of field QA/QC samples were collected and analyzed including: duplicate samples; equipment rinsates samples; field blanks; and trip blanks. These sampling definitions are listed below (USEPA, 1991):

- Duplicate Sample: Two or more samples collected simultaneously into separate containers from the same source under identical conditions.
- Equipment Blanks: Equipment field blanks (or rinsate blanks) are defined as samples which are obtained by running organic free water over/through sample collection equipment after it has been cleaned. These samples are used to determine if decontamination procedures were adequate. A minimum of one equipment blank per sample media was collected daily, however, only every other blank was analyzed.
- Field Blanks: Organic-free water is taken to the field in sealed containers and poured into the appropriate sample containers at designated locations. This is done to determine if contaminants present in the area may have an affect on the sample integrity. Field blanks should be collected in dusty environments and/or from areas where volatile organic contamination is present in the atmosphere and originating from a source other than the source being sampled.
- Trip Blanks: Trip blanks are prepared prior to the sampling event in the actual sample container and are kept with the investigative samples throughout the sampling event. They are then packaged for shipment with the other samples and sent for analysis. At no time after their preparation are the sample containers to be opened before they return to the laboratory. Field sampling teams utilize volatile

organic trip blanks to determine if samples were contaminated during storage and transportation back to the laboratory. If samples are to be shipped, trip blanks are to be provided for each shipment but not necessarily for each cooler (i.e., coolers with samples for VOC analysis only).

Table 3-4 summarizes field QA/QC sample types, sample frequencies, the number of QA/QC samples, and parameters analyzed. Field QA/QC samples were collected at Site 1 according to the procedures outlined in the USEPA Region IV SOPs.

3.2.6 Air Monitoring and Field Screening

Several air monitoring and field screening procedures were implemented during drilling and sampling activities for health and safety and initial contaminant monitoring. During drilling, ambient air monitoring in the vicinity of the borehole was performed with a PID to monitor for airborne contaminants. Moreover, samples (i.e., split-spoon samples) were screened with a PID to measure for volatile organic vapor. Measurements obtained in the field were recorded in a field logbook and later transposed onto the Test Boring Records and the Test Boring and Well Construction Records, which are provided in Appendices A and B, respectively. Prior to daily monitoring, the field instruments were calibrated and documentation was recorded in a field logbook and on calibration forms.

3.3 Groundwater Investigation

The groundwater investigations performed at OU No. 7, Site 1 were intended to assess the nature and extent of contamination that may have resulted from previous disposal practices or site activities. Additionally, the groundwater investigation was performed to assess human health, ecological, and environmental risks associated with exposure to groundwater. The following subsections describe well installation procedures, sample collection procedures, and the analytical program employed during the groundwater investigation at Site 1.

Two rounds of groundwater samples were collected at Site 1. Round One, which included sample collection from all existing and newly installed wells, was conducted in April and May of 1994 and was part of the original scope of work. Round Two groundwater sampling was performed in November of 1994 and included the resampling of the round one wells. Shallow well 1-GW14, however, was not resampled during the second round because the well contained less than one foot of water. The second round was conducted to confirm the presence or absence of contaminants, specifically metals and volatile organic compounds.

3.3.1 Monitoring Well Installation

Nine shallow Type II monitoring wells (i.e., wells installed without casing to seal off a confining layer) were installed at Site 1 between April 9, and April 19, 1994. Locations of the newly installed monitoring wells 1-GW07 through 1-GW13, 1-GW16, and 1-GW17 are depicted on Figure 3-2. The nine shallow monitoring wells were situated to collect potentially impacted groundwater from the suspected disposal areas, thus characterizing the nature and horizontal extent of contamination. They were also situated to evaluate the flow patterns of the surficial aquifer. In addition to the nine shallow wells, two deep Type II monitoring wells were installed at Site 1, as illustrated in Figure 3-2, between May 2, and May 7, 1994. The two deep monitoring wells were installed to characterize the nature and vertical extent of contamination. Placement of the newly installed

monitoring wells was based upon review of historical aerial photographs, Camp Lejeune records, and analytical data from previous investigations.

The shallow monitoring wells were installed upon completion of pilot hole test borings. Each borehole was overdrilled with 6-1/4-inch ID hollow stem augers during well installation. Well depths ranged from 17 to 31 feet bgs. In general, the shallow wells were installed approximately 10 feet below the water table encountered during the initial test boring. Shallow monitoring wells were installed at depths and with screen interception intervals sufficient to compensate for seasonal variations in the water table, which are known to fluctuate from 2 to 4 feet in elevation. Well construction details are summarized on Table 3-5. Well construction diagrams are shown on the Test Boring and Well Construction Records provided in Appendix B.

The deep monitoring wells (i.e., Type II wells) were installed upon completion of pilot hole test borings. Pilot hole test borings were advanced using the mud rotary drilling method and an 8-3/4-inch outside diameter (OD) roller bit. Due to the absence of a confining layer and the unconsolidated nature of the surficial soils, steel casing was employed at each deep well location to prevent the upper portion of the borehole from collapsing. Screened intervals were set in similar geologic material, from 105 to 122 feet bgs, that best represented the upper portion of the Castle Hayne aquifer. Well construction details are summarized on Table 3-5, and well construction diagrams are provided in Appendix C.

Both the shallow and deep wells were constructed of 2-inch nominal diameter Schedule 40, flush-joint and threaded, polyvinyl chloride (PVC) casing. Justification for the use of PVC casing is provided in Appendix B of the Field Sampling and Analysis Plan for Operable Unit No.7 (Baker, 1993a). Each well, upon completion, had a 15-foot screened interval comprised of a 10-foot and 5-foot long No. 10 (.01 inch) slotted screen. A fine-grained sand pack (No. 1 silica sand), extending approximately 2 feet above the top of the screen, was placed in the annulus between the screen and the borehole wall from inside the augers during shallow well installation. The sand pack was poured manually down the borehole during deep well installation. A two-to three-foot, sodium bentonite pellet seal was then placed, by dropping the pellets down the borehole, above the sand pack and hydrating with potable water (Note: A field blank of the potable water supply was retained for analysis). The seal was installed to prevent cement or surface run-off from intruding into the sand pack. The remaining annular space was backfilled up to the ground surface with a mixture of Portland cement and five percent bentonite. A four-inch protective casing with a protective cover was then placed over the well and set into the cement. In addition, a protective locking cap was installed at the top of the PVC well. A five-foot by five-foot concrete pad was constructed around the protective well casing and four protective bollard posts were installed around the corners of the concrete pad. Well tags, which provide construction information, were installed at the top of each well. Typical shallow and deep Type II well construction details are shown on Figures 3-3 and 3-4, respectively.

3.3.2 Monitoring Well Development

Following well construction and curing of the bentonite seal and grout, typically after a minimum of 48 hours, each newly installed monitoring well was developed to remove fine-grained sediment from the screen and to establish interconnection between the well and the surrounding formation. The shallow wells were developed by a combination of surging and pumping. The deep wells were developed by using a forced air system, with filter, and "air lifting" the water out of the well. Typically, 20 to 40 gallons of water were evacuated from the shallow wells, followed by 10 minutes

of surging, then continued pumping. Anywhere from 100 to 250 gallons of water, approximately 3 to 5 borehole volumes, were evacuated from the deep wells. Groundwater recovered during well development was temporarily stored in drums, then transferred into an on-site tanker (refer to Section 3.5 for IDW handling). Pumping hoses, constructed of flexible PVC, were used once and discarded to minimize the potential for cross contamination.

Three to five borehole volumes were removed from each well, where conditions permitted, until the groundwater was essentially sediment-free. Measurements of pH, specific conductance, and temperature were recorded at each volume to assist in determining well stabilization. Additionally, periodic flow and volume measurements were also recorded during development to estimate flow rates of the shallow water-bearing zone. Well Development Forms that summarize this information are provided in Appendix D.

3.3.3 Water Level Measurements

Static water level measurements were collected 48 hours after all well development and sampling activities had been completed. Measurements were recorded from top-of-casing (TOC) reference points, marked on the PVC casing at each existing and newly-installed well (refer to Section 4). A complete round of static water measurements was collected on May 9, 1994. Groundwater measurements were recorded using an electric measuring tape (i.e., M-scope). Measurements were recorded to the nearest 0.01 foot from TOC. Water level data were collected within a three-hour period.

3.3.4 Groundwater Sampling Locations

Round one groundwater samples were collected from seven existing shallow wells, the nine newly-installed shallow wells, a base water supply well (HP-638), and the two, newly-installed deep wells. During round two, groundwater samples were collected from all of the round one wells, with the exception of existing shallow well 1-GW14. A sample was not collected from existing well 1-GW05 during either round, the well had been damaged and rendered unusable. As a result, well 1-GW05 was abandoned according to procedures outlined in Section 3.3.9 during the groundwater investigation. The locations of the newly installed and existing wells are depicted on Figure 3-2.

3.3.5 Groundwater Sampling Procedures

Groundwater samples were collected to confirm the presence of contamination which may have resulted from previous site disposal practices in both the shallow and deep aquifers. At Site 1, the contaminants of concern were POL and acid waste liquids, based on previous investigative results and historical records. Accordingly, the sampling program initiated at Site 1 focused on these contaminants.

Prior to groundwater purging, a water level measurement from each well was obtained according to procedures outlined in Section 3.3.3. The total well depth was also recorded from each well to the nearest 0.1 foot using a decontaminated steel tape. Water level and well depth measurements were used to calculate the volume of water in each well and the volume of water necessary to purge the well.

A minimum of three to five well volumes were purged from each well prior to sampling. Measurements of pH, specific conductance, and temperature were taken after each well volume was

purged to ensure that the groundwater characteristics had stabilized before sampling. In addition, turbidity was also measured during round two. These measurements were recorded in a field logbook and are provided in Table 3-6. Purge water was contained and handled as described in Section 3.5.

Round one groundwater samples were collected using decontaminated teflon bailers (i.e., bottom loading bailer). A single teflon bailer was employed to both sample and purge groundwater from each of the wells. The samples were introduced directly from the bailer into laboratory-prepared sample containers and stored on ice. Sample bottles for VOC analysis were filled first, followed by SVOCs, pesticides, PCBs, and TAL metals (total and dissolved). Volatile samples were collected by slowly pouring water from the bailer into 40 ml vials to minimize volatilization. Samples analyzed for dissolved metals were filtered in the field and sent in containers with nitric acid (HNO₃) preservative. The dissolved groundwater samples were filtered through a disposable 0.45 micron membrane using a peristaltic pump.

Analytical results from the first round of sampling exhibited total metal concentrations frequently in excess of state and federal groundwater standards. These elevated metal detections were primarily due to an abundance of total suspended solids, or colloids, in samples collected during the first round. Metals adhere to these colloids, thus yielding artificially high concentrations. The use of a bailer during sample acquisition tends to increase the percentage of colloids. Through agitation, colloids can move from the formation and through the sand pack into the well, and subsequently impact the sample. As a result, data from the first round of sampling reflect the presence of colloids rather than true groundwater conditions. The purpose of the second sampling round was to minimize sample disturbance, thus reducing the occurrence of colloids. The second round of groundwater data more accurately depicts actual groundwater conditions at Site 1.

During the round two sampling event, a low flow well purging and sampling technique was employed. The sampling methodology was developed in response to conversations with USEPA Region IV personnel in Athens, Georgia. A submersible pump (Redi-Flow 2), set two to three feet into the static water column, was used to purge each of the wells. While purging groundwater from each of the monitoring wells, a flow rate of less than one gpm was maintained. Samples collected for both organic and metal analyses were obtained directly from the pump discharge. The pump and associated tubing were decontaminated with a Liquinox soap solution and then thoroughly rinsed with deionized water (refer to Section 3.4 for decontamination procedures). Rinsate blanks were collected from the pump to verify that proper decontamination procedures were implemented.

The supply well, HP-638, was also sampled according to USEPA Region IV procedures as part of the groundwater investigation. Approximately two well volumes were purged from the inactive well using a diesel-powered emergency generator. An estimation of pumping capacity was used to calculate the total time required to purge the well of approximately two volumes. As with monitoring wells, measurements of pH, specific conductance, and temperature were recorded during the purge process. The pumping rate was reduced during sample collection.

Preparation of groundwater samples incorporated similar procedures as those described for soil samples. Sample information, including well number, sample identification, time and date of sample collection, samplers, analytical parameters, and required laboratory turnaround time was recorded in a field logbook and on the sample labels. Chain-of-custody documentation (provided in Appendix C) accompanied the samples to the laboratory.

3.3.6 Analytical Program

Round one groundwater samples were analyzed for the following: volatiles, semivolatiles, and TAL metals (total and dissolved). Groundwater samples from wells 1-GW04, 1-GW11, 1-GW16, 1-GW17, and HP-638 also were submitted for pesticide and PCB analyses. During round two, all groundwater samples were analyzed for TAL metals (total dissolved), TSS, and TDS; moreover, a limited number of groundwater samples were also analyzed for TCL volatiles and semivolatiles. Table 3-7 provides a summary of groundwater samples submitted for laboratory analysis. The groundwater samples were analyzed using Contract Laboratory Program (CLP) protocols and Level IV data quality.

In addition to analyzing for the contaminants of concern, one groundwater sample from shallow well 1-GW17 was submitted for analysis of water chemistry parameters. Water chemistry parameters included: total dissolved solids, total suspended solids, fluorine, chlorine, nitrogen, biological oxygen demand, chemical oxygen demand, and alkalinity.

3.3.7 Quality Assurance and Quality Control

Field QA/QC samples were also submitted for analysis during the groundwater investigation. These samples included trip blanks, equipment rinsates, and duplicates. Equipment rinsates were collected from the sampling bailers prior to usage. Table 3-8 summarizes the QA/QC sampling program employed for the groundwater investigation conducted at Site 1.

3.3.8 Field Screening and Air Monitoring

Several air monitoring and field screening procedures were implemented during the groundwater sampling activities for health and safety and initial contaminant monitoring. Air monitoring and field screening procedures implemented at Site 1 included the screening of well heads and the purged groundwater with a PID for volatile organic vapors. Measurements obtained in the field were recorded in a field logbook. Prior to daily monitoring, the field instruments were calibrated and documentation was recorded in a field logbook and on calibration forms.

3.3.9 Well Abandonment

The objective of well abandonment activities at Site 1 was to remove an existing well, 1-GW05, so that the borehole would not act as a conduit for migration of contaminants from the ground surface to the water table or between aquifers. This objective was accomplished during the RI by removing the well casing, well screen, and filter pack materials and then backfilling the borehole with a mixture of Portland cement and five percent bentonite, as specified by USEPA Region IV procedures. Hollow stem augers were employed to clean the borehole and remove filter pack materials. Backfill material was placed into the borehole from the bottom to the top using the positive displacement method (i.e., tremie method). The concrete pad and protective bollard posts were also removed. Finally, the ground surface was graded and returned to near-original conditions.

3.4 Decontamination Procedures

Decontamination procedures performed in the field were initiated in accordance with USEPA Region IV SOPs. Sampling and drilling equipment were divided into two decontamination groups, heavy equipment and routine sample collection equipment. Heavy equipment included the drill rig,

hollow-stem augers, drill, and sampling rods. Routine sample collection equipment included split spoons, stainless steel spoons and bowls, and teflon bailers.

For heavy equipment, the following procedures were implemented:

- Removal of caked-on soil with brush
- Steam clean with high-pressure steam
- Air dry

For routine sample collection equipment, the following procedures were implemented:

- Clean with distilled water and laboratory detergent (Liquinox soap solution)
- Rinse thoroughly with distilled water
- Rinse twice with isopropyl alcohol
- Air dry
- Wrap in aluminum foil, if appropriate

Temporary decontamination pads, constructed of wood and plastic, were constructed to minimize spillage onto the ground surface. Decontamination fluids generated during the field program were containerized and handled according to the procedures outlined in Section 3.6.

3.5 Investigation Derived Waste (IDW) Handling

Field investigation activities at Site 1 resulted in the generation of various IDW. This IDW included drilling mud, soil cuttings, well development and purge water, and solutions used to decontaminate non-disposable sampling equipment. The general management techniques utilized for the IDW were

1. Collection and containerization of IDW material (i.e., drill cuttings, purge water, decontamination fluids).
2. Temporary storage of IDW while awaiting confirmatory analytical data.
3. Final disposal of aqueous and solid IDW material.

IDW management was performed in accordance with guidelines developed by the USEPA Office of Emergency and Remedial Response, Hazardous Site Control Division.

Both non-contaminated and contaminated wastewater were sent off site to a licensed hazardous waste disposal facility. IDW soils were not contaminated based on the results of IDW soil samples. Therefore, the IDW soils were disposed of at their respective source areas. Appendix E provides information regarding the sampling, management, and disposal of the IDW.

SECTION 3.0 TABLES

TABLE 3-1

**SOIL SAMPLING SUMMARY
TEST BORINGS
SITE 1, FRENCHS CREEK LIQUIDS DISPOSAL AREA (SOUTH)
REMEDIAL INVESTIGATION, CTO-0231
MCB, CAMP LEJEUNE, NORTH CAROLINA**

Sample Location	Depth of Borehole (feet, bgs)	Sampling Interval (feet, bgs)	Analytical Parameters							
			TCL Organics	TAL Metals	TPH	TCL VOC	TCL SVOC	TCLP	Engineering Parameters ⁽¹⁾	Duplicate Sample
1-1S-SB01	19	1-3	X	X	X					
		7-9	X	X						
		15-17	X	X	X					
1-1S-SB02	17	1-3	X	X	X					
		7-9	X	X	X					
		13-15	X	X	X					
1-1S-SB03	17	1-3	X	X	X					
		5-7	X	X	X					
		11-13	X	X	X					
1-1S-SB04	15	1-3	X	X	X					
		7-9	X	X	X					
		11-13	X	X	X					
1-1S-SB05	15	1-3	X	X	X					
		7-9	X	X	X					
		15-17	X	X	X					
1-1S-SB06	21	1-3	X	X	X					
		7-9	X	X	X					
		15-17	X	X	X					
1-1S-SB07	17	1-3	X	X	X					
		7-9	X	X	X					
		13-15	X	X	X					
1-1S-SB08	15	1-3	X	X	X					X
		7-9	X	X	X					
		13-15	X	X	X					
1-1S-SB09	17	1-3	X	X	X					
		7-9	X	X	X					
		13-15	X	X	X					
1-1S-SB10	19	1-3	X	X	X					
		7-9	X	X	X					
		15-17	X	X	X					
1-1S-SB11	15	1-3	X	X	X					
		5-7	X	X	X					
		11-13	X	X	X					

Notes: ⁽¹⁾ Engineering parameters include full TCLP, RCRA hazardous waste characteristics, grain size, and Atterberg limits.
⁽²⁾ Background or control sample location.

TABLE 3-1 (Continued)

SOIL SAMPLING SUMMARY
 TEST BORINGS
 SITE 1, FRENCH CREEK LIQUIDS DISPOSAL AREA (SOUTH)
 REMEDIAL INVESTIGATION, CTO-0231
 MCB, CAMP LEJEUNE, NORTH CAROLINA

Sample Location	Depth of Borehole (feet, bgs)	Sampling Interval (feet, bgs)	Analytical Parameters							
			TCL Organics	TAL Metals	TPH	TCL VOC	TCL SVOC	TCLP	Engineering Parameters ⁽¹⁾	Duplicate Sample
1-1S-SB12	15	1-3	X	X	X					
		7-9	X	X	X					
		13-15	X	X	X					
1-1S-SB13	17	1-3	X	X	X					
		7-9	X	X	X					
		13-15	X	X	X					
1-1S-SB14	15	1-3	X	X	X					X
		5-7	X	X	X					X
		11-13	X	X	X					
1-1S-SB15	15	1-3	X	X	X					
		7-9	X	X	X					
		13-15	X	X	X					
1-1S-SB16	17	1-3	X	X	X					
		7-9	X	X	X					
		15-17	X	X	X					
1-1S-SB17	15	1-3	X	X	X					
		7-9	X	X	X					
		13-15	X	X	X					
1-1S-SB18	17	1-3	X	X	X					
		5-7	X	X	X					
		11-13	X	X	X					
1-1S-SB38 ⁽²⁾	13	0-1.0	X	X						
		9-11	X	X						
1-1S-SB39 ⁽²⁾	15	0-1.0	X	X						
		7-9	X	X						
		11-13	X	X						
1-1S-SB40	15	0-15/ composite						X	X	

Notes: ⁽¹⁾ Engineering parameters include full TCLP, RCRA hazardous waste characteristics, grain size, and Atterberg limits.
⁽²⁾ Background or control sample location.

TABLE 3-2

**SOIL SAMPLING SUMMARY
TEST BORINGS
SITE 1, FRENCHS CREEK LIQUIDS DISPOSAL AREA (NORTH)
REMEDIAL INVESTIGATION, CTO-0231
MCB, CAMP LEJEUNE, NORTH CAROLINA**

Sample Location	Depth of Borehole (feet, bgs)	Sampling Interval (feet, bgs)	Analytical Parameters							
			TCL Organics	TAL Metals	TPH	TCL VOC	TCL SVOC	TCLP	Engineering Parameters ⁽¹⁾	Duplicate Sample
1-1N-SB19	13	0-1.0	X	X	X					
		7-9	X	X	X					
1-1N-SB20	13	0-1.0	X	X	X					
		9-11	X	X	X					
1-1N-SB21	17	1-3	X	X	X					
		7-9	X	X	X					
		13-15	X	X	X					
1-1N-SB22	19	1-3	X	X	X					X
		11-13	X	X	X					X
		15-17	X	X	X					
1-1N-SB23	19	1-3	X	X	X					
		7-9	X	X	X					
		13-15	X	X	X					
1-1N-SB24	17	1-3	X	X	X					
		7-9	X	X	X					
		13-15	X	X	X					
1-1N-SB25	15	1-3	X	X	X					
		11-13	X	X	X					
1-1N-SB26	11	1-3	X	X	X					X
		7-9	X	X	X					X
1-1N-SB27	13	1-3	X	X	X					
		9-11	X	X	X					
1-1N-SB28	11	1-3	X	X	X					
		7-9	X	X	X					
1-1N-SB29	9	0-1.0	X	X	X					
		3-5	X	X	X					
1-1N-SB30	11	0-1.0	X	X	X					
		5-7	X	X	X					
1-1N-SB31	11	1-3	X	X	X					
		7-9	X	X	X					
1-1N-SB32	17	1-3	X	X	X					
		7-9	X	X	X					
		13-15	X	X	X					

Notes: ⁽¹⁾ Engineering parameters include full TCLP, RCRA hazardous waste characteristics, grain size, and Atterberg limits.

⁽²⁾ Background or control sample location.

TABLE 3-2 (Continued)

**SOIL SAMPLING SUMMARY
TEST BORINGS
SITE 1, FRENCH CREEK LIQUIDS DISPOSAL AREA (NORTH)
REMEDIAL INVESTIGATION, CTO-0231
MCB, CAMP LEJEUNE, NORTH CAROLINA**

Sample Location	Depth of Borehole (feet, bgs)	Sampling Interval (feet, bgs)	Analytical Parameters							
			TCL Organics	TAL Metals	TPH	TCL VOC	TCL SVOC	TCLP	Engineering Parameters ⁽¹⁾	Duplicate Sample
1-1N-SB33	17	1-3	X	X	X					
		7-9	X	X	X					
		13-15	X	X	X					
1-1N-SB34	17	1.5-3	X	X	X					
		5-7	X	X	X					
		13-15	X	X	X					
1-1N-SB35	15	1-3	X	X	X					
		11-13	X	X	X					
1-1N-SB36	15	1-3	X	X	X					
		11-13	X	X	X					
1-1N-SB37	7	1-3	X	X	X					
		3-5	X	X	X					

- Notes: ⁽¹⁾ Engineering parameters include full TCLP, RCRA hazardous waste characteristics, grain size, and Atterberg limits.
⁽²⁾ Background or control sample location.

TABLE 3-3

**SOIL SAMPLING SUMMARY
MONITORING WELL TEST BORINGS
SITE 1, FRENCHS CREEK LIQUIDS DISPOSAL AREA
REMEDIAL INVESTIGATION, CTO-0231
MCB, CAMP LEJEUNE, NORTH CAROLINA**

Sample Location	Depth of Borehole (feet, bgs)	Sampling Interval (feet, bgs)	Analytical Parameters								
			TCL Organics	TAL Metals	TPH	TCL VOC	TCL SVOC	TCLP	Engineering Parameters ⁽¹⁾	Duplicate Sample	
1-GW07	25	0-1.0	X	X	X						
		5-7	X	X	X						
		11-13	X	X	X						
1-GW08	25	0-1.0	X	X	X						
		5-7	X	X	X						
		11-13	X	X	X						
1-GW09	21	0-1.0	X	X	X						
		5-7	X	X	X						
1-GW10	24	0-1.0	X	X	X						
		5-7	X	X	X						
		11-13	X	X	X						
1-GW11	17	0-1.0	X	X	X						
		1-3	X	X	X						
1-GW12 ⁽²⁾	18	0-1.0	X	X	X						
		1-3	X	X	X						
1-GW13 ⁽²⁾	33	0-1.0	X	X	X						
		7-9	X	X	X						
		15-17	X	X	X						
1-GW16	27	1-3	X	X	X						X
		7-9	X	X	X						
		11-13	X	X	X						
1-GW16DW	122	0-1.0	X	X	X						
		7-9	X	X	X						
		13-15	X	X	X						
1-GW17	25	0-1.0	X	X	X						X
		9-11	X	X	X						X
1-GW17DW	122	0-1.0	X	X	X						
		9-11	X	X	X						

Notes: ⁽¹⁾ Engineering parameters include full TCLP, RCRA hazardous waste characteristics, grain size, and Atterberg limits.

⁽²⁾ Background or control sample location.

TABLE 3-4

QUALITY ASSURANCE/QUALITY CONTROL SAMPLING PROGRAM
 SOIL INVESTIGATION
 SITE 1, FRENCH CREEK LIQUIDS DISPOSAL AREA
 REMEDIAL INVESTIGATION, CTO-0231
 MCB, CAMP LEJEUNE, NORTH CAROLINA

QA/QC Sample ⁽¹⁾	Frequency of Collection	Number of Samples	Analytical Parameters
Trip Blanks ⁽²⁾	One per cooler	14	TCL Volatiles
Field Blanks ⁽³⁾	One per event	1	TCL Organics/TAL Metals
Equipment Rinsates ⁽⁴⁾	One per day	9	TCL Organics/TAL Metals
Field Duplicates ⁽⁶⁾	10% of sample frequency	10	TCL Organics/TAL Metals

- Notes: (1) QA/QC sample types defined in Section 3.2.5 in text.
 (2) Trip blanks submitted with coolers which contained samples for volatile analysis. Samples analyzed for TCL Volatiles only.
 (3) Field blank collected at Site 1 was the source water used for decontamination.
 (4) Equipment rinsates collected from various sampling equipment (e.g., stainless steel spoons).
 (5) Field duplicate samples presented in Appendix F.

TABLE 3-5

**SUMMARY OF WELL CONSTRUCTION DETAILS
SITE 1, FRENCH CREEK LIQUIDS DISPOSAL AREA
REMEDIAL INVESTIGATION, CTO-0231
MCB, CAMP LEJEUNE, NORTH CAROLINA**

Well No.	Date Installed	Top of PVC Casing Elevation (feet, above msl) ⁽¹⁾	Ground Surface Elevation (feet, above msl)	Boring Depth (feet, below ground surface)	Well Depth (feet, below ground surface)	Screen Interval Depth (feet, below ground surface)	Sand Pack Interval Depth (feet, below ground surface)	Bentonite Interval Depth (feet, below ground surface)
1-GW07	4/12/94	23.12	20.2	26	25	10-24.6	8-26	6-8
1-GW08	4/12/94	22.31	19.4	25	25	10.1-24.3	8-25	6-8
1-GW09	4/10/94	17.62	14.9	21	21	6.1-20.4	4-21	2-4
1-GW10	4/11/94	18.07	15.3	24	24	9.1-23.4	7-24	5-7
1-GW11	4/10/94	13.18	10.4	17	17	2-16.4	1-17	0.5-1
1-GW12	4/10/94	16.33	13.8	17	17	3.1-17.3	2-17	0.5-1.5
1-GW13	4/9/94	32.33	29.5	32	31	16-30.3	14-32	12-14
1-GW16	4/13/94	23/71	20.7	27	27	12-26.3	10-27	8-10
1-GW17	4/19/94	23.00	20.1	25	25	10-24.3	8-25	6-8
1-GW16DW	5/2-4/94	23.50	20.8	122	122	107-122	103-122	99-103
1-GW17DW	5/5-7/94	21.91	19.1	122	122	105-120	97-122	92-97

Notes: ⁽¹⁾ msl = mean sea level

Horizontal positions are referenced to N.C. State Plane Coordinate System (NAD 27) CF = 0.9999216 from USMC Monument Toney.

Vertical datum NGVD 29.

TABLE 3-6

**SUMMARY OF GROUNDWATER FIELD PARAMETERS
SITE 1, FRENCH CREEK LIQUIDS DISPOSAL AREA
REMEDIAL INVESTIGATION, CTO-0231
MCB, CAMP LEJEUNE, NORTH CAROLINA**

Well No.	Depth of Well (ft.) ⁽¹⁾	Purge Volume (gals.)	Field Parameters				
			Well Volume	Specific Conductance at 25°C (micromhos/cm)	Temperature (°C)	pH ⁽³⁾ (S.U.)	Turbidity ⁽⁴⁾ (T.U.)
1-GW01	24.25	2.55	3	480	18	6.86	NA
4-22-94			4	480	18	6.9	NA
			5	470	18	6.86	NA
11-12-94		2.55	8	400	21.1	6.82	93
			9	400	21.1	6.84	66
			10	400	21.1	6.83	56
1-GW01 ⁽²⁾	16.52	5.64	NA	490	17	8.63	NA
TEMP			NA	520	18	8.74	NA
			NA	530	18	9.09	NA
1-GW02	23.72	2.12	3	690	19	7.02	NA
4-22-94			4	670	19	6.77	NA
			5	660	19	6.93	NA
11-12-94		2.09	6	600	21	6.46	14
			7	600	21	6.53	13
			8	600	20.8	6.54	11
1-GW03	26.9	2.09	3	280	18	6.11	NA
4-22-94			4	250	18	6.02	NA
			5	220	18	6	NA
11-12-94		1.92	9	178	21.1	5.70	12
			10	179	22.1	5.68	10
			11	180	20.3	5.77	5
1-GW04	31.13	2.1	3	150	19	4.91	NA
4-24-94			4	160	19	5.3	NA
			5	180	19	5.94	NA
11-14-94		2.02	6	225	19.0	5.99	37
			7	239	18.6	5.87	31
			8	247	18.9	5.91	30
1-GW06	29.56	1.94	3	80	16	5.6	NA
4-23-94			4	80	16	5.43	NA
			5	70	16	5.68	NA
11-13-94		1.94	8	71	20.3	4.82	18
			9	70	20.4	5.20	15
			10	70	20.5	5.17	18

TABLE 3-6 (Continued)

SUMMARY OF GROUNDWATER FIELD PARAMETERS
 SITE 1, FRENCH CREEK LIQUIDS DISPOSAL AREA
 REMEDIAL INVESTIGATION, CTO-0231
 MCB, CAMP LEJEUNE, NORTH CAROLINA

Well No.	Depth of Well (ft.) ⁽¹⁾	Purge Volume (gals.)	Field Parameters				
			Well Volume	Specific Conductance at 25°C (micromhos/cm)	Temperature (°C)	pH ⁽³⁾ (S.U.)	Turbidity ⁽⁴⁾ (T.U.)
1-GW07	27.74	1.82	8	100	20	5.04	NA
4-24-94			9	110	20	5.05	NA
			10	120	20	5.22	NA
11-14-94		1.4	11	29	26.4	5.76	12
			12	29	27.7	5.16	12
			13	29	28.0	5.14	12
1-GW08	27.6	1.75	3	150	19	5.69	NA
4-24-94			4	160	18	5.72	NA
			5	160	19	5.78	NA
11-13-94		1.24	12	140	20.8	5.78	52
			13	NA	NA	NA	NA
			14	141	20.7	5.80	38
			15	141	20.8	5.80	28
1-GW09	23.5	1.84	4	120	18	7.47	NA
4-24-94			5	130	18	7.55	NA
			6	140	19	7.28	NA
11-13-94		1.93	9	130	19.9	6.34	39
			10	135	19.8	6.37	40
			11	140	19.6	6.41	35
1-GW10	27.9	2.54	3	570	17	6.84	NA
4-24-94			4	570	17	6.72	NA
			5	580	17	6.84	NA
11-11-94		2.45	5	500	18.2	7.09	9.4
			6	490	14.2	6.93	4.3
			7	500	17.0	6.84	3.1
1-GW11	19.7	2.19	3	600	15	6.68	NA
4-24-94			4	600	15	6.53	NA
			5	590	15	6.69	NA
11-12-94		2.24	7	400	18.1	6.85	6.4
			8	400	18.4	6.86	6.2
			9	400	18.4	6.87	4.6

TABLE 3-6 (Continued)

**SUMMARY OF GROUNDWATER FIELD PARAMETERS
SITE 1, FRENCH CREEK LIQUIDS DISPOSAL AREA
REMEDIAL INVESTIGATION, CTO-0231
MCB, CAMP LEJEUNE, NORTH CAROLINA**

Well No.	Depth of Well (ft.) ⁽¹⁾	Purge Volume (gals.)	Field Parameters				
			Well Volume	Specific Conductance at 25°C (micromhos/cm)	Temperature (°C)	pH ⁽³⁾ (S.U.)	Turbidity ⁽⁴⁾ (T.U.)
1-GW12	20.96	2.14	3	170	15	5.59	NA
4-24-94			4	160	15	5.48	NA
			5	160	15	5.64	NA
11-12-94		2.17	9	200	17.9	5.87	>100
			10	192	18.4	5.88	>100
			11	191	17.7	5.87	>100
1-GW13	33.67	2.22	3	50	19	5.3	NA
4-23-94			4	60	20	4.88	NA
			5	60	20	5.2	NA
11-13-94		2.24	10	60	22.0	4.95	38
			11	60	21.8	4.92	26
			12	60	21.8	4.71	23
1-GW14 ⁽²⁾	19.24	0.54	3	80	22	4.84	NA
4-24-94			4	90	22	4.79	NA
			5	80	22	4.79	NA
1-GW15	15.7	1.05	3	620	17	6.71	NA
4-23-94			4	620	17	6.5	NA
			5	620	17	6.54	NA
11-12-94		1.06	7	590	21.3	6.71	11
			8	590	21.6	6.72	7.1
			9	505	21.1	6.73	5
1-GW16	29.78	2.07	3	240	18	5.18	NA
4-24-94			4	250	18	5.34	NA
			5	260	18	5.27	NA
11-14-94		1.5	9	200	21.7	5.6	16
			10	200	21.8	5.63	15
			11	192	21.7	5.63	11
1-GW16DW	122	18.18	1	220	19	9.65	NA
5-9-94			2	220	19	9.26	NA
			3	210	20	9.1	NA
11-14-94 ⁽⁵⁾		17.78	1	189	20.2	4.04	9.1
			2	186	20.4	8.35	4.0
			3	194	20.1	1.18	3.2

TABLE 3-6 (Continued)

SUMMARY OF GROUNDWATER FIELD PARAMETERS
 SITE 1, FRENCH CREEK LIQUIDS DISPOSAL AREA
 REMEDIAL INVESTIGATION, CTO-0231
 MCB, CAMP LEJEUNE, NORTH CAROLINA

Well No.	Depth of Well (ft.) ⁽¹⁾	Purge Volume (gals.)	Field Parameters				
			Well Volume	Specific Conductance at 25°C (micromhos/cm)	Temperature (°C)	pH ⁽³⁾ (S.U.)	Turbidity ⁽⁴⁾ (T.U.)
1-GW17	27.71	2.1	3	570	21	6.61	NA
4-24-94			4	550	20	6.72	NA
			5	560	20	6.71	NA
11-16-94		1.6	6	505	85.6	7.03	23
			6.5	510	87.9	7.02	9.5
			7	NA	88.1	7.06	NA
1-GW17DW	125	19	2	160	23	10.31	NA
5-25-94			3	160	22	10.1	NA
			4	160	22	9.95	NA
11-16-94		18	1	150	20.6	8.81	5.5
			1.5	161	19.5	8.78	7.6
			2	163	19.7	9.17	4.8
1-HP638	196	19	2	250	20	8.6	NA
4-11-94			3	260	20	7.97	NA
			4	260	20	8.1	NA
11-11-94		20	2	202	16.7	7.09	6.6
			3	221	17.6	7.53	2.4
			4	221	18.1	7.55	1.3

Notes: NA - Not Available

(1) Well depth taken from top of casing (TOC)

(2) Round one samples collected only

(3) S.U. - Standard Units

(4) T.U. - Turbidity Units

(5) pH meter malfunctioned while purging 1-GW16DW

TABLE 3-7

GROUNDWATER SAMPLING SUMMARY
 SITE 1, FRENCH CREEK LIQUIDS DISPOSAL AREA
 REMEDIAL INVESTIGATION, CTO-0231
 MCB, CAMP LEJEUNE, NORTH CAROLINA

Sample Location	Analytical Parameters						
	TCL VOC	TCL SVOC	TCL Pest./ PCB	TAL Metals	Dissolved TAL Metals	Water Chemistry Parameters ⁽¹⁾	Duplicate Sample
1-GW01	X	X		X●	X●	●	
1-GW02	X	X		X●	X●	●	
1-GW03	X	X		X●	X●	●	
1-GW04	X	X	X	X●	X●	●	X
1-GW06	X	X		X●	X●	●	
1-GW07	X	X		X●	X●	●	●
1-GW08	X	X		X●	X●	●	
1-GW09	X	X		X●	X●	●	
1-GW10	X●	X		X●	X●	●	
1-GW11	X●	X	X	X●	X●	●	●
1-GW12	X●	X		X●	X●	●	
1-GW13 ⁽²⁾	X	X		X●	X●	●	
1-GW14 ⁽³⁾	X	X		X	X		
1-GW15	X	X		X●	X●	●	
1-GW16	X	X	X	X●	X●	●	
1-GW16DW	X	X		X●	X●	●	
1-GW17	X●	X	X	X●	X●	X●	
1-GW17DW	X	X●		X●	X●	●	
HP-638	X	X	X	X●	X●	●	

Notes: ⁽¹⁾ Water chemistry parameters include chemical oxygen demand, biological oxygen demand, total suspended solids (TSS), total dissolved solids (TDS), chloride, fluoride, alkalinity, and total Kjeldahl nitrogen. For round two, water chemistry parameters only included TSS and TDS.

⁽²⁾ Upgradient sample location.

⁽³⁾ Round two samples were not collected.

X - Indicates round one analyses

● - Indicates round two analyses

TABLE 3-8

**QUALITY ASSURANCE/QUALITY CONTROL SAMPLING PROGRAM
GROUNDWATER INVESTIGATION
SITE 1, FRENCH CREEK LIQUIDS DISPOSAL AREA
REMEDIAL INVESTIGATION, CTO-0231
MCB, CAMP LEJEUNE, NORTH CAROLINA**

QA/QC Sample ⁽¹⁾	Frequency of Collection	Number of Samples	Analytical Parameters
Trip Blanks ⁽²⁾	One per cooler	6	TCL Volatiles
Field Blanks ⁽³⁾	One per event	1	TCL Organics/TAL Metals
Equipment Rinsates ⁽⁴⁾	One per day	6	TCL Organics/TAL Metals
Field Duplicates ⁽⁵⁾	10% of sample frequency	5	TCL Organics/TAL Metals

- Notes: ⁽¹⁾ QA/QC sample types defined in Section 3.2.5 in text. Includes both round one and two samples.
- ⁽²⁾ Trip blanks submitted with coolers which contained samples for volatile analysis. Samples analyzed for TCL Volatiles only.
- ⁽³⁾ Field blank collected during the round two groundwater investigation from water source used for decontamination.
- ⁽⁴⁾ Equipment rinsates collected from various sampling equipment (e.g., bailer and pump).
- ⁽⁵⁾ Field duplicate samples presented in Appendix F.

SECTION 3.0 FIGURES

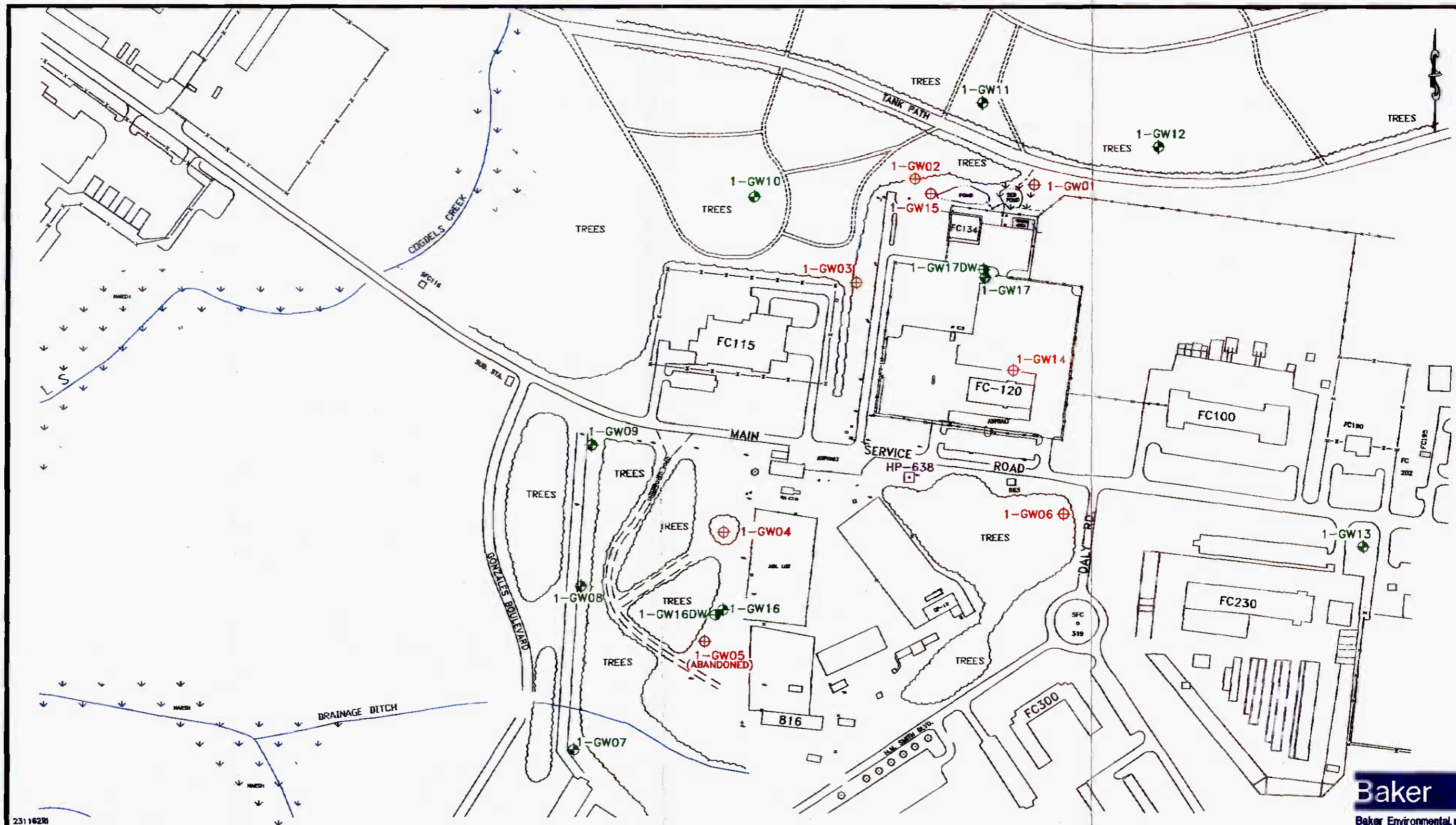

231162R

LEGEND

- 1-GW01 EXISTING SHALLOW MONITDRING WELL (ESE, 1984)
- 1-GW07 NEWLY INSTALLED SHALLOW MONITORING WELL (BAKER, 1994)
- 1-GW16DW NEWLY INSTALLED DEEP MONITORING WELL (BAKER, 1994)
- HP-638 EXISTING WATER SUPPLY WELL

SOURCE: LAMTDIV, FEBRUARY 1992 AND W.K. DICKSON & ASSOC., JUNE 1994

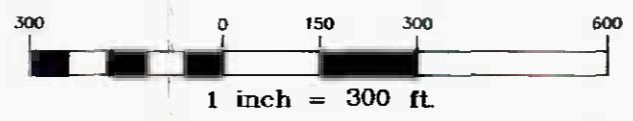
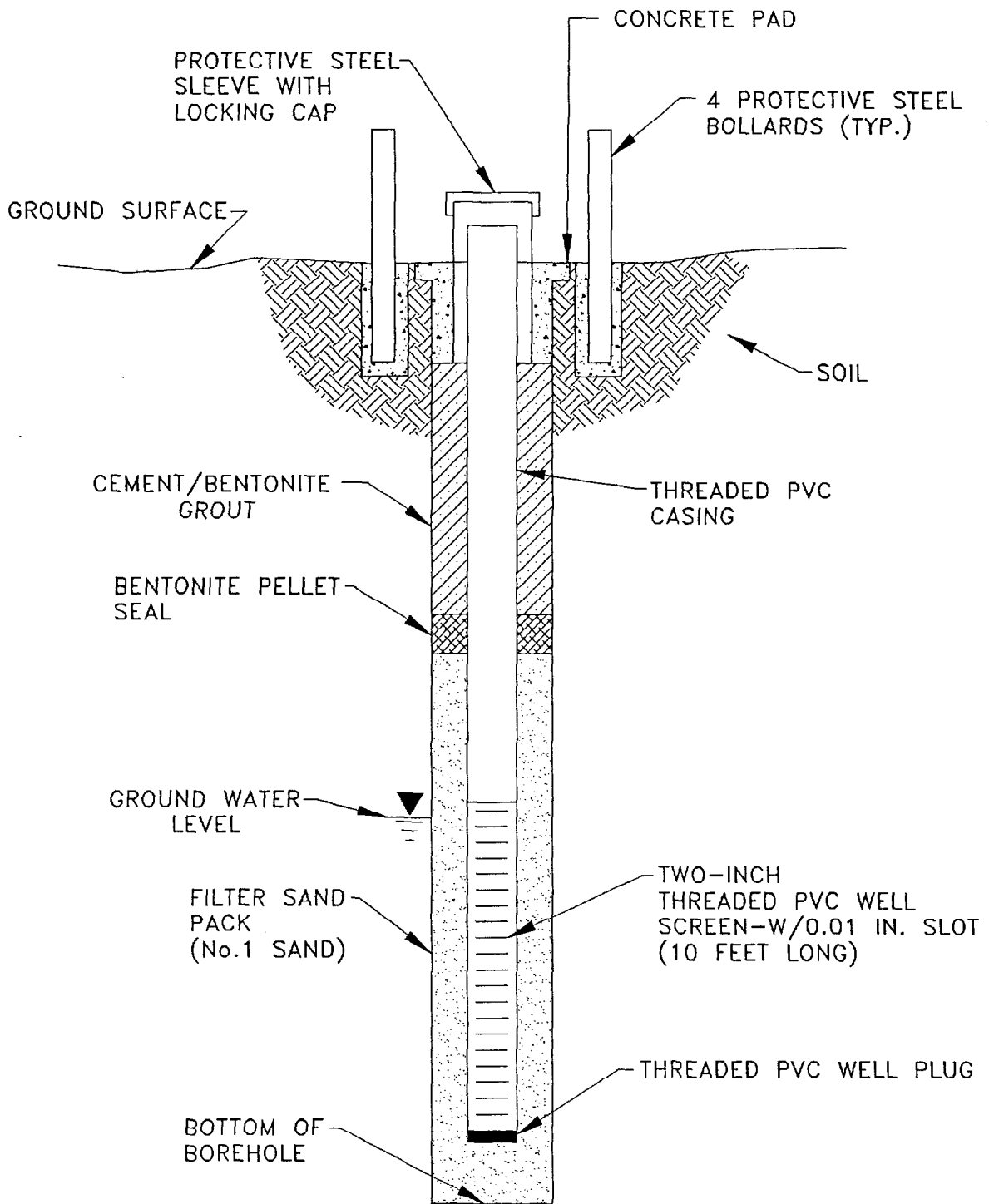

FIGURE 3-2
SHALLOW AND DEEP MONITORING WELL LOCATIONS
SITE 1 - FRENCH CREEK LIQUIDS DISPOSAL AREA
REMEDIAL INVESTIGATION CTO-0231

MARINE CORPS BASE, CAMP LEJEUNE
 NORTH CAROLINA

01499U07Y



N.T.S.



FIGURE 3-3
TYPICAL SHALLOW TYPE II GROUNDWATER
MONITORING WELL CONSTRUCTION DIAGRAM
REMEDIAL INVESTIGATION CTO-0231
MARINE CORPS BASE, CAMP LEJEUNE
NORTH CAROLINA

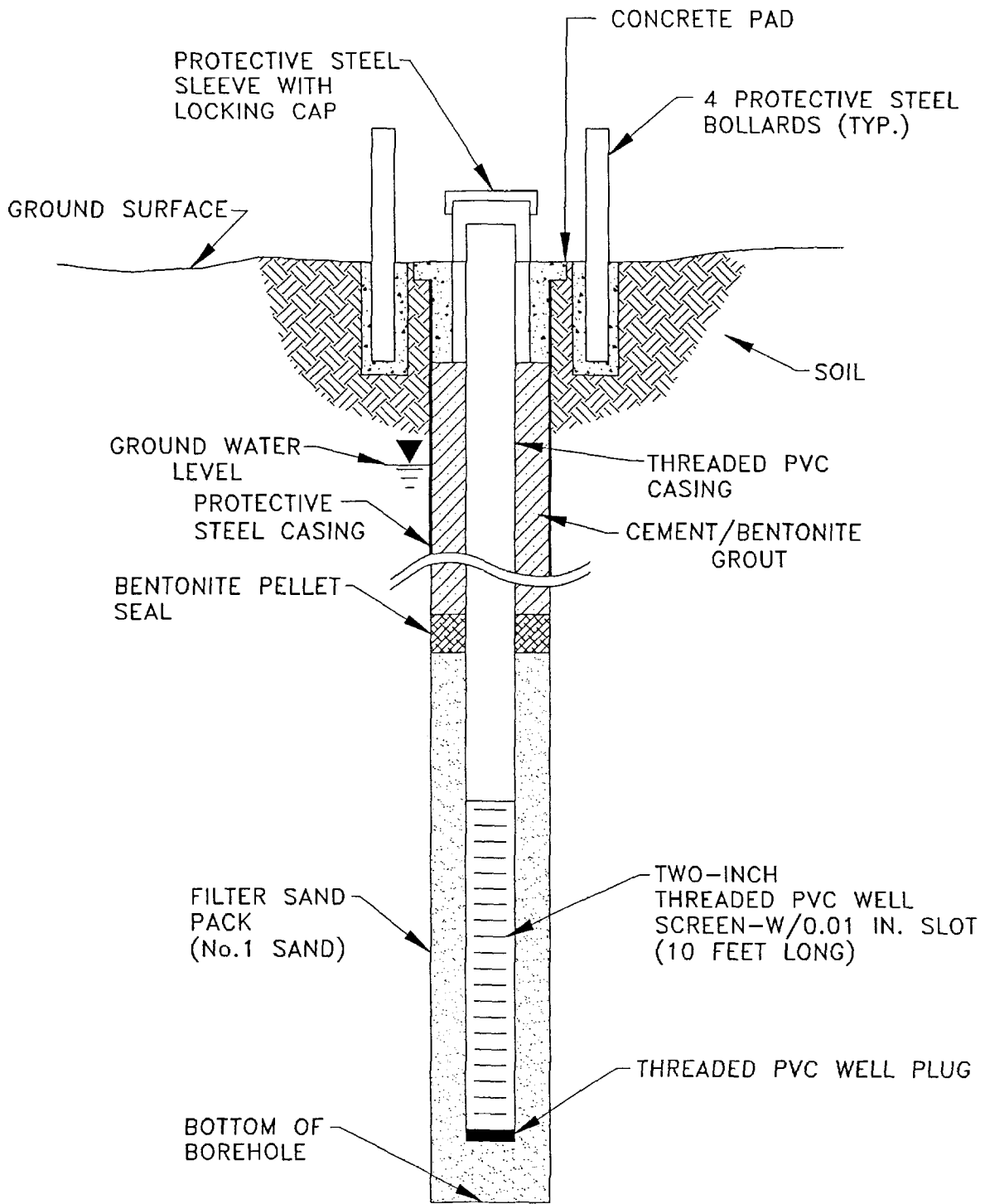

N.T.S.

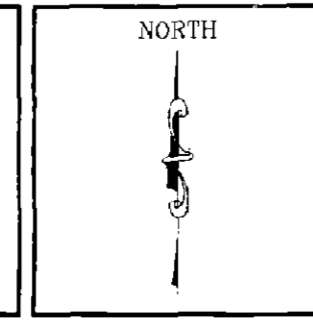

FIGURE 3-4
TYPICAL DEEP TYPE II GROUNDWATER
MONITORING WELL CONSTRUCTION DIAGRAM
REMEDIAL INVESTIGATION CTO-0231
MARINE CORPS BASE, CAMP LEJEUNE
NORTH CAROLINA



LEGEND	
1-GW1	PILOT TEST BORING FOR SHALLOW MONITORING WELL (BAKER, 1994)
1-GW16DW	PILOT TEST BORING FOR DEEP MONITORING WELL (BAKER, 1994)
SB1	SOIL BORING LOCATION (BAKER, 1994)
BB-SB38	BASE BACKGROUND SOIL BORING LOCATION
(Symbol)	VEGETATION
(Symbol)	FENCE
(Symbol)	CREEK/DRAINAGE
(Symbol)	MARSH
SOURCE: LANTOV, FEBRUARY 1992	

DATE	JANUARY 1995
SCALE	1" = 125'
DRAWN	REL
REVIEWED	TFT
S O #	62470-231-0000
CADD#	231161R1



REMEDIAL INVESTIGATION CTO-0231
 MARINE CORPS BASE, CAMP LEJEUNE
 NORTH CAROLINA

BAKER ENVIRONMENTAL, Inc.
 Coraopolis, Pennsylvania

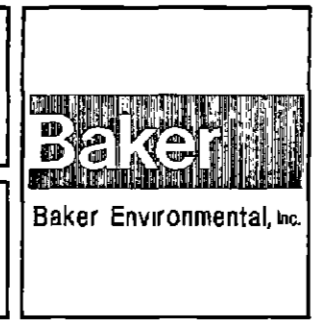

SURFACE AND SUBSURFACE SOIL SAMPLING LOCATIONS SITE 1 - FRENCH CREEK LIQUIDS DISPOSAL AREA	
SCALE	1" = 125'
DATE	JANUARY 1995

FIGURE No
3-1

014091105X

4.0 SITE PHYSICAL CHARACTERISTICS

Section 4.0 of this report presents information on site-specific physical characteristics. Included in this section is a discussion on the topography, surface water hydrology and drainage features, geology, hydrogeology, ecology, and water supply wells identified near the site.

4.1 Topography

Site 1 is situated within a relatively flat area with land surface elevations ranging between 15 and 25 feet above msl. Most of Site 1, however, is situated at 20 feet above msl. At the northern area of Site 1, north of Building FC-134, the land surface slopes to 5 feet above msl. This area, beyond existing wells 1-GW01 and 1-GW02, is swampy and appears to receive surface water runoff.

4.2 Surface Water Hydrology and Drainage Features

In the immediate vicinity of Site 1, there are several surface water features influencing drainage. In the southern area of Site 1, a drainage ditch, which eventually flows into Cogdels Creek, is located south of Building 816. This ditch receives surface water runoff from lower portion of the southern area and nearby parking lots. During the field investigation, most of the ditch was dry with ponded water in some areas. Within the northern area of Site 1, there are two surface water features influencing drainage. A retention pond, located behind Building FC-134, receives surface water runoff via a gravel ditch from the parking lot and the surrounding areas. Surface water runoff north of Building FC-134 drains into a swampy area toward a topographic low.

4.3 Subsurface Soil Conditions

4.3.1 Geology

The soils underlying Site 1 were generally uniform in the shallow and deep subsurface. Shallow soils (less than 30 feet bgs) consisted of mostly sand and silty-sand, with lenses of silt and clay. These soils represent the Quaternary age "undifferentiated" Formation, which characterizes the surficial water table aquifer. One to two feet of fill material was also noted underlying the site in many places.

The sands are fine-grained with varied amounts of silt (5 to 15 percent) and clay (less than 5 percent). Results of the standard penetration tests (commonly referred to as "blow counts," ASTM 1568) indicated that the sands have a relative density ranging from loose to very dense. Based on the visual-manual method for soil description (ASTM D-2488), the sands classify as SM according to Unified Soil Classification System (USCS).

Two deep soil borings, advanced to approximately 120 feet bgs, indicated generally uniform deep lithology. A mixture of sandy-clay and limestone fragments was encountered at approximately 25 to 27 feet bgs. Based on a geologic/hydrogeologic report published by the USGS (Harned, et al., 1989) for MCB, Camp Lejeune, the sandy-clay and limestone fragments represent the top of the River Bend Formation (Oligocene age), which includes the Castle Hayne aquifer. Sand, sand-shell mixtures, and limestone fragments within a sandy-clay matrix were encountered at depths below 55 feet bgs.

Geologic cross-sections depicting the shallow and deep soil lithologies were developed based on soils collected during the RI. As shown on Figure 4-1, both the northern and southern areas of Site 1 were traversed to provide a cross-sectional view of the lithology. Four shallow (A to A', B to B', C to C', and D to D') and one deep traverse (E to E') are presented.

Cross-sections A to A' (north to south) and B to B' (west to east) depict cross-sectional views of shallow soils within the southern area of Site 1. The cross-sections are presented on Figures 4-2 and 4-3, respectively. Fill material, consisting of sand and gravel, was encountered within the upper one to two feet bgs. Sand (fine-grained) with lenses of silt and clay is present below the fill material to depths of 20 to 30 feet bgs. The lenses of clay and silt are two to three feet thick, but are not continuous.

Cross-sections C to C' (north to south) and D to D' (west to east) depict cross-sectional views of shallow soils within the northern area of Site 1. As shown on Figures 4-4 and 4-5, sand is the dominate soil type underlying the area. Fill material, consisting of fine-grained sand, was noted within the first one to two feet bgs. During the installation of well boring 1-GW11, which is located north of the site, gravel, a sand-shell mixture, and limestone fragments within a sandy-clay matrix were encountered underlying the sand. These soils were noted from approximately seven feet to the termination of the boring at 22 feet bgs.

Deep soil conditions, depicted on Figure 4-6, represent soils from the northern to southern areas to a depth of approximately 122 feet. As depicted on Figure 4-6, soil within the upper 55 feet bgs is consistent with the shallow borings described above. The top of the River Bend Formation, marked by sand and limestone fragment mixtures, was encountered at approximately 25 to 27 feet bgs in well boring 1-GW17DW. Sand/silty-sand/sand-shell mixtures are present from approximately 55 to 100 feet bgs. A thin layer of sandy-clay was encountered at approximately 92 feet bgs. Although this sandy-clay is present, the soil appeared visually to have a high enough permeability to permit vertical groundwater movement into the deeper aquifer.

4.3.2 Surface Soils

Information regarding site soil conditions was obtained from the Soil Survey publication prepared by the U.S. Department of Agriculture - Soil Conservation Service (SCS) for Camp Lejeune, North Carolina (SCS, 1984). As part of the RI, a limited number of soil samples were evaluated for geotechnical properties and classified according to the USCS. The findings of that evaluation, provided in Appendix H, were used to confirm SCS survey results. Due to operational or construction activities at Site 1, however, the soils described in the SCS publication may differ from current site conditions.

According to the SCS Soil Survey, Site 1 is underlain by a single distinct soil unit. The Baymeade (BaB) urban land complex is typically found in areas where the original soil has been cut, filled or graded. Soil properties of this unit have been altered through slope modification and smoothing. Due to its rapid infiltration rate and well-drained nature, Baymeade soil tends to be used for parking lots and light-duty urban areas. Generally Baymeade soils are moderately to strongly acidic in nature and are classified under the USCS as SM, SM-SP (i.e., fine sand or loamy fine sand). Table 4-1 provides a summary of soil physical properties found at Site 1.

4.4 Hydrogeology

The hydrogeologic setting in the vicinity of Site 1 consists of several aquifer systems. For this study, the most upper two aquifer systems were investigated, the surficial and Castle Hayne. The surficial aquifer lies within the "undifferentiated" deposits of sand, silt, and clay. The thickness of the surficial aquifer in the vicinity of Site 1 is approximately 27 feet, based on the occurrence of the sand and limestone mixtures which mark the upper portion of the River Bend Formation. The underlying Castle Hayne aquifer consists of sand, silt, clay, shell hash, and limestone fragments. Based on the lithology encountered during the test borings, there does not appear to be a significant hydraulic separation of the two aquifers since no distinct groundwater retarding unit was encountered.

The hydrogeologic conditions were evaluated by installing a network of shallow and deep monitoring wells throughout the northern and southern portions of Site 1. Staff gauges were also proposed in the drainage ditch located in the southern portion of the site; however, the ditch was dry throughout most of the investigation.

Groundwater elevation data for Site 1 are summarized on Table 4-2. Two rounds of groundwater level measurements were collected. The initial round of measurements (March 19, 1994) was collected prior to the investigation and, therefore only include the existing wells. Groundwater elevations measured in the shallow wells on May 9, 1994, varied from 5.36 to 12.00 feet above msl. In the existing monitoring wells where two rounds of measurements were collected (March 19 and May 9, 1994), the water levels declined between 0.69 and 1.80 feet. The decline in the water table appears to be the result of normal daily and/or seasonal fluctuations. Groundwater elevations measured in the deep wells varied from 6.47 to 7.65 feet above msl. Slightly different groundwater elevations between the surficial and deep aquifers were measured. The elevation differentials between the surficial and deep aquifers have created a slight downward vertical gradient which is noteworthy since this may contribute to the vertical migration of contaminants.

A groundwater elevation contour map for the surficial aquifer was generated based on the May 9, 1994 data. Elevation data from existing well 1-GW01 was not used for generating the contour map due to the recharging effect (i.e., elevation low) of groundwater near the sedimentation pond. A contour map for the deep aquifer was not developed because of the limited number of wells. As shown on Figure 4-7, groundwater flow is generally west-northwest across Site 1 in the direction of the New River. Groundwater flow direction evaluated during previous investigations (ESE, 1990) also determined similar results. Although a contour map was not developed for the deep aquifer, flow is also expected to be in a west-northwest direction due to the influence of the New River. An estimate of the horizontal groundwater gradient for the surficial aquifer calculated from the May 9, 1994 elevation data is 0.0027 (to the west-northwest), indicating a relatively flat water table surface.

Groundwater flow velocity within the surficial aquifer was estimated by employing a variation of Darcy's equation:

$$V = Ki/n_e$$

where:

V = groundwater velocity (feet/day)

K = hydraulic conductivity (feet/day)

i = horizontal groundwater gradient (feet/foot)
 n_e = effective porosity

Based on an average hydraulic conductivity of 3.3 feet/day from studies conducted within the Hadnot Point Industrial Area, an average horizontal groundwater gradient of 0.0027, and an estimated effective porosity of 0.3 for silty-sands (Fetter, 1980), the estimated groundwater flow velocity is 2.9×10^{-2} feet/day (10 feet/year).

4.5 Ecology

Site 1 is located in a primarily industrial area surrounded by mixed forests. To the west of the site, forested wetlands are present along two tributaries to Cogdels Creek. These wetlands lead to a larger palustrine, forested, broad-leaved deciduous, needle-leaved evergreen wetland which are identified on the NEI maps. Site-specific habitat types are summarized on Table 4-3 and a biohabitat map for Site 1 is presented as Figure 4-8.

The area along the channel of the drainage ditch, located along the southern edge of Site 1, is described as narrow strips of mixed forest and scrub/shrub. Dominant vegetation includes: gray birch (Betula populifolia), red maple (Acer rubrum), Spanish oak (Q. falcata), loblolly pine (Pinus taeda), southern bayberry (Myrica cerifera), and American holly (Ilex opaca). Several species of mammals were also observed at the site including gray squirrel (Sciurus carolinensis), raccoon (Procyon lotor), and wood rat (Neotoma sp.).

The area located within the pipeline right of way, located along the south western section of Site 1, is described as a narrow strip of cultivated grasses and herbaceous growth. The dominant vegetation is a herbaceous layer of unidentified grasses and upland plants. These small grassy fields make excellent habitat for small mammals, the bobwhite quail (Colinus virginianus), and song birds.

The area surrounding most of Site 1 is described as coniferous forest in varying levels of development. Loblolly pine (Pinus taeda), red cedar (Juniperus virginiana), and scrub/shrub vegetation are the dominant vegetation in these areas. Song birds and small mammals such as the gray squirrel (Sciurus carolinensis), raccoon (Procyon lotor) and wood rat (Neotoma sp.) may inhabit these areas.

4.6 Identification of Water Supply Wells

Potable water supply wells within a one-mile radius of the site were identified by reviewing a USGS publication (Harned, et al., 1989) and conducting interviews with Activity personnel. Four supply wells, HP-608, HP-609, HP-638 (located within site boundary), and HP-655, were identified within a one-mile radius of the site. According to Base personnel, wells HP-608, HP-638, and HP-655 are no longer in service due to contamination. Table 4-4 summarizes well construction details and Figure 4-9 shows the locations of the supply wells.

Well HP-638 was sampled in 1984 (WAR, 1984) and 1992 (Greenhorn and O'Mara, 1992). Results from the 1984 sampling indicated non-detectable concentrations of VOCs and metals. Benzene at 2.0 micrograms per liter ($\mu\text{g/L}$), which is above the North Carolina Water Quality Standard (NCWQS) of 1.0 $\mu\text{g/L}$, was detected in 1992. Subsequently, the well was taken out of service due to the benzene contamination. The potential sources of the benzene include the numerous

maintenance facilities in the area, Site 1 (past and current activities), and an aboveground fuel tank (used for a emergency generator) formerly located next to the well house.

Well HP-608 was sampled in 1984 and 1985 (Geophex, Ltd. 1991). Results from the 1984 sampling indicated concentrations of 1,2-dichloroethene (5.4 µg/L), TCE (110 µg/L), and benzene (3.7 µg/L). Further, the 1985 results indicated concentrations of TCE (9.0 µg/L) and benzene (1.6 µg/L). The sources of these contaminants are believed to have originated from vehicle maintenance shops and fuel storage tanks located within the Hadnot Point Industrial Area.

SECTION 4.0 TABLES

TABLE 4-1

SUMMARY OF SOIL PHYSICAL PROPERTIES
 SITE 1, FRENCH CREEK LIQUIDS DISPOSAL AREA
 REMEDIAL INVESTIGATION, CTO-0231
 MCB, CAMP LEJEUNE, NORTH CAROLINA

Soil Name	Soil Symbol	USCS Classification	Depth (inches)	Moist Bulk Density (g/cc)	Permeability (cm/s)	Soil Reaction (pH)	Shrink-Swell Potential	Organic Matter (percent)
Baymeade-Urban	BaB	SM, SP-SM	0 - 30	1.60 - 1.75	$4.2 \times 10^{-3} - 1.37 \times 10^{-2}$	4.5 - 6.5	Low	0.5 - 1.0

Source: Soil Survey: Camp Lejeune, North Carolina, U. S. Department of Agriculture - Soil Conservation Service, 1984.

Notes: SM - Loamy Fine Sand
 SP - Fine Sand

TABLE 4-2

SUMMARY OF WATER LEVEL MEASUREMENTS ON MARCH 19, 1994, AND MAY 9, 1994
 SITE 1, FRENCH CREEK LIQUIDS DISPOSAL AREA
 REMEDIAL INVESTIGATION, CTO-0231
 MCB, CAMP LEJEUNE, NORTH CAROLINA

Well No.	Top of PVC Casing Elevation (feet, above msl) ⁽¹⁾	Depth to Groundwater (feet, below top of casing) March 19, 1994	Depth to Groundwater (feet, below top of casing) May 9, 1994	Groundwater Elevation (feet, above msl) March 19, 1994	Groundwater Elevation (feet, above msl) May 9, 1994
1-GW01	16.50	8.10	9.75	8.40	6.75
1-GW02	17.95	9.07	10.87	8.88	7.08
1-GW03	21.78	13.31	14.40	8.47	7.38
1-GW04	24.41	18.20	18.89	6.21	5.52
1-GW06	27.52	17.11	17.92	10.41	9.60
1-GW07	23.12	(2)	16.66	(2)	6.46
1-GW08	22.31	(2)	16.93	(2)	5.38
1-GW09	17.62	(2)	12.26	(2)	5.36
1-GW10	18.07	(2)	12.28	(2)	5.79
1-GW11	13.18	(2)	6.16	(2)	7.02
1-GW12	16.33	(2)	8.08	(2)	8.25
1-GW13	32.33	(2)	20.33	(2)	12.00
1-GW14	24.52	(2)	16.32	(2)	8.20
1-GW15	16.62	8.48	9.22	8.14	7.40
1-GW16	23.71	(2)	17.99	(2)	5.72
1-GW17	23.00	(2)	15.43	(2)	7.57
1-GW16DW ⁽⁴⁾	23.50	(2)	17.03	(2)	6.47
1-GW17DW ⁽³⁾⁽⁴⁾	21.91	(2)	(2)	(2)	(2)

- (1) msl = mean sea level
- (2) Data not collected.
- (3) Groundwater elevation measured on May 16, 1994 at 7.65 feet above msl.
- (4) Deep monitoring well.

TABLE 4-3

**SUMMARY OF HABITAT TYPES
SITE 1, FRENCH CREEK LIQUIDS DISPOSAL AREA
REMEDIAL INVESTIGATION, CTO-0231
MCB, CAMP LEJEUNE, NORTH CAROLINA**

Area Designation	Site Description	Dominant Vegetation	Fauna Present
1A	This area is described as a gravel surface storage area for heavy equipment and portable bridges.	No vegetation was noted in this area.	Small mammals such as mice, chipmunk and wood rat may inhabit this area.
1B	These areas are described as narrow strips of mixed forest and scrub/shrub located along the channel of a intermittent stream, located along the southern edge of Site 1.	Dominant vegetation includes gray birch, red maple, Spanish oak, and loblolly pine. Southern bayberry, American holly, and red maple dominate the scrub/shrub vegetation.	Song birds and small mammals such as gray squirrel, raccoon, and wood rat may inhabit this area.
1C	These areas are described as coniferous forest in varying levels of development. These areas are adjacent to Area 1B.	Loblolly pine and red cedar are the dominant tree and scrub/shrub vegetation of these areas.	Song birds and small mammals such as gray squirrel, raccoon, and wood rat may inhabit this area.
1D	This area is described as a narrow strip of cultivated grasses and herbaceous growth located within the pipeline right-of-way.	The dominant vegetation is a herbaceous layer of unknown grasses and upland plants.	These small grassy fields make excellent habitat for small mammals, bobwhite, quail and song birds.

Note: Refer to Figure 4-8 for area designation location

TABLE 4-4

SUMMARY OF POTABLE WATER SUPPLY WELLS
 WITHIN A ONE-MILE RADIUS
 SITE 1, FRENCH CREEK LIQUIDS DISPOSAL AREA
 REMEDIAL INVESTIGATION, CTO-0231
 MCB, CAMP LEJEUNE, NORTH CAROLINA

Supply Well Number	Well Depth (feet)	Screened Interval (feet)	Well Diameter (inches)	Approximate Distance/Direction to Closest Site ⁽³⁾ (feet)	Status of Well
HP-608	161.5	61.5-81.5 91.5-101.5 121.5-131.5 151.5-161.5	8	3,900/Northwest	Off
HP-609	150	65-80 100-110 130-150	8	3,800/Northeast	On
HP-638	196	106-114 126-134 150-158 162-170 176-184 188-196	8	Within site boundary	Off
HP-655	145	NA ⁽²⁾	NA	3,200/East	Off

Notes: ⁽¹⁾ Information obtained from "USGS Water Resources Investigation Report 89-4096" (Hamed, et. al., 1989).

⁽²⁾ Information not available.

⁽³⁾ Distance measured from site boundary.

Refer to Figure 4-9 for the locations of the supply wells.

SECTION 4.0 FIGURES

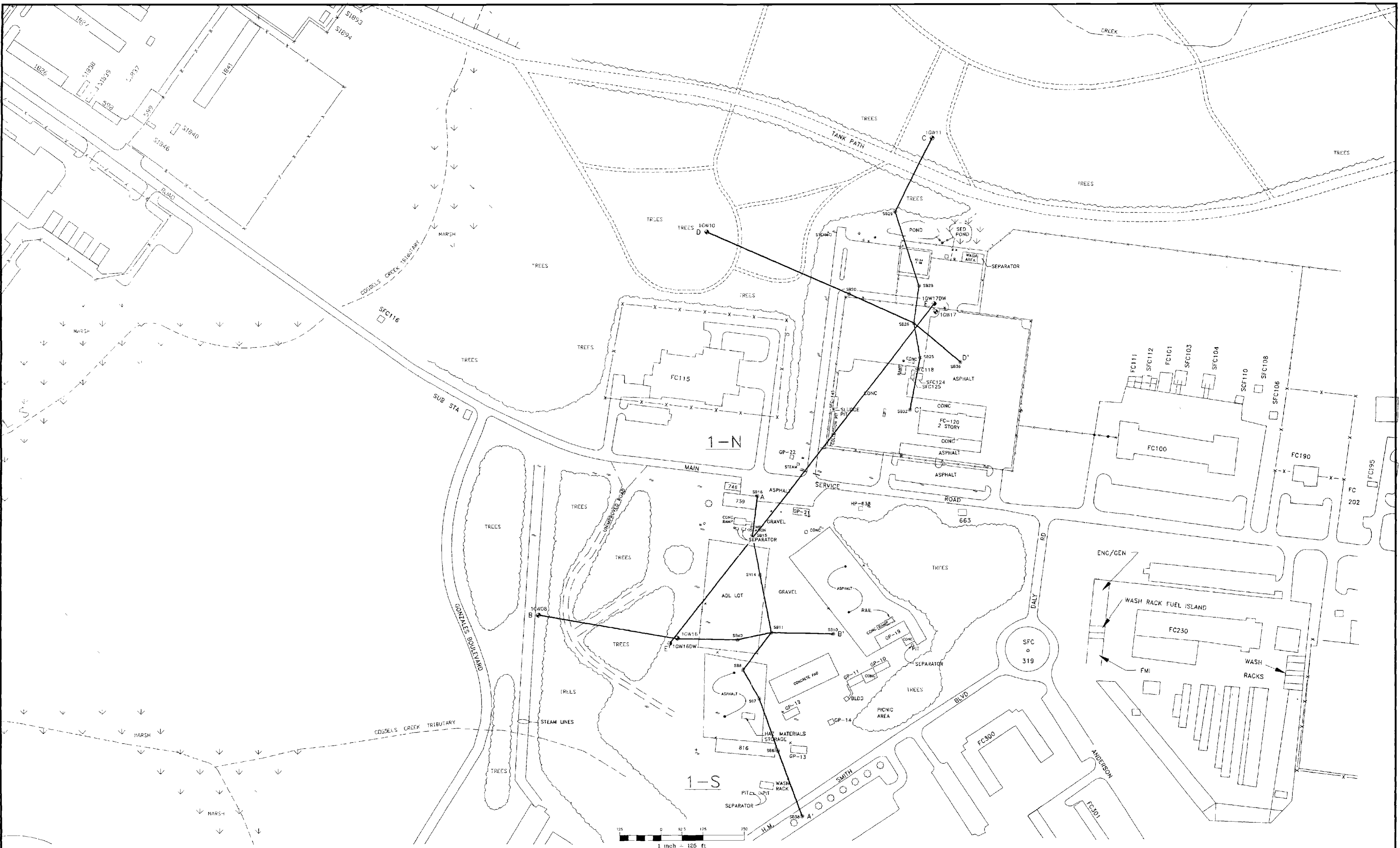

LEGEND	
1GW05	NEWLY INSTALLED SHALLOW MONITORING WELL
1GW16DW	NEWLY INSTALLED DEEP MONITORING WELL
SB6	SOIL BORING
A - A'	GEOLOGIC CROSS-SECTION TRAVERSE

DATE	JANUARY 1995
SCALE	1" = 125'
DRAWN	REL
REVIEWED	TFT
SO #	62470-231-0000
CADD#	231113RI

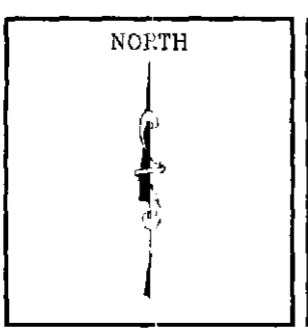

REMEDIAL INVESTIGATION CTO-0231
 MARINE CORPS BASE, CAMP LEJEUNE
 NORTH CAROLINA

BAKER ENVIRONMENTAL, Inc
 Coraopolis, Pennsylvania

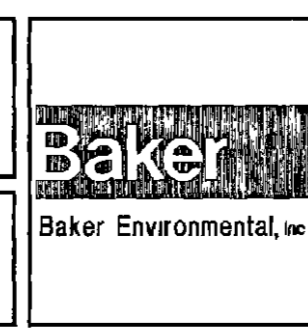

GEOLOGIC CROSS-SECTION LOCATION MAP
 SITE 1 - FRENCH CREEK
 LIQUIDS DISPOSAL AREA

SCALE 1" = 125' DATE JANUARY 1995

FIGURE No
4--1

SOURCE: LANTIDY, FEBRUARY 1992

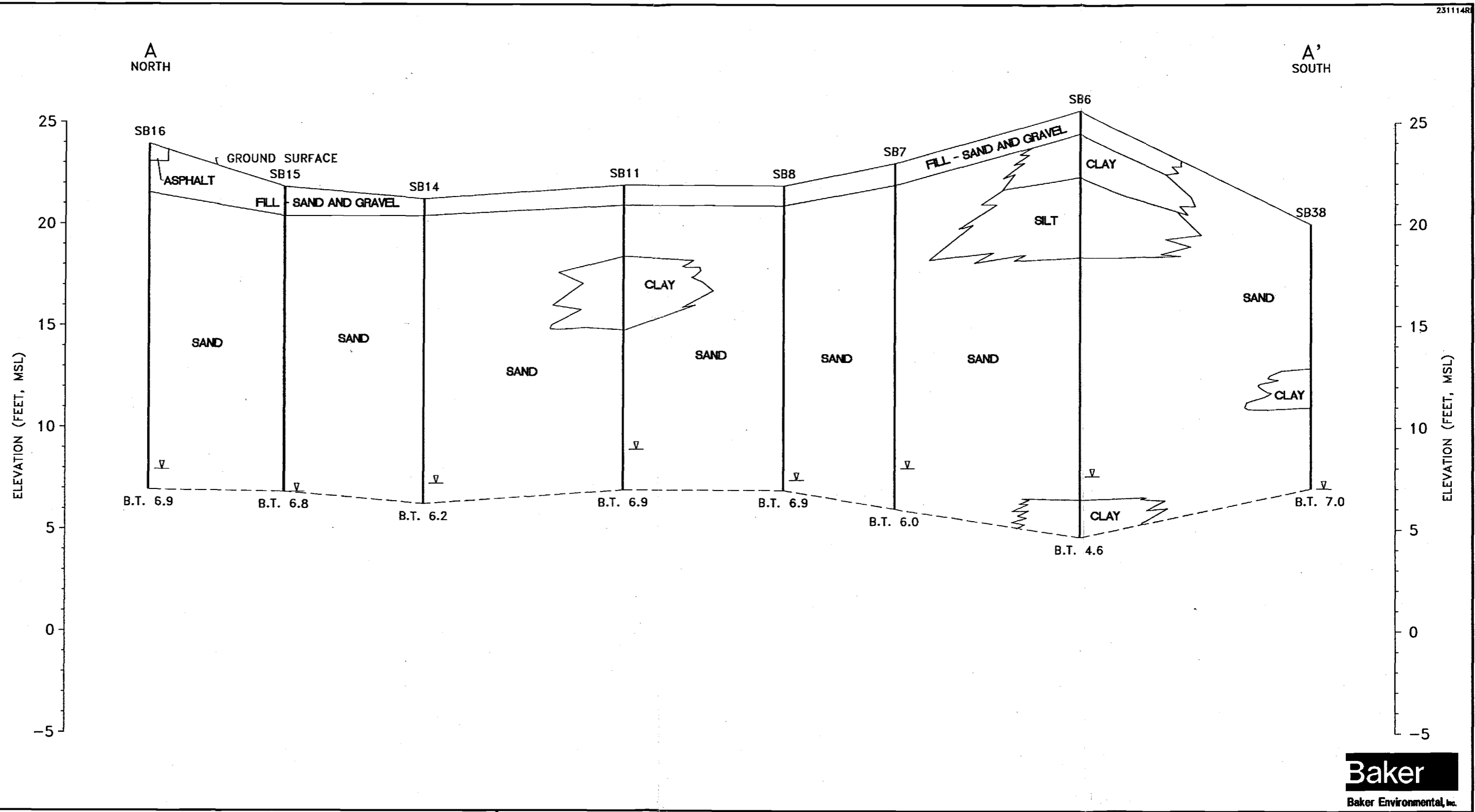

Baker
Baker Environmental, Inc.

LEGEND

▽ GROUNDWATER ENCOUNTERED DURING DRILLING
 B.T. 6.9' BORING TERMINATED, ELEVATION MSL
 ▮ WELL SCREEN INTERVAL
 ——— ESTIMATED - - - - - PROJECTED

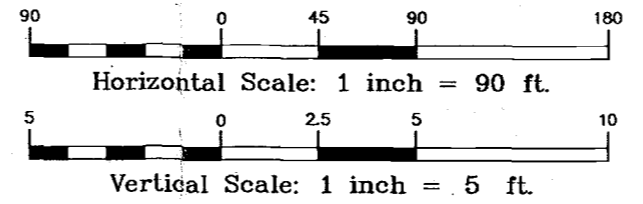

THE SOIL BORING INFORMATION IS CONSIDERED TO BE REPRESENTATIVE OF SUBSURFACE CONDITIONS AT THE RESPECTIVE BORING LOCATIONS. SUBSURFACE CONDITIONS INTERPOLATED BETWEEN BORINGS ARE ESTIMATED BASED ON ACCEPTED SOIL ENGINEERING PRINCIPLES AND GEOLOGIC JUDGEMENT.

FIGURE 4-2
 GEOLOGIC CROSS-SECTION A-A'
 SHALLOW SOIL LITHOLOGY
 SITE 1
 REMEDIAL INVESTIGATION CTO-0231

MARINE CORPS BASE, CAMP LEJEUNE
 NORTH CAROLINA

01499U10Z

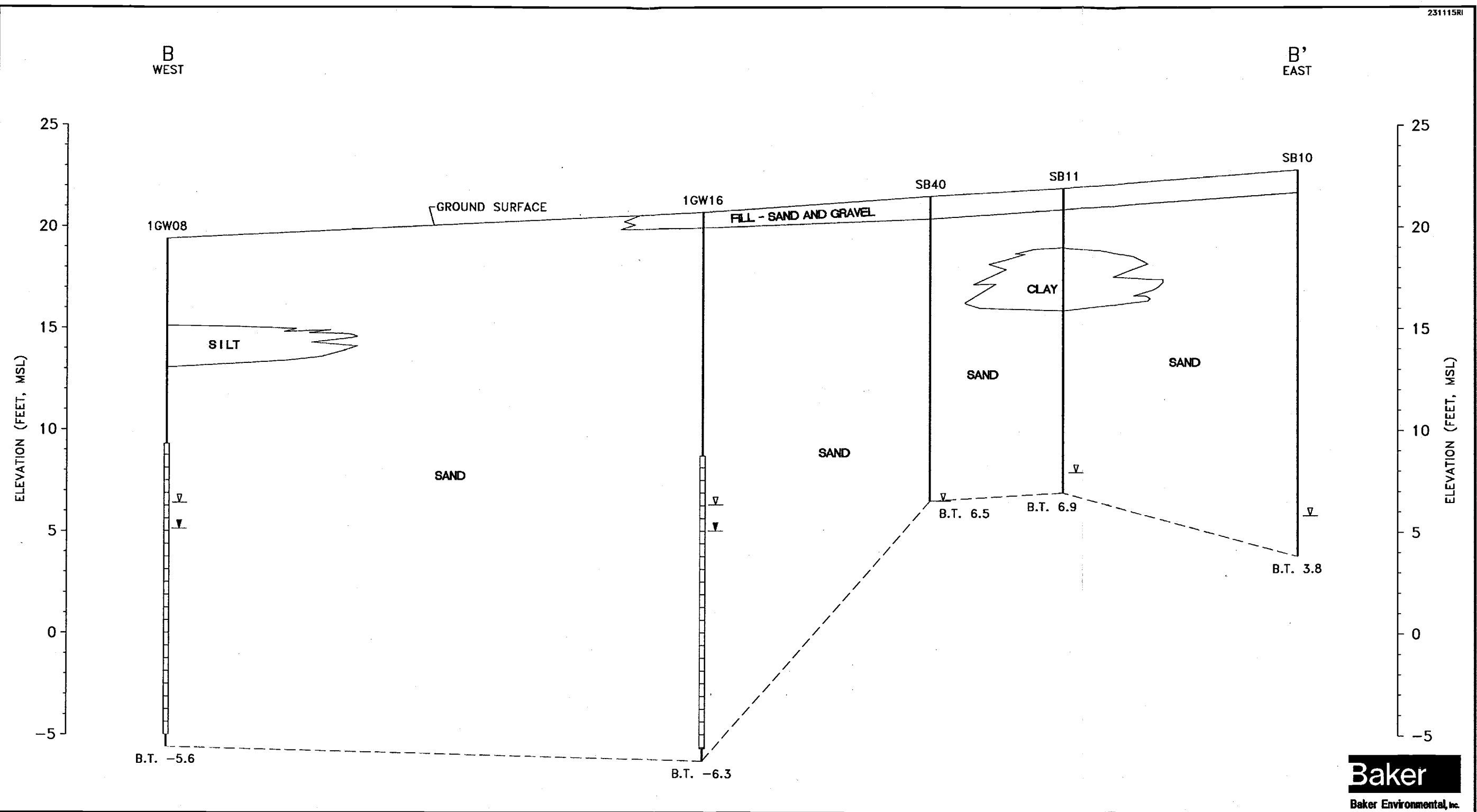

LEGEND

	GROUNDWATER ELEVATION (5/9/94)
	GROUNDWATER ENCOUNTERED DURING DRILLING
B.T. -5.6'	BORING TERMINATED, ELEVATION MSL
	WELL SCREEN INTERVAL
	ESTIMATED
	PROJECTED

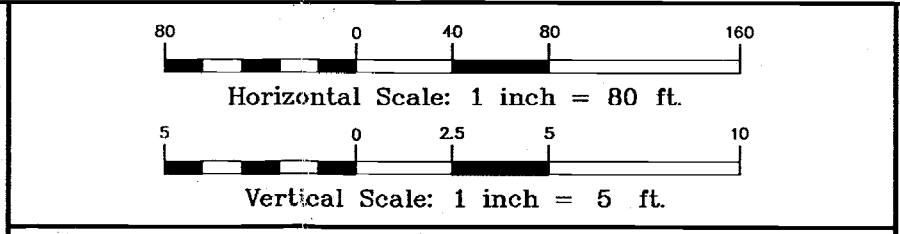

THE SOIL BORING INFORMATION IS CONSIDERED TO BE REPRESENTATIVE OF SUBSURFACE CONDITIONS AT THE RESPECTIVE BORING LOCATIONS. SUBSURFACE CONDITIONS INTERPOLATED BETWEEN BORINGS ARE ESTIMATED BASED ON ACCEPTED SOIL ENGINEERING PRINCIPLES AND GEOLOGIC JUDGEMENT.

FIGURE 4-3
GEOLOGIC CROSS-SECTION B-B'
SHALLOW SOIL LITHOLOGY
SITE 1
REMEDIAL INVESTIGATION CTO-0231

MARINE CORPS BASE, CAMP LEJEUNE
 NORTH CAROLINA



014990112

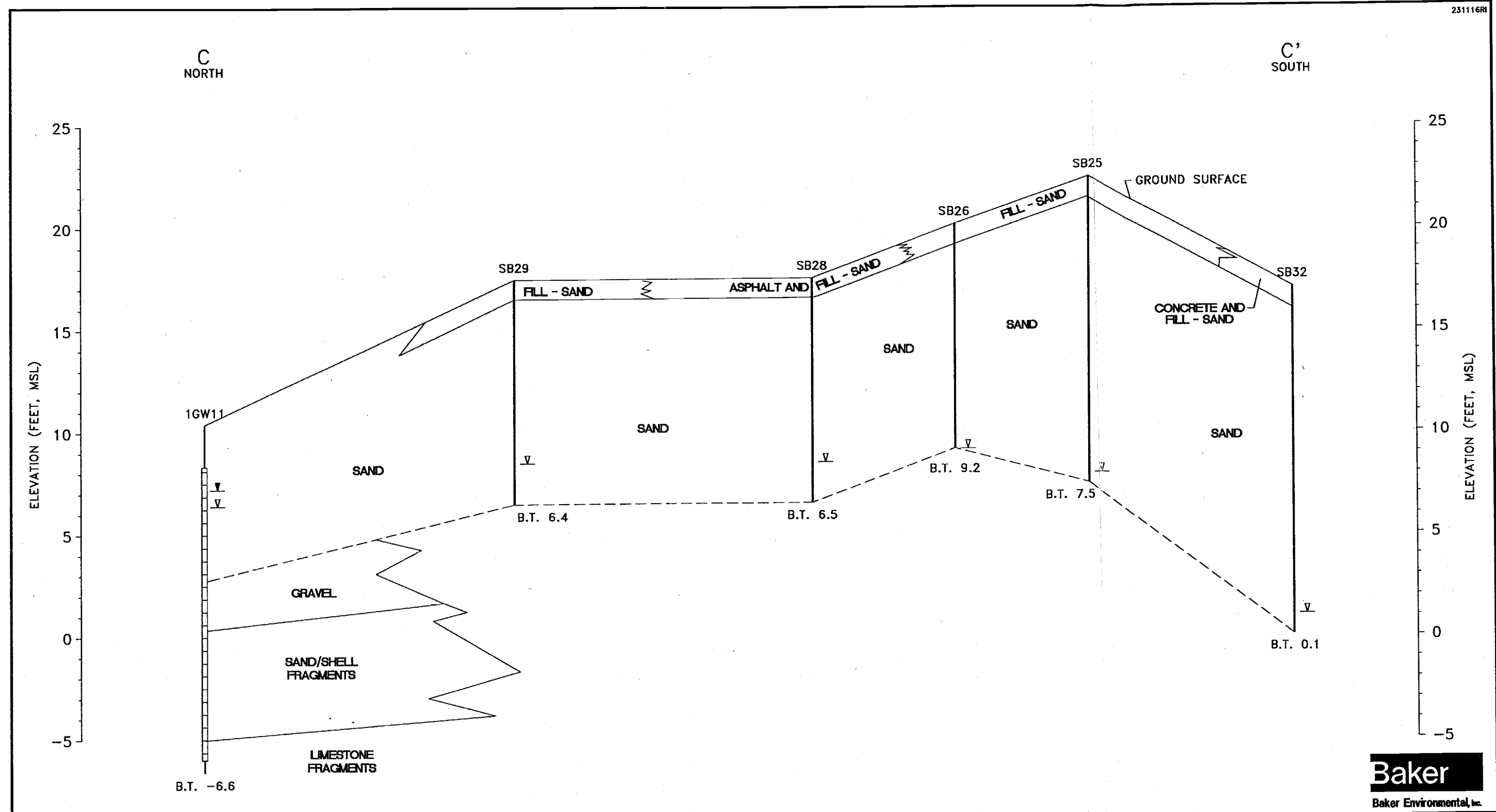

LEGEND

- ▽ GROUNDWATER ELEVATION (5/9/94)
- ▽ GROUNDWATER ENCOUNTERED DURING DRILLING
- B.T. -6.6' BORING TERMINATED, ELEVATION MSL
- ▭ WELL SCREEN INTERVAL
- ESTIMATED - - - PROJECTED

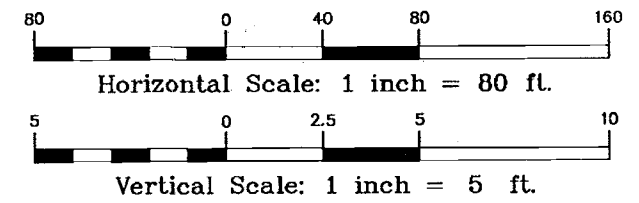

THE SOIL BORING INFORMATION IS CONSIDERED TO BE REPRESENTATIVE OF SUBSURFACE CONDITIONS AT THE RESPECTIVE BORING LOCATIONS. SUBSURFACE CONDITIONS INTERPOLATED BETWEEN BORINGS ARE ESTIMATED BASED ON ACCEPTED SOIL ENGINEERING PRINCIPLES AND GEOLOGIC JUDGEMENT.

FIGURE 4-4
GEOLOGIC CROSS-SECTION C-C'
SHALLOW SOIL LITHOLOGY
SITE 1
REMEDIAL INVESTIGATION CTO-0231

MARINE CORPS BASE, CAMP LEJEUNE
NORTH CAROLINA

01499U122

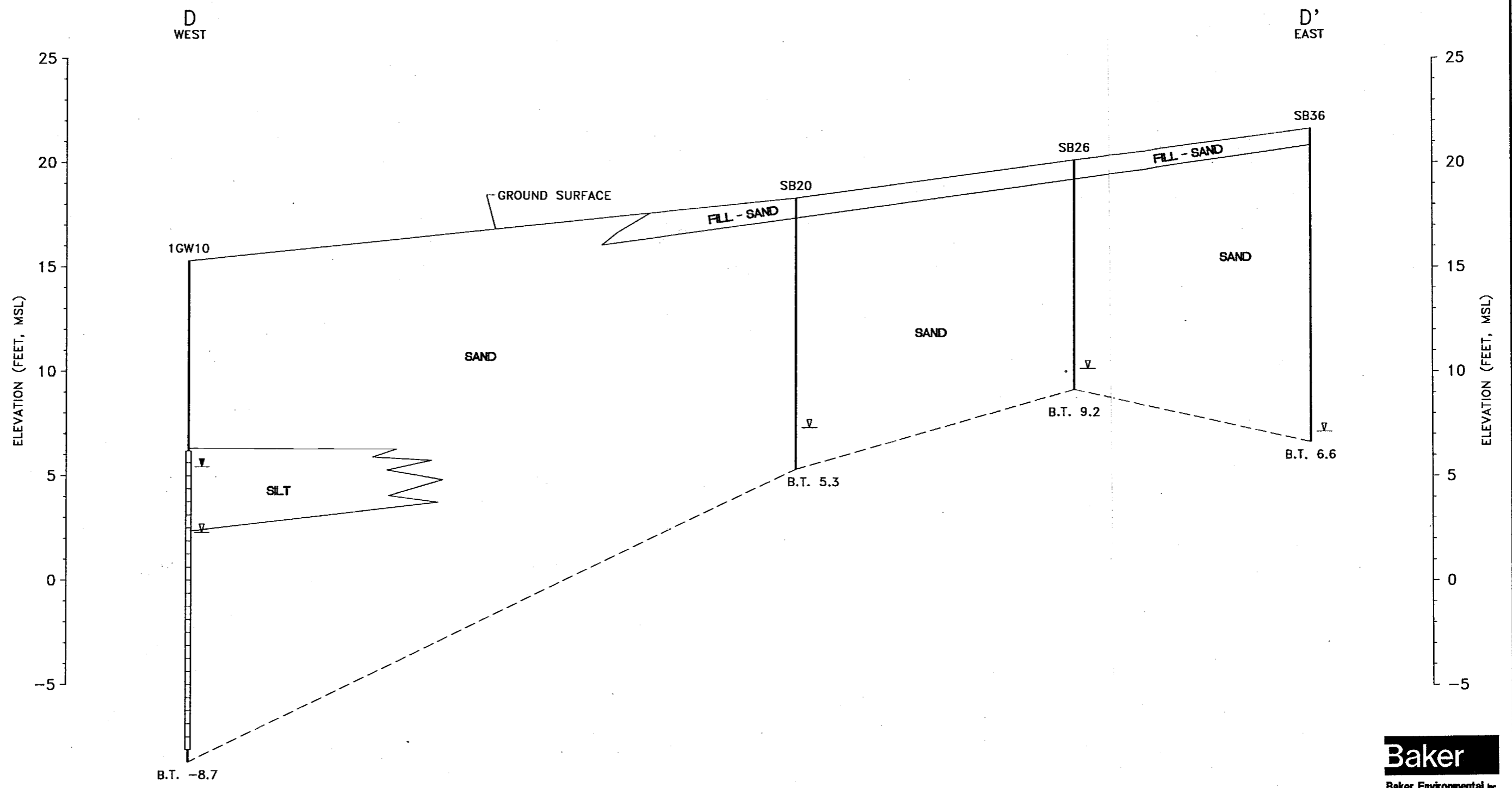

LEGEND

▼	GROUNDWATER ELEVATION (5/9/94)
▽	GROUNDWATER ENCOUNTERED DURING DRILLING
B.T. -8.7'	BORING TERMINATED, ELEVATION MSL
□	WELL SCREEN INTERVAL
—	ESTIMATED
- - -	PROJECTED

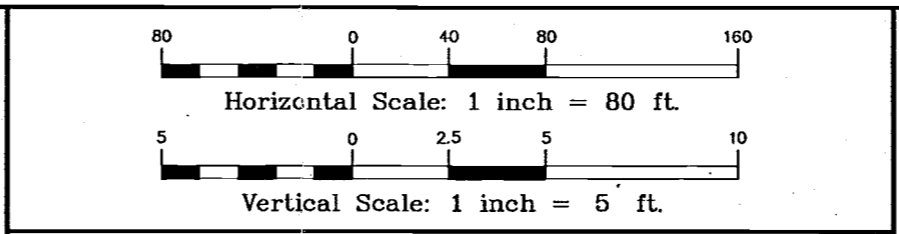

THE SOIL BORING INFORMATION IS CONSIDERED TO BE REPRESENTATIVE OF SUBSURFACE CONDITIONS AT THE RESPECTIVE BORING LOCATIONS. SUBSURFACE CONDITIONS INTERPOLATED BETWEEN BORINGS ARE ESTIMATED BASED ON ACCEPTED SOIL ENGINEERING PRINCIPLES AND GEOLOGIC JUDGEMENT.

FIGURE 4-5
GEOLOGIC CROSS-SECTION D-D'
SHALLOW SOIL LITHOLOGY
SITE 1
REMEDIAL INVESTIGATION CTO-0231

MARINE CORPS BASE, CAMP LEJEUNE
 NORTH CAROLINA

01499013Z

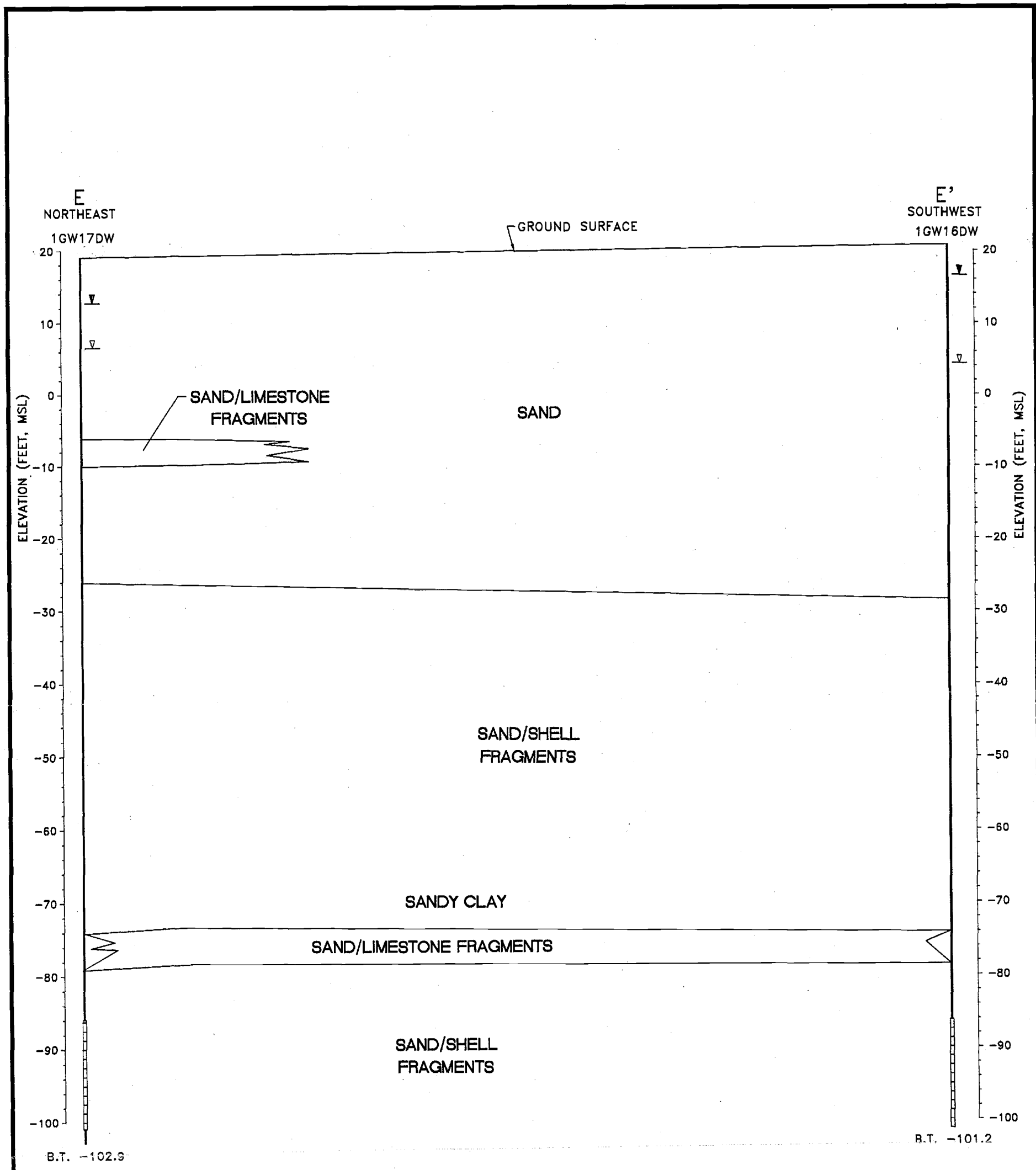

THE SOIL BORING INFORMATION IS CONSIDERED TO BE REPRESENTATIVE OF SUBSURFACE CONDITIONS AT THE RESPECTIVE BORING LOCATIONS. SUBSURFACE CONDITIONS INTERPOLATED BETWEEN BORINGS ARE ESTIMATED BASED ON ACCEPTED SOIL ENGINEERING PRINCIPLES AND GEOLOGIC JUDGEMENT.

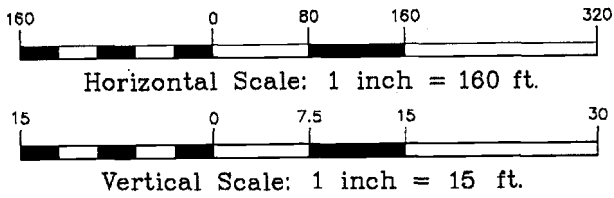

231118RI

LEGEND

	GROUNDWATER ELEVATION (5/9/94, 5/16/94)
	GROUNDWATER ENCOUNTERED DURING DRILLING
B.T. -102.9'	BORING TERMINATED, ELEVATION MSL
	WELL SCREEN INTERVAL
	ESTIMATED
	PROJECTED

FIGURE 4-6
GEOLOGIC CROSS-SECTION E-E'
DEEP SOIL LITHOLOGY
SITE 1
REMEDIAL INVESTIGATION CTO-0231
MARINE CORPS BASE, CAMP LEJEUNE
NORTH CAROLINA

014990142



NOTES
 -ALL CONCENTRATIONS REPORTED IN MICROGRAMS PER KILOGRAM (ug/kg)
 -BORINGS SHOWN WITHOUT CONCENTRATIONS INDICATE NONDETECTABLE LEVELS

LEGEND	
	PILOT TEST BORING FOR SHALLOW MONITORING WELL
	PILOT TEST BORING FOR DEEP MONITORING WELL
	SOIL BORING LOCATION
	WATER SUPPLY WELL
	VEGETATION
	FENCE
	CREEK/DRAINAGE
	MARSH
SOURCE: LANTOIV, FEBRUARY 1992	

DATE	JANUARY 1995
SCALE	1" = 125'
DRAWN	REL
REVIEWED	TFT
SO #	62470-231-0000
CADD#	231147R1

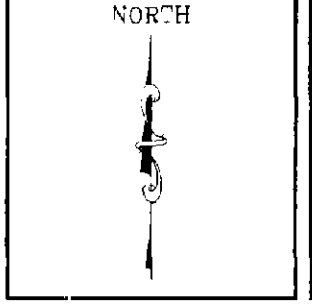

REMEDIAL INVESTIGATION CTO-0231
 MARINE CORPS BASE, CAMP LEJEUNE
 NORTH CAROLINA

BAKER ENVIRONMENTAL, Inc
 Coraopolis, Pennsylvania

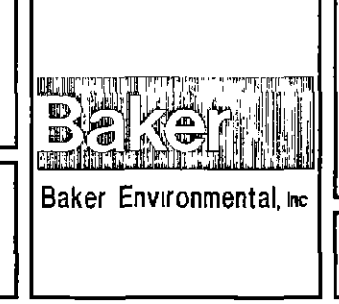

POSITIVE DETECTIONS OF ORGANIC
 COMPOUNDS IN SUBSURFACE SOILS
 SITE 1 - FRENCH CREEK
 LIQUIDS DISPOSAL AREA

SCALE: 1" = 125' DATE: JANUARY 1995

FIGURE No
5-2

01499V15X

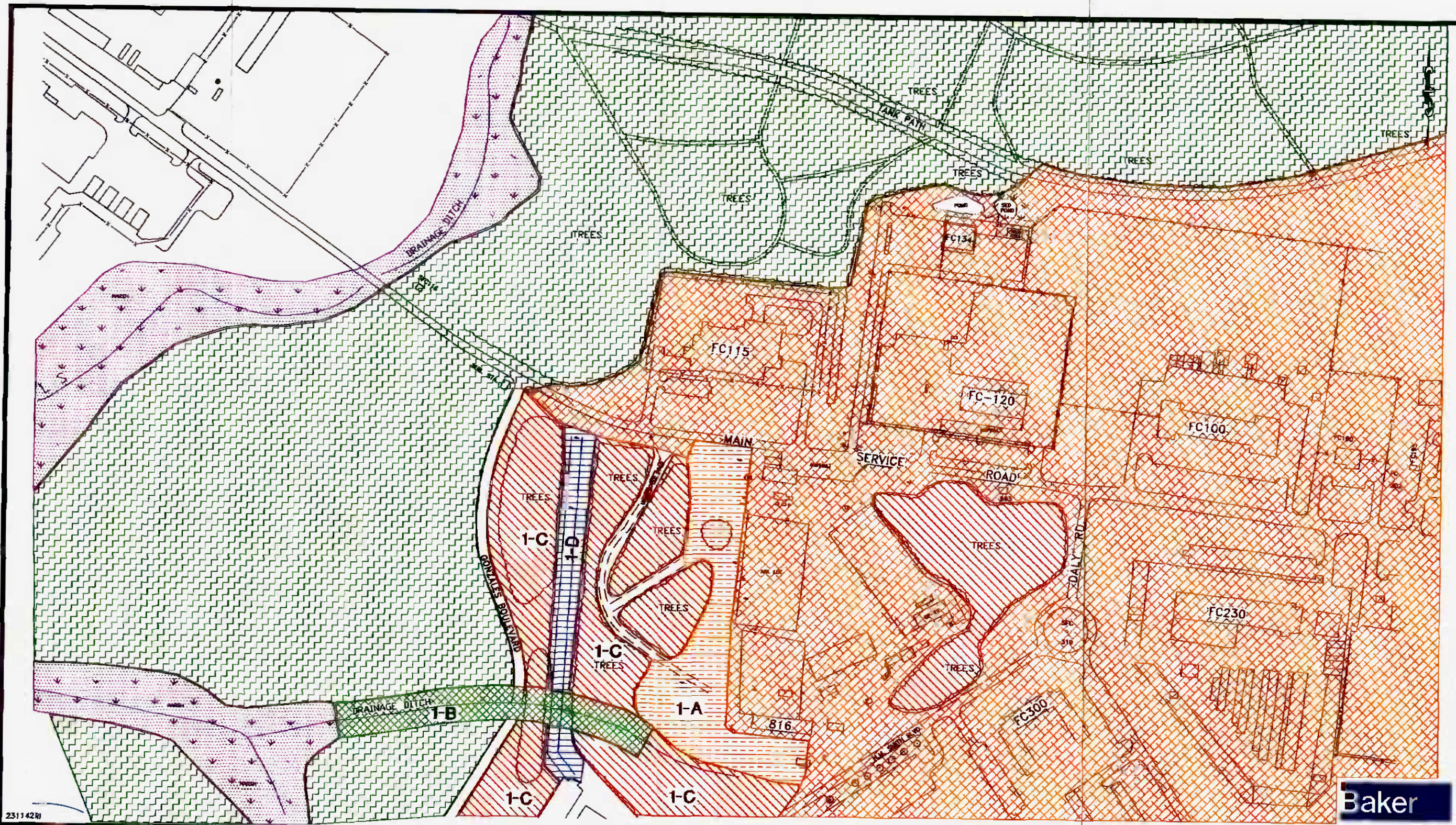

231142R

LEGEND	
INDUSTRIAL AREA	MIXED FOREST (DECIDUOUS/CONIFEROUS)
MIXED FOREST SCRUB/SHRUB	FORESTED SCRUB/SHRUB WETLAND
CULTIVATED GRASS AREA	1-A AREA DESIGNATION - REFER TO TABLE 4-3
CONIFEROUS FOREST	
GRAVEL AREA	

SOURCE: LANTDIV, FEBRUARY 1992 AND W.K. DICKSON & ASSOC., JUNE 1994

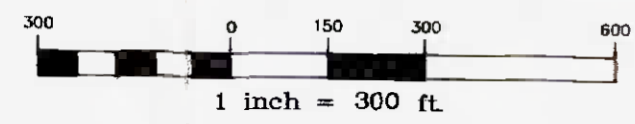
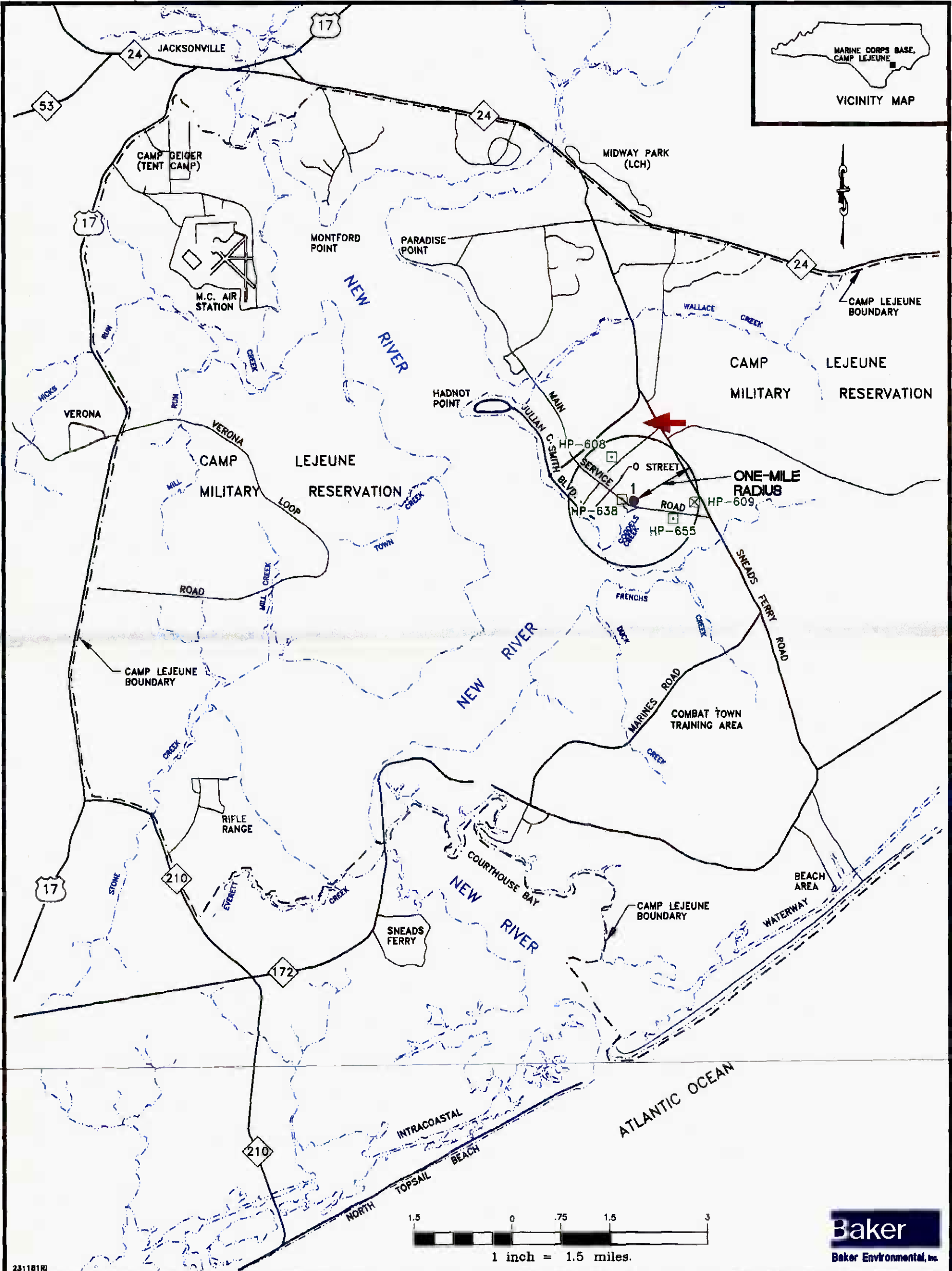

FIGURE 4-8
 BIOHABITAT MAP
 SITE 1 - FRENCH CREEK LIQUIDS DISPOSAL AREA
 REMEDIAL INVESTIGATION CTO-0231
 MARINE CORPS BASE, CAMP LEJEUNE
 NORTH CAROLINA

01499016Y



231181R

Baker
Baker Environmental, Inc.

LEGEND	
1	SITE AND SITE NUMBER
HP-638	POTABLE WATER SUPPLY WELL CURRENTLY OUT OF SERVICE
HP-609	POTABLE WATER SUPPLY WELL CURRENTLY IN SERVICE
➔	APPROXIMATE GROUNDWATER FLOW DIRECTION

FIGURE 4-9
 POTABLE WATER SUPPLY WELLS WITHIN
 ONE-MILE RADIUS OF SITE 1
 REMEDIAL INVESTIGATION CTO-0231
 MARINE CORPS BASE, CAMP LEJEUNE
 NORTH CAROLINA

01499117Y

5.0 NATURE AND EXTENT OF CONTAMINATION

This section presents the analytical findings from the RI performed at OU No. 7, Site 1. The objective of this section is to characterize the nature and extent of contamination at Site 1. The characterization of contaminants at Site 1 was performed through environmental sample collection and laboratory analysis of soil and groundwater media. Appendices F through L present the Field Duplicate Summaries, TCLP Results, Engineering Parameter Results, Quality Assurance and Quality Control Summaries, Sampling Summaries, Data and Frequency Summaries, and Statistical Summaries for the various media at Site 1.

5.1 Data Quality

The entire data set generated during the RI was submitted for third-party data validation to Heartland Environmental Services, Inc. Procedures stipulated by the National Functional Guidelines for Organic (USEPA, 1991a) and Inorganic (USEPA, 1988) Analyses were adhered to during the validation process. Validation of the analytical data, through established procedures, served to reduce the inherent uncertainties associated with its usability. Data qualified as "J" were retained as estimated. Estimated analytical results within a data set are common and considered to be usable by the USEPA. Data may be qualified as estimated for several reasons including an exceedance of holding times, high or low surrogate recovery, or intra-sample variability. In addition, values may be assigned an estimated "J" qualifier if the reported value is below the Contract Required Detection Limit (CRDL) or the Contract Required Quantitation Limit (CRQL). Data assigned a rejected "R" qualifier were excluded from the usable data set.

The entire Site 1 data set included analyses for over 23,000 separate contaminants. Only 363 of those analyses, less than two percent, were rejected as unusable. Typically, a fraction or specific contaminants within a number of fractions were rejected for reasons such as low surrogate recovery or the presence of compounds in continuing calibrations with differences greater than 90 percent. In one case, the semivolatile analyses of a groundwater sample from monitoring well 1-GW14 exceeded the extraction holding time. Under these conditions positive results were designated with "J" (i.e., estimated) qualifiers and all nondetects were assigned the "R" (i.e., rejected) qualifier. Table 5-1 provides a summary of all rejected Site 1 data.

Additional data qualifiers were employed during the validation of data. The "NJ" qualifier denotes that a compound was tentatively identified, but the reported value may not be accurate or precise. Compounds which were not detected and had inaccurate or imprecise quantitation limits were assigned the "UJ" qualifier.

5.1.1 Data Management and Tracking

The management and tracking of data from the time of field collection to receipt of the validated electronic analytical results is of primary importance and reflects the overall quality of analytical results. Field samples and their corresponding analytical tests were recorded on the chain-of-custody sheets, which have been provided in Appendix C. The chain-of-custody forms were checked against the Field Sampling and Analysis Plan (Baker, 1993) to determine if all designated samples were collected for the appropriate parameters. Upon receipt of the laboratory results, a comparison to the field information was made to determine if each sample received by the laboratory was analyzed for the correct parameters. Similarly, the validated information was

compared to the laboratory information as a final check. In summary, the tracking information was used for the following reasons:

- Identify sample discrepancies between the analysis plan and the field investigation
- Verify that the laboratory received all samples and analyzed for the correct these parameters
- Verify that the data validator received a complete data set
- Ensure that a complete data set was available for each media of concern prior to entering results into the database

5.2 Non-Site Related Analytical Results

Many of the organic and inorganic constituents detected in soil and groundwater at Site 1 are attributable to non-site related conditions or activities. Two primary sources of non-site related results include laboratory contaminants and naturally-occurring inorganic contaminants. In addition, non-site related operational activities and conditions may contribute to "on-site" contamination. A discussion of non-site related analytical results for Site 1 is provided in the following subsections.

5.2.1 Laboratory Contaminants

Blank samples provide a measure of contamination that has been introduced into a sample set during the collection, transportation, preparation, and/or analysis of samples. To remove non-site related contaminants from further consideration, the concentrations of chemicals detected in blanks were compared with concentrations of the same chemicals detected in environmental samples.

Common laboratory contaminants (i.e., acetone, 2-butanone, chloroform, methylene chloride, toluene, and phthalate esters) were considered as positive results only when observed concentrations exceeded ten times the maximum concentration detected in any blank. If the concentration of a common laboratory contaminant was less than ten times the maximum blank concentration, then it was concluded that the chemical was not detected in that particular sample (USEPA, 1989). The maximum concentrations of detected common laboratory contaminants in blanks were as follows:

- | | |
|-------------------------------|----------|
| ● Acetone | 38 µg/L |
| ● Methylene Chloride | 13 µg/L |
| ● bis-(2-Ethylhexyl)phthalate | 120 µg/L |
| ● 2-Butanone | 7 µg/L |
| ● 2-Hexanone | 5 µg/L |
| ● Di-n-octylphthalate | 41 µg/L |

Blanks containing organic constituents that were not considered common laboratory contaminants (i.e., all other TCL compounds) were considered as positive results only when observed concentrations exceeded five times the maximum concentration detected in any blank (USEPA, 1989a). All TCL compounds at less than five times the maximum level of contamination noted in any blank were considered to be not detected in that sample. The maximum concentrations of all other detected blank contaminants were as follows:

- Chloromethane 10 µg/L
- Bromomethane 9 µg/L
- Toluene 2 µg/L

A limited number of solid environmental samples that exhibited high concentrations of tentatively identified compounds (TICs) underwent an additional sample preparation. Medium level sample preparation provides a corrected Contract Required Quantitation Limit (CRQL) based on the volume of sample used for analysis. The corrected CRQL produces higher detection limits than the low level sample preparation. A comparison to laboratory blanks used in the medium level preparation was used to evaluate the relative amount of contamination within these samples.

5.2.2 Naturally-Occurring Inorganic Contaminants

In order to differentiate between inorganic contamination related to site operations and naturally-occurring inorganic contaminants in site media, the results of the sample analyses were compared to information regarding background conditions at MCB, Camp Lejeune. The following guidelines were used for each media:

- Soil: MCB, Camp Lejeune Background Soil Samples
- Groundwater: MCB, Camp Lejeune Background Groundwater Samples

The following subsections address the various comparison criteria used to evaluate the analytical results of the soil and groundwater samples collected at Site 1.

5.2.2.1 Soil

In general, chemical-specific ARARs are not available for soil. As a result, base-specific background concentrations have been compiled from a number of locations throughout MCB, Camp Lejeune to evaluate reference levels of inorganic contaminants in the surface and subsurface soil.

Organic contaminants, unlike inorganic contaminants, are not naturally-occurring. Therefore, it is probable that all organic contaminants detected in the surface and subsurface soils are attributable to activities that have or are currently taking place within and surrounding the study area. Typical background concentration values for inorganic contaminants in soils at MCB, Camp Lejeune are presented in Appendix M. These ranges are based on analytical results of background samples collected in areas not known to have been impacted by operations or disposal activities adjacent to Sites 1, 2, 6, 28, 30, 41, 69, 74, and 78 (refer to Figure 1-2 for site locations throughout MCB, Camp Lejeune). In subsequent sections, which discuss the analytical results of samples collected during the soil investigation, only those inorganic contaminants with concentrations exceeding these ranges will be considered.

In general, background soil samples have been collected outside the known boundaries of those sites listed above and in areas with similar soil types. According to the SCS Soil Survey, the greatest portion of MCB, Camp Lejeune is underlain by a number of similar soil units. Soils found on this portion of the coastal plain are moderately to strongly acidic in nature and are classified under the USCS as SM, SM-SP (i.e., fine sand or loamy fine sand) Section 3.2 provides the locations of background soil borings completed at Site 1 during this investigation.

5.2.2.2 Groundwater

Unlike soil, chemical-specific ARARs are available for evaluation of groundwater analytical results. In the subsequent sections, which address the analytical results of samples collected during the groundwater investigation, only those inorganic parameters with concentrations exceeding applicable State or Federal regulations will be discussed. In order to supplement comparison criteria, a number of base-specific background (i.e., upgradient) samples were compiled as part of a study to evaluate levels of inorganic contaminants in groundwater at MCB, Camp Lejeune (refer to Appendix M).

Groundwater samples were analyzed for total and dissolved (i.e., "filtered") inorganic parameters. Concentrations of dissolved inorganics were found to be generally lower than total inorganics for each sample, particularly for metals such as chromium, iron, lead, and manganese. A 0.45-micron filter was used in the field to remove small particles of silt and clay that would otherwise be dissolved during sample preservation, yielding higher concentrations of inorganic contaminants. The total metal analyses from unfiltered samples, thus reflect the concentrations of inorganics in the natural lithology and inorganic contaminants dissolved in the groundwater.

Relatively high concentrations of metals in unfiltered groundwater are not considered abnormal, based on experience gained from several other studies at MCB, Camp Lejeune (see Appendix M). The difference between the two analytical results (i.e., total and filtered) is important in terms of understanding and separating naturally-occurring elements (e.g., lead) from contamination by site operations (e.g., lead in gasoline).

USEPA Region IV requires that unfiltered inorganic concentrations be used in evaluating ARARs and risk to human health and the environment. In the subsequent sections, which discuss the groundwater sample analytical results, both total and dissolved inorganics (which exceed applicable Federal or State limits) will be presented and discussed.

Groundwater in the MCB, Camp Lejeune area is naturally rich in iron and manganese. Iron and manganese concentrations (i.e., total and filtered) in groundwater at MCB, Camp Lejeune often exceed the NCWQS of 300 and 50 µg/L, respectively. Elevated levels of iron and manganese, at concentrations above the NCWQS, were reported in samples collected from a number of base potable water supply wells which are installed at depths greater than 162 feet bgs. (Greenhorne and O'Mara, 1992). Iron and manganese concentrations from several wells at Site 1 exceeded the NCWQS but fell within the range of concentrations for samples collected elsewhere at MCB, Camp Lejeune. There is no record of any historical use of iron or manganese at Site 1. In light of this, it is assumed that iron and manganese are naturally-occurring inorganic contaminants in groundwater, and their presence is not attributable to site operations.

5.3 Analytical Results

This section presents the results of the soil and groundwater investigations performed at Site 1. A summary of site contamination, by media, is provided in Table 5-2.

5.3.1 Soil Investigation

Unique sample notations were employed to identify soil sampling locations and sample depths at Site 1. Samples designated by "S" were collected from the southern portion of the site. The "N" designation was assigned to samples obtained from the northern portion of the site. Samples designated with the prefix "GW" were collected from monitoring well pilot test borings. The suffix "DW" after the monitoring well number indicates that the sample was obtained from a deep monitoring well installation. The following suffix designations refer to the depth at which a sample was obtained:

00	-	ground surface to 12 inches bgs
01	-	1 to 3 feet bgs
02	-	3 to 5 feet bgs
03	-	5 to 7 feet bgs
04	-	7 to 9 feet bgs
05	-	9 to 11 feet bgs

Surface soil positive detection summaries for organic and inorganic contaminants are presented in Tables 5-3 and 5-4, respectively. Positive detection summaries of organic contaminants in subsurface soils are presented in Table 5-5; summaries for inorganic contaminants are provided in Table 5-6. Soil samples collected at Site 1 were analyzed for full TCL organics and TAL inorganics using CLP protocols and Level IV data quality. In addition, the majority of soil samples underwent analyses for total petroleum hydrocarbons (TPH). Soil samples obtained from monitoring well test borings were also analyzed for full TCL organics and TAL inorganics.

5.3.1.1 Surface Soil

A total of 14 surface soil samples were collected at Site 1. Due to asphalt, concrete, and gravel overburden material within the suspected disposal areas, a number of surface soil samples, intended for collection, were not retained for analysis (i.e., sample from ground surface to 1.0 foot). Subsurface soil samples were collected, however, from directly below the overburden material where present. As indicated on Table 5-2, volatile, semivolatile, or PCB organic compounds were not detected in surface soils at Site 1. In addition, no TPH compounds were detected in any of the surface soil samples. However, pesticides were detected at low concentrations in four surface soil samples (see Table 5-2).

Eighteen of 23 TAL inorganics were detected in surface soils at Site 1 (cobalt, mercury, selenium, silver, and thallium were not detected). The concentrations of inorganics were within one order of magnitude or less than base-specific (i.e., MCB, Camp Lejeune) background levels for surface soil (refer to Appendix M for base-specific inorganic background concentrations). Table 5-2 provides a summary of the priority pollutant inorganic contaminants found within soil samples at Site 1. Priority pollutant metals are a subset of TCL metals which include antimony, arsenic, beryllium, cadmium, chromium, copper, lead, mercury, nickel, selenium, silver, thallium, and zinc.

5.3.1.2 Subsurface Soil

A total of 110 subsurface (i.e., greater than one-foot bgs) soil samples from Site 1 were submitted for laboratory analysis. The results indicate the presence of both organic and inorganic contaminants. The VOCs acetone, trichloroethene, 1,1,2,2 - trichloroethane, and toluene were each

detected once, in four separate soil samples (see Table 5-2). No TPH compounds were detected in any of the subsurface soil samples.

The polynuclear aromatic hydrocarbons (PAHs) phenanthrene, fluoranthene, and pyrene were identified in sample 1-N-SB36-06. The SVOCs 4-nitrophenol and di-n-butylphthalate were also detected once within the sample set at sample locations 1-S-SB01-08 and 1-N-SB33-04, respectively. The common laboratory contaminant bis(2-ethylhexyl)phthalate (BEHP) was detected (i.e., exceeded 10 times the maximum blank concentration) in a total of eight subsurface soil samples.

A total of eight organic pesticide compounds were detected in subsurface soils at Site 1. In general, positive detections of pesticides were limited to the northern portion of the study area. Two PCB contaminants were each detected once from separate borings at Site 1. Aroclor 1254 was detected at a concentration of 18 J $\mu\text{g}/\text{kg}$ from sample 1-GW16-04 and Aroclor 1260 was detected at a concentration of 1,300 $\mu\text{g}/\text{kg}$ from sample 1-N-SB35-01.

A total of 21 TAL inorganics were detected in subsurface soils at Site 1 (beryllium and thallium were not detected). All concentrations of inorganic contaminants were within one order of magnitude or less than base-specific background levels for subsurface soil (refer to Appendix M). Table 5-2 provides a summary of the priority pollutant inorganic contaminants found within soil samples at Site 1.

5.3.1.3 Summary

The pesticides dieldrin, 4,4'-DDE, 4,4'-DDD, 4,4'-DDT, endrin aldehyde, alpha-chlordane, and gamma-chlordane appear to be the most prevalent contaminants within soils at Site 1. Each of the six pesticides was detected, at low concentrations, in at least two of the 124 soil samples. The pesticide 4,4'-DDT was the most prevalent, with 10 positive detections ranging from 1.6 J to 18 J $\mu\text{g}/\text{kg}$. The highest pesticide concentration was that of 4,4'-DDE at 120 $\mu\text{g}/\text{kg}$. In general, pesticide detections were concentrated in the northern portion of the study area, and in particular, among soil borings 1-N-SB22, 1-N-SB26, 1-N-SB34, 1-N-SB35, 1-N-SB37, and 1-GW17. The positive detections are, for the most part, limited to soil samples collected from less than seven feet below ground surface.

Aroclor 1254 and 1260 were each detected once within the subsurface sample set. Aroclor 1254 was detected in a sample from a monitoring well test boring on the southern portion of the site, at a concentration of 18 J $\mu\text{g}/\text{kg}$. Aroclor 1260 was identified at a concentration, 1,300 $\mu\text{g}/\text{kg}$, in boring 1-N-SB35. This boring is located near the center of the northern disposal area.

Volatile compounds were not found in surface soils and were detected in only four subsurface samples scattered throughout the site. The VOC acetone was detected in one sample from the southern portion of the study area. However, the data suggest that acetone may have been an artifact of decontamination. Trichloroethene and toluene were detected at very low concentrations in samples also from the northern central portion of the study area.

Semivolatile compounds were not encountered in surface soils, but were detected in a number of subsurface samples. Most notable among the SVOCs detected, were three PAH compounds and di-n-butylphthalate. The positive detections of these compounds were located near the northern central portion of the site. The random distribution of BEHP suggests the occurrence of laboratory

contamination, although detected in excess of ten times the maximum blank concentration of 120 µg/kg.

Based on a comparison of base-specific background levels, positive detections of inorganics at Site 1 do not appear to be the result of past disposal practices.

5.3.2 Groundwater Investigation

The groundwater investigation at Site 1 consisted of a complete round of samples obtained from each of the 16 shallow and two deep monitoring wells and the base water supply well, HP-638. Groundwater samples collected at Site 1 were analyzed for TCL volatile and semivolatile organics and TAL inorganics, both total and dissolved fractions, using CLP protocols and Level IV data quality. (Dissolved or filtered TAL inorganic results are presented in this report for comparative purposes only. These results were not used to evaluate site-related risks or to determine compliance with groundwater standards.) In addition to TCL volatile and semivolatile results, a limited number of shallow and deep groundwater samples were also analyzed for pesticide and PCB fractions.

A second, supplemental, sampling round was performed on 17 of the 18 shallow and deep monitoring wells and the water supply well. The existing shallow monitoring well 1-GW14 was dry at the time of the second sampling round; and therefore, no sample was collected. The analytical results from both sampling rounds are provided in the following subsections. Positive detection summaries of organic compounds from both the first and second sampling rounds are presented in Tables 5-7 and 5-10, respectively. Inorganic results from groundwater analyses are provided in Tables 5-8 and 5-11. In addition, Tables 5-9 and 5-12 present the positive detection summaries for dissolved inorganic contaminants. A comparison of analytical results from both rounds of groundwater samples is provided in Table 5-13.

5.3.2.1 Shallow Groundwater

Round One

A total of 16 shallow groundwater samples from Site 1 were submitted for laboratory analysis. The samples were collected from the uppermost portion of the surficial aquifer (i.e., the water table). As indicated in Table 5-2, semivolatile fractions were not detected in any of the shallow groundwater samples. In addition, pesticide and PCB contaminants were not detected in the four shallow groundwater samples (i.e., samples 1-GW04, 1-GW06, 1-GW11, and 1-GW17) submitted for those analyses. However, the analytical results from shallow groundwater samples indicate the presence of VOCs and metals.

Four shallow monitoring wells, located on the northern portion of the study area, had positive detections of VOCs. Trichloroethene, 1,2-dichloroethene, vinyl chloride, and total xylenes were each detected at least once in the shallow groundwater. Table 5-2 provides a summary of volatile groundwater contamination.

TAL metals, both total and dissolved fractions, were detected in each of the 16 shallow monitoring wells at Site 1. Complete positive detection summaries for total and dissolved metals are provided on Tables 5-8 and 5-9, respectively. Each of the 23 TAL total metals was detected within at least one groundwater sample at Site 1. Fifteen of 23 TAL dissolved metals were also detected within at least one of the 16 groundwater samples (beryllium, cadmium, chromium, mercury, selenium,

silver, and vanadium were not detected). A total of 13 TAL total metals were detected at concentrations in excess of the MCL or NCWQS standards, based on total metal analysis. Although federal and state standards apply strictly to total metal results, TAL dissolved metal analyses were employed as a basis of comparison. Dissolved antimony, iron, manganese, and thallium were each detected in at least one groundwater sample in excess of regulatory limits.

Round Two

During the second sampling round, a total of 15 shallow groundwater samples from Site 1 were submitted for laboratory analysis of total and dissolved metals, total dissolved solids (TDS), and total suspended solids (TSS). Additionally, four of the 15 groundwater samples were also submitted for volatile organic analyses. Groundwater samples were obtained from monitoring wells that exhibited organic contamination from the first sampling round and from those wells with total metal concentrations in excess of water quality standards.

The volatile compounds trichloroethene, 1,1-dichloroethene, 1,2-dichloroethene, vinyl chloride, and total xylenes were each detected at least once in the shallow groundwater. The second round of VOC data was used to confirm the presence of organic compounds in those wells that exhibited contamination during the first sampling round. Table 5-2 provides a summary of volatile groundwater contamination.

Total and dissolved TAL metal fractions were detected in each of the 15 shallow groundwater samples submitted for analysis from Site 1. A groundwater sample was not obtained from existing monitoring well 1-GW14. Positive detection summaries for round two, total and dissolved metal analyses, are provided in Tables 5-11 and 5-12, respectively. Thirteen of the 23 TAL total metals were detected within at least one shallow groundwater sample at Site 1 (antimony, beryllium, cadmium, chromium, copper, nickel, selenium, silver, thallium, and zinc were not detected). Fifteen of 23 TAL dissolved metals were also detected within at least one of the 15 groundwater samples (aluminum, antimony, beryllium, cadmium, chromium, selenium, thallium, and zinc were not detected). Two TAL metals were detected at concentrations in excess of the NCWQS standard, based on total metal analyses. Iron and manganese were detected at concentrations which exceeded the NCWQS in nine and fifteen groundwater samples, respectively. Table 5-2 provides a summary of total metal contaminants that exceeded either the MCL or NCWQS. Additionally, Table 5-13 provides a comparison of round one versus round two results.

5.3.2.2 Deep Groundwater

Round One

A total of three groundwater samples were obtained from the deep aquifer (i.e., the Castle Hayne aquifer) at Site 1. Volatile compounds were not detected in any of the three samples from the deep aquifer. However, the semivolatile compounds phenol and diethylphthalate were detected in deep well 1-GW17DW at estimated concentrations of 6 J and 1 J $\mu\text{g/L}$, respectively. One of the deep groundwater samples, from the water supply well HP-638, was submitted for pesticide and PCB analysis. No pesticide or PCB contaminants were detected.

TAL metals, both total and dissolved fractions, were detected in both of the deep monitoring wells and the supply well at Site 1. Thirteen of the 23 TAL total metals were detected within at least one of the deep groundwater samples. Eight of 23 TAL dissolved metals were also detected within at

least one of the three deep groundwater samples. Only the total metals antimony and iron were detected at concentrations in excess of the MCL (secondary MCL for iron) or NCWQS drinking water standards. As a relative basis of comparison, TAL dissolved metals results were compared to TAL total metal results. In the case of deep groundwater samples from Site 1, no dissolved metals were detected in excess of MCL or NCWQS standards.

Round Two

Samples from the two deep groundwater monitoring wells and the base supply well at Site 1 were submitted for TAL total and dissolved metal analyses as part of the second sampling round. A sample from well 1-GW17DW was also submitted for semivolatile analysis. However, no semivolatile compounds were detected in the sample.

TAL metals, both total and dissolved fractions, were detected in each of the three deep groundwater samples. Eight of the 23 TAL metals, both total and dissolved, were detected at least 1 of the deep groundwater samples. Only the total metal iron was detected at a concentration in excess of NCWQS drinking water standards. Iron was detected in a sample from the supply well, HP-638, at a concentration of 712 µg/L, which exceeds the NCWQS of 300 µg/L.

5.3.2.3 Summary

Inorganic contaminants were the most prevalent among potential contaminants in groundwater at Site 1 and were found distributed throughout the site. Concentrations of TAL total metals were generally higher in shallow groundwater samples than in samples obtained from the deeper aquifer. Iron and manganese were detected at concentrations which exceeded the NCWQS drinking water standards in 9 and 15 samples, respectively, obtained during the second sampling round. Barium, calcium, magnesium, potassium, and sodium were detected in each of the 18 shallow and deep groundwater samples. Furthermore, Round Two results yielded significantly lower metal concentrations as a result of the low flow sampling technique. This technique reduced the amount of suspended solids in the samples and, thus providing a true representation of groundwater.

Positive detections of VOCs and SVOCs in groundwater were limited to the northern portion of the study area. In general, VOC analytical results from the first and second sampling events correlated. The volatile compound trichloroethene was detected in samples obtained from three of the shallow monitoring wells. The maximum trichloroethene concentration, 27 µg/L, was detected within the sample from monitoring well 1-GW17, located in the central northern portion of the study area. The volatile compounds 1,2-dichloroethene and 1,1-dichloroethene were observed at maximum concentrations of 21 and 2 J µg/L, respectively. The maximum 1,2-dichloroethene and 1,1-dichloroethene concentrations were detected in a sample obtained from well 1-GW10, located to the west of the suspected northern disposal area. Vinyl chloride was detected at an estimated concentration of 4 J µg/L, also from well 1-GW10. Xylenes were detected in a shallow groundwater sample from well 1-GW12, at a maximum concentration of 19 µg/L. The SVOCs phenol and diethylphthalate were detected during the first sampling round only in a sample from well 1-GW17DW, at concentrations of 6 J and 1 J µg/L, respectively.

5.4 Extent of Contamination

This section addresses the extent of contamination within soil and groundwater at OU No. 7, Site 1.

5.4.1 Extent of Soil Contamination

Positive detections of organic compounds in surface and subsurface soil samples collected at Site 1 are depicted on Figures 5-1 and 5-2, respectively. As addressed in Section 5.3.1, none of the 124 samples submitted for analysis had a TAL metal concentration greater than one order of magnitude above base-specific background levels (see Appendix M). The range of TAL metal concentrations in soil is not indicative of metal disposal operations, and therefore the extent of metals contamination in soils at Site 1 will not be addressed.

5.4.1.1 Volatiles

Volatile compounds within soils at Site 1 do not appear to be the result of widespread disposal activities. VOCs were positively detected in only 4 of the 124 soil samples collected at Site 1. The positive detections were distributed throughout various locations at Site 1. A pilot test boring for well 1-GW17 and boring 1-N-SB32, both located in the central northern portion of the study area, had very low concentrations (i.e., less than 3 $\mu\text{g}/\text{kg}$) of toluene and trichloroethene, respectively. The extent of volatile contaminants is limited to subsurface soil, due to the presence of asphalt and concrete overburden which can serve as barriers for migration. The central portion of northern disposal area also exhibited levels of volatile compounds in groundwater. Given the limited extent of volatile contamination at Site 1, the presence of VOCs may be related to previous or ongoing maintenance activities.

5.4.1.2 Semivolatiles

The dispersion and concentrations of SVOCs at Site 1 do not suggest widespread disposal of these compounds. Three PAH compounds were identified at low concentrations within a subsurface sample obtained from boring 1-N-SB36, located near the central northern portion of the site, PAHs were not identified in any of the surrounding borings, however. As Figure 5-2 depicts, the compound BEHP was detected in samples throughout the site at concentrations indicative of laboratory contamination. The limited occurrence of SVOCs in soil appears to be isolated in those samples obtained from borings indicated on Figure 5-2.

5.4.1.3 Pesticides

Positive detections of pesticides were observed in both surface and subsurface soil samples. A majority of pesticide detections were observed in the central portion of the northern study area. As Figures 5-1 and 5-2 depict, the detected pesticide levels were low (i.e., less than 120 $\mu\text{g}/\text{kg}$) and most likely the result of routine pesticide application. A majority of the pesticide detections were from subsurface samples (i.e., samples obtained from greater than one foot bgs). Soil samples obtained from depths of one to seven feet bgs, had the highest levels of pesticides.

From the 1940s to the early 1980s, much of the surface area at Site 1 was without asphalt or concrete. Typically, open storage lots require constant maintenance and addition of surface material to offset erosion and compaction. The continued maintenance and addition of asphalt, concrete, and gravel may help to explain the presence of pesticides within subsurface soil samples. The frequency and overall concentration of pesticides in soil, however, does not represent pesticide disposal activities.

5.4.1.4 Polychlorinated Biphenyls

Two positive detections of PCBs were observed in separate subsurface soil samples. Aroclor 1254 was identified at an estimated concentration of 18 J $\mu\text{g}/\text{kg}$ in a subsurface soil sample from the southern portion of the site. Aroclor 1260 was detected at a concentration of 1,300 $\mu\text{g}/\text{kg}$ in a subsurface sample from the central northern portion of the site. At one time it was not uncommon to use oil, possibly containing PCBs, as a dust suppressor and to apply pesticides. The localized detection of both pesticides and PCBs at location 1-N-SB35 suggests that an isolated event may have resulted in positive detections of these compounds. In either case, soil borings located immediately adjacent to the two borings with PCBs do not exhibit PCB contamination. The results of soil analyses are not characteristic of PCB disposal activities.

5.4.2 **Extent of Groundwater Contamination**

Positive detections of organic compounds in shallow and deep groundwater samples collected at Site 1 are depicted on Figure 5-3. As addressed in Section 5.3.2, pesticide and PCB contaminants were not detected in any of the four shallow or one deep groundwater samples submitted for analysis. Based upon the results of those analyses, the extent of pesticide and PCB contamination in groundwater will not be addressed.

5.4.2.1 Volatiles

Positive detections of volatile compounds were limited to shallow groundwater samples obtained from wells located on the northern portion of the study area. The lack of positive VOC detections in samples obtained from the deep aquifer suggest that these contaminants have not migrated from the surficial aquifer. The highest concentration of a single VOC, trichloroethene at 27 $\mu\text{g}/\text{L}$, was detected in well 1-GW17. Monitoring well 1-GW17 lies within the central portion of the northern suspected disposal area, as depicted on Figure 5-3. Trichloroethene was also detected in two other shallow wells, 1-GW10 and 1-GW11. These two wells, however, are located off-site, beyond the northwestern perimeter of the suspected disposal area. The lack of positive VOC detections in wells 1-GW02, 1-GW03, and 1-GW15, which are hydraulically downgradient of 1-GW17, suggests that the extent of VOC contamination in groundwater is limited to the observed locations. Moreover, the limited extent of VOC contamination (i.e., in both soil and groundwater) suggests that the source may have resulted from spillage of small quantities rather than from long-term disposal or buried containers.

Bordering the suspected disposal area to the north is a vehicle training area. Operation and maintenance of mechanized vehicles throughout the training area may have resulted in unintentional spillage of these compounds. The concentrations of trichloroethene and 1,2-dichloroethene may be related to off-site sources of contamination observed in this area, not to previous or ongoing activities at Site 1.

5.4.2.2 Semivolatiles

Samples from the 16 shallow and 2 deep groundwater monitoring wells and the supply well from Site 1 were submitted for analysis of semivolatile compounds. The SVOCs phenol and diethylphthalate were detected in one deep groundwater sample, 1-GW17DW (located within the central portion of the northern study area), obtained during the first sampling round. Estimated concentrations of phenol and diethylphthalate were 6 J and 1 J $\mu\text{g}/\text{L}$, respectively. Soil analytical

results from this location did not indicate the presence of SVOCs. Similar low concentrations of phenols were detected in shallow groundwater samples obtained during the Confirmation Study. However, the entire area is actively used for vehicle maintenance and storage, which may account for the presence of contamination at this low level.

5.4.2.3 Metals

Inorganic contaminants were detected in each of the 19 groundwater samples submitted for analysis from Site 1. Iron and manganese were the only TAL total metals detected at levels in excess of either Federal MCL or North Carolina WQS regulatory limits. Positive detections of both iron and manganese were distributed throughout the site, indicative of natural site conditions rather than disposal activities. In addition, concentrations of all TAL metals in groundwater at Site 1 do not appear to represent a particular trend or pattern of dispersal.

The distribution of metal concentrations does not appear to be related to groundwater flow direction. The decrease of total metal concentrations between the first and second sampling rounds was the result of modified sample acquisition procedures. Elevated total metal observations have been recorded at other MCB, Camp Lejeune sites and are likely the consequence of loose surficial soils. During the resampling, a low flow purge method was utilized to minimize the presence suspended solids or colloids in samples that are associated with the surficial soils (refer to Section 3.3.5 for Groundwater Sampling Procedures). The resulting data set yielded a more accurate assessment of existing conditions. The DoN is currently evaluating the presence and distribution of total and dissolved metals in groundwater throughout the facility. The draft report "Evaluation of Metals in Groundwater at MCB, Camp Lejeune, North Carolina," (Baker, 1994) addressed the pervasiveness of total metals in groundwater and identified a number of potential causes. Preliminary conclusions of the study support the opinion that total metal concentrations in groundwater are due more to geologic conditions (i.e., naturally occurring concentrations and unconsolidated soils) and sample acquisition methods than to actual metal concentrations in the surficial aquifer.

SECTION 5.0 TABLES

TABLE 5-1

**SUMMARY OF REJECTED DATA
SITE 1, FRENCH CREEK LIQUIDS DISPOSAL AREA
REMEDIAL INVESTIGATION, CTO-0231
MCB, CAMP LEJEUNE, NORTH CAROLINA**

Media	Sample No.	Chemical/Category	Comment
Soils	1-S-SB01-08	TCL Pesticide and PCB Fraction	3
	1-S-SB08-07D	TCL Pesticide and PCB Fraction	3
	1-S-SB15-06	TCL Semivolatile Fraction	3
	1-N-SB20-05	Di-n-octylphthalate	1
	1-N-SB21-07	Di-n-octylphthalate	1
	1-N-SB24-07	Di-n-octylphthalate	1
	1-N-SB26-04D	Di-n-octylphthalate	1
	1-N-SB32-04	TCL Semivolatile Fraction	3
	1-N-SB32-07	TCL Semivolatile Fraction	3
Groundwater	1-GW01-02	Mercury (Total) Silver (Total)	3
	1-GW01D-02	Mercury (Dissolved) Silver (Dissolved)	3
	1-GW02-02	Mercury (Total) Silver (Total)	3
	1-GW02D-02	Mercury (Dissolved) Silver (Dissolved)	3
	1-GW03-02	Mercury (Total) Silver (Total)	3
	1-GW03D-02	Mercury (Dissolved) Silver (Dissolved)	3
	1-GW04-01	4-Nitrophenol 3,3'-Dichlorobenzidine	1
	1-GW04-01D	4-Nitrophenol 3,3'-Dichlorobenzidine	1
	1-GW06-02	Mercury (Total) Silver (Total)	3
	1-GW06D-02	Mercury (Dissolved) Silver (Dissolved)	3
	1-GW07-01	4-Nitrophenol 3,3'-Dichlorobenzidine	1
	1-GW08-02	Mercury (Total) Silver (Total)	3
	1-GW08D-02	Mercury (Dissolved) Silver (Dissolved)	3
	1-GW08-01	4-Nitrophenol 3,3'-Dichlorobenzidine	1
	1-GW09-02	Mercury (Total) Silver (Total)	3
	1-GW09D-02	Mercury (Dissolved) Silver (Dissolved)	3

TABLE 5-1 (Continued)

SUMMARY OF REJECTED DATA
 SITE 1, FRENCH CREEK LIQUIDS DISPOSAL AREA
 REMEDIAL INVESTIGATION, CTO-0231
 MCB, CAMP LEJEUNE, NORTH CAROLINA

Media	Sample No.	Chemical/Category	Comment
Groundwater (Cont.)	1-GW10-01	4-Nitrophenol 3,3'-Dichlorobenzidine	1
	1-GW11-01	4-Nitrophenol 3,3'-Dichlorobenzidine	1
	1-GW11-02	Mercury (Total) Silver (Total)	3
	1-GW11-02MS	Mercury (Total) Silver (Total)	3
	1-GW11-02D	Mercury (Total) Silver (Total)	3
	1-GW11D-02	Mercury (Dissolved) Silver (Dissolved)	3
	1-GW11D-02MS	Mercury (Dissolved) Silver (Dissolved)	3
	1-GW11D-02MD	Mercury (Dissolved) Silver (Dissolved)	3
	1GW11D-02D	Mercury (Dissolved) Silver (Dissolved)	3
	1-GW12-02	Mercury (Total) Silver (Total)	3
	1-GW12D-02	Mercury (Dissolved) Silver (Dissolved)	3
	1-GW12-01	4-Nitrophenol 3,3'-Dichlorobenzidine	1
	1-GW13-02	Mercury (Total) Silver (Total)	3
	1-GW13D-02	Mercury (Dissolved) Silver (Dissolved)	3
	1-GW14-01	TCL Semivolatile Fraction	2
	1-GW16-01	2-Chloroethylvinylether	1
	1-GW16DW-01	2-Chloroethylvinylether	1

Comments:

1. Continuing calibration contained compounds with percent differences greater than 90 percent. Therefore, positive results were designated as estimated (J) and all nondetects were rejected (R).
2. Sample exceeded extraction holding time. Therefore, positive results were designated as estimated (J) and all nondetects were rejected (R).
3. Surrogate recoveries were less than 10 percent. Therefore, positive results were designated as estimated (J) and all nondetects were rejected (R).

TABLE 5-2

SUMMARY OF SITE CONTAMINATION
SITE 1, FRENCH CREEK LIQUIDS DISPOSAL AREA
REMEDIAL INVESTIGATION, CTO-0231
MCB, CAMP LEJEUNE, NORTH CAROLINA

Media	Fraction	Detected Contaminants	Comparison Criteria		Site Contamination				
			ARAR	Base Background	Min.	Max.	Max. Location	Detection Frequency	Distribution
Surface Soil	Volatiles	ND	NA	NA				0/14	
	Semivolatiles	ND	NA	NA				0/14	
	Pesticides	Dieldrin	NA	NA	4.3 J	4.3 J	1-GW17	1/14	central northern
		4-4'-DDE	NA	NA	2.2 J	4.9	1-GW17	2/14	central northern & southern
		4-4'-DDT	NA	NA	7.0 J	12	1-GW12	3/14	scattered
		Endrin aldehyde	NA	NA	3.9 NJ	3.9 NJ	1-GW17DW	1/14	central northern
	PCBs	ND	NA	NA				0/14	
	Metals (1)	Antimony	NA	0.3 - 8.0	9.0 J	11.9	1-GW11	3/14	3 exceed BB, all near pond
		Arsenic	NA	0.2 - 1.8	0.57	2.0	1-N-SB29	6/14	1 exceeds BB, scattered
		Beryllium	NA	0.03 - 0.16	0.19	0.19	1-GW07	1/14	1 exceeds BB, southern
		Cadmium	NA	0.18 - 0.58	0.62	2.0	1-GW16	3/14	3 exceed BB, southern
		Chromium	NA	0.3 - 12.5	1.5	6.4	1-GW07	13/14	none exceed BB
		Copper	NA	0.5 - 87.2	1.6	4.9	1-GW16	6/14	none exceed BB
		Lead	NA	0.5 - 142.0	1.0	23.5	1-GW16	14/14	none exceed BB
Nickel		NA	0.6 - 3.6	1.6	3	1-GW17	3/14	none exceed BB	
Zinc		NA	0.3 - 28.3	3.5	26.9	1-GW08	9/14	none exceed BB	
Subsurface Soil	Volatiles	Acetone	NA	NA	490 J	490 J	1-S-SB07	1/110	southern
		Trichloroethene	NA	NA	3 J	3 J	1-N-SB32	1/110	west of Building FC-120
		1,1,2,2 - TCA	NA	NA	27	27	1-S-SB11	1/110	central southern
		Toluene	NA	NA	1 J	1 J	1-GW17DW	1/110	central northern
	Semivolatiles	4-Nitrophenol	NA	NA	930	930	1-S-SB01	1/110	along Main Service Road, southern
		Phenanthrene (PAH)	NA	NA	47 J	47 J	1-N-SB36	1/110	north of Building FC-120
		di-n-butylphthalate	NA	NA	74 J	74 J	1-N-SB33	1/110	north of Building FC-120
		Fluoranthene (PAH)	NA	NA	110 J	110 J	1-N-SB36	1/110	north of Building FC-120
		Pyrene (PAH)	NA	NA	86 J	86 J	1-N-SB36	1/110	north of Building FC-120
		BEHP	NA	NA	36 J	8,700	1-N-SB26	45/110	scattered

TABLE 5-2 (Continued)

SUMMARY OF SITE CONTAMINATION
 SITE 1, FRENCH CREEK LIQUIDS DISPOSAL AREA
 REMEDIAL INVESTIGATION, CTO-0231
 MCB, CAMP LEJEUNE, NORTH CAROLINA

Media	Fraction	Detected Contaminants	Comparison Criteria		Site Contamination				
			ARAR	Base Background	Min.	Max.	Max. Location	Detection Frequency	Distribution
Subsurface Soil (Continued)	Pesticides	Dieldrin	NA	NA	7.1 J	39 J	1-N-SB26	2/110	central northern
		4,4'-DDE	NA	NA	11	120	1-N-SB26	2/110	central northern
		Endosulfan II	NA	NA	55	55	1-N-SB35	1/110	north of Building FC-120
		4,4'-DDD	NA	NA	2.2 J	28 J	1-N-SB26	2/110	scattered, northern
		4,4'-DDT	NA	NA	1.6 J	18 J	1-N-SB35	7/110	central northern, 1 southern
		Endrin aldehyde	NA	NA	24 NJ	24 NJ	1-N-SB35	1/110	north of Building FC-120
		alpha-Chlordane	NA	NA	4.2 NJ	9.2 NJ	1-N-SB37	2/110	northern
		gamma-Chlordane	NA	NA	2.5 NJ	2.9 NJ	1-N-SB26	2/110	central northern
	PCBs	Aroclor 1254	NA	NA	18 J	18 J	1-GW16	1/110	central, southern portion
		Aroclor 1260	NA	NA	1,300	1,300	1-N-SB35	1/110	north of Building FC-120
	Metals (1)	Antimony	NA	0.4 - 6.9	6.1 J	7.8 J	1-N-SB36	7/110	6 exceed BB, scattered
		Arsenic	NA	0.03 - 1.50	0.6	5.6	1-GW16DW	58/110	21 exceed BB, scattered
		Cadmium	NA	0.17 - 1.20	0.62	1.1	1-S-SB13	5/110	none exceed BB
		Chromium	NA	0.7 - 10.5	1.5	17.5	1-GW10	109/110	6 exceed BB, scattered
		Copper	NA	0.5 - 6.6	1.1	5	1-N-SB26	42/110	none exceed BB
		Lead	NA	0.5 - 11.5	1.3	60.4 J	1-N-SB26	101/110	6 exceed BB, northern
		Mercury	NA	0.01 - 0.68	0.06	0.34	1-S-SB01	7/110	none exceed BB
		Nickel	NA	0.6 - 4.7	1.2	4.4	1-N-SB32	40/110	none exceed BB
		Selenium	NA	0.12 - 0.55	0.81	1.5 J	1-S-SB03	2/110	2 exceed BB, northern & southern
		Silver	NA	0.18 - 1.00	1 J	1 J	1-S-SB12	1/110	does not exceed BB
Zinc	NA	0.3 - 11.6	0.63 J	78.6 J	1-S-SB01	74/110	8 exceed BB, scattered		
Groundwater	Volatiles (2)	Vinyl Chloride	NCWQS - 0.015	NA	2	4 J	1-GW10	1/19	1 exceeds ARAR, northwest
		1,1-Dichloroethene	MCL - 7	NA	2 J	2 J	1-GW10	1/19	does not exceed ARAR
		1,2-Dichloroethene	MCL - 100	NA	1 J	21	1-GW10	2/19	do not exceed ARAR
		Trichloroethene	NCWQS - 2.8	NA	1 J	27	1-GW17	3/19	2 exceed ARAR
		Xylenes (total)	NCWQS - 530	NA	3	19	1-GW12	1/19	does not exceed ARAR

TABLE 5-2 (Continued)

SUMMARY OF SITE CONTAMINATION
 SITE 1, FRENCH CREEK LIQUIDS DISPOSAL AREA
 REMEDIAL INVESTIGATION, CTO-0231
 MCB, CAMP LEJEUNE, NORTH CAROLINA

Media	Fraction	Detected Contaminants	Comparison Criteria		Site Contamination				
			ARAR	Base Background	Min.	Max.	Max. Location	Detection Frequency	Distribution
Groundwater (continued)	Semivolatiles (2)	Phenol	NA	NA	6.1 J	6.1 J	1-GW17DW	1/19	central northern portion
		Diethylphthalate	NCWQS - 5,000	NA	1.3 J	1.3 J	1-GW17DW	1/19	does not exceed ARAR
	Pesticides	ND	MCL/NCWQS	NA				0/6	
	PCBs	ND	NA	NA				0/6	
	Total	Iron	NCWQS - 300	882 - 55,300	263	29200 J	1-GW12	9/19	9 exceed ARAR, none exceed BB
	Metals (3)	Manganese	NCWQS - 50	10 - 290	2.5	1,200	1-GW11	18/19	15 exceed ARAR, 9 exceed BB

- Notes:
- Concentrations are presented in $\mu\text{g/L}$ for liquid and $\mu\text{g/Kg}$ for solids (ppb), metal concentrations for soils and sediments are presented in mg/Kg (ppm).
 - (1) Metals in both surface and subsurface soils were compared to the range of base background positive detections for priority pollutant metals only (i.e., antimony, arsenic, beryllium, cadmium, chromium, copper, lead, mercury, nickel, selenium, silver, thallium, zinc).
 - (2) Additional groundwater samples were collected from wells which exhibited concentrations of volatile and semivolatile compounds during the initial round.
 - (3) Total metals in groundwater samples were compared to the range of positive detections in upgradient wells throughout MCB, Camp Lejeune.
- ARAR - Applicable or Relevant and Appropriate Requirements
 BB - Base background (refer to Appendix M)
 BEHP - bis(2-ethylhexyl)phthalate
 NA - Not applicable
 NCWQS - North Carolina Water Quality Standard
 ND - Not detected
 MCL - Federal Maximum Contaminant Level
 PAH - Polynuclear aromatic hydrocarbon
 TCA - Tetrachloroethane

TABLE 5-3
SURFACE SOIL - POSITIVE DETECTION SUMMARY
SITE 1, FRENCH CREEK LIQUIDS DISPOSAL AREA
REMEDIAL INVESTIGATION CTO-0231
MCB, CAMP LEJEUNE, NORTH CAROLINA
TCL ORGANICS

Sample ID:	1-N-SB20-00	1-N-SB29-00	1-GW07-00	1-GW08-00	1-GW10-00	1-GW11-00	1-GW12-00	1-GW16DW-00
Sample Depth:	0-1'	0-1'	0-1'	0-1'	0-1'	0-1'	0-1'	0-1'
Date Sampled:	3/29/94	3/28/94	4/12/94	4/12/94	4/11/94	4/10/94	4/10/94	5/2/94

VOLATILES

SEMIVOLATILES

	<u>UNITS</u>								
bis(2-Ethylhexyl)phthalate	UG/KG	510	710	58 J	39 J	260 J	41 J	50 J	910

PESTICIDE/PCBs

Dieldrin	UG/KG	ND	ND	ND	ND	ND	ND	ND	ND
4,4'-DDE	UG/KG	ND	ND	ND	2.2 J	ND	ND	ND	ND
4,4'-DDT	UG/KG	ND	ND	ND	7.5	ND	ND	12	ND
Endrin aldehyde	UG/KG	ND	ND	ND	ND	ND	ND	ND	ND

UG/KG - micrograms per kilogram
 J - estimated
 ND - not detected
 NJ - tentatively identified

TABLE 5-3
SURFACE SOIL - POSITIVE DETECTION SUMMARY
SITE 1, FRENCH CREEK LIQUIDS DISPOSAL AREA
REMEDIAL INVESTIGATION CTO-0231
MCB, CAMP LEJEUNE, NORTH CAROLINA
TCL ORGANICS

Sample ID:	1-GW16-00	1-GW17DW-00	1-GW17-00
Sample Depth:	0-1'	0-1'	0-1'
Date Sampled:	4/13/94	5/5/94	4/19/94

VOLATILES

<u>SEMIVOLATILES</u>	<u>UNITS</u>			
bis(2-Ethylhexyl)phthalate	UG/KG	77 J	ND	350
 <u>PESTICIDE/PCBs</u>				
Dieldrin	UG/KG	ND	ND	4.3 J
4,4'-DDE	UG/KG	ND	ND	4.9
4,4'-DDT	UG/KG	ND	ND	7.0 J
Endrin aldehyde	UG/KG	ND	3.9 NJ	ND

UG/KG - micrograms per kilogram
 J - estimated
 ND - not detected
 NJ - tentatively identified

TABLE 5-4
SURFACE SOIL - POSITIVE DETECTION SUMMARY
SITE 1, FRENCH CREEK LIQUIDS DISPOSAL AREA
REMEDIAL INVESTIGATION CTO - 0231
MCB, CAMP LEJEUNE, NORTH CAROLINA
TOTAL METALS

Sample ID:	1-N-SB19-00	1-N-SB20-00	1-N-SB29-00	1-N-SB30-00	1-GW07-00	1-GW08-00	1-GW09-00	1-GW10-00	1-GW11-00	1-GW12-00	
Sample Depth:	0-1'	0-1'	0-1'	0-1'	0-1'	0-1'	0-1'	0-1'	0-1'	0-1'	
Date Sampled:	3/28/94	3/29/94	3/28/94	3/29/94	4/12/94	4/12/94	4/10/94	4/11/94	4/10/94	4/10/94	
	<u>UNITS</u>										
Aluminum	MG/KG	2170	2930	2010	1820	4490	2780	310	1050	2230	2140
Antimony	MG/KG	9.4 J	ND	ND	9.0 J	ND	ND	ND	ND	11.9	ND
Arsenic	MG/KG	ND	ND	2.0	ND	1.8	ND	ND	ND	ND	ND
Barium	MG/KG	7.0	6.3	6.4	6.1	11.0	10.3	1.6	2.7	5.5	3.4
Beryllium	MG/KG	ND	ND	ND	ND	0.19	ND	ND	ND	ND	ND
Cadmium	MG/KG	ND	ND	ND	ND	ND	1.2	ND	ND	ND	ND
Calcium	MG/KG	3120	24600 J	15600 J	11500 J	416	12900	128	47.5	676	ND
Chromium	MG/KG	4.4	4.2 J	4.6	4.3	6.4	2.7	ND	1.5	3.5	2.8
Copper	MG/KG	ND	ND	ND	ND	1.6	2.5	ND	1.8	ND	ND
Iron	MG/KG	1120	1330	1370	966	3060	1570	226	399	956	681
Lead	MG/KG	13.9	6.4 J	6.9	5.9	4.9	19.4	1.0	4.3	4.7	2.1
Magnesium	MG/KG	112	452	280	244	165	306	11.6	27.0	72.0	24.8
Manganese	MG/KG	5.8	7.1 J	5.2	5.5	12.4	16.4	4.9	9.1	5.5	3.1
Mercury	MG/KG	ND	ND	ND	ND	ND	ND	ND	ND	ND	ND
Nickel	MG/KG	ND	ND	ND	ND	ND	ND	ND	ND	ND	ND
Potassium	MG/KG	ND	122 J	ND	ND	143 J	66.8 J	ND	ND	ND	ND
Selenium	MG/KG	ND	ND	ND	ND	ND	ND	ND	ND	ND	ND
Sodium	MG/KG	ND	ND	ND	ND	ND	ND	ND	ND	ND	ND
Vanadium	MG/KG	4.6	5.2	7.5	3.5	8.5	4.2	1.0	1.8	3.9	2.6
Zinc	MG/KG	16.5 J	ND	8.0 J	7.3 J	5.0	26.9	ND	3.5	ND	ND

MG/KG - milligrams per kilogram
 J - estimated
 ND - not detected

TABLE 5-4
SURFACE SOIL - POSITIVE DETECTION SUMMARY
SITE 1, FRENCH CREEK LIQUIDS DISPOSAL AREA
REMEDIAL INVESTIGATION CTO - 0231
MCB, CAMP LEJEUNE, NORTH CAROLINA
TOTAL METALS

	Sample ID:	1-GW16DW-00	1-GW16-00	1-GW17DW-00	1-GW17-00
	Sample Depth:	0-1'	0-1'	0-1'	0-1'
	Date Sampled:	5/2/94	4/13/94	5/5/94	4/19/94
	<u>UNITS</u>				
Aluminum	MG/KG	2510	2670	4100	1850
Antimony	MG/KG	ND	ND	ND	ND
Arsenic	MG/KG	0.57	0.73	0.90	1.2
Barium	MG/KG	9.4	9.9	10.6	6.7
Beryllium	MG/KG	ND	ND	ND	ND
Cadmium	MG/KG	0.62	2.0	ND	ND
Calcium	MG/KG	8120	5480	25100 J	40900 J
Chromium	MG/KG	5.9	5.7	5.1	5.9
Copper	MG/KG	3.4	4.9	ND	2.7
Iron	MG/KG	1610	1620	1900	1160
Lead	MG/KG	22.5	23.5	5.2	11.4
Magnesium	MG/KG	197	171	489	556
Manganese	MG/KG	7.4	8.9	9.6	11.4
Mercury	MG/KG	ND	ND	ND	ND
Nickel	MG/KG	2.0	ND	1.6	3.0
Potassium	MG/KG	66.6 J	101 J	151 J	106 J
Selenium	MG/KG	ND	ND	ND	ND
Sodium	MG/KG	40.3	ND	ND	138
Vanadium	MG/KG	4.2	4.6	5.6	2.7
Zinc	MG/KG	12.2	25.2	ND	12.0

MG/KG - milligrams per kilogram
 J - estimated
 ND - not detected

TABLE 5-5
SUBSURFACE SOIL - POSITIVE DETECTION SUMMARY
SITE 1, FRENCH CREEK LIQUIDS DISPOSAL AREA
REMEDIAL INVESTIGATION CTO-0231
MCB, CAMP LEJEUNE, NORTH CAROLINA
TCL ORGANICS

Sample ID:	1-S-SB01-01	1-S-SB01-08	1-S-SB02-04	1-S-SB02-07	1-S-SB03-01	1-S-SB05-01	1-S-SB07-01	1-S-SB07-04
Sample Depth:	1-3'	15-17'	7-9'	13-15'	1-3'	1-3'	1-3'	7-9'
Date Sampled:	3/29/94	3/29/94	4/6/94	4/6/94	3/30/94	3/30/94	3/30/94	3/30/94

UNITS

VOLATILES

	UG/KG	1-S-SB01-01	1-S-SB01-08	1-S-SB02-04	1-S-SB02-07	1-S-SB03-01	1-S-SB05-01	1-S-SB07-01	1-S-SB07-04
Methylene chloride	UG/KG	ND	ND	ND	ND	ND	ND	ND	ND
Acetone	UG/KG	ND	ND	ND	ND	ND	ND	490 J	ND
Trichloroethene	UG/KG	ND	ND	ND	ND	ND	ND	ND	ND
1,1,2,2-Tetrachloroethane	UG/KG	ND	ND	ND	ND	ND	ND	ND	ND
Toluene	UG/KG	ND	ND	ND	ND	ND	ND	ND	ND
Xylenes (total)	UG/KG	ND	ND	ND	ND	ND	ND	ND	ND

SEMIVOLATILES

	UG/KG	1-S-SB01-01	1-S-SB01-08	1-S-SB02-04	1-S-SB02-07	1-S-SB03-01	1-S-SB05-01	1-S-SB07-01	1-S-SB07-04
Phenol	UG/KG	ND	ND	ND	ND	ND	ND	ND	ND
bis(2-Chloroethyl) ether	UG/KG	ND	ND	ND	ND	ND	ND	ND	ND
2-Chlorophenol	UG/KG	ND	ND	ND	ND	ND	ND	ND	ND
1,3-Dichlorobenzene	UG/KG	ND	ND	ND	ND	ND	ND	ND	ND
1,4-Dichlorobenzene	UG/KG	ND	ND	ND	ND	ND	ND	ND	ND
1,2-Dichlorobenzene	UG/KG	ND	ND	ND	ND	ND	ND	ND	ND
2-Methylphenol	UG/KG	ND	ND	ND	ND	ND	ND	ND	ND
2,2'-oxybis-(1-chloropropane)	UG/KG	ND	ND	ND	ND	ND	ND	ND	ND
4-Methylphenol	UG/KG	ND	ND	ND	ND	ND	ND	ND	ND
N-Nitroso-di-n-propylamine	UG/KG	ND	ND	ND	ND	ND	ND	ND	ND
Hexachloroethane	UG/KG	ND	ND	ND	ND	ND	ND	ND	ND
Nitrobenzene	UG/KG	ND	ND	ND	ND	ND	ND	ND	ND
Isophorone	UG/KG	ND	ND	ND	ND	ND	ND	ND	ND
2-Nitrophenol	UG/KG	ND	ND	ND	ND	ND	ND	ND	ND
2,4-Dimethylphenol	UG/KG	ND	ND	ND	ND	ND	ND	ND	ND
bis(2-Chloroethoxy) methane	UG/KG	ND	ND	ND	ND	ND	ND	ND	ND
2,4-Dichlorophenol	UG/KG	ND	ND	ND	ND	ND	ND	ND	ND
1,2,4-Trichlorobenzene	UG/KG	ND	ND	ND	ND	ND	ND	ND	ND
Naphthalene	UG/KG	ND	ND	ND	ND	ND	ND	ND	ND
4-Chloroaniline	UG/KG	ND	ND	ND	ND	ND	ND	ND	ND

UG/KG - micrograms per kilogram

J - estimated

ND - not detected

NJ - tentatively identified

R - rejected

TABLE 5-5
SUBSURFACE SOIL - POSITIVE DETECTION SUMMARY
SITE 1, FRENCH CREEK LIQUIDS DISPOSAL AREA
REMEDIAL INVESTIGATION CTO-0231
MCB, CAMP LEJEUNE, NORTH CAROLINA
TCL ORGANICS

Sample ID:	1-S-SB01-01	1-S-SB01-08	1-S-SB02-04	1-S-SB02-07	1-S-SB03-01	1-S-SB05-01	1-S-SB07-01	1-S-SB07-04
Sample Depth:	1-3'	15-17'	7-9'	13-15'	1-3'	1-3'	1-3'	7-9'
Date Sampled:	3/29/94	3/29/94	4/6/94	4/6/94	3/30/94	3/30/94	3/30/94	3/30/94

UNITS

SEMIVOLATILES Cont.

	UG/KG	ND	ND	ND	ND	ND	ND	ND	ND
Hexachlorobutadiene	UG/KG	ND	ND	ND	ND	ND	ND	ND	ND
4-Chloro-3-methylphenol	UG/KG	ND	ND	ND	ND	ND	ND	ND	ND
2-Methylnaphthalene	UG/KG	ND	ND	ND	ND	ND	ND	ND	ND
Hexachlorocyclopentadiene	UG/KG	ND	ND	ND	ND	ND	ND	ND	ND
2,4,6-Trichlorophenol	UG/KG	ND	ND	ND	ND	ND	ND	ND	ND
2,4,5-Trichlorophenol	UG/KG	ND	ND	ND	ND	ND	ND	ND	ND
2-Chloronaphthalene	UG/KG	ND	ND	ND	ND	ND	ND	ND	ND
2-Nitroaniline	UG/KG	ND	ND	ND	ND	ND	ND	ND	ND
Dimethyl phthalate	UG/KG	ND	ND	ND	ND	ND	ND	ND	ND
Acenaphthylene	UG/KG	ND	ND	ND	ND	ND	ND	ND	ND
2,6-Dinitrotoluene	UG/KG	ND	ND	ND	ND	ND	ND	ND	ND
3-Nitroaniline	UG/KG	ND	ND	ND	ND	ND	ND	ND	ND
Acenaphthene	UG/KG	ND	ND	ND	ND	ND	ND	ND	ND
2,4-Dinitrophenol	UG/KG	ND	ND	ND	ND	ND	ND	ND	ND
4-Nitrophenol	UG/KG	ND	930	ND	ND	ND	ND	ND	ND
Dibenzofuran	UG/KG	ND	ND	ND	ND	ND	ND	ND	ND
2,4-Dinitrotoluene	UG/KG	ND	ND	ND	ND	ND	ND	ND	ND
Diethylphthalate	UG/KG	ND	ND	ND	ND	ND	ND	ND	ND
4-Chlorophenyl phenyl ether	UG/KG	ND	ND	ND	ND	ND	ND	ND	ND
Fluorene	UG/KG	ND	ND	ND	ND	ND	ND	ND	ND
4-Nitroaniline	UG/KG	ND	ND	ND	ND	ND	ND	ND	ND
4,6-Dinitro-2-methylphenol	UG/KG	ND	ND	ND	ND	ND	ND	ND	ND
N-nitrosodiphenylamine	UG/KG	ND	ND	ND	ND	ND	ND	ND	ND
4-Bromophenyl-phenylether	UG/KG	ND	ND	ND	ND	ND	ND	ND	ND
Hexachlorobenzene	UG/KG	ND	ND	ND	ND	ND	ND	ND	ND
Pentachlorophenol	UG/KG	ND	ND	ND	ND	ND	ND	ND	ND
Phenanthrene	UG/KG	ND	ND	ND	ND	ND	ND	ND	ND
Anthracene	UG/KG	ND	ND	ND	ND	ND	ND	ND	ND

UG/KG - micrograms per kilogram

J - estimated

ND - not detected

NJ - tentatively identified

R - rejected

TABLE 5-5
 SUBSURFACE SOIL - POSITIVE DETECTION SUMMARY
 SITE 1, FRENCH CREEK LIQUIDS DISPOSAL AREA
 REMEDIAL INVESTIGATION CTO-0231
 MCB, CAMP LEJEUNE, NORTH CAROLINA
 TCL ORGANICS

Sample ID:	1-S-SB01-01	1-S-SB01-08	1-S-SB02-04	1-S-SB02-07	1-S-SB03-01	1-S-SB05-01	1-S-SB07-01	1-S-SB07-04
Sample Depth:	1-3'	15-17'	7-9'	13-15'	1-3'	1-3'	1-3'	7-9'
Date Sampled:	3/29/94	3/29/94	4/6/94	4/6/94	3/30/94	3/30/94	3/30/94	3/30/94

UNITS

SEMIVOLATILES Cont.

Carbazole	UG/KG	ND	ND	ND	ND	ND	ND	ND	ND
di-n-Butylphthalate	UG/KG	ND	ND	ND	ND	ND	ND	ND	ND
Fluoranthene	UG/KG	ND	ND	ND	ND	ND	ND	ND	ND
Pyrene	UG/KG	ND	ND	ND	ND	ND	ND	ND	ND
Butyl benzyl phthalate	UG/KG	ND	ND	ND	ND	ND	ND	ND	ND
3,3'-Dichlorobenzidine	UG/KG	ND	ND	ND	ND	ND	ND	ND	ND
Benzo[a]anthracene	UG/KG	ND	ND	ND	ND	ND	ND	ND	ND
Chrysene	UG/KG	ND	ND	ND	ND	ND	ND	ND	ND
bis(2-Ethylhexyl)phthalate	UG/KG	2000	1000	800	1800	1400	1200	69 J	460
di-n-Octylphthalate	UG/KG	ND	ND	ND	ND	ND	ND	ND	ND
Benzo[b]fluoranthene	UG/KG	ND	ND	ND	ND	ND	ND	ND	ND
Benzo[k]fluoranthene	UG/KG	ND	ND	ND	ND	ND	ND	ND	ND
Benzo[a]pyrene	UG/KG	ND	ND	ND	ND	ND	ND	ND	ND
Indeno[1,2,3-cd]pyrene	UG/KG	ND	ND	ND	ND	ND	ND	ND	ND
Dibenz[a,h]anthracene	UG/KG	ND	ND	ND	ND	ND	ND	ND	ND
Benzo[g,h,i]perylene	UG/KG	ND	ND	ND	ND	ND	ND	ND	ND

PESTICIDE/PCBs

alpha-BHC	UG/KG	ND	2.0 R	ND	ND	ND	ND	ND	ND
beta-BHC	UG/KG	ND	2.0 R	ND	ND	ND	ND	ND	ND
delta-BHC	UG/KG	ND	2.0 R	ND	ND	ND	ND	ND	ND
Lindane (gamma-BHC)	UG/KG	ND	2.0 R	ND	ND	ND	ND	ND	ND
Heptachlor	UG/KG	ND	2.0 R	ND	ND	ND	ND	ND	ND
Aldrin	UG/KG	ND	2.0 R	ND	ND	ND	ND	ND	ND
Heptachlor epoxide	UG/KG	ND	2.0 R	ND	ND	ND	ND	ND	ND
Endosulfan I	UG/KG	ND	2.0 R	ND	ND	ND	ND	ND	ND
Dieldrin	UG/KG	ND	3.8 R	ND	ND	ND	ND	ND	ND
4,4'-DDE	UG/KG	ND	3.8 R	ND	ND	ND	ND	ND	ND

UG/KG - micrograms per kilogram

J - estimated

ND - not detected

NJ - tentatively identified

R - rejected

TABLE 5-5
SUBSURFACE SOIL - POSITIVE DETECTION SUMMARY
SITE 1, FRENCH CREEK LIQUIDS DISPOSAL AREA
REMEDIAL INVESTIGATION CTO-0231
MCB, CAMP LEJEUNE, NORTH CAROLINA
TCL ORGANICS

Sample ID:	1-S-SB01-01	1-S-SB01-08	1-S-SB02-04	1-S-SB02-07	1-S-SB03-01	1-S-SB05-01	1-S-SB07-01	1-S-SB07-04
Sample Depth:	1-3'	15-17'	7-9'	13-15'	1-3'	1-3'	1-3'	7-9'
Date Sampled:	3/29/94	3/29/94	4/6/94	4/6/94	3/30/94	3/30/94	3/30/94	3/30/94

UNITS

PESTICIDE/PCBs Cont.

	UG/KG	ND	3.8 R	ND	ND	ND	ND	ND	ND
Endrin	UG/KG	ND	3.8 R	ND	ND	ND	ND	ND	ND
Endosulfan II	UG/KG	ND	3.8 R	ND	ND	ND	ND	ND	ND
4,4'-DDD	UG/KG	ND	3.8 R	ND	ND	ND	ND	ND	ND
Endosulfan sulfate	UG/KG	ND	3.8 R	ND	ND	ND	ND	ND	ND
4,4'-DDT	UG/KG	ND	3.8 R	ND	ND	ND	ND	ND	ND
Methoxychlor	UG/KG	ND	20 R	ND	ND	ND	ND	ND	ND
Endrin ketone	UG/KG	ND	3.8 R	ND	ND	ND	ND	ND	ND
Endrin aldehyde	UG/KG	ND	3.8 R	ND	ND	ND	ND	ND	ND
alpha-Chlordane	UG/KG	ND	2.0 R	ND	ND	ND	ND	ND	ND
gamma-Chlordane	UG/KG	ND	2.0 R	ND	ND	ND	ND	ND	ND
Toxaphene	UG/KG	ND	200 R	ND	ND	ND	ND	ND	ND
Aroclor 1016	UG/KG	ND	38 R	ND	ND	ND	ND	ND	ND
Aroclor 1221	UG/KG	ND	78 R	ND	ND	ND	ND	ND	ND
Aroclor 1232	UG/KG	ND	38 R	ND	ND	ND	ND	ND	ND
Aroclor 1242	UG/KG	ND	38 R	ND	ND	ND	ND	ND	ND
Aroclor 1248	UG/KG	ND	38 R	ND	ND	ND	ND	ND	ND
Aroclor 1254	UG/KG	ND	38 R	ND	ND	ND	ND	ND	ND
Aroclor 1260	UG/KG	ND	38 R	ND	ND	ND	ND	ND	ND

UG/KG - micrograms per kilogram

J - estimated

ND - not detected

NJ - tentatively identified

R - rejected

TABLE 5-5
SUBSURFACE SOIL - POSITIVE DETECTION SUMMARY
SITE 1, FRENCH CREEK LIQUIDS DISPOSAL AREA
REMEDIAL INVESTIGATION CTO-0231
MCB, CAMP LEJEUNE, NORTH CAROLINA
TCL ORGANICS

Sample ID:	1-S-SB08-01	1-S-SB08-04	1-S-SB08-07	1-S-SB09-01	1-S-SB09-04	1-S-SB09-07	1-S-SB10-01	1-S-SB11-01
Sample Depth:	1-3'	7-9'	13-15'	1-3'	7-9'	13-15'	1-3'	1-3'
Date Sampled:	4/5/94	4/5/94	4/5/94	4/5/94	4/5/94	4/5/94	3/29/94	3/30/94

UNITS

VOLATILES

Methylene chloride	UG/KG	ND	ND	ND	ND	ND	ND	ND
Acetone	UG/KG	30	ND	ND	57	ND	ND	ND
Trichloroethene	UG/KG	ND	ND	ND	ND	ND	ND	ND
1,1,2,2-Tetrachloroethane	UG/KG	ND	ND	ND	ND	ND	ND	ND
Toluene	UG/KG	ND	ND	ND	ND	ND	ND	ND
Xylenes (total)	UG/KG	ND	ND	ND	ND	ND	ND	ND

SEMIVOLATILES

Phenol	UG/KG	ND	ND	ND	ND	ND	ND	ND
bis(2-Chloroethyl) ether	UG/KG	ND	ND	ND	ND	ND	ND	ND
2-Chlorophenol	UG/KG	ND	ND	ND	ND	ND	ND	ND
1,3-Dichlorobenzene	UG/KG	ND	ND	ND	ND	ND	ND	ND
1,4-Dichlorobenzene	UG/KG	ND	ND	ND	ND	ND	ND	ND
1,2-Dichlorobenzene	UG/KG	ND	ND	ND	ND	ND	ND	ND
2-Methylphenol	UG/KG	ND	ND	ND	ND	ND	ND	ND
2,2'-oxybis-(1-chloropropane)	UG/KG	ND	ND	ND	ND	ND	ND	ND
4-Methylphenol	UG/KG	ND	ND	ND	ND	ND	ND	ND
N-Nitroso-di-n-propylamine	UG/KG	ND	ND	ND	ND	ND	ND	ND
Hexachloroethane	UG/KG	ND	ND	ND	ND	ND	ND	ND
Nitrobenzene	UG/KG	ND	ND	ND	ND	ND	ND	ND
Isophorone	UG/KG	ND	ND	ND	ND	ND	ND	ND
2-Nitrophenol	UG/KG	ND	ND	ND	ND	ND	ND	ND
2,4-Dimethylphenol	UG/KG	ND	ND	ND	ND	ND	ND	ND
bis(2-Chloroethoxy) methane	UG/KG	ND	ND	ND	ND	ND	ND	ND
2,4-Dichlorophenol	UG/KG	ND	ND	ND	ND	ND	ND	ND
1,2,4-Trichlorobenzene	UG/KG	ND	ND	ND	ND	ND	ND	ND
Naphthalene	UG/KG	ND	ND	ND	ND	ND	ND	ND
4-Chloroaniline	UG/KG	ND	ND	ND	ND	ND	ND	ND

UG/KG - micrograms per kilogram

J - estimated

ND - not detected

NJ - tentatively identified

R - rejected

TABLE 5-5
SUBSURFACE SOIL - POSITIVE DETECTION SUMMARY
SITE 1, FRENCH CREEK LIQUIDS DISPOSAL AREA
REMEDIAL INVESTIGATION CTO-0231
MCB, CAMP LEJEUNE, NORTH CAROLINA
TCL ORGANICS

Sample ID:	1-S-SB08-01	1-S-SB08-04	1-S-SB08-07	1-S-SB09-01	1-S-SB09-04	1-S-SB09-07	1-S-SB10-01	1-S-SB11-01
Sample Depth:	1-3'	7-9'	13-15'	1-3'	7-9'	13-15'	1-3'	1-3'
Date Sampled:	4/5/94	4/5/94	4/5/94	4/5/94	4/5/94	4/5/94	3/29/94	3/30/94

UNITS

SEMIVOLATILES Cont.

Hexachlorobutadiene	UG/KG	ND	ND	ND	ND	ND	ND	ND
4-Chloro-3-methylphenol	UG/KG	ND	ND	ND	ND	ND	ND	ND
2-Methylnaphthalene	UG/KG	ND	ND	ND	ND	ND	ND	ND
Hexachlorocyclopentadiene	UG/KG	ND	ND	ND	ND	ND	ND	ND
2,4,6-Trichlorophenol	UG/KG	ND	ND	ND	ND	ND	ND	ND
2,4,5-Trichlorophenol	UG/KG	ND	ND	ND	ND	ND	ND	ND
2-Chloronaphthalene	UG/KG	ND	ND	ND	ND	ND	ND	ND
2-Nitroaniline	UG/KG	ND	ND	ND	ND	ND	ND	ND
Dimethyl phthalate	UG/KG	ND	ND	ND	ND	ND	ND	ND
Acenaphthylene	UG/KG	ND	ND	ND	ND	ND	ND	ND
2,6-Dinitrotoluene	UG/KG	ND	ND	ND	ND	ND	ND	ND
3-Nitroaniline	UG/KG	ND	ND	ND	ND	ND	ND	ND
Acenaphthene	UG/KG	ND	ND	ND	ND	ND	ND	ND
2,4-Dinitrophenol	UG/KG	ND	ND	ND	ND	ND	ND	ND
4-Nitrophenol	UG/KG	ND	ND	ND	ND	ND	ND	ND
Dibenzofuran	UG/KG	ND	ND	ND	ND	ND	ND	ND
2,4-Dinitrotoluene	UG/KG	ND	ND	ND	ND	ND	ND	ND
Diethylphthalate	UG/KG	ND	ND	ND	ND	ND	ND	ND
4-Chlorophenyl phenyl ether	UG/KG	ND	ND	ND	ND	ND	ND	ND
Fluorene	UG/KG	ND	ND	ND	ND	ND	ND	ND
4-Nitroaniline	UG/KG	ND	ND	ND	ND	ND	ND	ND
4,6-Dinitro-2-methylphenol	UG/KG	ND	ND	ND	ND	ND	ND	ND
N-nitrosodiphenylamine	UG/KG	ND	ND	ND	ND	ND	ND	ND
4-Bromophenyl-phenylether	UG/KG	ND	ND	ND	ND	ND	ND	ND
Hexachlorobenzene	UG/KG	ND	ND	ND	ND	ND	ND	ND
Pentachlorophenol	UG/KG	ND	ND	ND	ND	ND	ND	ND
Phenanthrene	UG/KG	ND	ND	ND	ND	ND	ND	ND
Anthracene	UG/KG	ND	ND	ND	ND	ND	ND	ND

UG/KG - micrograms per kilogram

J - estimated

ND - not detected

NJ - tentatively identified

R - rejected

TABLE 5-5
SUBSURFACE SOIL - POSITIVE DETECTION SUMMARY
SITE 1, FRENCH CREEK LIQUIDS DISPOSAL AREA
REMEDIAL INVESTIGATION CTO-0231
MCB, CAMP LEJEUNE, NORTH CAROLINA
TCL ORGANICS

Sample ID:	1-S-SB08-01	1-S-SB08-04	1-S-SB08-07	1-S-SB09-01	1-S-SB09-04	1-S-SB09-07	1-S-SB10-01	1-S-SB11-01
Sample Depth:	1-3'	7-9'	13-15'	1-3'	7-9'	13-15'	1-3'	1-3'
Date Sampled:	4/5/94	4/5/94	4/5/94	4/5/94	4/5/94	4/5/94	3/29/94	3/30/94

UNITS

SEMIVOLATILES Cont.

Carbazole	UG/KG	ND	ND	ND	ND	ND	ND	ND	ND
di-n-Butylphthalate	UG/KG	ND	ND	ND	ND	ND	ND	ND	ND
Fluoranthene	UG/KG	ND	ND	ND	ND	ND	ND	ND	ND
Pyrene	UG/KG	ND	ND	ND	ND	ND	ND	ND	ND
Butyl benzyl phthalate	UG/KG	ND	ND	ND	ND	ND	ND	ND	ND
3,3'-Dichlorobenzidine	UG/KG	ND	ND	ND	ND	ND	ND	ND	ND
Benzo[a]anthracene	UG/KG	ND	ND	ND	ND	ND	ND	ND	ND
Chrysene	UG/KG	ND	ND	ND	ND	ND	ND	ND	ND
bis(2-Ethylhexyl)phthalate	UG/KG	710	390	92 J	160 J	530	2000	2100	44 J
di-n-Octylphthalate	UG/KG	ND	ND	ND	ND	ND	ND	ND	ND
Benzo[b]fluoranthene	UG/KG	ND	ND	ND	ND	ND	ND	ND	ND
Benzo[k]fluoranthene	UG/KG	ND	ND	ND	ND	ND	ND	ND	ND
Benzo[a]pyrene	UG/KG	ND	ND	ND	ND	ND	ND	ND	ND
Indeno[1,2,3-cd]pyrene	UG/KG	ND	ND	ND	ND	ND	ND	ND	ND
Dibenz[a,h]anthracene	UG/KG	ND	ND	ND	ND	ND	ND	ND	ND
Benzo[g,h,i]perylene	UG/KG	ND	ND	ND	ND	ND	ND	ND	ND

PESTICIDE/PCBs

alpha-BHC	UG/KG	ND	ND	ND	ND	ND	ND	ND	ND
beta-BHC	UG/KG	ND	ND	ND	ND	ND	ND	ND	ND
delta-BHC	UG/KG	ND	ND	ND	ND	ND	ND	ND	ND
Lindane (gamma-BHC)	UG/KG	ND	ND	ND	ND	ND	ND	ND	ND
Heptachlor	UG/KG	ND	ND	ND	ND	ND	ND	ND	ND
Aldrin	UG/KG	ND	ND	ND	ND	ND	ND	ND	ND
Heptachlor epoxide	UG/KG	ND	ND	ND	ND	ND	ND	ND	ND
Endosulfan I	UG/KG	ND	ND	ND	ND	ND	ND	ND	ND
Dieldrin	UG/KG	ND	ND	ND	ND	ND	ND	ND	ND
4,4'-DDE	UG/KG	ND	ND	ND	ND	ND	ND	ND	ND

UG/KG - micrograms per kilogram

J - estimated

ND - not detected

NJ - tentatively identified

R - rejected

TABLE 5-5
SUBSURFACE SOIL - POSITIVE DETECTION SUMMARY
SITE 1, FRENCH CREEK LIQUIDS DISPOSAL AREA
REMEDIAL INVESTIGATION CTO-0231
MCB, CAMP LEJEUNE, NORTH CAROLINA
TCL ORGANICS

Sample ID:	1-S-SB08-01	1-S-SB08-04	1-S-SB08-07	1-S-SB09-01	1-S-SB09-04	1-S-SB09-07	1-S-SB10-01	1-S-SB11-01
Sample Depth:	1-3'	7-9'	13-15'	1-3'	7-9'	13-15'	1-3'	1-3'
Date Sampled:	4/5/94	4/5/94	4/5/94	4/5/94	4/5/94	4/5/94	3/29/94	3/30/94

UNITS

PESTICIDE/PCBs Cont.

	UG/KG	ND	ND	ND	ND	ND	ND	ND	ND
Endrin	UG/KG	ND	ND	ND	ND	ND	ND	ND	ND
Endosulfan II	UG/KG	ND	ND	ND	ND	ND	ND	ND	ND
4,4'-DDD	UG/KG	ND	ND	ND	ND	ND	ND	ND	ND
Endosulfan sulfate	UG/KG	ND	ND	ND	ND	ND	ND	ND	ND
4,4'-DDT	UG/KG	1.6 J	ND	ND	ND	ND	ND	ND	ND
Methoxychlor	UG/KG	ND	ND	ND	ND	ND	ND	ND	ND
Endrin ketone	UG/KG	ND	ND	ND	ND	ND	ND	ND	ND
Endrin aldehyde	UG/KG	ND	ND	ND	ND	ND	ND	ND	ND
alpha-Chlordane	UG/KG	ND	ND	ND	ND	ND	ND	ND	ND
gamma-Chlordane	UG/KG	ND	ND	ND	ND	ND	ND	ND	ND
Toxaphene	UG/KG	ND	ND	ND	ND	ND	ND	ND	ND
Aroclor 1016	UG/KG	ND	ND	ND	ND	ND	ND	ND	ND
Aroclor 1221	UG/KG	ND	ND	ND	ND	ND	ND	ND	ND
Aroclor 1232	UG/KG	ND	ND	ND	ND	ND	ND	ND	ND
Aroclor 1242	UG/KG	ND	ND	ND	ND	ND	ND	ND	ND
Aroclor 1248	UG/KG	ND	ND	ND	ND	ND	ND	ND	ND
Aroclor 1254	UG/KG	ND	ND	ND	ND	ND	ND	ND	ND
Aroclor 1260	UG/KG	ND	ND	ND	ND	ND	ND	ND	ND

UG/KG - micrograms per kilogram

J - estimated

ND - not detected

NJ - tentatively identified

R - rejected

TABLE 5-5
SUBSURFACE SOIL - POSITIVE DETECTION SUMMARY
SITE 1, FRENCH CREEK LIQUIDS DISPOSAL AREA
REMEDIAL INVESTIGATION CTO-0231
MCB, CAMP LEJEUNE, NORTH CAROLINA
TCL ORGANICS

Sample ID:	1-S-SB11-06	1-S-SB12-01	1-S-SB13-01	1-S-SB13-04	1-S-SB13-07	1-S-SB14-01	1-S-SB15-06	1-S-SB16-01	1-S-SB17-01
Sample Depth:	11-13'	1-3'	1-3'	7-9'	13-15'	1-3'	11-13'	1-3'	1-3'
Date Sampled:	3/30/94	4/6/94	4/6/94	4/6/94	4/6/94	4/6/94	4/5/94	4/5/94	3/30/94

UNITS

VOLATILES

	UG/KG	1-S-SB11-06	1-S-SB12-01	1-S-SB13-01	1-S-SB13-04	1-S-SB13-07	1-S-SB14-01	1-S-SB15-06	1-S-SB16-01	1-S-SB17-01
Methylene chloride	UG/KG	ND	ND	ND	ND	ND	ND	ND	ND	ND
Acetone	UG/KG	ND	ND	ND	ND	ND	ND	11	ND	ND
Trichloroethene	UG/KG	ND	ND	ND	ND	ND	ND	ND	ND	ND
1,1,2,2-Tetrachloroethane	UG/KG	27	ND	ND	ND	ND	ND	ND	ND	ND
Toluene	UG/KG	ND	ND	ND	ND	ND	ND	ND	ND	ND
Xylenes (total)	UG/KG	ND	ND	ND	ND	ND	ND	ND	ND	ND

SEMIVOLATILES

	UG/KG	1-S-SB11-06	1-S-SB12-01	1-S-SB13-01	1-S-SB13-04	1-S-SB13-07	1-S-SB14-01	1-S-SB15-06	1-S-SB16-01	1-S-SB17-01
Phenol	UG/KG	ND	ND	ND	ND	ND	ND	350 R	ND	ND
bis(2-Chloroethyl) ether	UG/KG	ND	ND	ND	ND	ND	ND	350 R	ND	ND
2-Chlorophenol	UG/KG	ND	ND	ND	ND	ND	ND	350 R	ND	ND
1,3-Dichlorobenzene	UG/KG	ND	ND	ND	ND	ND	ND	350 R	ND	ND
1,4-Dichlorobenzene	UG/KG	ND	ND	ND	ND	ND	ND	350 R	ND	ND
1,2-Dichlorobenzene	UG/KG	ND	ND	ND	ND	ND	ND	350 R	ND	ND
2-Methylphenol	UG/KG	ND	ND	ND	ND	ND	ND	350 R	ND	ND
2,2'-oxybis-(1-chloropropane)	UG/KG	ND	ND	ND	ND	ND	ND	350 R	ND	ND
4-Methylphenol	UG/KG	ND	ND	ND	ND	ND	ND	350 R	ND	ND
N-Nitroso-di-n-propylamine	UG/KG	ND	ND	ND	ND	ND	ND	350 R	ND	ND
Hexachloroethane	UG/KG	ND	ND	ND	ND	ND	ND	350 R	ND	ND
Nitrobenzene	UG/KG	ND	ND	ND	ND	ND	ND	350 R	ND	ND
Isophorone	UG/KG	ND	ND	ND	ND	ND	ND	350 R	ND	ND
2-Nitrophenol	UG/KG	ND	ND	ND	ND	ND	ND	350 R	ND	ND
2,4-Dimethylphenol	UG/KG	ND	ND	ND	ND	ND	ND	350 R	ND	ND
bis(2-Chloroethoxy) methane	UG/KG	ND	ND	ND	ND	ND	ND	350 R	ND	ND
2,4-Dichlorophenol	UG/KG	ND	ND	ND	ND	ND	ND	350 R	ND	ND
1,2,4-Trichlorobenzene	UG/KG	ND	ND	ND	ND	ND	ND	350 R	ND	ND
Naphthalene	UG/KG	ND	ND	ND	ND	ND	ND	350 R	ND	ND
4-Chloroaniline	UG/KG	ND	ND	ND	ND	ND	ND	350 R	ND	ND

UG/KG - micrograms per kilogram

J - estimated

ND - not detected

NJ - tentatively identified

R - rejected

TABLE 5-5
 SUBSURFACE SOIL - POSITIVE DETECTION SUMMARY
 SITE 1, FRENCH CREEK LIQUIDS DISPOSAL AREA
 REMEDIAL INVESTIGATION CTO-0231
 MCB, CAMP LEJEUNE, NORTH CAROLINA
 TCL ORGANICS

Sample ID:	1-S-SB11-06	1-S-SB12-01	1-S-SB13-01	1-S-SB13-04	1-S-SB13-07	1-S-SB14-01	1-S-SB15-06	1-S-SB16-01	1-S-SB17-01
Sample Depth:	11-13'	1-3'	1-3'	7-9'	13-15'	1-3'	11-13'	1-3'	1-3'
Date Sampled:	3/30/94	4/6/94	4/6/94	4/6/94	4/6/94	4/6/94	4/5/94	4/5/94	3/30/94

UNITS

SEMIVOLATILES Cont.

Hexachlorobutadiene	UG/KG	ND	ND	ND	ND	ND	ND	350 R	ND	ND
4-Chloro-3-methylphenol	UG/KG	ND	ND	ND	ND	ND	ND	350 R	ND	ND
2-Methylnaphthalene	UG/KG	ND	ND	ND	ND	ND	ND	350 R	ND	ND
Hexachlorocyclopentadiene	UG/KG	ND	ND	ND	ND	ND	ND	350 R	ND	ND
2,4,6-Trichlorophenol	UG/KG	ND	ND	ND	ND	ND	ND	350 R	ND	ND
2,4,5-Trichlorophenol	UG/KG	ND	ND	ND	ND	ND	ND	840 R	ND	ND
2-Chloronaphthalene	UG/KG	ND	ND	ND	ND	ND	ND	350 R	ND	ND
2-Nitroaniline	UG/KG	ND	ND	ND	ND	ND	ND	840 R	ND	ND
Dimethyl phthalate	UG/KG	ND	ND	ND	ND	ND	ND	350 R	ND	ND
Acenaphthylene	UG/KG	ND	ND	ND	ND	ND	ND	350 R	ND	ND
2,6-Dinitrotoluene	UG/KG	ND	ND	ND	ND	ND	ND	350 R	ND	ND
3-Nitroaniline	UG/KG	ND	ND	ND	ND	ND	ND	840 R	ND	ND
Acenaphthene	UG/KG	ND	ND	ND	ND	ND	ND	350 R	ND	ND
2,4-Dinitrophenol	UG/KG	ND	ND	ND	ND	ND	ND	840 R	ND	ND
4-Nitrophenol	UG/KG	ND	ND	ND	ND	ND	ND	840 R	ND	ND
Dibenzofuran	UG/KG	ND	ND	ND	ND	ND	ND	350 R	ND	ND
2,4-Dinitrotoluene	UG/KG	ND	ND	ND	ND	ND	ND	350 R	ND	ND
Diethylphthalate	UG/KG	ND	ND	ND	ND	ND	ND	350 R	ND	ND
4-Chlorophenyl phenyl ether	UG/KG	ND	ND	ND	ND	ND	ND	350 R	ND	ND
Fluorene	UG/KG	ND	ND	ND	ND	ND	ND	350 R	ND	ND
4-Nitroaniline	UG/KG	ND	ND	ND	ND	ND	ND	840 R	ND	ND
4,6-Dinitro-2-methylphenol	UG/KG	ND	ND	ND	ND	ND	ND	840 R	ND	ND
N-nitrosodiphenylamine	UG/KG	ND	ND	ND	ND	ND	ND	350 R	ND	ND
4-Bromophenyl-phenylether	UG/KG	ND	ND	ND	ND	ND	ND	350 R	ND	ND
Hexachlorobenzene	UG/KG	ND	ND	ND	ND	ND	ND	350 R	ND	ND
Pentachlorophenol	UG/KG	ND	ND	ND	ND	ND	ND	840 R	ND	ND
Phenanthrene	UG/KG	ND	ND	ND	ND	ND	ND	350 R	ND	ND
Anthracene	UG/KG	ND	ND	ND	ND	ND	ND	350 R	ND	ND

UG/KG - micrograms per kilogram

J - estimated

ND - not detected

NJ - tentatively identified

R - rejected

TABLE 5-5
SUBSURFACE SOIL - POSITIVE DETECTION SUMMARY
SITE 1, FRENCH CREEK LIQUIDS DISPOSAL AREA
REMEDIAL INVESTIGATION CTO-0231
MCB, CAMP LEJEUNE, NORTH CAROLINA
TCL ORGANICS

Sample ID:	1-S-SB11-06	1-S-SB12-01	1-S-SB13-01	1-S-SB13-04	1-S-SB13-07	1-S-SB14-01	1-S-SB15-06	1-S-SB16-01	1-S-SB17-01
Sample Depth:	11-13'	1-3'	1-3'	7-9'	13-15'	1-3'	11-13'	1-3'	1-3'
Date Sampled:	3/30/94	4/6/94	4/6/94	4/6/94	4/6/94	4/6/94	4/5/94	4/5/94	3/30/94

UNITS

SEMIVOLATILES Cont.

Carbazole	UG/KG	ND	ND	ND	ND	ND	ND	350 R	ND	ND
di-n-Butylphthalate	UG/KG	ND	ND	ND	ND	ND	ND	350 R	ND	ND
Fluoranthene	UG/KG	ND	ND	ND	ND	ND	ND	350 R	ND	ND
Pyrene	UG/KG	ND	ND	ND	ND	ND	ND	350 R	ND	ND
Butyl benzyl phthalate	UG/KG	ND	ND	ND	ND	ND	ND	350 R	ND	ND
3,3'-Dichlorobenzidine	UG/KG	ND	ND	ND	ND	ND	ND	350 R	ND	ND
Benzo[a]anthracene	UG/KG	ND	ND	ND	ND	ND	ND	350 R	ND	ND
Chrysene	UG/KG	ND	ND	ND	ND	ND	ND	350 R	ND	ND
bis(2-Ethylhexyl)phthalate	UG/KG	ND	66 J	360 J	120 J	100 J	49 J	350 R	580	350
di-n-Octylphthalate	UG/KG	390 R	ND	ND	ND	ND	ND	350 R	ND	ND
Benzo[b]fluoranthene	UG/KG	ND	ND	ND	ND	ND	ND	350 R	ND	ND
Benzo[k]fluoranthene	UG/KG	ND	ND	ND	ND	ND	ND	350 R	ND	ND
Benzo[a]pyrene	UG/KG	ND	ND	ND	ND	ND	ND	350 R	ND	ND
Indeno[1,2,3-cd]pyrene	UG/KG	ND	ND	ND	ND	ND	ND	350 R	ND	ND
Dibenz[a,h]anthracene	UG/KG	ND	ND	ND	ND	ND	ND	350 R	ND	ND
Benzo[g,h,i]perylene	UG/KG	ND	ND	ND	ND	ND	ND	350 R	ND	ND

PESTICIDE/PCBs

alpha-BHC	UG/KG	ND	ND	ND	ND	ND	ND	ND	ND	ND
beta-BHC	UG/KG	ND	ND	ND	ND	ND	ND	ND	ND	ND
delta-BHC	UG/KG	ND	ND	ND	ND	ND	ND	ND	ND	ND
Lindane (gamma-BHC)	UG/KG	ND	ND	ND	ND	ND	ND	ND	ND	ND
Heptachlor	UG/KG	ND	ND	ND	ND	ND	ND	ND	ND	ND
Aldrin	UG/KG	ND	ND	ND	ND	ND	ND	ND	ND	ND
Heptachlor epoxide	UG/KG	ND	ND	ND	ND	ND	ND	ND	ND	ND
Endosulfan I	UG/KG	ND	ND	ND	ND	ND	ND	ND	ND	ND
Dieldrin	UG/KG	ND	ND	ND	ND	ND	ND	ND	ND	ND
4,4'-DDE	UG/KG	ND	ND	ND	ND	ND	ND	ND	ND	ND

UG/KG - micrograms per kilogram

J - estimated

ND - not detected

NJ - tentatively identified

R - rejected

TABLE 5-5
SUBSURFACE SOIL - POSITIVE DETECTION SUMMARY
SITE 1, FRENCH CREEK LIQUIDS DISPOSAL AREA
REMEDIAL INVESTIGATION CTO-0231
MCB, CAMP LEJEUNE, NORTH CAROLINA
TCL ORGANICS

Sample ID:	1-S-SB11-06	1-S-SB12-01	1-S-SB13-01	1-S-SB13-04	1-S-SB13-07	1-S-SB14-01	1-S-SB15-06	1-S-SB16-01	1-S-SB17-01
Sample Depth:	11-13'	1-3'	1-3'	7-9'	13-15'	1-3'	11-13'	1-3'	1-3'
Date Sampled:	3/30/94	4/6/94	4/6/94	4/6/94	4/6/94	4/6/94	4/5/94	4/5/94	3/30/94

UNITS

PESTICIDE/PCBs Cont.

Endrin	UG/KG	ND	ND	ND	ND	ND	ND	ND	ND	ND
Endosulfan II	UG/KG	ND	ND	ND	ND	ND	ND	ND	ND	ND
4,4'-DDD	UG/KG	ND	ND	ND	ND	ND	ND	ND	ND	ND
Endosulfan sulfate	UG/KG	ND	ND	ND	ND	ND	ND	ND	ND	ND
4,4'-DDT	UG/KG	ND	ND	ND	ND	ND	ND	ND	ND	ND
Methoxychlor	UG/KG	ND	ND	ND	ND	ND	ND	ND	ND	ND
Endrin ketone	UG/KG	ND	ND	ND	ND	ND	ND	ND	ND	ND
Endrin aldehyde	UG/KG	ND	ND	ND	ND	ND	ND	ND	ND	ND
alpha-Chlordane	UG/KG	ND	ND	ND	ND	ND	ND	ND	ND	ND
gamma-Chlordane	UG/KG	ND	ND	ND	ND	ND	ND	ND	ND	ND
Toxaphene	UG/KG	ND	ND	ND	ND	ND	ND	ND	ND	ND
Aroclor 1016	UG/KG	ND	ND	ND	ND	ND	ND	ND	ND	ND
Aroclor 1221	UG/KG	ND	ND	ND	ND	ND	ND	ND	ND	ND
Aroclor 1232	UG/KG	ND	ND	ND	ND	ND	ND	ND	ND	ND
Aroclor 1242	UG/KG	ND	ND	ND	ND	ND	ND	ND	ND	ND
Aroclor 1248	UG/KG	ND	ND	ND	ND	ND	ND	ND	ND	ND
Aroclor 1254	UG/KG	ND	ND	ND	ND	ND	ND	ND	ND	ND
Aroclor 1260	UG/KG	ND	ND	ND	ND	ND	ND	ND	ND	ND

UG/KG - micrograms per kilogram

J - estimated

ND - not detected

NJ - tentatively identified

R - rejected

TABLE 5-5
SUBSURFACE SOIL - POSITIVE DETECTION SUMMARY
SITE 1, FRENCH CREEK LIQUIDS DISPOSAL AREA
REMEDIAL INVESTIGATION CTO-0231
MCB, CAMP LEJEUNE, NORTH CAROLINA
TCL ORGANICS

Sample ID:	1-S-SB17-03	1-S-SB18-07	1-N-SB20-05	1-N-SB21-07	1-N-SB22-01	1-N-SB22-06	1-N-SB22-08	1-N-SB24-04	1-N-SB24-07
Sample Depth:	5-7'	13-15'	9-11'	13-15'	1-3'	11-13'	15-17'	7-9'	13-15'
Date Sampled:	3/30/94	4/5/94	3/29/94	3/29/94	4/5/94	4/5/94	4/5/94	3/29/94	3/29/94

UNITS

VOLATILES

Methylene chloride	UG/KG	ND	3 J	ND	ND	ND	ND	ND	ND	ND
Acetone	UG/KG	ND	9 J	ND	ND	ND	9 J	330	ND	ND
Trichloroethene	UG/KG	ND	ND	ND	ND	ND	ND	ND	ND	ND
1,1,2,2-Tetrachloroethane	UG/KG	ND	ND	ND	ND	ND	ND	ND	ND	ND
Toluene	UG/KG	ND	ND	ND	ND	ND	ND	ND	ND	ND
Xylenes (total)	UG/KG	ND	ND	ND	ND	ND	ND	ND	ND	ND

SEMIVOLATILES

Phenol	UG/KG	ND	ND	ND	ND	ND	ND	ND	ND	ND
bis(2-Chloroethyl) ether	UG/KG	ND	ND	ND	ND	ND	ND	ND	ND	ND
2-Chlorophenol	UG/KG	ND	ND	ND	ND	ND	ND	ND	ND	ND
1,3-Dichlorobenzene	UG/KG	ND	ND	ND	ND	ND	ND	ND	ND	ND
1,4-Dichlorobenzene	UG/KG	ND	ND	ND	ND	ND	ND	ND	ND	ND
1,2-Dichlorobenzene	UG/KG	ND	ND	ND	ND	ND	ND	ND	ND	ND
2-Methylphenol	UG/KG	ND	ND	ND	ND	ND	ND	ND	ND	ND
2,2'-oxybis-(1-chloropropane)	UG/KG	ND	ND	ND	ND	ND	ND	ND	ND	ND
4-Methylphenol	UG/KG	ND	ND	ND	ND	ND	ND	ND	ND	ND
N-Nitroso-di-n-propylamine	UG/KG	ND	ND	ND	ND	ND	ND	ND	ND	ND
Hexachloroethane	UG/KG	ND	ND	ND	ND	ND	ND	ND	ND	ND
Nitrobenzene	UG/KG	ND	ND	ND	ND	ND	ND	ND	ND	ND
Isophorone	UG/KG	ND	ND	ND	ND	ND	ND	ND	ND	ND
2-Nitrophenol	UG/KG	ND	ND	ND	ND	ND	ND	ND	ND	ND
2,4-Dimethylphenol	UG/KG	ND	ND	ND	ND	ND	ND	ND	ND	ND
bis(2-Chloroethoxy) methane	UG/KG	ND	ND	ND	ND	ND	ND	ND	ND	ND
2,4-Dichlorophenol	UG/KG	ND	ND	ND	ND	ND	ND	ND	ND	ND
1,2,4-Trichlorobenzene	UG/KG	ND	ND	ND	ND	ND	ND	ND	ND	ND
Naphthalene	UG/KG	ND	ND	ND	ND	ND	ND	ND	ND	ND
4-Chloroaniline	UG/KG	ND	ND	ND	ND	ND	ND	ND	ND	ND

UG/KG - micrograms per kilogram

J - estimated

ND - not detected

NJ - tentatively identified

R - rejected

TABLE 5-5
SUBSURFACE SOIL - POSITIVE DETECTION SUMMARY
SITE 1, FRENCH CREEK LIQUIDS DISPOSAL AREA
REMEDIAL INVESTIGATION CTO-0231
MCB, CAMP LEJEUNE, NORTH CAROLINA
TCL ORGANICS

Sample ID:	1-S-SB17-03	1-S-SB18-07	1-N-SB20-05	1-N-SB21-07	1-N-SB22-01	1-N-SB22-06	1-N-SB22-08	1-N-SB24-04	1-N-SB24-07
Sample Depth:	5-7'	13-15'	9-11'	13-15'	1-3'	11-13'	15-17'	7-9'	13-15'
Date Sampled:	3/30/94	4/5/94	3/29/94	3/29/94	4/5/94	4/5/94	4/5/94	3/29/94	3/29/94

UNITS

SEMIVOLATILES Cont.

Hexachlorobutadiene	UG/KG	ND	ND	ND	ND	ND	ND	ND	ND	ND
4-Chloro-3-methylphenol	UG/KG	ND	ND	ND	ND	ND	ND	ND	ND	ND
2-Methylnaphthalene	UG/KG	ND	ND	ND	ND	ND	ND	ND	ND	ND
Hexachlorocyclopentadiene	UG/KG	ND	ND	ND	ND	ND	ND	ND	ND	ND
2,4,6-Trichlorophenol	UG/KG	ND	ND	ND	ND	ND	ND	ND	ND	ND
2,4,5-Trichlorophenol	UG/KG	ND	ND	ND	ND	ND	ND	ND	ND	ND
2-Chloronaphthalene	UG/KG	ND	ND	ND	ND	ND	ND	ND	ND	ND
2-Nitroaniline	UG/KG	ND	ND	ND	ND	ND	ND	ND	ND	ND
Dimethyl phthalate	UG/KG	ND	ND	ND	ND	ND	ND	ND	ND	ND
Acenaphthylene	UG/KG	ND	ND	ND	ND	ND	ND	ND	ND	ND
2,6-Dinitrotoluene	UG/KG	ND	ND	ND	ND	ND	ND	ND	ND	ND
3-Nitroaniline	UG/KG	ND	ND	ND	ND	ND	ND	ND	ND	ND
Acenaphthene	UG/KG	ND	ND	ND	ND	ND	ND	ND	ND	ND
2,4-Dinitrophenol	UG/KG	ND	ND	ND	ND	ND	ND	ND	ND	ND
4-Nitrophenol	UG/KG	ND	ND	ND	ND	ND	ND	ND	ND	ND
Dibenzofuran	UG/KG	ND	ND	ND	ND	ND	ND	ND	ND	ND
2,4-Dinitrotoluene	UG/KG	ND	ND	ND	ND	ND	ND	ND	ND	ND
Diethylphthalate	UG/KG	ND	ND	ND	ND	ND	ND	ND	ND	ND
4-Chlorophenyl phenyl ether	UG/KG	ND	ND	ND	ND	ND	ND	ND	ND	ND
Fluorene	UG/KG	ND	ND	ND	ND	ND	ND	ND	ND	ND
4-Nitroaniline	UG/KG	ND	ND	ND	ND	ND	ND	ND	ND	ND
4,6-Dinitro-2-methylphenol	UG/KG	ND	ND	ND	ND	ND	ND	ND	ND	ND
N-nitrosodiphenylamine	UG/KG	ND	ND	ND	ND	ND	ND	ND	ND	ND
4-Bromophenyl-phenylether	UG/KG	ND	ND	ND	ND	ND	ND	ND	ND	ND
Hexachlorobenzene	UG/KG	ND	ND	ND	ND	ND	ND	ND	ND	ND
Pentachlorophenol	UG/KG	ND	ND	ND	ND	ND	ND	ND	ND	ND
Phenanthrene	UG/KG	ND	ND	ND	ND	ND	ND	ND	ND	ND
Anthracene	UG/KG	ND	ND	ND	ND	ND	ND	ND	ND	ND

UG/KG - micrograms per kilogram

J - estimated

ND - not detected

NJ - tentatively identified

R - rejected

TABLE 5-5
SUBSURFACE SOIL - POSITIVE DETECTION SUMMARY
SITE 1, FRENCH CREEK LIQUIDS DISPOSAL AREA
REMEDIAL INVESTIGATION CTO-0231
MCB, CAMP LEJEUNE, NORTH CAROLINA
TCL ORGANICS

Sample ID:	1-S-SB17-03	1-S-SB18-07	1-N-SB20-05	1-N-SB21-07	1-N-SB22-01	1-N-SB22-06	1-N-SB22-08	1-N-SB24-04	1-N-SB24-07
Sample Depth:	5-7'	13-15'	9-11'	13-15'	1-3'	11-13'	15-17'	7-9'	13-15'
Date Sampled:	3/30/94	4/5/94	3/29/94	3/29/94	4/5/94	4/5/94	4/5/94	3/29/94	3/29/94

UNITS

SEMIVOLATILES Cont.

	UG/KG	ND	ND	ND	ND	ND	ND	ND	ND	ND
Carbazole	UG/KG	ND	ND	ND	ND	ND	ND	ND	ND	ND
di-n-Butylphthalate	UG/KG	ND	ND	ND	ND	ND	ND	ND	ND	ND
Fluoranthene	UG/KG	ND	ND	ND	ND	ND	ND	ND	ND	ND
Pyrene	UG/KG	ND	ND	ND	ND	ND	ND	ND	ND	ND
Butyl benzyl phthalate	UG/KG	ND	ND	ND	ND	ND	ND	ND	ND	ND
3,3'-Dichlorobenzidine	UG/KG	ND	ND	ND	ND	ND	ND	ND	ND	ND
Benzo[a]anthracene	UG/KG	ND	ND	ND	ND	ND	ND	ND	ND	ND
Chrysene	UG/KG	ND	ND	ND	ND	ND	ND	ND	ND	ND
bis(2-Ethylhexyl)phthalate	UG/KG	100 J	ND	ND	ND	ND	ND	ND	900 J	ND
di-n-Octylphthalate	UG/KG	ND	ND	390 R	400 R	ND	ND	ND	ND	390 R
Benzo[b]fluoranthene	UG/KG	ND	ND	ND	ND	ND	ND	ND	ND	ND
Benzo[k]fluoranthene	UG/KG	ND	ND	ND	ND	ND	ND	ND	ND	ND
Benzo[a]pyrene	UG/KG	ND	ND	ND	ND	ND	ND	ND	ND	ND
Indeno[1,2,3-cd]pyrene	UG/KG	ND	ND	ND	ND	ND	ND	ND	ND	ND
Dibenz[a,h]anthracene	UG/KG	ND	ND	ND	ND	ND	ND	ND	ND	ND
Benzo[g,h,i]perylene	UG/KG	ND	ND	ND	ND	ND	ND	ND	ND	ND

PESTICIDE/PCBs

alpha-BHC	UG/KG	ND	ND	ND	ND	ND	ND	ND	ND	ND
beta-BHC	UG/KG	ND	ND	ND	ND	ND	ND	ND	ND	ND
delta-BHC	UG/KG	ND	ND	ND	ND	ND	ND	ND	ND	ND
Lindane (gamma-BHC)	UG/KG	ND	ND	ND	ND	ND	ND	ND	ND	ND
Heptachlor	UG/KG	ND	ND	ND	ND	ND	ND	ND	ND	ND
Aldrin	UG/KG	ND	ND	ND	ND	ND	ND	ND	ND	ND
Heptachlor epoxide	UG/KG	ND	ND	ND	ND	ND	ND	ND	ND	ND
Endosulfan I	UG/KG	ND	ND	ND	ND	ND	ND	ND	ND	ND
Dieldrin	UG/KG	ND	ND	ND	ND	ND	ND	ND	ND	ND
4,4'-DDE	UG/KG	ND	ND	ND	ND	ND	ND	ND	ND	ND

UG/KG - micrograms per kilogram

J - estimated

ND - not detected

NJ - tentatively identified

R - rejected

TABLE 5-5
SUBSURFACE SOIL - POSITIVE DETECTION SUMMARY
SITE 1, FRENCH CREEK LIQUIDS DISPOSAL AREA
REMEDIAL INVESTIGATION CTO-0231
MCB, CAMP LEJEUNE, NORTH CAROLINA
TCL ORGANICS

Sample ID:	1-S-SB17-03	1-S-SB18-07	1-N-SB20-05	1-N-SB21-07	1-N-SB22-01	1-N-SB22-06	1-N-SB22-08	1-N-SB24-04	1-N-SB24-07
Sample Depth:	5-7'	13-15'	9-11'	13-15'	1-3'	11-13'	15-17'	7-9'	13-15'
Date Sampled:	3/30/94	4/5/94	3/29/94	3/29/94	4/5/94	4/5/94	4/5/94	3/29/94	3/29/94

UNITS

PESTICIDE/PCBs Cont.

Endrin	UG/KG	ND	ND	ND	ND	ND	ND	ND	ND	ND
Endosulfan II	UG/KG	ND	ND	ND	ND	ND	ND	ND	ND	ND
4,4'-DDD	UG/KG	ND	ND	ND	ND	2.2 J	ND	ND	ND	ND
Endosulfan sulfate	UG/KG	ND	ND	ND	ND	ND	ND	ND	ND	ND
4,4'-DDT	UG/KG	ND	ND	ND	ND	12 J	ND	ND	ND	ND
Methoxychlor	UG/KG	ND	ND	ND	ND	ND	ND	ND	ND	ND
Endrin ketone	UG/KG	ND	ND	ND	ND	ND	ND	ND	ND	ND
Endrin aldehyde	UG/KG	ND	ND	ND	ND	ND	ND	ND	ND	ND
alpha-Chlordane	UG/KG	ND	ND	ND	ND	ND	ND	ND	ND	ND
gamma-Chlordane	UG/KG	ND	ND	ND	ND	ND	ND	ND	ND	ND
Toxaphene	UG/KG	ND	ND	ND	ND	ND	ND	ND	ND	ND
Aroclor 1016	UG/KG	ND	ND	ND	ND	ND	ND	ND	ND	ND
Aroclor 1221	UG/KG	ND	ND	ND	ND	ND	ND	ND	ND	ND
Aroclor 1232	UG/KG	ND	ND	ND	ND	ND	ND	ND	ND	ND
Aroclor 1242	UG/KG	ND	ND	ND	ND	ND	ND	ND	ND	ND
Aroclor 1248	UG/KG	ND	ND	ND	ND	ND	ND	ND	ND	ND
Aroclor 1254	UG/KG	ND	ND	ND	ND	ND	ND	ND	ND	ND
Aroclor 1260	UG/KG	ND	ND	ND	ND	ND	ND	ND	ND	ND

UG/KG - micrograms per kilogram

J - estimated

ND - not detected

NJ - tentatively identified

R - rejected

TABLE 5-5
SUBSURFACE SOIL - POSITIVE DETECTION SUMMARY
SITE 1, FRENCH CREEK LIQUIDS DISPOSAL AREA
REMEDIAL INVESTIGATION CTO-0231
MCB, CAMP LEJEUNE, NORTH CAROLINA
TCL ORGANICS

Sample ID:	1-N-SB25-01	1-N-SB26-01	1-N-SB26-04	1-N-SB28-01	1-N-SB28-04	1-N-SB32-04	1-N-SB32-07	1-N-SB33-01
Sample Depth:	1-3'	1-3'	7-9'	1-3'	7-9'	7-9'	13-15'	1-3'
Date Sampled:	3/29/94	3/29/94	3/29/94	3/29/94	3/29/94	4/5/94	4/5/94	4/18/94

UNITS

VOLATILES

Compound	UG/KG	1-N-SB25-01	1-N-SB26-01	1-N-SB26-04	1-N-SB28-01	1-N-SB28-04	1-N-SB32-04	1-N-SB32-07	1-N-SB33-01
Methylene chloride	UG/KG	ND	ND	ND	ND	ND	ND	ND	ND
Acetone	UG/KG	ND	ND	ND	ND	ND	ND	9 J	ND
Trichloroethene	UG/KG	ND	ND	ND	ND	ND	ND	3 J	ND
1,1,2,2-Tetrachloroethane	UG/KG	ND	ND	ND	ND	ND	ND	ND	ND
Toluene	UG/KG	ND	ND	ND	ND	ND	ND	ND	ND
Xylenes (total)	UG/KG	ND	ND	ND	ND	ND	ND	ND	ND

SEMIVOLATILES

Compound	UG/KG	1-N-SB25-01	1-N-SB26-01	1-N-SB26-04	1-N-SB28-01	1-N-SB28-04	1-N-SB32-04	1-N-SB32-07	1-N-SB33-01
Phenol	UG/KG	ND	ND	ND	ND	ND	360 R	370 R	ND
bis(2-Chloroethyl) ether	UG/KG	ND	ND	ND	ND	ND	360 R	370 R	ND
2-Chlorophenol	UG/KG	ND	ND	ND	ND	ND	360 R	370 R	ND
1,3-Dichlorobenzene	UG/KG	ND	ND	ND	ND	ND	360 R	370 R	ND
1,4-Dichlorobenzene	UG/KG	ND	ND	ND	ND	ND	360 R	370 R	ND
1,2-Dichlorobenzene	UG/KG	ND	ND	ND	ND	ND	360 R	370 R	ND
2-Methylphenol	UG/KG	ND	ND	ND	ND	ND	360 R	370 R	ND
2,2'-oxybis-(1-chloropropane)	UG/KG	ND	ND	ND	ND	ND	360 R	370 R	ND
4-Methylphenol	UG/KG	ND	ND	ND	ND	ND	360 R	370 R	ND
N-Nitroso-di-n-propylamine	UG/KG	ND	ND	ND	ND	ND	360 R	370 R	ND
Hexachloroethane	UG/KG	ND	ND	ND	ND	ND	360 R	370 R	ND
Nitrobenzene	UG/KG	ND	ND	ND	ND	ND	360 R	370 R	ND
Isophorone	UG/KG	ND	ND	ND	ND	ND	360 R	370 R	ND
2-Nitrophenol	UG/KG	ND	ND	ND	ND	ND	360 R	370 R	ND
2,4-Dimethylphenol	UG/KG	ND	ND	ND	ND	ND	360 R	370 R	ND
bis(2-Chloroethoxy) methane	UG/KG	ND	ND	ND	ND	ND	360 R	370 R	ND
2,4-Dichlorophenol	UG/KG	ND	ND	ND	ND	ND	360 R	370 R	ND
1,2,4-Trichlorobenzene	UG/KG	ND	ND	ND	ND	ND	360 R	370 R	ND
Naphthalene	UG/KG	ND	ND	ND	ND	ND	360 R	370 R	ND
4-Chloroaniline	UG/KG	ND	ND	ND	ND	ND	360 R	370 R	ND

UG/KG - micrograms per kilogram

J - estimated

ND - not detected

NJ - tentatively identified

R - rejected

TABLE 5-5
SUBSURFACE SOIL - POSITIVE DETECTION SUMMARY
SITE 1, FRENCH CREEK LIQUIDS DISPOSAL AREA
REMEDIAL INVESTIGATION CTO-0231
MCB, CAMP LEJEUNE, NORTH CAROLINA
TCL ORGANICS

Sample ID:	1-N-SB25-01	1-N-SB26-01	1-N-SB26-04	1-N-SB28-01	1-N-SB28-04	1-N-SB32-04	1-N-SB32-07	1-N-SB33-01
Sample Depth:	1-3'	1-3'	7-9'	1-3'	7-9'	7-9'	13-15'	1-3'
Date Sampled:	3/29/94	3/29/94	3/29/94	3/29/94	3/29/94	4/5/94	4/5/94	4/18/94

UNITS

SEMIVOLATILES Cont.

Hexachlorobutadiene	UG/KG	ND	ND	ND	ND	ND	360 R	370 R	ND
4-Chloro-3-methylphenol	UG/KG	ND	ND	ND	ND	ND	360 R	370 R	ND
2-Methylnaphthalene	UG/KG	ND	ND	ND	ND	ND	360 R	370 R	ND
Hexachlorocyclopentadiene	UG/KG	ND	ND	ND	ND	ND	360 R	370 R	ND
2,4,6-Trichlorophenol	UG/KG	ND	ND	ND	ND	ND	360 R	370 R	ND
2,4,5-Trichlorophenol	UG/KG	ND	ND	ND	ND	ND	870 R	900 R	ND
2-Chloronaphthalene	UG/KG	ND	ND	ND	ND	ND	360 R	370 R	ND
2-Nitroaniline	UG/KG	ND	ND	ND	ND	ND	870 R	900 R	ND
Dimethyl phthalate	UG/KG	ND	ND	ND	ND	ND	360 R	370 R	ND
Acenaphthylene	UG/KG	ND	ND	ND	ND	ND	360 R	370 R	ND
2,6-Dinitrotoluene	UG/KG	ND	ND	ND	ND	ND	360 R	370 R	ND
3-Nitroaniline	UG/KG	ND	ND	ND	ND	ND	870 R	900 R	ND
Acenaphthene	UG/KG	ND	ND	ND	ND	ND	360 R	370 R	ND
2,4-Dinitrophenol	UG/KG	ND	ND	ND	ND	ND	870 R	900 R	ND
4-Nitrophenol	UG/KG	ND	ND	ND	ND	ND	870 R	900 R	ND
Dibenzofuran	UG/KG	ND	ND	ND	ND	ND	360 R	370 R	ND
2,4-Dinitrotoluene	UG/KG	ND	ND	ND	ND	ND	360 R	370 R	ND
Diethylphthalate	UG/KG	ND	ND	ND	ND	ND	360 R	370 R	ND
4-Chlorophenyl phenyl ether	UG/KG	ND	ND	ND	ND	ND	360 R	370 R	ND
Fluorene	UG/KG	ND	ND	ND	ND	ND	360 R	370 R	ND
4-Nitroaniline	UG/KG	ND	ND	ND	ND	ND	870 R	900 R	ND
4,6-Dinitro-2-methylphenol	UG/KG	ND	ND	ND	ND	ND	870 R	900 R	ND
N-nitrosodiphenylamine	UG/KG	ND	ND	ND	ND	ND	360 R	370 R	ND
4-Bromophenyl-phenylether	UG/KG	ND	ND	ND	ND	ND	360 R	370 R	ND
Hexachlorobenzene	UG/KG	ND	ND	ND	ND	ND	360 R	370 R	ND
Pentachlorophenol	UG/KG	ND	ND	ND	ND	ND	870 R	900 R	ND
Phenanthrene	UG/KG	ND	ND	ND	ND	ND	64 R	370 R	ND
Anthracene	UG/KG	ND	ND	ND	ND	ND	360 R	370 R	ND

UG/KG - micrograms per kilogram

J - estimated

ND - not detected

NJ - tentatively identified

R - rejected

TABLE 5-5
SUBSURFACE SOIL - POSITIVE DETECTION SUMMARY
SITE 1, FRENCH CREEK LIQUIDS DISPOSAL AREA
REMEDIAL INVESTIGATION CTO-0231
MCB, CAMP LEJEUNE, NORTH CAROLINA
TCL ORGANICS

Sample ID:	1-N-SB25-01	1-N-SB26-01	1-N-SB26-04	1-N-SB28-01	1-N-SB28-04	1-N-SB32-04	1-N-SB32-07	1-N-SB33-01
Sample Depth:	1-3'	1-3'	7-9'	1-3'	7-9'	7-9'	13-15'	1-3'
Date Sampled:	3/29/94	3/29/94	3/29/94	3/29/94	3/29/94	4/5/94	4/5/94	4/18/94

UNITS

SEMIVOLATILES Cont.

Carbazole	UG/KG	ND	ND	ND	ND	ND	360 R	370 R	ND
di-n-Butylphthalate	UG/KG	ND	ND	ND	ND	ND	360 R	370 R	ND
Fluoranthene	UG/KG	ND	ND	ND	ND	ND	360 R	370 R	ND
Pyrene	UG/KG	ND	ND	ND	ND	ND	360 R	370 R	ND
Butyl benzyl phthalate	UG/KG	ND	ND	ND	ND	ND	360 R	370 R	ND
3,3'-Dichlorobenzidine	UG/KG	ND	ND	ND	ND	ND	360 R	370 R	ND
Benzo[a]anthracene	UG/KG	ND	ND	ND	ND	ND	360 R	370 R	ND
Chrysene	UG/KG	ND	ND	ND	ND	ND	360 R	370 R	ND
bis(2-Ethylhexyl)phthalate	UG/KG	860	ND	8700	550	2700	360 R	370 R	36 J
di-n-Octylphthalate	UG/KG	ND	ND	ND	ND	ND	360 R	370 R	ND
Benzo[b]fluoranthene	UG/KG	ND	ND	ND	ND	ND	360 R	370 R	ND
Benzo[k]fluoranthene	UG/KG	ND	ND	ND	ND	ND	360 R	370 R	ND
Benzo[a]pyrene	UG/KG	ND	ND	ND	ND	ND	360 R	370 R	ND
Indeno[1,2,3-cd]pyrene	UG/KG	ND	ND	ND	ND	ND	360 R	370 R	ND
Dibenz[a,h]anthracene	UG/KG	ND	ND	ND	ND	ND	360 R	370 R	ND
Benzo[g,h,i]perylene	UG/KG	ND	ND	ND	ND	ND	360 R	370 R	ND

PESTICIDE/PCBs

alpha-BHC	UG/KG	ND	ND	ND	ND	ND	ND	ND	ND
beta-BHC	UG/KG	ND	ND	ND	ND	ND	ND	ND	ND
delta-BHC	UG/KG	ND	ND	ND	ND	ND	ND	ND	ND
Lindane (gamma-BHC)	UG/KG	ND	ND	ND	ND	ND	ND	ND	ND
Heptachlor	UG/KG	ND	ND	ND	ND	ND	ND	ND	ND
Aldrin	UG/KG	ND	ND	ND	ND	ND	ND	ND	ND
Heptachlor epoxide	UG/KG	ND	ND	ND	ND	ND	ND	ND	ND
Endosulfan I	UG/KG	ND	ND	ND	ND	ND	ND	ND	ND
Dieldrin	UG/KG	ND	39 J	ND	ND	ND	ND	ND	ND
4,4'-DDE	UG/KG	ND	120	ND	ND	ND	ND	ND	ND

UG/KG - micrograms per kilogram

J - estimated

ND - not detected

NJ - tentatively identified

R - rejected

TABLE 5-5
SUBSURFACE SOIL - POSITIVE DETECTION SUMMARY
SITE 1, FRENCH CREEK LIQUIDS DISPOSAL AREA
REMEDIAL INVESTIGATION CTO-0231
MCB, CAMP LEJEUNE, NORTH CAROLINA
TCL ORGANICS

Sample ID:	1-N-SB25-01	1-N-SB26-01	1-N-SB26-04	1-N-SB28-01	1-N-SB28-04	1-N-SB32-04	1-N-SB32-07	1-N-SB33-01
Sample Depth:	1-3'	1-3'	7-9'	1-3'	7-9'	7-9'	13-15'	1-3'
Date Sampled:	3/29/94	3/29/94	3/29/94	3/29/94	3/29/94	4/5/94	4/5/94	4/18/94

UNITS

PESTICIDE/PCBs Cont.

	UG/KG	1-N-SB25-01	1-N-SB26-01	1-N-SB26-04	1-N-SB28-01	1-N-SB28-04	1-N-SB32-04	1-N-SB32-07	1-N-SB33-01
Endrin	UG/KG	ND	ND	ND	ND	ND	ND	ND	ND
Endosulfan II	UG/KG	ND	ND	ND	ND	ND	ND	ND	ND
4,4'-DDD	UG/KG	ND	28 J	ND	ND	ND	ND	ND	ND
Endosulfan sulfate	UG/KG	ND	ND	ND	ND	ND	ND	ND	ND
4,4'-DDT	UG/KG	ND	18 J	ND	ND	ND	ND	ND	ND
Methoxychlor	UG/KG	ND	ND	ND	ND	ND	ND	ND	ND
Endrin ketone	UG/KG	ND	ND	ND	ND	ND	ND	ND	ND
Endrin aldehyde	UG/KG	ND	ND	ND	ND	ND	ND	ND	ND
alpha-Chlordane	UG/KG	ND	4.2 NJ	ND	ND	ND	ND	ND	ND
gamma-Chlordane	UG/KG	ND	2.9 NJ	ND	ND	ND	ND	ND	ND
Toxaphene	UG/KG	ND	ND	ND	ND	ND	ND	ND	ND
Aroclor 1016	UG/KG	ND	ND	ND	ND	ND	ND	ND	ND
Aroclor 1221	UG/KG	ND	ND	ND	ND	ND	ND	ND	ND
Aroclor 1232	UG/KG	ND	ND	ND	ND	ND	ND	ND	ND
Aroclor 1242	UG/KG	ND	ND	ND	ND	ND	ND	ND	ND
Aroclor 1248	UG/KG	ND	ND	ND	ND	ND	ND	ND	ND
Aroclor 1254	UG/KG	ND	ND	ND	ND	ND	ND	ND	ND
Aroclor 1260	UG/KG	ND	ND	ND	ND	ND	ND	ND	ND

UG/KG - micrograms per kilogram

J - estimated

ND - not detected

NJ - tentatively identified

R - rejected

TABLE 5-5
SUBSURFACE SOIL - POSITIVE DETECTION SUMMARY
SITE 1, FRENCH CREEK LIQUIDS DISPOSAL AREA
REMEDIAL INVESTIGATION CTO-0231
MCB, CAMP LEJEUNE, NORTH CAROLINA
TCL ORGANICS

Sample ID:	1-N-SB33-04	1-N-SB33-07	1-N-SB34-01	1-N-SB34-03	1-N-SB34-07	1-N-SB35-01	1-N-SB35-06	1-N-SB36-01
Sample Depth:	7-9'	13-15'	1-3'	5-7'	13-15'	1-3'	11-13'	1-3'
Date Sampled:	4/18/94	4/18/94	3/29/94	3/29/94	3/29/94	3/29/94	3/29/94	3/29/94

UNITS

VOLATILES

	UG/KG	1-N-SB33-04	1-N-SB33-07	1-N-SB34-01	1-N-SB34-03	1-N-SB34-07	1-N-SB35-01	1-N-SB35-06	1-N-SB36-01
Methylene chloride	UG/KG	ND	ND	ND	ND	ND	ND	ND	ND
Acetone	UG/KG	ND	ND	12	15	32	ND	30	ND
Trichloroethene	UG/KG	ND	ND	ND	ND	ND	ND	ND	ND
1,1,2,2-Tetrachloroethane	UG/KG	ND	ND	ND	ND	ND	ND	ND	ND
Toluene	UG/KG	ND	ND	ND	ND	ND	ND	ND	ND
Xylenes (total)	UG/KG	ND	ND	ND	ND	ND	ND	ND	ND

SEMIVOLATILES

	UG/KG	1-N-SB33-04	1-N-SB33-07	1-N-SB34-01	1-N-SB34-03	1-N-SB34-07	1-N-SB35-01	1-N-SB35-06	1-N-SB36-01
Phenol	UG/KG	ND	ND	ND	ND	ND	ND	ND	ND
bis(2-Chloroethyl) ether	UG/KG	ND	ND	ND	ND	ND	ND	ND	ND
2-Chlorophenol	UG/KG	ND	ND	ND	ND	ND	ND	ND	ND
1,3-Dichlorobenzene	UG/KG	ND	ND	ND	ND	ND	ND	ND	ND
1,4-Dichlorobenzene	UG/KG	ND	ND	ND	ND	ND	ND	ND	ND
1,2-Dichlorobenzene	UG/KG	ND	ND	ND	ND	ND	ND	ND	ND
2-Methylphenol	UG/KG	ND	ND	ND	ND	ND	ND	ND	ND
2,2'-oxybis-(1-chloropropane)	UG/KG	ND	ND	ND	ND	ND	ND	ND	ND
4-Methylphenol	UG/KG	ND	ND	ND	ND	ND	ND	ND	ND
N-Nitroso-di-n-propylamine	UG/KG	ND	ND	ND	ND	ND	ND	ND	ND
Hexachloroethane	UG/KG	ND	ND	ND	ND	ND	ND	ND	ND
Nitrobenzene	UG/KG	ND	ND	ND	ND	ND	ND	ND	ND
Isophorone	UG/KG	ND	ND	ND	ND	ND	ND	ND	ND
2-Nitrophenol	UG/KG	ND	ND	ND	ND	ND	ND	ND	ND
2,4-Dimethylphenol	UG/KG	ND	ND	ND	ND	ND	ND	ND	ND
bis(2-Chloroethoxy) methane	UG/KG	ND	ND	ND	ND	ND	ND	ND	ND
2,4-Dichlorophenol	UG/KG	ND	ND	ND	ND	ND	ND	ND	ND
1,2,4-Trichlorobenzene	UG/KG	ND	ND	ND	ND	ND	ND	ND	ND
Naphthalene	UG/KG	ND	ND	ND	ND	ND	ND	ND	ND
4-Chloroaniline	UG/KG	ND	ND	ND	ND	ND	ND	ND	ND

UG/KG - micrograms per kilogram

J - estimated

ND - not detected

NJ - tentatively identified

R - rejected

TABLE 5-5
SUBSURFACE SOIL - POSITIVE DETECTION SUMMARY
SITE 1, FRENCH CREEK LIQUIDS DISPOSAL AREA
REMEDIAL INVESTIGATION CTO-0231
MCB, CAMP LEJEUNE, NORTH CAROLINA
TCL ORGANICS

Sample ID:	1-N-SB33-04	1-N-SB33-07	1-N-SB34-01	1-N-SB34-03	1-N-SB34-07	1-N-SB35-01	1-N-SB35-06	1-N-SB36-01
Sample Depth:	7-9'	13-15'	1-3'	5-7'	13-15'	1-3'	11-13'	1-3'
Date Sampled:	4/18/94	4/18/94	3/29/94	3/29/94	3/29/94	3/29/94	3/29/94	3/29/94

UNITS

SEMIVOLATILES Cont.

	1-N-SB33-04	1-N-SB33-07	1-N-SB34-01	1-N-SB34-03	1-N-SB34-07	1-N-SB35-01	1-N-SB35-06	1-N-SB36-01
Hexachlorobutadiene	UG/KG	ND	ND	ND	ND	ND	ND	ND
4-Chloro-3-methylphenol	UG/KG	ND	ND	ND	ND	ND	ND	ND
2-Methylnaphthalene	UG/KG	ND	ND	ND	ND	ND	ND	ND
Hexachlorocyclopentadiene	UG/KG	ND	ND	ND	ND	ND	ND	ND
2,4,6-Trichlorophenol	UG/KG	ND	ND	ND	ND	ND	ND	ND
2,4,5-Trichlorophenol	UG/KG	ND	ND	ND	ND	ND	ND	ND
2-Chloronaphthalene	UG/KG	ND	ND	ND	ND	ND	ND	ND
2-Nitroaniline	UG/KG	ND	ND	ND	ND	ND	ND	ND
Dimethyl phthalate	UG/KG	ND	ND	ND	ND	ND	ND	ND
Acenaphthylene	UG/KG	ND	ND	ND	ND	ND	ND	ND
2,6-Dinitrotoluene	UG/KG	ND	ND	ND	ND	ND	ND	ND
3-Nitroaniline	UG/KG	ND	ND	ND	ND	ND	ND	ND
Acenaphthene	UG/KG	ND	ND	ND	ND	ND	ND	ND
2,4-Dinitrophenol	UG/KG	ND	ND	ND	ND	ND	ND	ND
4-Nitrophenol	UG/KG	ND	ND	ND	ND	ND	ND	ND
Dibenzofuran	UG/KG	ND	ND	ND	ND	ND	ND	ND
2,4-Dinitrotoluene	UG/KG	ND	ND	ND	ND	ND	ND	ND
Diethylphthalate	UG/KG	ND	ND	ND	ND	ND	ND	ND
4-Chlorophenyl phenyl ether	UG/KG	ND	ND	ND	ND	ND	ND	ND
Fluorene	UG/KG	ND	ND	ND	ND	ND	ND	ND
4-Nitroaniline	UG/KG	ND	ND	ND	ND	ND	ND	ND
4,6-Dinitro-2-methylphenol	UG/KG	ND	ND	ND	ND	ND	ND	ND
N-nitrosodiphenylamine	UG/KG	ND	ND	ND	ND	ND	ND	ND
4-Bromophenyl-phenylether	UG/KG	ND	ND	ND	ND	ND	ND	ND
Hexachlorobenzene	UG/KG	ND	ND	ND	ND	ND	ND	ND
Pentachlorophenol	UG/KG	ND	ND	ND	ND	ND	ND	ND
Phenanthrene	UG/KG	ND	ND	ND	ND	ND	ND	ND
Anthracene	UG/KG	ND	ND	ND	ND	ND	ND	ND

UG/KG - micrograms per kilogram

J - estimated

ND - not detected

NJ - tentatively identified

R - rejected

TABLE 5-5
SUBSURFACE SOIL - POSITIVE DETECTION SUMMARY
SITE 1, FRENCH CREEK LIQUIDS DISPOSAL AREA
REMEDIAL INVESTIGATION CTO-0231
MCB, CAMP LEJEUNE, NORTH CAROLINA
TCL ORGANICS

Sample ID:	1-N-SB33-04	1-N-SB33-07	1-N-SB34-01	1-N-SB34-03	1-N-SB34-07	1-N-SB35-01	1-N-SB35-06	1-N-SB36-01
Sample Depth:	7-9'	13-15'	1-3'	5-7'	13-15'	1-3'	11-13'	1-3'
Date Sampled:	4/18/94	4/18/94	3/29/94	3/29/94	3/29/94	3/29/94	3/29/94	3/29/94

UNITS

SEMIVOLATILES Cont.

	UG/KG	1-N-SB33-04	1-N-SB33-07	1-N-SB34-01	1-N-SB34-03	1-N-SB34-07	1-N-SB35-01	1-N-SB35-06	1-N-SB36-01
Carbazole	UG/KG	ND	ND	ND	ND	ND	ND	ND	ND
di-n-Butylphthalate	UG/KG	74 J	ND	ND	ND	ND	ND	ND	ND
Fluoranthene	UG/KG	ND	ND	ND	ND	ND	ND	ND	ND
Pyrene	UG/KG	ND	ND	ND	ND	ND	ND	ND	ND
Butyl benzyl phthalate	UG/KG	ND	ND	ND	ND	ND	ND	ND	ND
3,3'-Dichlorobenzidine	UG/KG	ND	ND	ND	ND	ND	ND	ND	ND
Benzo[a]anthracene	UG/KG	ND	ND	ND	ND	ND	ND	ND	ND
Chrysene	UG/KG	ND	ND	ND	ND	ND	ND	ND	ND
bis(2-Ethylhexyl)phthalate	UG/KG	150 J	240 J	ND	ND	ND	2200 J	ND	8600 R
di-n-Octylphthalate	UG/KG	ND	ND	ND	ND	ND	ND	ND	ND
Benzo[b]fluoranthene	UG/KG	ND	ND	ND	ND	ND	ND	ND	ND
Benzo[k]fluoranthene	UG/KG	ND	ND	ND	ND	ND	ND	ND	ND
Benzo[a]pyrene	UG/KG	ND	ND	ND	ND	ND	ND	ND	ND
Indeno[1,2,3-cd]pyrene	UG/KG	ND	ND	ND	ND	ND	ND	ND	ND
Dibenz[a,h]anthracene	UG/KG	ND	ND	ND	ND	ND	ND	ND	ND
Benzo[g,h,i]perylene	UG/KG	ND	ND	ND	ND	ND	ND	ND	ND

PESTICIDE/PCBs

	UG/KG	1-N-SB33-04	1-N-SB33-07	1-N-SB34-01	1-N-SB34-03	1-N-SB34-07	1-N-SB35-01	1-N-SB35-06	1-N-SB36-01
alpha-BHC	UG/KG	ND	ND	ND	ND	ND	ND	ND	ND
beta-BHC	UG/KG	ND	ND	ND	ND	ND	ND	ND	ND
delta-BHC	UG/KG	ND	ND	ND	ND	ND	ND	ND	ND
Lindane (gamma-BHC)	UG/KG	ND	ND	ND	ND	ND	ND	ND	ND
Heptachlor	UG/KG	ND	ND	ND	ND	ND	ND	ND	ND
Aldrin	UG/KG	ND	ND	ND	ND	ND	ND	ND	ND
Heptachlor epoxide	UG/KG	ND	ND	ND	ND	ND	ND	ND	ND
Endosulfan I	UG/KG	ND	ND	ND	ND	ND	ND	ND	ND
Dieldrin	UG/KG	ND	ND	ND	ND	ND	ND	ND	ND
4,4'-DDE	UG/KG	ND	ND	ND	ND	ND	ND	ND	ND

UG/KG - micrograms per kilogram

J - estimated

ND - not detected

NJ - tentatively identified

R - rejected

TABLE 5-5
SUBSURFACE SOIL - POSITIVE DETECTION SUMMARY
SITE 1, FRENCH CREEK LIQUIDS DISPOSAL AREA
REMEDIAL INVESTIGATION CTO-0231
MCB, CAMP LEJEUNE, NORTH CAROLINA
TCL ORGANICS

Sample ID:	1-N-SB33-04	1-N-SB33-07	1-N-SB34-01	1-N-SB34-03	1-N-SB34-07	1-N-SB35-01	1-N-SB35-06	1-N-SB36-01
Sample Depth:	7-9'	13-15'	1-3'	5-7'	13-15'	1-3'	11-13'	1-3'
Date Sampled:	4/18/94	4/18/94	3/29/94	3/29/94	3/29/94	3/29/94	3/29/94	3/29/94

UNITS

PESTICIDE/PCBs Cont.

	UG/KG	1-N-SB33-04	1-N-SB33-07	1-N-SB34-01	1-N-SB34-03	1-N-SB34-07	1-N-SB35-01	1-N-SB35-06	1-N-SB36-01
Endrin	UG/KG	ND	ND	ND	ND	ND	ND	ND	ND
Endosulfan II	UG/KG	ND	ND	ND	ND	ND	55	ND	ND
4,4'-DDD	UG/KG	ND	ND	ND	ND	ND	ND	ND	ND
Endosulfan sulfate	UG/KG	ND	ND	ND	ND	ND	ND	ND	ND
4,4'-DDT	UG/KG	ND	ND	6.2 J	3.8	ND	ND	ND	ND
Methoxychlor	UG/KG	ND	ND	ND	ND	ND	ND	ND	ND
Endrin ketone	UG/KG	ND	ND	ND	ND	ND	ND	ND	ND
Endrin aldehyde	UG/KG	ND	ND	ND	ND	ND	24 NJ	ND	ND
alpha-Chlordane	UG/KG	ND	ND	ND	ND	ND	ND	ND	ND
gamma-Chlordane	UG/KG	ND	ND	ND	ND	ND	ND	ND	ND
Toxaphene	UG/KG	ND	ND	ND	ND	ND	ND	ND	ND
Aroclor 1016	UG/KG	ND	ND	ND	ND	ND	ND	ND	ND
Aroclor 1221	UG/KG	ND	ND	ND	ND	ND	ND	ND	ND
Aroclor 1232	UG/KG	ND	ND	ND	ND	ND	ND	ND	ND
Aroclor 1242	UG/KG	ND	ND	ND	ND	ND	ND	ND	ND
Aroclor 1248	UG/KG	ND	ND	ND	ND	ND	ND	ND	ND
Aroclor 1254	UG/KG	ND	ND	ND	ND	ND	ND	ND	ND
Aroclor 1260	UG/KG	ND	ND	ND	ND	ND	1300	ND	ND

UG/KG - micrograms per kilogram

J - estimated

ND - not detected

NJ - tentatively identified

R - rejected

TABLE 5-5
SUBSURFACE SOIL - POSITIVE DETECTION SUMMARY
SITE 1, FRENCH CREEK LIQUIDS DISPOSAL AREA
REMEDIAL INVESTIGATION CTO-0231
MCB, CAMP LEJEUNE, NORTH CAROLINA
TCL ORGANICS

Sample ID:	1-N-SB36-06	1-N-SB37-02	1-GW07-03	1-GW08-03	1-GW09-03	1-GW11-01	1-GW12-02	1-GW16-04	1-GW16-06
Sample Depth:	11-13'	3-5'	5-7'	5-7'	5-7'	1-3'	3-5'	7-9'	11-13'
Date Sampled:	3/29/94	3/29/94	4/12/94	4/12/94	4/10/94	4/10/94	4/10/94	4/13/94	4/13/94

UNITS

VOLATILES

	UG/KG	1-N-SB36-06	1-N-SB37-02	1-GW07-03	1-GW08-03	1-GW09-03	1-GW11-01	1-GW12-02	1-GW16-04	1-GW16-06
Methylene chloride	UG/KG	ND	ND	ND	ND	ND	ND	ND	ND	ND
Acetone	UG/KG	ND	ND	ND	ND	ND	ND	ND	ND	11 J
Trichloroethene	UG/KG	ND	ND	ND	ND	ND	ND	ND	ND	ND
1,1,2,2-Tetrachloroethane	UG/KG	ND	ND	ND	ND	ND	ND	ND	ND	ND
Toluene	UG/KG	ND	ND	ND	ND	ND	ND	ND	ND	ND
Xylenes (total)	UG/KG	ND	ND	ND	ND	ND	ND	ND	ND	ND

SEMIVOLATILES

	UG/KG	1-N-SB36-06	1-N-SB37-02	1-GW07-03	1-GW08-03	1-GW09-03	1-GW11-01	1-GW12-02	1-GW16-04	1-GW16-06
Phenol	UG/KG	ND	ND	ND	ND	ND	ND	ND	ND	ND
bis(2-Chloroethyl) ether	UG/KG	ND	ND	ND	ND	ND	ND	ND	ND	ND
2-Chlorophenol	UG/KG	ND	ND	ND	ND	ND	ND	ND	ND	ND
1,3-Dichlorobenzene	UG/KG	ND	ND	ND	ND	ND	ND	ND	ND	ND
1,4-Dichlorobenzene	UG/KG	ND	ND	ND	ND	ND	ND	ND	ND	ND
1,2-Dichlorobenzene	UG/KG	ND	ND	ND	ND	ND	ND	ND	ND	ND
2-Methylphenol	UG/KG	ND	ND	ND	ND	ND	ND	ND	ND	ND
2,2'-oxybis-(1-chloropropane)	UG/KG	ND	ND	ND	ND	ND	ND	ND	ND	ND
4-Methylphenol	UG/KG	ND	ND	ND	ND	ND	ND	ND	ND	ND
N-Nitroso-di-n-propylamine	UG/KG	ND	ND	ND	ND	ND	ND	ND	ND	ND
Hexachloroethane	UG/KG	ND	ND	ND	ND	ND	ND	ND	ND	ND
Nitrobenzene	UG/KG	ND	ND	ND	ND	ND	ND	ND	ND	ND
Isophorone	UG/KG	ND	ND	ND	ND	ND	ND	ND	ND	ND
2-Nitrophenol	UG/KG	ND	ND	ND	ND	ND	ND	ND	ND	ND
2,4-Dimethylphenol	UG/KG	ND	ND	ND	ND	ND	ND	ND	ND	ND
bis(2-Chloroethoxy) methane	UG/KG	ND	ND	ND	ND	ND	ND	ND	ND	ND
2,4-Dichlorophenol	UG/KG	ND	ND	ND	ND	ND	ND	ND	ND	ND
1,2,4-Trichlorobenzene	UG/KG	ND	ND	ND	ND	ND	ND	ND	ND	ND
Naphthalene	UG/KG	ND	ND	ND	ND	ND	ND	ND	ND	ND
4-Chloroaniline	UG/KG	ND	ND	ND	ND	ND	ND	ND	ND	ND

UG/KG - micrograms per kilogram

J - estimated

ND - not detected

NJ - tentatively identified

R - rejected

TABLE 5-5
SUBSURFACE SOIL - POSITIVE DETECTION SUMMARY
SITE 1, FRENCH CREEK LIQUIDS DISPOSAL AREA
REMEDIAL INVESTIGATION CTO-0231
MCB, CAMP LEJEUNE, NORTH CAROLINA
TCL ORGANICS

Sample ID:	1-N-SB36-06	1-N-SB37-02	1-GW07-03	1-GW08-03	1-GW09-03	1-GW11-01	1-GW12-02	1-GW16-04	1-GW16-06
Sample Depth:	11-13'	3-5'	5-7'	5-7'	5-7'	1-3'	3-5'	7-9'	11-13'
Date Sampled:	3/29/94	3/29/94	4/12/94	4/12/94	4/10/94	4/10/94	4/10/94	4/13/94	4/13/94

UNITS

SEMIVOLATILES Cont.

Hexachlorobutadiene	UG/KG	ND	ND	ND	ND	ND	ND	ND	ND	ND
4-Chloro-3-methylphenol	UG/KG	ND	ND	ND	ND	ND	ND	ND	ND	ND
2-Methylnaphthalene	UG/KG	ND	ND	ND	ND	ND	ND	ND	ND	ND
Hexachlorocyclopentadiene	UG/KG	ND	ND	ND	ND	ND	ND	ND	ND	ND
2,4,6-Trichlorophenol	UG/KG	ND	ND	ND	ND	ND	ND	ND	ND	ND
2,4,5-Trichlorophenol	UG/KG	ND	ND	ND	ND	ND	ND	ND	ND	ND
2-Chloronaphthalene	UG/KG	ND	ND	ND	ND	ND	ND	ND	ND	ND
2-Nitroaniline	UG/KG	ND	ND	ND	ND	ND	ND	ND	ND	ND
Dimethyl phthalate	UG/KG	ND	ND	ND	ND	ND	ND	ND	ND	ND
Acenaphthylene	UG/KG	ND	ND	ND	ND	ND	ND	ND	ND	ND
2,6-Dinitrotoluene	UG/KG	ND	ND	ND	ND	ND	ND	ND	ND	ND
3-Nitroaniline	UG/KG	ND	ND	ND	ND	ND	ND	ND	ND	ND
Acenaphthene	UG/KG	ND	ND	ND	ND	ND	ND	ND	ND	ND
2,4-Dinitrophenol	UG/KG	ND	ND	ND	ND	ND	ND	ND	ND	ND
4-Nitrophenol	UG/KG	ND	ND	ND	ND	ND	ND	ND	ND	ND
Dibenzofuran	UG/KG	ND	ND	ND	ND	ND	ND	ND	ND	ND
2,4-Dinitrotoluene	UG/KG	ND	ND	ND	ND	ND	ND	ND	ND	ND
Diethylphthalate	UG/KG	ND	ND	ND	ND	ND	ND	ND	ND	ND
4-Chlorophenyl phenyl ether	UG/KG	ND	ND	ND	ND	ND	ND	ND	ND	ND
Fluorene	UG/KG	ND	ND	ND	ND	ND	ND	ND	ND	ND
4-Nitroaniline	UG/KG	ND	ND	ND	ND	ND	ND	ND	ND	ND
4,6-Dinitro-2-methylphenol	UG/KG	ND	ND	ND	ND	ND	ND	ND	ND	ND
N-nitrosodiphenylamine	UG/KG	ND	ND	ND	ND	ND	ND	ND	ND	ND
4-Bromophenyl-phenylether	UG/KG	ND	ND	ND	ND	ND	ND	ND	ND	ND
Hexachlorobenzene	UG/KG	ND	ND	ND	ND	ND	ND	ND	ND	ND
Pentachlorophenol	UG/KG	ND	ND	ND	ND	ND	ND	ND	ND	ND
Phenanthrene	UG/KG	47 J	ND	ND	ND	ND	ND	ND	ND	ND
Anthracene	UG/KG	ND	ND	ND	ND	ND	ND	ND	ND	ND

UG/KG - micrograms per kilogram

J - estimated

ND - not detected

NJ - tentatively identified

R - rejected

TABLE 5-5
SUBSURFACE SOIL - POSITIVE DETECTION SUMMARY
SITE 1, FRENCH CREEK LIQUIDS DISPOSAL AREA
REMEDIAL INVESTIGATION CTO-0231
MCB, CAMP LEJEUNE, NORTH CAROLINA
TCL ORGANICS

Sample ID:	1-N-SB36-06	1-N-SB37-02	1-GW07-03	1-GW08-03	1-GW09-03	1-GW11-01	1-GW12-02	1-GW16-04	1-GW16-06
Sample Depth:	11-13'	3-5'	5-7'	5-7'	5-7'	1-3'	3-5'	7-9'	11-13'
Date Sampled:	3/29/94	3/29/94	4/12/94	4/12/94	4/10/94	4/10/94	4/10/94	4/13/94	4/13/94

UNITS

SEMIVOLATILES Cont.

	UG/KG	1-N-SB36-06	1-N-SB37-02	1-GW07-03	1-GW08-03	1-GW09-03	1-GW11-01	1-GW12-02	1-GW16-04	1-GW16-06
Carbazole	UG/KG	ND	ND	ND	ND	ND	ND	ND	ND	ND
di-n-Butylphthalate	UG/KG	ND	ND	ND	ND	ND	ND	ND	ND	ND
Fluoranthene	UG/KG	110 J	ND	ND	ND	ND	ND	ND	ND	ND
Pyrene	UG/KG	86 J	ND	ND	ND	ND	ND	ND	ND	ND
Butyl benzyl phthalate	UG/KG	ND	ND	ND	ND	ND	ND	ND	ND	ND
3,3'-Dichlorobenzidine	UG/KG	ND	ND	ND	ND	ND	ND	ND	ND	ND
Benzo[a]anthracene	UG/KG	ND	ND	ND	ND	ND	ND	ND	ND	ND
Chrysene	UG/KG	ND	ND	ND	ND	ND	ND	ND	ND	ND
bis(2-Ethylhexyl)phthalate	UG/KG	ND	ND	49 J	61 J	39 J	88 J	120 J	ND	ND
di-n-Octylphthalate	UG/KG	ND	ND	ND	ND	ND	ND	ND	ND	ND
Benzo[b]fluoranthene	UG/KG	ND	ND	ND	ND	ND	ND	ND	ND	ND
Benzo[k]fluoranthene	UG/KG	ND	ND	ND	ND	ND	ND	ND	ND	ND
Benzo[a]pyrene	UG/KG	ND	ND	ND	ND	ND	ND	ND	ND	ND
Indeno[1,2,3-cd]pyrene	UG/KG	ND	ND	ND	ND	ND	ND	ND	ND	ND
Dibenz[a,h]anthracene	UG/KG	ND	ND	ND	ND	ND	ND	ND	ND	ND
Benzo[g,h,i]perylene	UG/KG	ND	ND	ND	ND	ND	ND	ND	ND	ND

PESTICIDE/PCBs

	UG/KG	1-N-SB36-06	1-N-SB37-02	1-GW07-03	1-GW08-03	1-GW09-03	1-GW11-01	1-GW12-02	1-GW16-04	1-GW16-06
alpha-BHC	UG/KG	ND	ND	ND	ND	ND	ND	ND	ND	ND
beta-BHC	UG/KG	ND	ND	ND	ND	ND	ND	ND	ND	ND
delta-BHC	UG/KG	ND	ND	ND	ND	ND	ND	ND	ND	ND
Lindane (gamma-BHC)	UG/KG	ND	ND	ND	ND	ND	ND	ND	ND	ND
Heptachlor	UG/KG	ND	ND	ND	ND	ND	ND	ND	ND	ND
Aldrin	UG/KG	ND	ND	ND	ND	ND	ND	ND	ND	ND
Heptachlor epoxide	UG/KG	ND	ND	ND	ND	ND	ND	ND	ND	ND
Endosulfan I	UG/KG	ND	ND	ND	ND	ND	ND	ND	ND	ND
Dieldrin	UG/KG	ND	ND	ND	ND	ND	ND	ND	ND	ND
4,4'-DDE	UG/KG	ND	ND	ND	ND	ND	ND	ND	ND	ND

UG/KG - micrograms per kilogram

J - estimated

ND - not detected

NJ - tentatively identified

R - rejected

TABLE 5-5
SUBSURFACE SOIL - POSITIVE DETECTION SUMMARY
SITE 1, FRENCH CREEK LIQUIDS DISPOSAL AREA
REMEDIAL INVESTIGATION CTO-0231
MCB, CAMP LEJEUNE, NORTH CAROLINA
TCL ORGANICS

Sample ID:	1-N-SB36-06	1-N-SB37-02	1-GW07-03	1-GW08-03	1-GW09-03	1-GW11-01	1-GW12-02	1-GW16-04	1-GW16-06
Sample Depth:	11-13'	3-5'	5-7'	5-7'	5-7'	1-3'	3-5'	7-9'	11-13'
Date Sampled:	3/29/94	3/29/94	4/12/94	4/12/94	4/10/94	4/10/94	4/10/94	4/13/94	4/13/94

UNITS

PESTICIDE/PCBs Cont.

	UG/KG	1-N-SB36-06	1-N-SB37-02	1-GW07-03	1-GW08-03	1-GW09-03	1-GW11-01	1-GW12-02	1-GW16-04	1-GW16-06
Endrin	UG/KG	ND	ND	ND	ND	ND	ND	ND	ND	ND
Endosulfan II	UG/KG	ND	ND	ND	ND	ND	ND	ND	ND	ND
4,4'-DDD	UG/KG	ND	ND	ND	ND	ND	ND	ND	ND	ND
Endosulfan sulfate	UG/KG	ND	ND	ND	ND	ND	ND	ND	ND	ND
4,4'-DDT	UG/KG	ND	5.5 J	ND	ND	ND	ND	ND	ND	ND
Methoxychlor	UG/KG	ND	ND	ND	ND	ND	ND	ND	ND	ND
Endrin ketone	UG/KG	ND	ND	ND	ND	ND	ND	ND	ND	ND
Endrin aldehyde	UG/KG	ND	ND	ND	ND	ND	ND	ND	ND	ND
alpha-Chlordane	UG/KG	ND	9.2 NJ	ND	ND	ND	ND	ND	ND	ND
gamma-Chlordane	UG/KG	ND	2.5 NJ	ND	ND	ND	ND	ND	ND	ND
Toxaphene	UG/KG	ND	ND	ND	ND	ND	ND	ND	ND	ND
Aroclor 1016	UG/KG	ND	ND	ND	ND	ND	ND	ND	ND	ND
Aroclor 1221	UG/KG	ND	ND	ND	ND	ND	ND	ND	ND	ND
Aroclor 1232	UG/KG	ND	ND	ND	ND	ND	ND	ND	ND	ND
Aroclor 1242	UG/KG	ND	ND	ND	ND	ND	ND	ND	ND	ND
Aroclor 1248	UG/KG	ND	ND	ND	ND	ND	ND	ND	ND	ND
Aroclor 1254	UG/KG	ND	ND	ND	ND	ND	ND	ND	18 J	ND
Aroclor 1260	UG/KG	ND	ND	ND	ND	ND	ND	ND	ND	ND

UG/KG - micrograms per kilogram

J - estimated

ND - not detected

NJ - tentatively identified

R - rejected

TABLE 5-5
SUBSURFACE SOIL - POSITIVE DETECTION SUMMARY
SITE 1, FRENCH CREEK LIQUIDS DISPOSAL AREA
REMEDIAL INVESTIGATION CTO-0231
MCB, CAMP LEJEUNE, NORTH CAROLINA
TCL ORGANICS

Sample ID:	1-GW16DW-04	1-GW16DW-07	1-GW17-05	1-GW17DW-05
Sample Depth:	7-9'	13-15'	9-11'	9-11'
Date Sampled:	5/2/94	5/2/94	4/19/94	5/5/94

UNITS

VOLATILES

	UG/KG	1-GW16DW-04	1-GW16DW-07	1-GW17-05	1-GW17DW-05
Methylene chloride	UG/KG	ND	ND	ND	ND
Acetone	UG/KG	ND	ND	ND	36
Trichloroethene	UG/KG	ND	ND	ND	ND
1,1,2,2-Tetrachloroethane	UG/KG	ND	ND	ND	ND
Toluene	UG/KG	ND	ND	ND	1 J
Xylenes (total)	UG/KG	ND	ND	ND	ND

SEMIVOLATILES

	UG/KG	1-GW16DW-04	1-GW16DW-07	1-GW17-05	1-GW17DW-05
Phenol	UG/KG	ND	ND	ND	ND
bis(2-Chloroethyl) ether	UG/KG	ND	ND	ND	ND
2-Chlorophenol	UG/KG	ND	ND	ND	ND
1,3-Dichlorobenzene	UG/KG	ND	ND	ND	ND
1,4-Dichlorobenzene	UG/KG	ND	ND	ND	ND
1,2-Dichlorobenzene	UG/KG	ND	ND	ND	ND
2-Methylphenol	UG/KG	ND	ND	ND	ND
2,2'-oxybis-(1-chloropropane)	UG/KG	ND	ND	ND	ND
4-Methylphenol	UG/KG	ND	ND	ND	ND
N-Nitroso-di-n-propylamine	UG/KG	ND	ND	ND	ND
Hexachloroethane	UG/KG	ND	ND	ND	ND
Nitrobenzene	UG/KG	ND	ND	ND	ND
Isophorone	UG/KG	ND	ND	ND	ND
2-Nitrophenol	UG/KG	ND	ND	ND	ND
2,4-Dimethylphenol	UG/KG	ND	ND	ND	ND
bis(2-Chloroethoxy) methane	UG/KG	ND	ND	ND	ND
2,4-Dichlorophenol	UG/KG	ND	ND	ND	ND
1,2,4-Trichlorobenzene	UG/KG	ND	ND	ND	ND
Naphthalene	UG/KG	ND	ND	ND	ND
4-Chloroaniline	UG/KG	ND	ND	ND	ND

UG/KG - micrograms per kilogram

J - estimated

ND - not detected

NJ - tentatively identified

R - rejected

TABLE 5-5
SUBSURFACE SOIL - POSITIVE DETECTION SUMMARY
SITE 1, FRENCH CREEK LIQUIDS DISPOSAL AREA
REMEDIAL INVESTIGATION CTO-0231
MCB, CAMP LEJEUNE, NORTH CAROLINA
TCL ORGANICS

Sample ID:	1-GW16DW-04	1-GW16DW-07	1-GW17-05	1-GW17DW-05
Sample Depth:	7-9'	13-15'	9-11'	9-11'
Date Sampled:	5/2/94	5/2/94	4/19/94	5/5/94

UNITS

SEMIVOLATILES Cont.

Hexachlorobutadiene	UG/KG	ND	ND	ND
4-Chloro-3-methylphenol	UG/KG	ND	ND	ND
2-Methylnaphthalene	UG/KG	ND	ND	ND
Hexachlorocyclopentadiene	UG/KG	ND	ND	ND
2,4,6-Trichlorophenol	UG/KG	ND	ND	ND
2,4,5-Trichlorophenol	UG/KG	ND	ND	ND
2-Chloronaphthalene	UG/KG	ND	ND	ND
2-Nitroaniline	UG/KG	ND	ND	ND
Dimethyl phthalate	UG/KG	ND	ND	ND
Acenaphthylene	UG/KG	ND	ND	ND
2,6-Dinitrotoluene	UG/KG	ND	ND	ND
3-Nitroaniline	UG/KG	ND	ND	ND
Acenaphthene	UG/KG	ND	ND	ND
2,4-Dinitrophenol	UG/KG	ND	ND	ND
4-Nitrophenol	UG/KG	ND	ND	ND
Dibenzofuran	UG/KG	ND	ND	ND
2,4-Dinitrotoluene	UG/KG	ND	ND	ND
Diethylphthalate	UG/KG	ND	ND	ND
4-Chlorophenyl phenyl ether	UG/KG	ND	ND	ND
Fluorene	UG/KG	ND	ND	ND
4-Nitroaniline	UG/KG	ND	ND	ND
4,6-Dinitro-2-methylphenol	UG/KG	ND	ND	ND
N-nitrosodiphenylamine	UG/KG	ND	ND	ND
4-Bromophenyl-phenylether	UG/KG	ND	ND	ND
Hexachlorobenzene	UG/KG	ND	ND	ND
Pentachlorophenol	UG/KG	ND	ND	ND
Phenanthrene	UG/KG	ND	ND	ND
Anthracene	UG/KG	ND	ND	ND

UG/KG - micrograms per kilogram

J - estimated

ND - not detected

NJ - tentatively identified

R - rejected

TABLE 5-5
SUBSURFACE SOIL - POSITIVE DETECTION SUMMARY
SITE 1, FRENCH CREEK LIQUIDS DISPOSAL AREA
REMEDIAL INVESTIGATION CTO-0231
MCB, CAMP LEJEUNE, NORTH CAROLINA
TCL ORGANICS

Sample ID:	1-GW16DW-04	1-GW16DW-07	1-GW17-05	1-GW17DW-05
Sample Depth:	7-9'	13-15'	9-11'	9-11'
Date Sampled:	5/2/94	5/2/94	4/19/94	5/5/94

UNITS

SEMIVOLATILES Cont.

	UG/KG	1-GW16DW-04	1-GW16DW-07	1-GW17-05	1-GW17DW-05
Carbazole	UG/KG	ND	ND	ND	ND
di-n-Dutylphthalate	UG/KG	ND	ND	ND	ND
Fluoranthene	UG/KG	ND	ND	ND	ND
Pyrene	UG/KG	ND	ND	ND	ND
Butyl benzyl phthalate	UG/KG	ND	ND	ND	ND
3,3'-Dichlorobenzidine	UG/KG	ND	ND	ND	ND
Benzo[a]anthracene	UG/KG	ND	ND	ND	ND
Chrysene	UG/KG	ND	ND	ND	ND
bis(2-Ethylhexyl)phthalate	UG/KG	720	170 J	49 J	ND
di-n-Octylphthalate	UG/KG	ND	ND	ND	ND
Benzo[b]fluoranthene	UG/KG	ND	ND	ND	ND
Benzo[k]fluoranthene	UG/KG	ND	ND	ND	ND
Benzo[a]pyrene	UG/KG	ND	ND	ND	ND
Indeno[1,2,3-cd]pyrene	UG/KG	ND	ND	ND	ND
Dibenz[a,h]anthracene	UG/KG	ND	ND	ND	ND
Benzo[g,h,i]perylene	UG/KG	ND	ND	ND	ND

PESTICIDE/PCBs

	UG/KG	1-GW16DW-04	1-GW16DW-07	1-GW17-05	1-GW17DW-05
alpha-BHC	UG/KG	ND	ND	ND	ND
beta-BHC	UG/KG	ND	ND	ND	ND
delta-BHC	UG/KG	ND	ND	ND	ND
Lindane (gamma-BHC)	UG/KG	ND	ND	ND	ND
Heptachlor	UG/KG	ND	ND	ND	ND
Aldrin	UG/KG	ND	ND	ND	ND
Heptachlor epoxide	UG/KG	ND	ND	ND	ND
Endosulfan I	UG/KG	ND	ND	ND	ND
Dieldrin	UG/KG	ND	ND	7.1 J	ND
4,4'-DDE	UG/KG	ND	ND	11.0	ND

UG/KG - micrograms per kilogram

J - estimated

ND - not detected

NJ - tentatively identified

R - rejected

TABLE 5-5
 SUBSURFACE SOIL - POSITIVE DETECTION SUMMARY
 SITE 1, FRENCH CREEK LIQUIDS DISPOSAL AREA
 REMEDIAL INVESTIGATION CTO-0231
 MCB, CAMP LEJEUNE, NORTH CAROLINA
 TCL ORGANICS

Sample ID:	1-GW16DW-04	1-GW16DW-07	1-GW17-05	1-GW17DW-05
Sample Depth:	7-9'	13-15'	9-11'	9-11'
Date Sampled:	5/2/94	5/2/94	4/19/94	5/5/94

UNITS

PESTICIDE/PCBs Cont.

Endrin	UG/KG	ND	ND	ND	ND
Endosulfan II	UG/KG	ND	ND	ND	ND
4,4'-DDD	UG/KG	ND	ND	ND	ND
Endosulfan sulfate	UG/KG	ND	ND	ND	ND
4,4'-DDT	UG/KG	ND	ND	7.8	ND
Methoxychlor	UG/KG	ND	ND	ND	ND
Endrin ketone	UG/KG	ND	ND	ND	ND
Endrin aldehyde	UG/KG	ND	ND	ND	ND
alpha-Chlordane	UG/KG	ND	ND	ND	ND
gamma-Chlordane	UG/KG	ND	ND	ND	ND
Toxaphene	UG/KG	ND	ND	ND	ND
Aroclor 1016	UG/KG	ND	ND	ND	ND
Aroclor 1221	UG/KG	ND	ND	ND	ND
Aroclor 1232	UG/KG	ND	ND	ND	ND
Aroclor 1242	UG/KG	ND	ND	ND	ND
Aroclor 1248	UG/KG	ND	ND	ND	ND
Aroclor 1254	UG/KG	ND	ND	ND	ND
Aroclor 1260	UG/KG	ND	ND	ND	ND

UG/KG - micrograms per kilogram

J - estimated

ND - not detected

NJ - tentatively identified

R - rejected

TABLE 5-6
SUBSURFACE SOIL - POSITIVE DETECTION SUMMARY
SITE 1, FRENCH CREEK LIQUIDS DISPOSAL AREA
REMEDIAL INVESTIGATION CTO-0231
MCB, CAMP LEJEUNE, NORTH CAROLINA
TOTAL METALS

	Sample ID:	1-S-SB01-01	1-S-SB01-04	1-S-SB01-08	1-S-SB02-01	1-S-SB02-04	1-S-SB02-07	1-S-SB03-01
	Sample Depth:	1-3'	7-9'	15-17'	1-3'	7-9'	13-15'	1-3'
	Date Sampled:	3/29/94	3/29/94	3/29/94	4/6/94	4/6/94	4/6/94	3/30/94
	<u>UNITS</u>							
Aluminum	MG/KG	6840	4270	3600	1360	4160	2410	10100
Antimony	MG/KG	ND	ND	ND	ND	ND	ND	ND
Arsenic	MG/KG	1.7	4.8	1.4	ND	2.6 J	0.68 J	2.4
Barium	MG/KG	10.4	7.7	7.4	9.1	6.3	9.0	20.4
Cadmium	MG/KG	ND	ND	ND	ND	ND	ND	0.71
Calcium	MG/KG	321 J	110 J	ND	11000 J	12800 J	952 J	1160 J
Chromium	MG/KG	9.5	7.1 J	4.9 J	5.1 J	6.7 J	3.8 J	15.6
Cobalt	MG/KG	ND	ND	0.80	ND	ND	ND	ND
Copper	MG/KG	2.0	ND	1.7	1.7	ND	ND	ND
Iron	MG/KG	4600	3940	985	969	2940	638	6330
Lead	MG/KG	5.0	4.0 J	2.9 J	15.2 J	3.1 J	2.7 J	6.8
Magnesium	MG/KG	104	151	110	230	357	73.0	234
Manganese	MG/KG	4.4 J	1.9 J	1.6 J	11.0 J	17.8 J	6.0 J	5.6
Mercury	MG/KG	ND	0.23	0.34	ND	ND	ND	0.06
Nickel	MG/KG	ND	2.1	3.4	1.8 J	1.7 J	2.4 J	ND
Potassium	MG/KG	86.7 J	255 J	123 J	64.2 J	217 J	65.6 J	ND
Selenium	MG/KG	ND	ND	ND	ND	ND	ND	1.5 J
Silver	MG/KG	ND	ND	ND	ND	ND	ND	ND
Sodium	MG/KG	26.6	10.2	ND	ND	ND	ND	ND
Vanadium	MG/KG	12.2	12.6	5.0	3.2	10.0	2.6	18.4
Zinc	MG/KG	78.6 J	2.2 J	1.7 J	7.4 J	2.8 J	1.5 J	ND

MG/KG - milligrams per kilogram

J - estimated

ND - not detected

TABLE 5-6
SUBSURFACE SOIL - POSITIVE DETECTION SUMMARY
SITE 1, FRENCH CREEK LIQUIDS DISPOSAL AREA
REMEDIAL INVESTIGATION CTO-0231
MCB, CAMP LEJEUNE, NORTH CAROLINA
TOTAL METALS

	Sample ID:	1-S-SB03-03	1-S-SB03-06	1-S-SB04-01	1-S-SB04-04	1-S-SB04-06	1-S-SB05-01	1-S-SB05-04
	Sample Depth:	5-7'	11-13'	1-3'	7-9'	11-13'	1-3'	7-9'
	Date Sampled:	3/30/94	3/30/94	4/5/94	4/5/94	4/5/94	3/30/94	3/30/94
	<u>UNITS</u>							
Aluminum	MG/KG	4300	6320	5910	3060	1360	7550	1120
Antimony	MG/KG	ND	ND	ND	ND	ND	ND	ND
Arsenic	MG/KG	0.76	0.80	1.0 J	2.3 J	ND	1.5	ND
Barium	MG/KG	5.4	7.3	14.7	4.9	2.3	13.0	4.3
Cadmium	MG/KG	ND	ND	ND	ND	ND	ND	ND
Calcium	MG/KG	ND	ND	731 J	ND	ND	11700 J	540 J
Chromium	MG/KG	5.7 J	5.8 J	7.3 J	5.1 J	2.2	13.2	ND
Cobalt	MG/KG	ND	0.85	ND	ND	ND	ND	ND
Copper	MG/KG	ND	1.3	1.5	1.2	ND	ND	ND
Iron	MG/KG	1350	680	2720	2400	783	3870	254
Lead	MG/KG	3.0 J	4.6 J	5.1 J	2.9 J	2.4 J	7.1	2.1 J
Magnesium	MG/KG	197	161	191	147	ND	338	39.9
Manganese	MG/KG	3.4 J	2.6 J	8.8 J	2.9 J	ND	12.3	0.52 J
Mercury	MG/KG	ND	0.28	ND	ND	ND	ND	ND
Nickel	MG/KG	1.2	2.8	ND	ND	ND	ND	ND
Potassium	MG/KG	174 J	189 J	105 J	186 J	ND	ND	40.3 J
Selenium	MG/KG	ND	ND	ND	ND	ND	ND	ND
Silver	MG/KG	ND	ND	ND	ND	ND	ND	ND
Sodium	MG/KG	34.7	21.9	ND	ND	ND	ND	36.6
Vanadium	MG/KG	6.0	5.8	8.8	6.9	3.7	11.9	1.1
Zinc	MG/KG	3.0 J	2.3 J	2.7 J	1.6 J	ND	6.7 J	1.3 J

MG/KG - milligrams per kilogram
 J - estimated
 ND - not detected

TABLE 5-6
SUBSURFACE SOIL - POSITIVE DETECTION SUMMARY
SITE 1, FRENCH CREEK LIQUIDS DISPOSAL AREA
REMEDIAL INVESTIGATION CTO-0231
MCB, CAMP LEJEUNE, NORTH CAROLINA
TOTAL METALS

	Sample ID:	1-S-SB05-08	1-S-SB06-01	1-S-SB06-04	1-S-SB06-08	1-S-SB07-01	1-S-SB07-04	1-S-SB07-07
	Sample Depth:	15-17'	1-3'	7-9'	15-17'	1-3'	7-9'	13-15'
	Date Sampled:	3/30/94	4/5/94	4/5/94	4/5/94	3/30/94	3/30/94	3/30/94
	<u>UNITS</u>							
Aluminum	MG/KG	3440	13700	5630	2740	2470	4970	1200
Antimony	MG/KG	ND	ND	ND	ND	ND	ND	ND
Arsenic	MG/KG	1.0	2.6 J	2.7	ND	0.69	3.1	ND
Barium	MG/KG	5.5	16.4	8.7	5.8	7.9	6.7	2.5
Cadmium	MG/KG	ND	ND	ND	ND	ND	ND	ND
Calcium	MG/KG	ND	404 J	56.2 J	59.5 J	3250 J	230 J	ND
Chromium	MG/KG	5.6 J	16.9 J	9.4	2.2	4.8	7.2 J	1.6 J
Cobalt	MG/KG	0.82	ND	ND	ND	ND	ND	ND
Copper	MG/KG	1.3	2.6	1.4	ND	ND	ND	ND
Iron	MG/KG	1150	7600	3790	379	1400	3160	112
Lead	MG/KG	1.6 J	7.3 J	3.9	1.3	5.6	4.4 J	ND
Magnesium	MG/KG	73.7	372	227	82.5	101	267	11.3
Manganese	MG/KG	3.8 J	7.4 J	2.1 J	0.98 J	3.8 J	4.4 J	0.26 J
Mercury	MG/KG	ND	ND	ND	ND	ND	ND	0.19
Nickel	MG/KG	1.6	4.3 J	3.0	2.0	ND	1.6	ND
Potassium	MG/KG	115 J	230 J	293 J	113 J	ND	279 J	31.3 J
Selenium	MG/KG	ND	ND	ND	ND	ND	ND	ND
Silver	MG/KG	ND	ND	ND	ND	ND	ND	ND
Sodium	MG/KG	14.3	ND	ND	ND	ND	26.1	ND
Vanadium	MG/KG	3.9	22.8	15.3	2.0	3.9	9.8	0.58
Zinc	MG/KG	1.4 J	4.9 J	ND	ND	ND	2.1 J	0.63 J

MG/KG - milligrams per kilogram

J - estimated

ND - not detected

TABLE 5-6
 SUBSURFACE SOIL - POSITIVE DETECTION SUMMARY
 SITE 1, FRENCH CREEK LIQUIDS DISPOSAL AREA
 REMEDIAL INVESTIGATION CTO-0231
 MCB, CAMP LEJEUNE, NORTH CAROLINA
 TOTAL METALS

	Sample ID:	1-S-SB08-01	1-S-SB08-04	1-S-SB08-07	1-S-SB09-01	1-S-SB09-04	1-S-SB09-07	1-S-SB10-01
	Sample Depth:	1-3'	7-9'	13-15'	1-3'	7-9'	13-15'	1-3'
	Date Sampled:	4/5/94	4/5/94	4/5/94	4/5/94	4/5/94	4/5/94	3/29/94
	<u>UNITS</u>							
Aluminum	MG/KG	6710	7130	4190	2050	5550	2940	3240
Antimony	MG/KG	ND	ND	ND	ND	ND	ND	ND
Arsenic	MG/KG	1.0	3.9	ND	ND	1.2	ND	ND
Barium	MG/KG	16.9	11.0	5.1	9.5	6.7	2.6	8.0
Cadmium	MG/KG	ND	ND	ND	0.84	ND	ND	ND
Calcium	MG/KG	ND	ND	ND	30800	ND	ND	4040 J
Chromium	MG/KG	6.5	9.8	8.8	8.2	7.0	4.6	4.1
Cobalt	MG/KG	ND	ND	ND	ND	ND	ND	ND
Copper	MG/KG	ND	ND	ND	ND	ND	ND	ND
Iron	MG/KG	2990	4890	857	1690	2360	340	1630
Lead	MG/KG	4.7 J	5.1 J	3.9 J	15.2 J	4.2 J	2.9 J	3.4
Magnesium	MG/KG	208	322	68.0	526	313	41.3	127
Manganese	MG/KG	10.8	8.4	4.5	16.8	8.1	3.5	6.3
Mercury	MG/KG	ND	ND	ND	ND	ND	ND	ND
Nickel	MG/KG	ND	ND	ND	ND	ND	ND	ND
Potassium	MG/KG	ND	421 J	ND	ND	ND	ND	87.1 J
Selenium	MG/KG	ND	ND	ND	ND	ND	ND	ND
Silver	MG/KG	ND	ND	ND	ND	ND	ND	ND
Sodium	MG/KG	ND	ND	ND	ND	ND	ND	30.1
Vanadium	MG/KG	9.5	13.5	3.0	4.5	12.0	1.4	5.8
Zinc	MG/KG	1.5	2.1	1.2	8.7	1.6	0.66	7.4 J

MG/KG - milligrams per kilogram

J - estimated

ND - not detected

TABLE 5-6
SUBSURFACE SOIL - POSITIVE DETECTION SUMMARY
SITE 1, FRENCH CREEK LIQUIDS DISPOSAL AREA
REMEDIAL INVESTIGATION CTO-0231
MCB, CAMP LEJEUNE, NORTH CAROLINA
TOTAL METALS

	Sample ID:	1-S-SB10-04	1-S-SB10-08	1-S-SB11-01	1-S-SB11-03	1-S-SB11-06	1-S-SB12-01	1-S-SB12-04
	Sample Depth:	7-9'	15-17'	1-3'	5-7'	11-13'	1-3'	7-9'
	Date Sampled:	3/29/94	3/29/94	3/30/94	3/30/94	3/30/94	4/6/94	4/6/94
	<u>UNITS</u>							
Aluminum	MG/KG	1640	1800	2480	1450	1780	6460	5780
Antimony	MG/KG	ND	ND	6.1 J	ND	ND	ND	ND
Arsenic	MG/KG	0.70	ND	0.80	0.73	1.1	0.68	3.4
Barium	MG/KG	3.9	2.9	10.2	3.1	2.1	14.2	10.1
Cadmium	MG/KG	ND	ND	0.72	ND	ND	ND	ND
Calcium	MG/KG	ND	104 J	74400 J	269 J	ND	866	ND
Chromium	MG/KG	3.0 J	2.6 J	7.0	2.2 J	2.3 J	7.2	9.1
Cobalt	MG/KG	ND	ND	ND	ND	ND	ND	0.81
Copper	MG/KG	ND	ND	4.5	ND	2.4	ND	ND
Iron	MG/KG	808	312	1640	573	199	3080	4560
Lead	MG/KG	2.7 J	ND	7.8	3.3 J	1.9 J	4.9 J	4.8 J
Magnesium	MG/KG	35.2	48.9	1130	76.0	9.4	171	273
Manganese	MG/KG	4.1 J	1.4 J	61.3	1.6 J	1.5 J	15.1	5.4
Mercury	MG/KG	ND	ND	ND	ND	ND	ND	ND
Nickel	MG/KG	ND	ND	ND	ND	1.9 B	ND	ND
Potassium	MG/KG	53.0 J	75.8 J	204 J	55.3 J	20.3 J	ND	386 J
Selenium	MG/KG	ND	ND	ND	ND	ND	ND	ND
Silver	MG/KG	ND	ND	ND	ND	ND	1.0 J	ND
Sodium	MG/KG	24.5	26.9	ND	25.5	ND	ND	ND
Vanadium	MG/KG	2.9	1.6	9.1	1.9	1.4	8.9	11.1
Zinc	MG/KG	2.2 J	1.0 J	11.9 J	0.82 J	0.68 J	1.4	1.7

MG/KG - milligrams per kilogram

J - estimated

ND - not detected

TABLE 5-6
SUBSURFACE SOIL - POSITIVE DETECTION SUMMARY
SITE 1, FRENCH CREEK LIQUIDS DISPOSAL AREA
REMEDIAL INVESTIGATION CTO-0231
MCB, CAMP LEJEUNE, NORTH CAROLINA
TOTAL METALS

	Sample ID:	1-S-SB12-07	1-S-SB13-01	1-S-SB13-04	1-S-SB13-07	1-S-SB14-01	1-S-SB14-03	1-S-SB14-06
	Sample Depth:	13-15'	1-3'	7-9'	13-15'	1-3'	5-7'	11-13'
	Date Sampled:	4/6/94	4/6/94	4/6/94	4/6/94	4/6/94	4/6/94	4/6/94
	<u>UNITS</u>							
Aluminum	MG/KG	4730	5660	546	7470	1710	3240	3620
Antimony	MG/KG	ND	ND	7.8 J	ND	ND	ND	ND
Arsenic	MG/KG	ND	ND	ND	0.69	ND	ND	1.5
Barium	MG/KG	7.7	12.6	3.1	10.1	10.3	5.0	8.0
Cadmium	MG/KG	ND	ND	ND	1.1	ND	ND	ND
Calcium	MG/KG	ND	890	ND	ND	2810	5120	21500
Chromium	MG/KG	4.9	8.9	1.5	8.8	2.0	4.2	6.2
Cobalt	MG/KG	ND	ND	ND	ND	ND	ND	ND
Copper	MG/KG	ND	ND	ND	ND	ND	ND	ND
Iron	MG/KG	693	2260	517	1070	615	1320	2060
Lead	MG/KG	3.8 J	3.6 J	2.5 J	5.1 J	6.1 J	2.6 J	5.1 J
Magnesium	MG/KG	138	174	ND	251	87.1	195	504
Manganese	MG/KG	3.5	9.4	6.0	7.8	6.2	7.9	23.5
Mercury	MG/KG	ND	ND	ND	ND	ND	ND	ND
Nickel	MG/KG	ND	ND	ND	ND	ND	ND	ND
Potassium	MG/KG	ND	ND	ND	ND	ND	ND	ND
Selenium	MG/KG	ND	ND	ND	ND	ND	ND	ND
Silver	MG/KG	ND	ND	ND	ND	ND	ND	ND
Sodium	MG/KG	ND	ND	ND	ND	ND	ND	ND
Vanadium	MG/KG	3.7	7.2	2.6	6.9	2.5	4.8	8.3
Zinc	MG/KG	0.66	1.2	0.64	1.5	3.2	2.1	1.6

MG/KG - milligrams per kilogram

J - estimated

ND - not detected

TABLE 5-6
SUBSURFACE SOIL - POSITIVE DETECTION SUMMARY
SITE 1, FRENCH CREEK LIQUIDS DISPOSAL AREA
REMEDIAL INVESTIGATION CTO-0231
MCB, CAMP LEJEUNE, NORTH CAROLINA
TOTAL METALS

	Sample ID:	1-S-SB15-01	1-S-SB15-04	1-S-SB15-06	1-S-SB16-01	1-S-SB16-04	1-S-SB16-07	1-S-SB17-01
	Sample Depth:	1-3'	7-9'	11-13'	1-3'	7-9'	13-15'	1-3'
	Date Sampled:	4/5/94	4/5/94	4/5/94	4/5/94	4/5/94	4/5/94	3/30/94
	<u>UNITS</u>							
Aluminum	MG/KG	3550	3870	1050	13600	1240	2100	3540
Antimony	MG/KG	ND	ND	ND	ND	ND	ND	ND
Arsenic	MG/KG	ND	2.6	ND	2.3 J	ND	ND	1.4
Barium	MG/KG	8.8	6.0	3.2	16.4	3.3	3.1	8.7
Cadmium	MG/KG	ND	ND	ND	ND	ND	ND	ND
Calcium	MG/KG	500 J	49.5 J	16.3 J	614 J	ND	ND	37800 J
Chromium	MG/KG	4.4 J	6.0	2.8	15.7 J	2.1	1.8	6.9
Cobalt	MG/KG	ND	1.0	0.64	ND	ND	ND	ND
Copper	MG/KG	1.8	1.4	ND	2.6	ND	ND	ND
Iron	MG/KG	1850	2820	302	9320	279	320	2170
Lead	MG/KG	2.6 J	3.5	2.0	6.0 J	2.0	1.7	5.3
Magnesium	MG/KG	107	202	29.2	316	50.9	81.2	638
Manganese	MG/KG	5.9 J	2.4 J	7.2 J	7.4 J	1.0 J	ND	32.1
Mercury	MG/KG	ND	ND	ND	ND	ND	ND	ND
Nickel	MG/KG	2.3 J	2.9	1.8	3.5 J	ND	ND	2.6
Potassium	MG/KG	81.9 J	267 J	ND	219 J	102 J	93.5	ND
Selenium	MG/KG	ND	ND	ND	ND	ND	ND	ND
Silver	MG/KG	ND	ND	ND	ND	ND	ND	ND
Sodium	MG/KG	ND	ND	ND	ND	ND	ND	ND
Vanadium	MG/KG	5.4	9.3	1.7	26.1	1.7	1.9	8.6
Zinc	MG/KG	1.8 J	ND	ND	5.1 J	ND	ND	6.1 J

MG/KG - milligrams per kilogram

J - estimated

ND - not detected

TABLE 5-6
 SUBSURFACE SOIL - POSITIVE DETECTION SUMMARY
 SITE 1, FRENCH CREEK LIQUIDS DISPOSAL AREA
 REMEDIAL INVESTIGATION CTO-0231
 MCB, CAMP LEJEUNE, NORTH CAROLINA
 TOTAL METALS

	Sample ID:	1-S-SB17-03	1-S-SB17-06	1-S-SB18-01	1-S-SB18-04	1-S-SB18-07	1-N-SB19-04	1-N-SB20-05
	Sample Depth:	5-7'	11-13'	1-3'	7-9'	13-15'	7-9'	9-11'
	Date Sampled:	3/30/94	3/30/94	4/5/94	4/5/94	4/5/94	3/28/94	3/29/94
	<u>UNITS</u>							
Aluminum	MG/KG	3010	5480	3870	4420	2240	1870	11200
Antimony	MG/KG	ND	ND	ND	ND	ND	ND	ND
Arsenic	MG/KG	2.8	ND	ND	ND	ND	0.67	ND
Barium	MG/KG	4.8	11.8	10.9	6.6	2.7	5.4	18.1
Cadmium	MG/KG	ND	ND	ND	ND	ND	ND	ND
Calcium	MG/KG	488 J	48.1 J	2350	915	74.5	405 J	226 J
Chromium	MG/KG	7.1	5.0	4.5	4.8	3.3	1.7 J	9.9 J
Cobalt	MG/KG	ND	ND	ND	ND	ND	ND	ND
Copper	MG/KG	ND	1.2	3.0	ND	3.2	ND	1.7
Iron	MG/KG	2760	503	3490	1710	179	834	1490
Lead	MG/KG	2.9	3.8	3.8 J	4.0 J	ND	ND	5.9 J
Magnesium	MG/KG	140	112	160	199	22.0	48.2 J	292
Manganese	MG/KG	0.60 J	0.35 J	25.0	7.3	1.3	10.0	6.7 J
Mercury	MG/KG	ND	ND	ND	ND	ND	ND	ND
Nickel	MG/KG	ND	3.4	4.3 J	1.7 J	ND	ND	3.7
Potassium	MG/KG	ND	125 J	142 J	231 J	77.8 J	29.1 J	309 J
Selenium	MG/KG	ND	ND	ND	ND	ND	ND	ND
Silver	MG/KG	ND	ND	ND	ND	ND	ND	ND
Sodium	MG/KG	ND	ND	ND	ND	ND	26.4	ND
Vanadium	MG/KG	8.4	3.1	6.0	6.5	0.94	2.8	7.7
Zinc	MG/KG	ND	ND	63.7	1.3	37.6	1.3 J	ND

MG/KG - milligrams per kilogram
 J - estimated
 ND - not detected

TABLE 5-6
SUBSURFACE SOIL - POSITIVE DETECTION SUMMARY
SITE 1, FRENCH CREEK LIQUIDS DISPOSAL AREA
REMEDIAL INVESTIGATION CTO-0231
MCB, CAMP LEJEUNE, NORTH CAROLINA
TOTAL METALS

	Sample ID:	1-N-SB21-01	1-N-SB21-04	1-N-SB21-07	1-N-SB22-01	1-N-SB22-06	1-N-SB22-08	1-N-SB23-01
	Sample Depth:	1-3'	7-9'	13-15'	1-3'	11-13'	15-17'	1-3'
	Date Sampled:	3/29/94	3/29/94	3/29/94	4/5/94	4/5/94	4/5/94	4/5/94
	<u>UNITS</u>							
Aluminum	MG/KG	1880	6810	4700	4980	2180	508	1710
Antimony	MG/KG	ND	ND	ND	ND	ND	ND	ND
Arsenic	MG/KG	ND	ND	3.4	0.73 J	ND	0.68	ND
Barium	MG/KG	2.5	14.0	8.2	8.2	3.5	2.4	3.3
Cadmium	MG/KG	ND	ND	ND	ND	ND	ND	ND
Calcium	MG/KG	832 J	303 J	174 J	1200 J	226 J	124 J	1000 J
Chromium	MG/KG	2.7 J	6.2 J	5.7 J	5.8 J	3.7	2.9	1.9 J
Cobalt	MG/KG	ND	ND	ND	ND	ND	ND	ND
Copper	MG/KG	ND	1.6	ND	1.6	ND	ND	ND
Iron	MG/KG	850	1290	2440	2870	484	706	1080
Lead	MG/KG	2.8 J	4.6 J	4.8 J	5.4 J	2.2	ND	1.6 J
Magnesium	MG/KG	59.2	123	98.2	130	67.6	17.3	70.0
Manganese	MG/KG	1.7 J	3.5 J	2.5 J	5.5 J	2.6 J	0.84 J	5.8 J
Mercury	MG/KG	ND	ND	ND	ND	ND	ND	ND
Nickel	MG/KG	ND	1.8	ND	1.9 J	ND	ND	1.5 J
Potassium	MG/KG	46.0 J	150 J	183 J	136 J	101 J	46.4 J	52.9 J
Selenium	MG/KG	ND	ND	ND	ND	ND	ND	ND
Silver	MG/KG	ND	ND	ND	ND	ND	ND	ND
Sodium	MG/KG	ND	ND	ND	ND	12.4	26.5	ND
Vanadium	MG/KG	3.8	5.8	8.2	8.7	5.1	9.4	3.4
Zinc	MG/KG	ND	ND	ND	3.2 J	1.1 J	ND	2.9 J

MG/KG - milligrams per kilogram
 J - estimated
 ND - not detected

TABLE 5-6
 SUBSURFACE SOIL - POSITIVE DETECTION SUMMARY
 SITE 1, FRENCH CREEK LIQUIDS DISPOSAL AREA
 REMEDIAL INVESTIGATION CTO-0231
 MCB, CAMP LEJEUNE, NORTH CAROLINA
 TOTAL METALS

	Sample ID:	1-N-SB23-05	1-N-SB23-08	1-N-SB24-01	1-N-SB24-04	1-N-SB24-07	1-N-SB25-01	1-N-SB25-06
	Sample Depth:	9-11'	15-17'	1-3'	7-9'	13-15'	1-3'	11-13'
	Date Sampled:	4/5/94	4/5/94	3/29/94	3/29/94	3/29/94	3/29/94	3/29/94
	<u>UNITS</u>							
Aluminum	MG/KG	6970	1420	2850	6290	5620	2890	5030
Antimony	MG/KG	ND	ND	ND	ND	ND	ND	ND
Arsenic	MG/KG	ND	ND	ND	ND	ND	0.62	0.73
Barium	MG/KG	9.7	2.7	4.4	13.2	6.7	8.1	7.0
Cadmium	MG/KG	ND	ND	ND	ND	ND	ND	ND
Calcium	MG/KG	369 J	ND	2290 J	221 J	139 J	44200 J	537 J
Chromium	MG/KG	9.1 J	2.9 J	3.2 J	4.2 J	5.5 J	5.8 J	6.4 J
Cobalt	MG/KG	ND	ND	ND	ND	ND	ND	ND
Copper	MG/KG	1.1	ND	ND	ND	ND	1.7	1.3
Iron	MG/KG	1490	320	599	1040	1100	1510	1010
Lead	MG/KG	5.0 J	ND	3.4 J	3.5 J	3.9 J	10.9 J	3.6 J
Magnesium	MG/KG	193	28.9	120	137	186	829	162 J
Manganese	MG/KG	3.8 J	3.3 J	2.9 J	6.4 J	4.1 J	10.6 J	4.2 J
Mercury	MG/KG	ND	ND	ND	ND	ND	ND	ND
Nickel	MG/KG	ND	ND	ND	ND	1.8	ND	ND
Potassium	MG/KG	304 J	62.2 J	81.3 J	142 J	286 J	143 J	336 J
Selenium	MG/KG	ND	ND	ND	ND	ND	ND	ND
Silver	MG/KG	ND	ND	ND	ND	ND	ND	ND
Sodium	MG/KG	ND	25.0	ND	ND	ND	ND	18.6
Vanadium	MG/KG	9.3	2.6	3.9	4.5	6.6	5.6	8.1
Zinc	MG/KG	4.2 J	0.97 J	ND	ND	ND	14.5 J	3.1 J

MG/KG - milligrams per kilogram
 J - estimated
 ND - not detected

TABLE 5-6
SUBSURFACE SOIL - POSITIVE DETECTION SUMMARY
SITE 1, FRENCH CREEK LIQUIDS DISPOSAL AREA
REMEDIAL INVESTIGATION CTO-0231
MCB, CAMP LEJEUNE, NORTH CAROLINA
TOTAL METALS

	Sample ID:	1-N-SB26-01	1-N-SB26-04	1-N-SB27-01	1-N-SB27-05	1-N-SB28-01	1-N-SB28-04	1-N-SB29-02
	Sample Depth:	1-3'	7-9'	1-3'	9-11'	1-3'	7-9'	3-5'
	Date Sampled:	3/29/94	3/29/94	3/29/94	3/29/94	3/29/94	3/29/94	3/28/94
	<u>UNITS</u>							
Aluminum	MG/KG	3310	6480	1440	3080	1190	5330	2020
Antimony	MG/KG	ND	ND	ND	ND	ND	ND	ND
Arsenic	MG/KG	ND	0.65	0.95	0.82	ND	ND	0.66
Barium	MG/KG	13.2	13.7	21.3	11.0	4.0	8.4	6.7
Cadmium	MG/KG	ND	ND	ND	ND	ND	ND	ND
Calcium	MG/KG	36400 J	298 J	81300 J	60900 J	36500 J	1300 J	57000 J
Chromium	MG/KG	9.7 J	6.7 J	7.5 J	7.9 J	3.5 J	6.6 J	6.4 J
Cobalt	MG/KG	ND	ND	ND	ND	ND	ND	0.89
Copper	MG/KG	5.0	1.4	ND	1.3	ND	1.1	3.8
Iron	MG/KG	1740	1850	1210	1250	978	1110	1210
Lead	MG/KG	60.4 J	3.9 J	ND	2.1 J	10.5 J	4.0 J	14.6 J
Magnesium	MG/KG	633	183	1160	1050	556	192	908
Manganese	MG/KG	17.1 J	5.3 J	12.7 J	9.2 J	9.8 J	3.9 J	10.8 J
Mercury	MG/KG	ND	ND	ND	0.24	ND	ND	ND
Nickel	MG/KG	1.3	ND	ND	2.5	ND	3.0	ND
Potassium	MG/KG	131 J	250 J	154 J	228 J	67.2 J	371 J	105 J
Selenium	MG/KG	ND	ND	ND	ND	ND	ND	ND
Silver	MG/KG	ND	ND	ND	ND	ND	ND	ND
Sodium	MG/KG	ND	ND	161	92.8	ND	ND	153
Vanadium	MG/KG	5.1	10.2	6.8	8.9	3.2	8.8	4.7
Zinc	MG/KG	40.9 J	ND	ND	3.9 J	ND	ND	33.3 J

MG/KG - milligrams per kilogram
J - estimated
ND - not detected

TABLE 5-6
 SUBSURFACE SOIL - POSITIVE DETECTION SUMMARY
 SITE 1, FRENCH CREEK LIQUIDS DISPOSAL AREA
 REMEDIAL INVESTIGATION CTO-0231
 MCB, CAMP LEJEUNE, NORTH CAROLINA
 TOTAL METALS

	Sample ID:	1-N-SB30-03	1-N-SB31-01	1-N-SB31-04	1-N-SB32-01	1-N-SB32-04	1-N-SB32-07	1-N-SB33-01
	Sample Depth:	5-7'	1-3'	7-9'	1-3'	7-9'	13-15'	1-3'
	Date Sampled:	3/29/94	3/29/94	3/29/94	4/5/94	4/5/94	4/5/94	4/18/94
	<u>UNITS</u>							
Aluminum	MG/KG	6260	807	3880	2260	7730	2350	2120
Antimony	MG/KG	ND	ND	ND	ND	ND	ND	ND
Arsenic	MG/KG	3.1	ND	ND	ND	ND	ND	0.74
Barium	MG/KG	10.3	17.3	5.8	4.1	10.1	4.2	12.4
Cadmium	MG/KG	ND	ND	ND	ND	ND	ND	ND
Calcium	MG/KG	252 J	25500 J	398 J	669 J	6450 J	98.0 J	53700 J
Chromium	MG/KG	13.6 J	10.0 J	5.5 J	2.6 J	14.7	3.9	6.6
Cobalt	MG/KG	1.3	ND	ND	ND	1.1	ND	ND
Copper	MG/KG	2.3	ND	ND	ND	2.2	ND	2.1
Iron	MG/KG	5830	721	1160	871	1590	498	1500
Lead	MG/KG	6.2 J	ND	3.1 J	ND	4.3	2.9	16.4
Magnesium	MG/KG	170	386	137	44.2	261	87.5	829
Manganese	MG/KG	2.0 J	6.4 J	3.3 J	4.1 J	3.2 J	1.8 J	14.2
Mercury	MG/KG	ND	ND	ND	ND	ND	ND	ND
Nickel	MG/KG	ND	ND	ND	1.5 J	4.4	2.1	1.2
Potassium	MG/KG	215 J	92.8 J	244 J	94.4 J	437 J	233 J	117 J
Selenium	MG/KG	ND	ND	ND	ND	ND	ND	ND
Silver	MG/KG	ND	ND	ND	ND	ND	ND	ND
Sodium	MG/KG	14.3	ND	28.2	ND	ND	ND	ND
Vanadium	MG/KG	20.6	4.9	8.1	3.0	12.7	4.8	3.9
Zinc	MG/KG	1.3 J	ND	2.7 J	1.4 J	ND	ND	8.8

MG/KG - milligrams per kilogram
 J - estimated
 ND - not detected

TABLE 5-6
SUBSURFACE SOIL - POSITIVE DETECTION SUMMARY
SITE 1, FRENCH CREEK LIQUIDS DISPOSAL AREA
REMEDIAL INVESTIGATION CTO-0231
MCB, CAMP LEJEUNE, NORTH CAROLINA
TOTAL METALS

	Sample ID:	1-N-SB33-04	1-N-SB33-07	1-N-SB34-01	1-N-SB34-03	1-N-SB34-07	1-N-SB35-01	1-N-SB35-06
	Sample Depth:	7-9'	13-15'	1-3'	5-7'	13-15'	1-3'	11-13'
	Date Sampled:	4/18/94	4/18/94	3/29/94	3/29/94	3/29/94	3/29/94	3/29/94
	<u>UNITS</u>							
Aluminum	MG/KG	8260	4470	2420	3730	5110	1370	1900
Antimony	MG/KG	ND	7.0	ND	ND	ND	ND	ND
Arsenic	MG/KG	ND	5.6	0.79	0.88	0.60	ND	ND
Barium	MG/KG	9.3	11.7	6.1	10.1	5.1	15.4	3.7
Cadmium	MG/KG	ND	ND	ND	ND	ND	ND	ND
Calcium	MG/KG	323 J	603	61700 J	2160 J	160 J	38200 J	132 J
Chromium	MG/KG	9.3	9.3	7.6 J	5.9 J	2.4 J	5.0 J	2.9 J
Cobalt	MG/KG	ND	0.80	ND	ND	ND	ND	ND
Copper	MG/KG	2.0	1.6	ND	1.4	ND	2.3	ND
Iron	MG/KG	1480	5960	1880	2530	680	783	438
Lead	MG/KG	4.4	4.5	10.1 J	7.7 J	4.7 J	11.6 J	3.4 J
Magnesium	MG/KG	210	257	998	170	117	609	49.6
Manganese	MG/KG	3.6	4.5	14.7 J	6.5 J	3.5 J	8.3 J	2.1 J
Mercury	MG/KG	ND	ND	ND	ND	ND	ND	ND
Nickel	MG/KG	2.7	1.8	ND	ND	ND	ND	ND
Potassium	MG/KG	315 J	237 J	125 J	144 J	233 J	76.4 J	128 J
Selenium	MG/KG	ND	ND	ND	ND	ND	ND	ND
Silver	MG/KG	ND	ND	ND	ND	ND	ND	ND
Sodium	MG/KG	ND	24.2	138	ND	ND	ND	ND
Vanadium	MG/KG	9.8	14.0	5.4	8.3	5.1	3.9	4.6
Zinc	MG/KG	3.3	2.8	10.3 J	9.8 J	ND	25.1 J	ND

MG/KG - milligrams per kilogram

J - estimated

ND - not detected

TABLE 5-6
SUBSURFACE SOIL - POSITIVE DETECTION SUMMARY
SITE 1, FRENCH CREEK LIQUIDS DISPOSAL AREA
REMEDIAL INVESTIGATION CTO-0231
MCB, CAMP LEJEUNE, NORTH CAROLINA
TOTAL METALS

	Sample ID:	1-N-SB36-01	1-N-SB36-06	1-N-SB37-01	1-N-SB37-02	1-GW07-03	1-GW07-06	1-GW08-03	1-GW08-06
	Sample Depth:	1-3'	11-13'	1-3'	3-5'	5-7'	11-13'	5-7'	11-13'
	Date Sampled:	3/29/94	3/29/94	3/29/94	3/29/94	4/12/94	4/12/94	4/12/94	4/12/94
	<u>UNITS</u>								
Aluminum	MG/KG	2530	5150	1970	1890	5640	1620	3610	3300
Antimony	MG/KG	ND	ND	ND	ND	ND	ND	ND	ND
Arsenic	MG/KG	ND	ND	ND	ND	1.4	1.0	2.4	1.6
Barium	MG/KG	5.9	5.8	17.8	5.1	9.4	3.7	6.30	5.9
Cadmium	MG/KG	ND	ND	ND	ND	ND	ND	ND	ND
Calcium	MG/KG	12900 J	304 J	9300 J	26300 J	77.9	ND	525	592
Chromium	MG/KG	4.3	6.7 J	3.5 J	3.6 J	8.5	4.5	7.30	6.7
Cobalt	MG/KG	ND	1.1	ND	ND	ND	ND	ND	ND
Copper	MG/KG	ND	ND	1.8	ND	ND	ND	ND	1.6
Iron	MG/KG	1300	1090	1070	1120	2240	773	4750	3190
Lead	MG/KG	4.3	3.3 J	2.9 J	8.6 J	4.1	3.1	4	4.4
Magnesium	MG/KG	223	122	176	463	232	55.1	163	195
Manganese	MG/KG	3.3 J	2.3 J	6.4 J	8.2 J	6.9	3.7	2.2	4.4
Mercury	MG/KG	ND	ND	ND	ND	0.08	ND	ND	ND
Nickel	MG/KG	ND	ND	ND	ND	ND	ND	ND	ND
Potassium	MG/KG	ND	240 J	57.8 J	81.8 J	237 J	84.0 J	219 J	238 J
Selenium	MG/KG	ND	ND	ND	ND	ND	ND	ND	ND
Silver	MG/KG	ND	ND	ND	ND	ND	ND	ND	ND
Sodium	MG/KG	ND	35.4	ND	ND	ND	ND	ND	ND
Vanadium	MG/KG	4.2	8.2	4.1	3.7	8.5	3.3	10.5	8.8
Zinc	MG/KG	ND	2.0 J	ND	10.6 J	3.7	ND	6.4	6.9

MG/KG - milligrams per kilogram

J - estimated

ND - not detected

TABLE 5-6
SUBSURFACE SOIL - POSITIVE DETECTION SUMMARY
SITE 1, FRENCH CREEK LIQUIDS DISPOSAL AREA
REMEDIAL INVESTIGATION CTO-0231
MCB, CAMP LEJEUNE, NORTH CAROLINA
TOTAL METALS

Sample ID:	1-GW09-03	1-GW10-03	1-GW10-06	1-GW11-01	1-GW12-02	1-GW16-04	1-GW16-06	1-GW16DW-04
Sample Depth:	5-7'	5-7'	11-13'	1-3'	3-5'	7-9'	11-13'	7-9'
Date Sampled:	4/10/94	4/11/94	4/11/94	4/10/94	4/10/94	4/13/94	4/13/94	5/2/94

	<u>UNITS</u>								
Aluminum	MG/KG	5630	8220	8530	3480	7420	2160	1080	6490
Antimony	MG/KG	7.0	ND	7.6	ND	ND	ND	ND	7.0
Arsenic	MG/KG	0.86	2.0	5.0	0.83	ND	2.30	ND	5.60
Barium	MG/KG	12.2	16.2	8.3	5.2	9.7	3.9	2.1	11.7
Cadmium	MG/KG	ND	ND	ND	ND	ND	ND	ND	ND
Calcium	MG/KG	107	233	84.4	55.2	ND	34.1	ND	603.0
Chromium	MG/KG	7.4	10.2	17.5	6.8	11.8	4.0	2.4	9.3
Cobalt	MG/KG	ND	ND	ND	ND	ND	ND	ND	0.80
Copper	MG/KG	1.5	1.4	2.9	ND	ND	ND	ND	1.6
Iron	MG/KG	3140	2660	9000	2650	1910	2630	820	5960
Lead	MG/KG	4.0	4.7	5.1	3.2	4.6	2.6	2.2	4.5
Magnesium	MG/KG	219	228	304	114	216	97.2	38.6	257.0
Manganese	MG/KG	4.1	3.7	4.3	1.7 J	3.5 J	1.2	2.1	4.5
Mercury	MG/KG	ND	ND	ND	ND	ND	ND	ND	ND
Nickel	MG/KG	ND	ND	ND	ND	ND	1.2	ND	1.8
Potassium	MG/KG	132 J	200 J	436 J	168 J	289 J	143 J	52.9 J	237.0 J
Selenium	MG/KG	ND	ND	0.81	ND	ND	ND	ND	ND
Silver	MG/KG	ND	ND	ND	ND	ND	ND	ND	ND
Sodium	MG/KG	ND	ND	ND	ND	ND	ND	ND	24.2
Vanadium	MG/KG	9.6	11.9	20.5	11.2	13.2	6.2	4.6	14.0
Zinc	MG/KG	ND	3.7	5.4	ND	ND	0.86	ND	2.8

MG/KG - milligrams per kilogram

J - estimated

ND - not detected

TABLE 5-6
SUBSURFACE SOIL - POSITIVE DETECTION SUMMARY
SITE 1, FRENCH CREEK LIQUIDS DISPOSAL AREA
REMEDIAL INVESTIGATION CTO-0231
MCB, CAMP LEJEUNE, NORTH CAROLINA
TOTAL METALS

Sample ID:	1-GW16DW-07	1-GW17-05	1-GW17DW-05
Sample Depth:	13-15'	9-11'	9-11'
Date Sampled:	5/2/94	4/19/94	5/5/94

	<u>UNITS</u>			
Aluminum	MG/KG	2070	1870	3370
Antimony	MG/KG	7.6	ND	ND
Arsenic	MG/KG	ND	0.79	ND
Barium	MG/KG	3.1	8.1	6.6
Cadmium	MG/KG	0.62	ND	ND
Calcium	MG/KG	56.5	35900 J	331 J
Chromium	MG/KG	6.2	6.6	4.6
Cobalt	MG/KG	0.98	ND	ND
Copper	MG/KG	ND	3.9	ND
Iron	MG/KG	705	1620	909
Lead	MG/KG	3.0	14.5	2.6
Magnesium	MG/KG	30.8	602	132
Manganese	MG/KG	3.3	18.4	5.0
Mercury	MG/KG	ND	ND	ND
Nickel	MG/KG	2.5	2.6	1.5
Potassium	MG/KG	47.8 J	102 J	263 J
Selenium	MG/KG	ND	ND	ND
Silver	MG/KG	ND	ND	ND
Sodium	MG/KG	13.5	ND	ND
Vanadium	MG/KG	2.6	2.8	5.4
Zinc	MG/KG	1.1	15.0	ND

MG/KG - milligrams per kilogram

J - estimated

ND - not detected

TABLE 5-7
 SHALLOW AND DEEP GROUNDWATER - POSITIVE DETECTION SUMMARY
 ROUND 1
 SITE 1, FRENCH CREEK LIQUIDS DISPOSAL AREA
 REMEDIAL INVESTIGATION CTO - 0231
 MCB, CAMP LEJEUNE, NORTH CAROLINA
 TCL ORGANICS

Sample ID:	1-GW04-01	1-GW07-01	1-GW08-01	1-GW10-01	1-GW11-01	1-GW12-01	1-GW13-01
Date Sampled:	4/24/94	4/24/94	4/24/94	4/24/94	4/24/94	4/24/94	4/23/94
	<u>UNITS</u>						
<u>VOLATILES</u>							
Chloromethane	UG/L	ND	ND	ND	ND	ND	ND
Vinyl chloride	UG/L	ND	ND	ND	2	ND	ND
Acetone	UG/L	NA	NA	NA	NA	NA	NA
1,2-Dichloroethene(total)	UG/L	ND	ND	ND	10	ND	ND
Trichloroethene	UG/L	ND	ND	ND	4	1 J	ND
2-Chloroethylvinylether	UG/L	ND	ND	ND	ND	ND	ND
Xylene (total)	UG/L	ND	ND	ND	ND	3	ND
<u>SEMIVOLATILES</u>							
Phenol	UG/L	ND	ND	ND	ND	ND	ND
bis(2-Chloroethyl) ether	UG/L	ND	ND	ND	ND	ND	ND
2-Chlorophenol	UG/L	ND	ND	ND	ND	ND	ND
1,3-Dichlorobenzene	UG/L	ND	ND	ND	ND	ND	ND
1,4-Dichlorobenzene	UG/L	ND	ND	ND	ND	ND	ND
1,2-Dichlorobenzene	UG/L	ND	ND	ND	ND	ND	ND
2-Methylphenol	UG/L	ND	ND	ND	ND	ND	ND
2,2'-oxybis-(1-chloropropane)	UG/L	ND	ND	ND	ND	ND	ND
4-Methylphenol	UG/L	ND	ND	ND	ND	ND	ND
N-Nitroso-di-n-propylamine	UG/L	ND	ND	ND	ND	ND	ND
Hexachloroethane	UG/L	ND	ND	ND	ND	ND	ND
Nitrobenzene	UG/L	ND	ND	ND	ND	ND	ND
Isophorone	UG/L	ND	ND	ND	ND	ND	ND
2-Nitrophenol	UG/L	ND	ND	ND	ND	ND	ND
2,4-Dimethylphenol	UG/L	ND	ND	ND	ND	ND	ND
bis(2-Chloroethoxy) methane	UG/L	ND	ND	ND	ND	ND	ND
2,4-Dichlorophenol	UG/L	ND	ND	ND	ND	ND	ND
1,2,4-Trichlorobenzene	UG/L	ND	ND	ND	ND	ND	ND
Naphthalene	UG/L	ND	ND	ND	ND	ND	ND
4-Chloroaniline	UG/L	ND	ND	ND	ND	ND	ND

UG/L - micrograms per liter

J - estimated

ND - not detected

NA - not analyzed

R - rejected

TABLE 5-7
SHALLOW AND DEEP GROUNDWATER - POSITIVE DETECTION SUMMARY
ROUND 1
SITE 1, FRENCH CREEK LIQUIDS DISPOSAL AREA
REMEDIAL INVESTIGATION CTO - 0231
MCB, CAMP LEJEUNE, NORTH CAROLINA
TCL ORGANICS

Sample ID:	1-GW04-01	1-GW07-01	1-GW08-01	1-GW10-01	1-GW11-01	1-GW12-01	1-GW13-01
Date Sampled:	4/24/94	4/24/94	4/24/94	4/24/94	4/24/94	4/24/94	4/23/94

UNITS

SEMIVOLATILES Cont.

	UG/L	ND	ND	ND	ND	ND	ND	ND
Hexachlorobutadiene	UG/L	ND	ND	ND	ND	ND	ND	ND
4-Chloro-3-methylphenol	UG/L	ND	ND	ND	ND	ND	ND	ND
2-Methylnaphthalene	UG/L	ND	ND	ND	ND	ND	ND	ND
Hexachlorocyclopentadiene	UG/L	ND	ND	ND	ND	ND	ND	ND
2,4,6-Trichlorophenol	UG/L	ND	ND	ND	ND	ND	ND	ND
2,4,5-Trichlorophenol	UG/L	ND	ND	ND	ND	ND	ND	ND
2-Chloronaphthalene	UG/L	ND	ND	ND	ND	ND	ND	ND
2-Nitroaniline	UG/L	ND	ND	ND	ND	ND	ND	ND
Dimethyl phthalate	UG/L	ND	ND	ND	ND	ND	ND	ND
Acenaphthylene	UG/L	ND	ND	ND	ND	ND	ND	ND
2,6-Dinitrotoluene	UG/L	ND	ND	ND	ND	ND	ND	ND
3-Nitroaniline	UG/L	ND	ND	ND	ND	ND	ND	ND
Acenaphthene	UG/L	ND	ND	ND	ND	ND	ND	ND
2,4-Dinitrophenol	UG/L	ND	ND	ND	ND	ND	ND	ND
4-Nitrophenol	UG/L	25 R	25 R	25 R	25 R	25 R	25 R	ND
Dibenzofuran	UG/L	ND	ND	ND	ND	ND	ND	ND
2,4-Dinitrotoluene	UG/L	ND	ND	ND	ND	ND	ND	ND
Diethylphthalate	UG/L	ND	ND	ND	ND	ND	ND	ND
4-Chlorophenyl phenyl ether	UG/L	ND	ND	ND	ND	ND	ND	ND
Fluorene	UG/L	ND	ND	ND	ND	ND	ND	ND
4-Nitroaniline	UG/L	ND	ND	ND	ND	ND	ND	ND
4,6-Dinitro-2-methylphenol	UG/L	ND	ND	ND	ND	ND	ND	ND
N-nitrosodiphenylamine	UG/L	ND	ND	ND	ND	ND	ND	ND
4-Bromophenyl-phenylether	UG/L	ND	ND	ND	ND	ND	ND	ND
Hexachlorobenzene	UG/L	ND	ND	ND	ND	ND	ND	ND
Pentachlorophenol	UG/L	ND	ND	ND	ND	ND	ND	ND

UG/L - micrograms per liter
J - estimated
ND - not detected
NA - not analyzed
R - rejected

TABLE 5-7
 SHALLOW AND DEEP GROUNDWATER - POSITIVE DETECTION SUMMARY
 ROUND 1
 SITE 1, FRENCH CREEK LIQUIDS DISPOSAL AREA
 REMEDIAL INVESTIGATION CTO - 0231
 MCB, CAMP LEJEUNE, NORTH CAROLINA
 TCL ORGANICS

Sample ID:	1-GW04-01	1-GW07-01	1-GW08-01	1-GW10-01	1-GW11-01	1-GW12-01	1-GW13-01
Date Sampled:	4/24/94	4/24/94	4/24/94	4/24/94	4/24/94	4/24/94	4/23/94

UNITS

SEMIVOLATILES Cont.

Phenanthrene	UG/L	ND	ND	ND	ND	ND	ND	ND
Anthracene	UG/L	ND	ND	ND	ND	ND	ND	ND
Carbazole	UG/L	ND	ND	ND	ND	ND	ND	ND
di-n-Butylphthalate	UG/L	ND	ND	ND	ND	ND	ND	ND
Fluoranthene	UG/L	ND	ND	ND	ND	ND	ND	ND
Pyrene	UG/L	ND	ND	ND	ND	ND	ND	ND
Butyl benzyl phthalate	UG/L	ND	ND	ND	ND	ND	ND	ND
3,3'-Dichlorobenzidine	UG/L	10 R	10 R	10 R	10 R	10 R	10 R	ND
Benzo[a]anthracene	UG/L	ND	ND	ND	ND	ND	ND	ND
Chrysene	UG/L	ND	ND	ND	ND	ND	ND	ND
bis(2-Ethylhexyl)phthalate	UG/L	ND	ND	ND	ND	1 J	1 J	1 J
di-n-Octylphthalate	UG/L	ND	ND	ND	ND	ND	ND	ND
Benzo[b]fluoranthene	UG/L	ND	ND	ND	ND	ND	ND	ND
Benzo[k]fluoranthene	UG/L	ND	ND	ND	ND	ND	ND	ND
Benzo[a]pyrene	UG/L	ND	ND	ND	ND	ND	ND	ND
Indeno[1,2,3-cd]pyrene	UG/L	ND	ND	ND	ND	ND	ND	ND
Dibenz[a,h]anthracene	UG/L	ND	ND	ND	ND	ND	ND	ND
Benzo[g,h,i]perylene	UG/L	ND	ND	ND	ND	ND	ND	ND

UG/L - micrograms per liter
 J - estimated
 ND - not detected
 NA - not analyzed
 R - rejected

TABLE 5-7
 SHALLOW AND DEEP GROUNDWATER - POSITIVE DETECTION SUMMARY
 ROUND 1
 SITE 1, FRENCH CREEK LIQUIDS DISPOSAL AREA
 REMEDIAL INVESTIGATION CTO - 0231
 MCB, CAMP LEJEUNE, NORTH CAROLINA
 TCL ORGANICS

	Sample ID:	1-GW14-01	1-GW16DW-01	1-GW16-01	1-GW17DW-01	1-GW17-01
	Date Sampled:	4/24/94	5/9/94	4/24/94	5/25/94	4/24/94
	<u>UNITS</u>					
<u>VOLATILES</u>						
Chloromethane	UG/L	ND	1 J	ND	ND	ND
Vinyl chloride	UG/L	ND	ND	ND	ND	ND
Acetone	UG/L	NA	NA	NA	76	NA
1,2-Dichloroethene(total)	UG/L	ND	ND	ND	ND	1 J
Trichloroethene	UG/L	ND	ND	ND	ND	27
2-Chloroethylvinylether	UG/L	ND	2 R	ND	NA	ND
Xylene (total)	UG/L	ND	ND	ND	ND	ND
<u>SEMIVOLATILES</u>						
Phenol	UG/L	10 R	ND	ND	6 J	ND
bis(2-Chloroethyl) ether	UG/L	10 R	ND	ND	ND	ND
2-Chlorophenol	UG/L	10 R	ND	ND	ND	ND
1,3-Dichlorobenzene	UG/L	10 R	ND	ND	ND	ND
1,4-Dichlorobenzene	UG/L	10 R	ND	ND	ND	ND
1,2-Dichlorobenzene	UG/L	10 R	ND	ND	ND	ND
2-Methylphenol	UG/L	10 R	ND	ND	ND	ND
2,2'-oxybis-(1-chloropropane)	UG/L	10 R	ND	ND	ND	ND
4-Methylphenol	UG/L	10 R	ND	ND	ND	ND
N-Nitroso-di-n-propylamine	UG/L	10 R	ND	ND	ND	ND
Hexachloroethane	UG/L	10 R	ND	ND	ND	ND
Nitrobenzene	UG/L	10 R	ND	ND	ND	ND
Isophorone	UG/L	10 R	ND	ND	ND	ND
2-Nitrophenol	UG/L	10 R	ND	ND	ND	ND
2,4-Dimethylphenol	UG/L	10 R	ND	ND	ND	ND
bis(2-Chloroethoxy) methane	UG/L	10 R	ND	ND	ND	ND
2,4-Dichlorophenol	UG/L	10 R	ND	ND	ND	ND
1,2,4-Trichlorobenzene	UG/L	10 R	ND	ND	ND	ND
Naphthalene	UG/L	10 R	ND	ND	ND	ND
4-Chloroaniline	UG/L	10 R	ND	ND	ND	ND

UG/L - micrograms per liter

J - estimated

ND - not detected

NA - not analyzed

R - rejected

TABLE 5-7
 SHALLOW AND DEEP GROUNDWATER - POSITIVE DETECTION SUMMARY
 ROUND 1
 SITE 1, FRENCH CREEK LIQUIDS DISPOSAL AREA
 REMEDIAL INVESTIGATION CTO - 0231
 MCB, CAMP LEJEUNE, NORTH CAROLINA
 TCL ORGANICS

Sample ID:	1-GW14-01	1-GW16DW-01	1-GW16-01	1-GW17DW-01	1-GW17-01
Date Sampled:	4/24/94	5/9/94	4/24/94	5/25/94	4/24/94

UNITS

SEMIVOLATILES Cont.

Hexachlorobutadiene	UG/L	10 R	ND	ND	ND	ND
4-Chloro-3-methylphenol	UG/L	10 R	ND	ND	ND	ND
2-Methylnaphthalene	UG/L	10 R	ND	ND	ND	ND
Hexachlorocyclopentadiene	UG/L	10 R	ND	ND	ND	ND
2,4,6-Trichlorophenol	UG/L	10 R	ND	ND	ND	ND
2,4,5-Trichlorophenol	UG/L	25 R	ND	ND	ND	ND
2-Chloronaphthalene	UG/L	10 R	ND	ND	ND	ND
2-Nitroaniline	UG/L	25 R	ND	ND	ND	ND
Dimethyl phthalate	UG/L	10 R	ND	ND	ND	ND
Acenaphthylene	UG/L	10 R	ND	ND	ND	ND
2,6-Dinitrotoluene	UG/L	10 R	ND	ND	ND	ND
3-Nitroaniline	UG/L	25 R	ND	ND	ND	ND
Acenaphthene	UG/L	10 R	ND	ND	ND	ND
2,4-Dinitrophenol	UG/L	25 R	ND	ND	ND	ND
4-Nitrophenol	UG/L	25 R	ND	ND	ND	ND
Dibenzofuran	UG/L	10 R	ND	ND	ND	ND
2,4-Dinitrotoluene	UG/L	10 R	ND	ND	ND	ND
Diethylphthalate	UG/L	10 R	ND	ND	1 J	ND
4-Chlorophenyl phenyl ether	UG/L	10 R	ND	ND	ND	ND
Fluorene	UG/L	10 R	ND	ND	ND	ND
4-Nitroaniline	UG/L	25 R	ND	ND	ND	ND
4,6-Dinitro-2-methylphenol	UG/L	25 R	ND	ND	ND	ND
N-nitrosodiphenylamine	UG/L	10 R	ND	ND	ND	ND
4-Bromophenyl-phenylether	UG/L	10 R	ND	ND	ND	ND
Hexachlorobenzene	UG/L	10 R	ND	ND	ND	ND
Pentachlorophenol	UG/L	25 R	ND	ND	ND	ND

UG/L - micrograms per liter
 J - estimated
 ND - not detected
 NA - not analyzed
 R - rejected

TABLE 5-7
 SHALLOW AND DEEP GROUNDWATER - POSITIVE DETECTION SUMMARY
 ROUND 1
 SITE 1, FRENCH CREEK LIQUIDS DISPOSAL AREA
 REMEDIAL INVESTIGATION CTO - 0231
 MCB, CAMP LEJEUNE, NORTH CAROLINA
 TCL ORGANICS

Sample ID:	1-GW14-01	1-GW16DW-01	1-GW16-01	1-GW17DW-01	1-GW17-01
Date Sampled:	4/24/94	5/9/94	4/24/94	5/25/94	4/24/94

UNITS

SEMIVOLATILES Cont.

Phenanthrene	UG/L	10 R	ND	ND	ND	ND
Anthracene	UG/L	10 R	ND	ND	ND	ND
Carbazole	UG/L	10 R	ND	ND	ND	ND
di-n-Butylphthalate	UG/L	10 R	ND	ND	ND	ND
Fluoranthene	UG/L	10 R	ND	ND	ND	ND
Pyrene	UG/L	10 R	ND	ND	ND	ND
Butyl benzyl phthalate	UG/L	10 R	ND	ND	ND	ND
3,3'-Dichlorobenzidine	UG/L	10 R	ND	ND	ND	ND
Benzo[a]anthracene	UG/L	10 R	ND	ND	ND	ND
Chrysene	UG/L	10 R	ND	ND	ND	ND
bis(2-Ethylhexyl)phthalate	UG/L	3 J	30 J	1 J	ND	ND
di-n-Octylphthalate	UG/L	10 R	ND	ND	ND	ND
Benzo[b]fluoranthene	UG/L	10 R	ND	ND	ND	ND
Benzo[k]fluoranthene	UG/L	10 R	ND	ND	ND	ND
Benzo[a]pyrene	UG/L	10 R	ND	ND	ND	ND
Indeno[1,2,3-cd]pyrene	UG/L	10 R	ND	ND	ND	ND
Dibenz[a,h]anthracene	UG/L	10 R	ND	ND	ND	ND
Benzo[g,h,i]perylene	UG/L	10 R	ND	ND	ND	ND

UG/L - micrograms per liter

J - estimated

ND - not detected

NA - not analyzed

R - rejected

TABLE 5-8
SHALLOW AND DEEP GROUNDWATER - POSITIVE DETECTION SUMMARY
ROUND 1
SITE 1, FRENCH CREEK LIQUIDS DISPOSAL AREA
REMEDIAL INVESTIGATION CTO - 0231
MCB, CAMP LEJEUNE, NORTH CAROLINA
TOTAL METALS

Sample ID:	1-GW01-01	1-GW02-01	1-GW03-01	1-GW04-01	1-GW06-01	1-GW07-01	1-GW08-01	
Date Sampled:	4/22/94	4/22/94	4/22/94	4/24/94	4/23/94	4/24/94	4/24/94	
	<u>UNITS</u>							
Aluminum	UG/L	108000	192000 J	77400 J	62500 J	91100 J	28000 J	63800 J
Antimony	UG/L	34.3	ND	ND	ND	ND	ND	88.6 J
Arsenic	UG/L	130	168	10.2	13.4	8.6	9.1	11.2
Barium	UG/L	327	454	134	261	178	141	140
Beryllium	UG/L	19.3	20.7	ND	5.0	ND	ND	ND
Cadmium	UG/L	27.7	30.6	ND	5.6	3.8	7.0	ND
Calcium	UG/L	653000	274000	26200	16300	5130	6970	16800
Chromium	UG/L	399 J	414 J	76.6 J	226 J	82.9 J	59.8 J	80.7 J
Cobalt	UG/L	87.8	51.3	7.2	49.4	ND	ND	8.2
Copper	UG/L	54.7	47.1	14.1	24.5	18.4	8.3	7.0
Iron	UG/L	248000	284000 J	26500	68700	19200 J	14700	16000
Lead	UG/L	59.8	124 J	27.1	26.1	35.1 J	16.6	33.1
Magnesium	UG/L	18300	16400	5890	12500	4730	5810	8450
Manganese	UG/L	983	1030	74.2	380	66.8	47.2	73.5
Mercury	UG/L	0.19 J	0.50	0.24	ND	ND	ND	ND
Nickel	UG/L	166	162	20.3	126	15.6	18.6	24.6
Potassium	UG/L	12000	10700 J	3170 J	6350 J	4880 J	3320 J	4510 J
Selenium	UG/L	5.8 J	7.5 J	ND	ND	ND	ND	ND
Silver	UG/L	ND	15.1 J	ND	ND	ND	ND	ND
Sodium	UG/L	12800	7530	5770	9380	7920	5880	5810
Thallium	UG/L	ND	ND	ND	ND	ND	ND	ND
Vanadium	UG/L	326	367	107 J	205 J	88.2	63.6 J	58.3 J
Zinc	UG/L	466	501	42.9	299	88.7	26.2	53.2

UG/L - micrograms per liter
 J - estimated
 ND - not detected

TABLE 5-8
SHALLOW AND DEEP GROUNDWATER - POSITIVE DETECTION SUMMARY
ROUND 1
SITE 1, FRENCH CREEK LIQUIDS DISPOSAL AREA
REMEDIAL INVESTIGATION CTO - 0231
MCB, CAMP LEJEUNE, NORTH CAROLINA
TOTAL METALS

Sample ID:	1-GW09-01	1-GW10-01	1-GW11-01	1-GW12-01	1-GW13-01	1-GW14-01	1-GW15-01	
Date Sampled:	4/24/94	4/24/94	4/24/94	4/24/94	4/23/94	4/24/94	4/23/94	
	<u>UNITS</u>							
Aluminum	UG/L	301000 J	269000 J	158000 J	457000 J	132000 J	430000 J	133000 J
Antimony	UG/L	ND	ND	40.9 J	ND	ND	ND	56.6 J
Arsenic	UG/L	197	330	78.7	71.6	105	39.1	292
Barium	UG/L	1080	2470	376	628	222	590	726
Beryllium	UG/L	33.1	99.1	24.5	6.8	1.7	4.7	50.1
Cadmium	UG/L	43.1	41.8	13.2	12.0	12.0	6.9	34.2
Calcium	UG/L	116000	231000	385000	6800	3270	5740	720000
Chromium	UG/L	408 J	395 J	398 J	800 J	153 J	394 J	594 J
Cobalt	UG/L	85.3	306	87.9	24.7	6.5 J	22.2	71.2
Copper	UG/L	65.3	82.3	47.1	105	33.3	79.4	47.8
Iron	UG/L	417000	281000	200000	227000	105000 J	110000	338000 J
Lead	UG/L	113	91.4	62.7	163	74.4 J	163	79.1 J
Magnesium	UG/L	10200	13400	16100	19300	7670	18700	30900
Manganese	UG/L	1750	1920	2250	261	318	250	1320
Mercury	UG/L	0.87	0.20	ND	0.22	ND	ND	0.53
Nickel	UG/L	293	866	141	96.3	23.5	43.4 J	259
Potassium	UG/L	7200 J	12400 J	7900 J	17500 J	7910 J	21600 J	17700 J
Selenium	UG/L	ND	ND	ND	22.6	17.6 J	4.5	ND
Silver	UG/L	19.9 J	ND	ND	7.7 J	ND	ND	8.2 J
Sodium	UG/L	3520	6680	7050	13800	4510	6320	5080
Thallium	UG/L	ND	ND	ND	ND	ND	4.7	ND
Vanadium	UG/L	530 J	328 J	414 J	811 J	257	500 J	479
Zinc	UG/L	996	2410	514	301	94.4	201	935

UG/L - micrograms per liter
 J - estimated
 ND - not detected

TABLE 5-8
 SHALLOW AND DEEP GROUNDWATER - POSITIVE DETECTION SUMMARY
 ROUND 1
 SITE 1, FRENCH CREEK LIQUIDS DISPOSAL AREA
 REMEDIAL INVESTIGATION CTO - 0231
 MCB, CAMP LEJEUNE, NORTH CAROLINA
 TOTAL METALS

Sample ID:	1-GW16DW-01	1-GW16-01	1-GW17DW-01	1-GW17-01	1-HP638-01	
Date Sampled:	5/9/94	4/24/94	5/25/94	4/24/94	4/11/94	
	<u>UNITS</u>					
Aluminum	UG/L	347	99700 J	409 J	22500 J	ND
Antimony	UG/L	ND	ND	ND	ND	52.2
Arsenic	UG/L	ND	13.0	ND	22.0	ND
Barium	UG/L	12.9	278	11.0	142	8.3
Beryllium	UG/L	ND	1.0	ND	23.8	ND
Cadmium	UG/L	ND	3.1	ND	5.0	ND
Calcium	UG/L	41600	25600	42100	190000	42600
Chromium	UG/L	ND	79.0 J	ND	97.5 J	ND
Cobalt	UG/L	ND	10.4	ND	24.5	ND
Copper	UG/L	ND	18.6	ND	11.6	6.0
Iron	UG/L	479	25400	642 J	32000	959
Lead	UG/L	ND	40.7	ND	16.7	ND
Magnesium	UG/L	671	11100	699	9240	1090
Manganese	UG/L	9.6	83.6	ND	550	17.2
Mercury	UG/L	ND	ND	ND	0.15	ND
Nickel	UG/L	10.0	17.8 J	ND	48.2 J	ND
Potassium	UG/L	983	4290 J	1440 J	6350 J	1290
Selenium	UG/L	ND	ND	ND	ND	ND
Silver	UG/L	ND	ND	ND	ND	ND
Sodium	UG/L	13600	7670	9980	4830	6220
Thallium	UG/L	ND	ND	ND	ND	ND
Vanadium	UG/L	ND	119 J	4.2	82.8 J	ND
Zinc	UG/L	ND	47.5	9.2	334	ND

UG/L - micrograms per liter

J - estimated

ND - not detected

TABLE 5-9
SHALLOW AND DEEP GROUNDWATER - POSITIVE DETECTION SUMMARY
ROUND 1
SITE 1, FRENCH CREEK LIQUIDS DISPOSAL AREA
REMEDIAL INVESTIGATION CTO - 0231
MCB, CAMP LEJEUNE, NORTH CAROLINA
DISSOLVED METALS

Sample ID:	1-GW01D-01	1-GW02D-01	1-GW03D-01	1-GW04D-01	1-GW06D-01	1-GW07D-01	1-GW08D-01	
Date Sampled:	4/22/94	4/22/94	4/22/94	4/24/94	4/23/94	4/24/94	4/24/94	
	<u>UNITS</u>							
Aluminum	UG/L	36.4	ND	47.9 J	64.4 J	ND	35.6 J	ND
Antimony	UG/L	49.0	64.9 J	46.6 J	ND	ND	ND	58.3 J
Arsenic	UG/L	4.7	ND	ND	ND	ND	ND	ND
Barium	UG/L	21.5	26.2	ND	36.6	8.2	ND	ND
Calcium	UG/L	70000	136000	24300	13700	2520	5920	17000
Cobalt	UG/L	ND	ND	ND	4.6	ND	ND	ND
Copper	UG/L	ND	ND	ND	ND	ND	ND	ND
Iron	UG/L	5200	1270 J	ND	171	ND	ND	ND
Magnesium	UG/L	2140	4020	4510	5920	1400	3340	4770
Manganese	UG/L	400	452	8.1	12.4	ND	20.8	11.9
Nickel	UG/L	ND	ND	ND	ND	ND	8.7	ND
Potassium	UG/L	1430	1290 J	933 J	832 J	1150 J	1210 J	720 J
Sodium	UG/L	12400	7740	6020	9630	8320	5640	5470
Thallium	UG/L	ND	ND	ND	ND	ND	ND	ND
Zinc	UG/L	ND	ND	7.1	12.4	ND	6.7	6.2

UG/L - micrograms per liter
 J - estimated
 ND - not detected

TABLE 5-9
SHALLOW AND DEEP GROUNDWATER - POSITIVE DETECTION SUMMARY
ROUND 1
SITE 1, FRENCH CREEK LIQUIDS DISPOSAL AREA
REMEDIAL INVESTIGATION CTO - 0231
MCB, CAMP LEJEUNE, NORTH CAROLINA
DISSOLVED METALS

	Sample ID:	1-GW09D-01	1-GW10D-01	1-GW11D-01	1-GW12D-01	1-GW13D-01	1-GW14D-01	1-GW15D-01
	Date Sampled:	4/24/94	4/24/94	4/26/94	4/24/94	4/23/94	4/24/94	4/23/94
	<u>UNITS</u>							
Aluminum	UG/L	797 J	120 J	48.8 J	110 J	ND	55.9 J	ND
Antimony	UG/L	ND	ND	90.6 J	57.5 J	56.7 J	ND	51.4
Arsenic	UG/L	ND	4.4	ND	ND	ND	ND	ND
Barium	UG/L	ND	38.1	16.3	ND	29.5	54.8	28.2
Calcium	UG/L	24200	105000	112000	2540	1690	2720	107000
Cobalt	UG/L	ND	35.0	11.8	ND	ND	ND	ND
Copper	UG/L	ND	ND	ND	ND	ND	ND	ND
Iron	UG/L	525	5270	564	18800	ND	ND	ND
Magnesium	UG/L	1180	4140	4310	2010	1830	2190	3000
Manganese	UG/L	7.1	1070	1070	23.8	37.8	6.4 J	1.6
Nickel	UG/L	8.6	20.8	ND	ND	ND	ND	ND
Potassium	UG/L	326 J	1250 J	843 J	933 J	1190 J	1440 J	1910
Sodium	UG/L	3180	6160	7040	15000	4910	6950	3830
Thallium	UG/L	ND	ND	ND	ND	ND	ND	ND
Zinc	UG/L	6.1	13.4	ND	19.5	ND	12.9	ND

UG/L - micrograms per liter
 J - estimated
 ND - not detected

TABLE 5-9
SHALLOW AND DEEP GROUNDWATER - POSITIVE DETECTION SUMMARY
ROUND 1
SITE 1, FRENCH CREEK LIQUIDS DISPOSAL AREA
REMEDIAL INVESTIGATION CTO - 0231
MCB, CAMP LEJEUNE, NORTH CAROLINA
DISSOLVED METALS

	Sample ID:	1-GW16DWD-01	1-GW16D-01	1-GW17DWD-01	1-GW17D-01	1-HP638D-01
	Date Sampled:	5/9/94	4/24/94	5/25/94	4/24/94	4/11/94
	<u>UNITS</u>					
Aluminum	UG/L	ND	72.8 J	ND	ND	ND
Antimony	UG/L	ND	ND	ND	ND	ND
Arsenic	UG/L	ND	ND	ND	ND	ND
Barium	UG/L	10.5	37.3	7.4	47.0	ND
Calcium	UG/L	28600	23900	15900	118000	39200
Cobalt	UG/L	ND	4.1	ND	5.4	ND
Copper	UG/L	ND	6.8	ND	ND	ND
Iron	UG/L	ND	126 J	ND	ND	ND
Magnesium	UG/L	512	8990	422	5680	1060
Manganese	UG/L	ND	36.2	ND	364	15.3
Nickel	UG/L	10.8	ND	ND	ND	ND
Potassium	UG/L	972	1030 J	1320 J	3180 J	1210
Sodium	UG/L	13900	8100	9980	4980	5890
Thallium	UG/L	ND	ND	ND	4.8	ND
Zinc	UG/L	ND	12.6	3.9	8.3	ND

UG/L - micrograms per liter
 J - estimated
 ND - not detected

TABLE 5-10
SHALLOW AND DEEP GROUNDWATER - POSITIVE DETECTION SUMMARY
ROUND 2
SITE 1, FRENCH CREEK LIQUIDS DISPOSAL AREA
REMEDIAL INVESTIGATION CTO - 0231
MCB, CAMP LEJEUNE, NORTH CAROLINA
TCL ORGANICS

Sample ID:	1-GW10-02	1-GW11-02	1-GW12-02	1-GW17-02
Date Sampled:	11/11/94	11/12/94	11/12/94	11/16/94

UNITS

VOLATILES

Vinyl Chloride	UG/L	4 J	ND	ND	ND
Acetone	UG/L	14	9 J	ND	ND
1,1-Dichloroethene	UG/L	2 J	ND	ND	ND
1,2-Dichloroethene (total)	UG/L	21	ND	ND	ND
Trichloroethene	UG/L	8 J	ND	ND	18
Toluene	UG/L	ND	ND	1 J	ND
Xylene (total)	UG/L	ND	ND	19	ND

UG/L - micrograms per liter
 J - estimated
 ND - not detected

TABLE 5-11
SHALLOW AND DEEP GROUNDWATER - POSITIVE DETECTION SUMMARY
ROUND 2
SITE 1, FRENCH CREEK LIQUIDS DISPOSAL AREA
REMEDIAL INVESTIGATION CTO - 0231
MCB, CAMP LEJEUNE, NORTH CAROLINA
TOTAL METALS

	Sample ID:	1-GW01-02	1-GW02-02	1-GW03-02	1-GW04-02	1-GW06-02	1-GW07-02	1-GW08-02
	Date Sampled:	11/12/94	11/12/94	11/12/94	11/14/94	11/13/94	11/14/94	11/13/94
<u>UNITS</u>								
Aluminum	UG/L	ND	ND	ND	433	ND	ND	476
Arsenic	UG/L	11.4	13.1	ND	ND	ND	ND	ND
Barium	UG/L	25	28.7	23.9	41.6	21.2	14.1	9.2
Calcium	UG/L	95200 J	127000 J	23100 J	35500	3420 J	900	17500 J
Cobalt	UG/L	ND	ND	ND	ND	ND	ND	ND
Iron	UG/L	22600 J	13400 J	ND	519	ND	ND	ND
Lead	UG/L	ND	ND	ND	ND	ND	ND	2.4
Magnesium	UG/L	2490 J	3280 J	4400 J	6080	2470 J	880	4580 J
Manganese	UG/L	449 J	465 J	7.2 J	ND	20.6 J	ND	3.3 J
Mercury	UG/L	0.19 J	0.21 J	0.15 J	1.2	0.28 J	0.17	0.13 R
Potassium	UG/L	1560	1130	899	1050	621	754	572
Sodium	UG/L	10800 J	6510 J	4250 J	8940	6550 J	1410	4250 J
Vanadium	UG/L	ND	ND	ND	ND	ND	ND	ND

UG/L - micrograms per liter
 J - estimated
 R - rejected

TABLE 5-11
SHALLOW AND DEEP GROUNDWATER - POSITIVE DETECTION SUMMARY
ROUND 2
SITE 1, FRENCH CREEK LIQUIDS DISPOSAL AREA
REMEDIAL INVESTIGATION CTO - 0231
MCB, CAMP LEJEUNE, NORTH CAROLINA
TOTAL METALS

	Sample ID:	1-GW09-02	1-GW10-02	1-GW11-02	1-GW12-02	1-GW13-02	1-GW15-02	1-GW16-02
	Date Sampled:	11/13/94	11/11/94	11/12/94	11/12/94	11/13/94	11/12/94	11/14/94
<u>UNITS</u>								
Aluminum	UG/L	513	ND	ND	1510	416	ND	690
Arsenic	UG/L	ND	15.2	8.9	13.8	ND	ND	ND
Barium	UG/L	40	44.5	33.8	40.4	30.4	53.2	41
Calcium	UG/L	29200 J	111000	95900 J	2570 J	1240 J	13700	13100
Cobalt	UG/L	ND	30	14.1	ND	ND	ND	ND
Iron	UG/L	479 J	21300	15200 J	29200 J	ND	ND	ND
Lead	UG/L	ND	ND	ND	ND	1.4	ND	ND
Magnesium	UG/L	1660 J	3840	3170 J	4630 J	1810 J	3480	7090
Manganese	UG/L	3.5 J	1200	1070 J	18.3 J	13.5 J	3.1	ND
Mercury	UG/L	0.12 R	0.15	0.12 R	0.59 J	0.13 R	ND	0.2
Potassium	UG/L	305	1220	921	545	1020	4960	805
Sodium	UG/L	2980 J	6130	6030 J	19200 J	4930 J	3770	9200
Vanadium	UG/L	ND	ND	ND	11.4	ND	ND	ND

UG/L - micrograms per liter
 J - estimated
 R - rejected

TABLE 5-11
SHALLOW AND DEEP GROUNDWATER - POSITIVE DETECTION SUMMARY
ROUND 2
SITE 1, FRENCH CREEK LIQUIDS DISPOSAL AREA
REMEDIAL INVESTIGATION CTO - 0231
MCB, CAMP LEJEUNE, NORTH CAROLINA
TOTAL METALS

	Sample ID:	1-GW17-02	1-HP-638-02	1-GW16DW-02	1-GW17DW-02
	Date Sampled:	11/16/94	11/11/94	11/14/94	11/16/94
	<u>UNITS</u>				
Aluminum	UG/L	ND	ND	ND	ND
Arsenic	UG/L	ND	ND	ND	ND
Barium	UG/L	76.6	7.9	31.1	21.3
Calcium	UG/L	121000	43700	33500	29100
Cobalt	UG/L	ND	ND	ND	ND
Iron	UG/L	263	712	ND	ND
Lead	UG/L	ND	ND	ND	ND
Magnesium	UG/L	4280	1060	905	550
Manganese	UG/L	95.1	13.5	ND	2.5
Mercury	UG/L	0.14	ND	0.29	ND
Potassium	UG/L	5180	1140	990	935
Sodium	UG/L	9220	5660	6120	4230
Vanadium	UG/L	3.6	ND	ND	ND

UG/L - micrograms per liter
 J - estimated
 R - rejected

TABLE 5-12
 SHALLOW AND DEEP GROUNDWATER - POSITIVE DETECTION SUMMARY
 ROUND 2
 SITE 1, FRENCH CREEK LIQUIDS DISPOSAL AREA
 REMEDIAL INVESTIGATION CTO - 0231
 MCB, CAMP LEJEUNE, NORTH CAROLINA
 DISSOLVED METALS

	Sample ID:	1-GW01D-02	1-GW02D-02	1-GW03D-02	1-GW04D-02	1-GW06D-02	1-GW07D-02	1-GW08D-02
	Date Sampled:	11/12/94	11/12/94	11/12/94	11/14/94	11/13/94	11/14/94	11/13/94
	<u>UNITS</u>							
Arsenic	UG/L	4	3.9	ND	ND	ND	ND	ND
Barium	UG/L	18.8	24.6	20.6	43.6	14	5.6	7.6
Calcium	UG/L	83300 J	113000 J	20600 J	39300	3090 J	876	18500 J
Cobalt	UG/L	ND	ND	ND	ND	ND	ND	ND
Copper	UG/L	14.1	8.3	18.1	10.9	9.4	9.4	10.6
Iron	UG/L	17700 J	9360 J	ND	ND	ND	ND	ND
Lead	UG/L	ND	ND	ND	ND	ND	ND	ND
Magnesium	UG/L	2490 J	2990 J	4020 J	6670	2180 J	659	4800 J
Manganese	UG/L	464 J	420 J	7.4 J	ND	4.6 J	ND	4.1 J
Mercury	UG/L	0.1 R	0.12 R	0.13 R	ND	0.13 R	0.66	0.13 J
Nickel	UG/L	ND	ND	ND	ND	ND	ND	ND
Potassium	UG/L	1640	1060	884	1090	597	647	641
Silver	UG/L	4 R	4 R	4 R	ND	4 R	ND	4 R
Sodium	UG/L	10400 J	5850 J	3940 J	9950	5930 J	1230	4490 J
Vanadium	UG/L	ND	ND	ND	ND	ND	ND	ND

UG/L - micrograms per liter
 J - estimated
 ND - not detected
 R - rejected

TABLE 5-12
 SHALLOW AND DEEP GROUNDWATER - POSITIVE DETECTION SUMMARY
 ROUND 2
 SITE 1, FRENCH CREEK LIQUIDS DISPOSAL AREA
 REMEDIAL INVESTIGATION CTO - 0231
 MCB, CAMP LEJEUNE, NORTH CAROLINA
 DISSOLVED METALS

	Sample ID:	1-GW09D-02	1-GW10D-02	1-GW11D-02	1-GW12D-02	1-GW13D-02	1-GW15D-02	1-GW16D-02
	Date Sampled:	11/13/94	11/11/94	11/12/94	11/12/94	11/13/94	11/12/94	11/14/94
	<u>UNITS</u>							
Arsenic	UG/L	ND	13.4	ND	11.9	ND	ND	ND
Barium	UG/L	35.6	39.4	27.3	21.5	26.4	46.2	42
Calcium	UG/L	30100 J	113000	94000 J	2510 J	1590 J	127000	13300
Cobalt	UG/L	ND	29.6	13.4	ND	ND	ND	ND
Copper	UG/L	9.2	7.3	8.7	7.6	8.9	7	11.8
Iron	UG/L	ND	20200	8220 J	24100 J	ND	ND	ND
Lead	UG/L	ND	ND	3	ND	ND	ND	ND
Magnesium	UG/L	1780 J	3990	3180 J	4080 J	2080 J	3290	7440
Manganese	UG/L	2.3 J	1220	1040 J	16.6 J	14.6 J	ND	ND
Mercury	UG/L	0.41 J	0.14	R	0.18 J	0.13 R	ND	0.44
Nickel	UG/L	ND	15.1	ND	ND	ND	ND	ND
Potassium	UG/L	365	1330	950	542	1310	4690	912
Silver	UG/L	4 R	ND	4 R	4.2 J	4 R	ND	ND
Sodium	UG/L	3310 J	6410	5900 J	17400 J	6160 J	3610	9500
Vanadium	UG/L	ND	ND	ND	3.9	ND	ND	ND

UG/L - micrograms per liter
 J - estimated
 ND - not detected
 R - rejected

TABLE 5-12
SHALLOW AND DEEP GROUNDWATER - POSITIVE DETECTION SUMMARY
ROUND 2
SITE 1, FRENCH CREEK LIQUIDS DISPOSAL AREA
REMEDIAL INVESTIGATION CTO - 0231
MCB, CAMP LEJEUNE, NORTH CAROLINA
DISSOLVED METALS

	Sample ID:	1-GW17D-02	1-HP-638D-02	1-GW16DWD-02	1-GW17DWD-02
	Date Sampled:	11/16/94	11/11/94	11/14/94	11/16/94
	<u>UNITS</u>				
Arsenic	UG/L	ND	ND	ND	ND
Barium	UG/L	79.8	13	27.5	19.4
Calcium	UG/L	125000	49500	31200	29700
Cobalt	UG/L	ND	ND	ND	ND
Copper	UG/L	7.7	17.9	13.6	7.4
Iron	UG/L	ND	ND	ND	ND
Lead	UG/L	ND	ND	ND	ND
Magnesium	UG/L	4490	1260	898	587
Manganese	UG/L	101	16	ND	ND
Mercury	UG/L	0.14	ND	0.72	ND
Nickel	UG/L	ND	ND	ND	ND
Potassium	UG/L	5470	1440	1040	1080
Silver	UG/L	ND	ND	ND	ND
Sodium	UG/L	10100	6730	6050	4460
Vanadium	UG/L	3.1	ND	ND	ND

UG/L - micrograms per liter
 J - estimated
 ND - not detected
 R - rejected

TABLE 5-13

**COMPARISON OF GROUNDWATER ANALYTICAL RESULTS
SITE 1, FRENCH CREEK LIQUIDS DISPOSAL AREA
REMEDIAL INVESTIGATION, CTO-0231
MCB, CAMP LEJEUNE, NORTH CAROLINA**

Detected Contaminants	Round 1 Results				Round 2 Results			
	Min.	Max.	Freq.	Max. Location	Min.	Max.	Freq.	Max. Location
Volatiles								
Vinyl Chloride	2	2	1/19	1-GW10	4 J	4 J	1/4	1-GW10
1,1-Dichloroethene	ND	ND	0/19	NA	2 J	2 J	1/4	1-GW10
1,2-Dichloroethene	1 J	10	2/19	1-GW10	21	21	1/4	1-GW10
Trichloroethene	1	27	3/19	1-GW17	8 J	18	2/4	1-GW17
Xylenes (total)	3	3	1/19	1-GW12	19	19	1/4	1-GW12
Semivolatiles								
Phenol	6 J	6 J	1/19	1-GW17DW	ND	ND	0/1	NA
Diethylphthalate	1 J	1 J	1/19	1-GW17DW	ND	ND	0/1	NA
Total Metals								
Aluminum	347	457,000 J	18/19	1-GW12	416	1,510	6/18	1-GW12
Antimony	34.3	88.6 J	5/19	1-GW08	ND	ND	0/18	NA
Arsenic	8.6	330	16/19	1-GW10	8.9	15.2	5/18	1-GW10
Barium	8.3	2,470	19/19	1-GW10	7.9	76.6	18/18	1-GW17
Beryllium	1	99.1	12/19	1-GW10	ND	ND	0/18	NA
Cadmium	3.1	43.1	14/19	1-GW09	ND	ND	0/18	NA
Calcium	3,270	720,000	19/19	1-GW15	900	137,000	18/18	1-GW15
Chromium	59.8 J	800 J	16/19	1-GW12	ND	ND	0/18	NA
Cobalt	6.5 J	306	14/19	1-GW10	14.1	30	2/18	1-GW10
Copper	6	105	17/19	1-GW12	ND	ND	0/18	NA
Iron	479	417,000	19/19	1-GW09	263	29200 J	9/18	1-GW12
Lead	16.6	163	16/19	1-GW14	1.4	2.4	2/18	1-GW08
Magnesium	671	30,900	19/19	1-GW15	550	7,090	18/18	1-GW16
Manganese	9.6	2,250	18/19	1-GW11	2.5	1,200	14/18	1-GW10
Mercury	0.15	0.87	8/19	1-GW09	0.14	1.2	11/14	1-GW04
Nickel	10	866	17/19	1-GW10	ND	ND	0/18	NA
Potassium	983	21,600 J	19/19	1-GW14	305	5,180	18/18	1-GW17
Selenium	4.5	22.6	5/19	1-GW12	ND	ND	0/18	NA
Silver	7.7 J	19.9 J	4/19	1-GW09	ND	ND	0/18	NA
Sodium	3,520	13,800	19/19	1-GW12	1,410	19200 J	18/18	1-GW12
Thallium	4.7	4.7	1/19	1-GW14	ND	ND	0/18	NA
Vanadium	4.2	811 J	17/19	1-GW12	3.6	11.4	2/18	1-GW12
Zinc	9.2	2,410	17/19	1-GW10	ND	ND	0/18	NA

TABLE 5-13 (Continued)

COMPARISON OF GROUNDWATER ANALYTICAL RESULTS
 SITE 1, FRENCH CREEK LIQUIDS DISPOSAL AREA
 REMEDIAL INVESTIGATION, CTO-0231
 MCB, CAMP LEJEUNE, NORTH CAROLINA

Detected Contaminants	Round 1 Results				Round 2 Results			
	Min.	Max.	Freq.	Max. Location	Min.	Max.	Freq.	Max. Location
Dissolved Metals								
Aluminum	35.6 J	797 J	10/19	1-GW09	ND	ND	0/18	NA
Antimony	46.6 J	90.6 J	8/19	1-GW11	ND	ND	0/18	NA
Arsenic	4.4	4.7	2/19	1-GW01	3.9	13.4	4/18	1-GW10
Barium	7.4	54.8	13/19	1-GW14	5.6	79.8	18/18	1-GW17
Calcium	1,690	136,000	19/19	1-GW02	876	127,000	18/18	1-GW15
Cobalt	4.1	35	5/19	1-GW10	13.4	29.6	2/18	1-GW10
Copper	6.8	6.8	1/19	1-GW16	7.0	18.1	18/18	1-GW03
Iron	126 J	18,800	8/19	1-GW12	8220 J	24100 J	5/18	1-GW12
Lead	ND	ND	0/19	NA	3.0	3.0	1/18	1-GW11
Magnesium	422	8,990	19/19	1-GW16	587	7,440	18/18	1-GW16
Manganese	1.6	1,070	16/19	1-GW11	2.3 J	1,220	12/18	1-GW10
Mercury	ND	ND	0/19	NA	0.13 J	0.72	8/12	1-GW16DW
Nickel	8.6	20.8	4/19	1-GW10	15.1	15.1	1/18	1-GW10
Potassium	326 J	3,180 J	19/19	1-GW17	365	5,470	18/18	1-GW17
Silver	ND	ND	0/19	NA	4.2 J	4.2 J	1/10	1-GW12
Sodium	3,180	15,000	19/19	1-GW12	1,230	17400 J	18/18	1-GW12
Thallium	4.8	4.8	1/19	1-GW17	ND	ND	0/18	NA
Vanadium	ND	ND	0/19	NA	3.1	3.9	2/18	1-GW12
Zinc	3.9	19.5	11/19	1-GW12	ND	ND	0/18	NA

Notes: Groundwater concentrations are presented in µg/L (ppb)
 J - Estimated
 NA - Not applicable
 ND - Not detected

SECTION 5.0 FIGURES

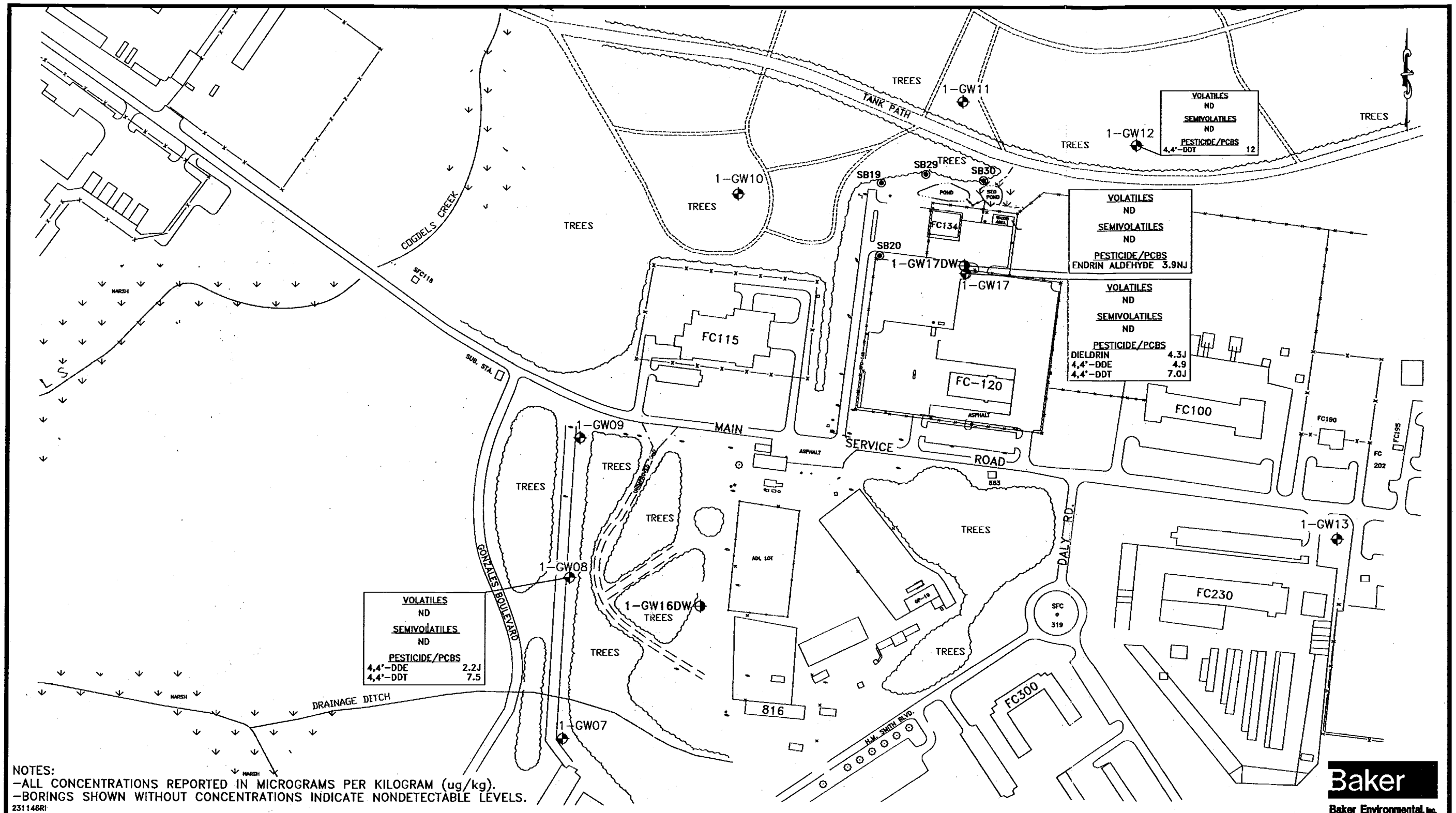

NOTES:
 -ALL CONCENTRATIONS REPORTED IN MICROGRAMS PER KILOGRAM (ug/kg).
 -BORINGS SHOWN WITHOUT CONCENTRATIONS INDICATE NONDETECTABLE LEVELS.
 231146R1

Baker
 Baker Environmental, Inc.

LEGEND

<p>1-GW07 ●</p> <p>1-GW16DW ●</p> <p>SB17 ●</p>	<p>PILOT TEST BORING FOR SHALLOW MONITORING WELL</p> <p>PILOT TEST BORING FOR DEEP MONITORING WELL</p> <p>SOIL BORING LOCATION</p>
---	--

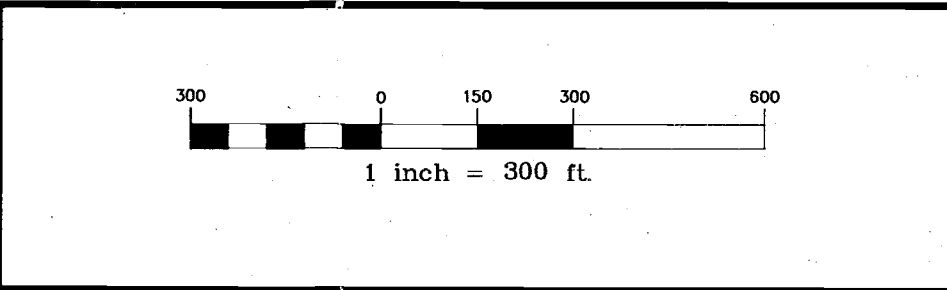
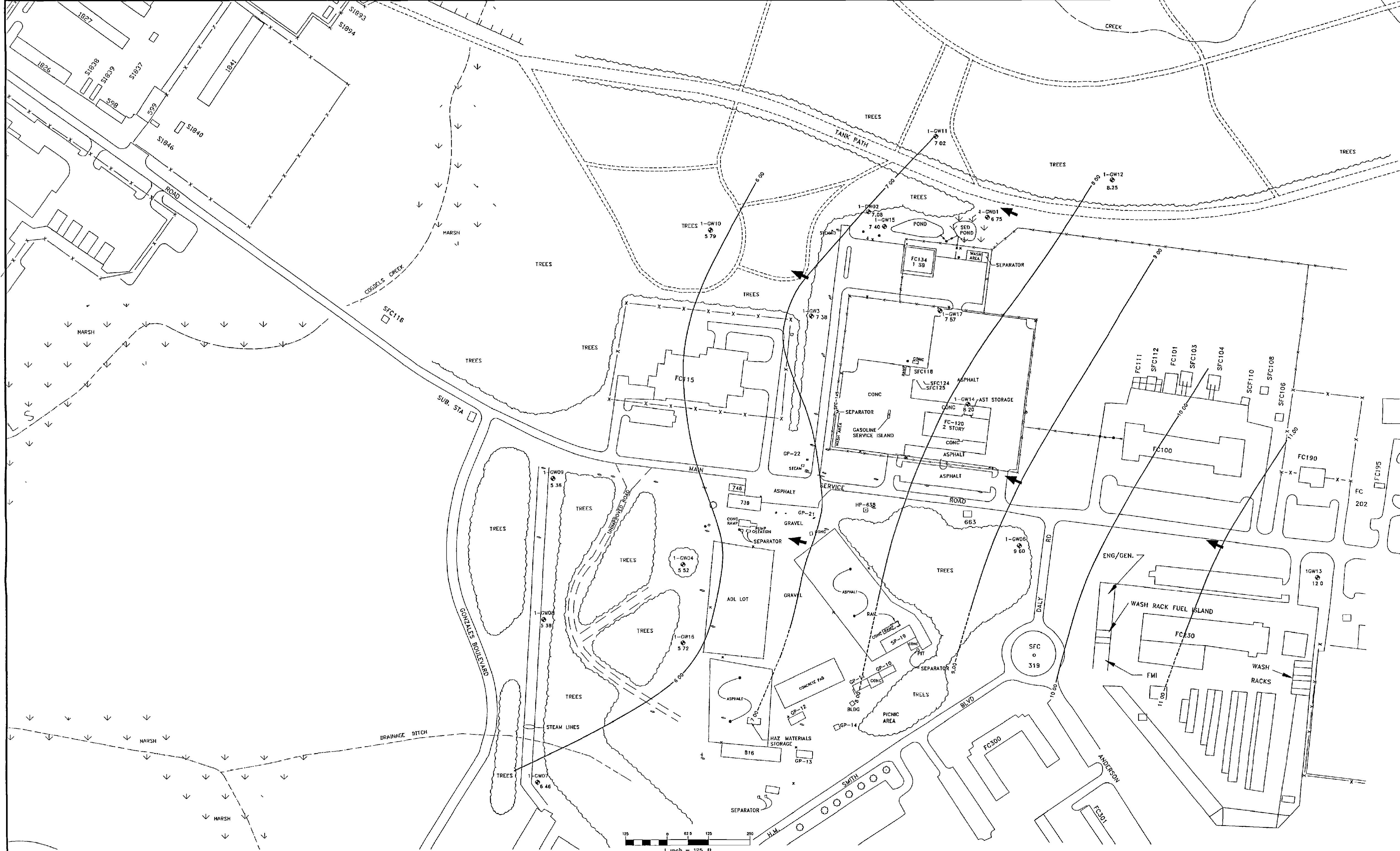

FIGURE 5-1
 POSITIVE DETECTIONS OF ORGANIC COMPOUNDS IN SURFACE SOILS
 SITE 1 - FRENCH CREEK LIQUIDS DISPOSAL AREA
 REMEDIAL INVESTIGATION CTO-0231
 MARINE CORPS BASE, CAMP LEJEUNE
 NORTH CAROLINA

SOURCE: LANTDIV, FEBRUARY 1992 AND W.K. DICKSON & ASSOC., JUNE 1994

014990182



1 inch = 125 ft

LEGEND
 HP-638 WATER SUPPLY WELL
 1-GW01 EXISTING SHALLOW MONITORING WELL
 -5.00- GROUNDWATER ELEVATION CONTOUR LINE, FEET ABOVE MSL
 APPROXIMATE GROUNDWATER FLOW DIRECTION
 6.75 GROUNDWATER ELEVATION (WELL SPECIFIC), FEET ABOVE MSL
 NOTE: GROUNDWATER ELEVATION DATA FROM MONITORING WELL 1-GW01 WAS NOT USED FOR GENERATING CONTOUR MAP (SEE TEXT)
 SOURCE LANTDIV, FEBRUARY 1992

DATE JANUARY 1995
 SCALE 1" = 125'
 DRAWN REL
 REVIEWED TFT
 S O # 62470-231-0000
 CADD# 231125R1

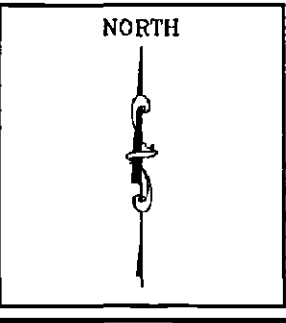

REMEDIAL INVESTIGATION CTO-0231
 MARINE CORPS BASE, CAMP LEJEUNE
 NORTH CAROLINA

BAKER ENVIRONMENTAL, Inc.
 Coraopolis, Pennsylvania

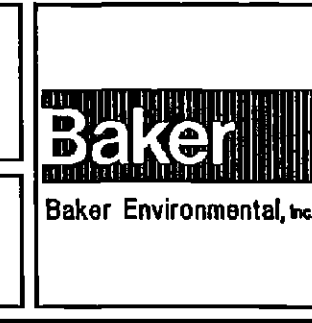

GROUNDWATER CONTOUR MAP FOR THE
 SURFICIAL AQUIFER - MAY 9, 1994
 SITE 1 - FRENCH CREEK
 LIQUIDS DISPOSAL AREA

SCALE 1" = 125'
 DATE JANUARY 1995

FIGURE No
 4-7

01427019X

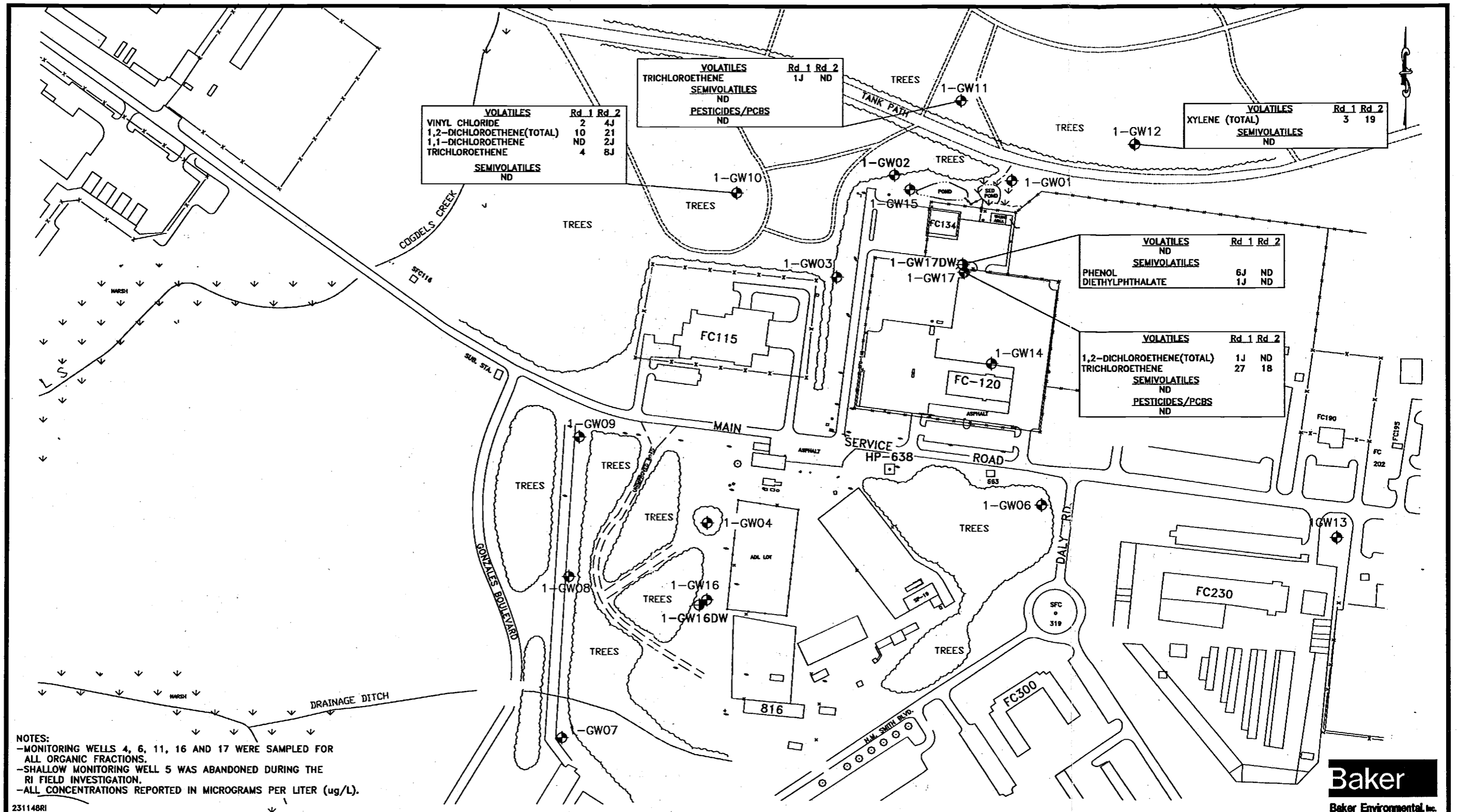

NOTES:
 -MONITORING WELLS 4, 6, 11, 16 AND 17 WERE SAMPLED FOR ALL ORGANIC FRACTIONS.
 -SHALLOW MONITORING WELL 5 WAS ABANDONED DURING THE RI FIELD INVESTIGATION.
 -ALL CONCENTRATIONS REPORTED IN MICROGRAMS PER LITER (ug/L).

231148RI

LEGEND

- 1-GW07 SHALLOW MONITORING WELL
- 1-GW16DW DEEP MONITORING WELL
- HP-638 WATER SUPPLY WELL

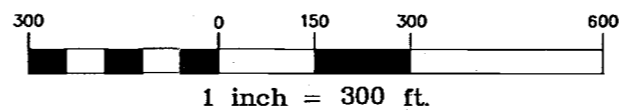

FIGURE 5-3
 POSITIVE DETECTIONS OF ORGANIC COMPOUNDS
 IN SHALLOW AND DEEP GROUNDWATER
 SITE 1 - FRENCH CREEK LIQUIDS DISPOSAL AREA
 REMEDIAL INVESTIGATION CTO-0231
 MARINE CORPS BASE, CAMP LEJEUNE
 NORTH CAROLINA

SOURCE: LANTDIV, FEBRUARY 1992 AND W.K. DICKSON & ASSOC., JUNE 1994

01499U20Z

6.0 CONTAMINANT FATE AND TRANSPORT

The potential for a contaminant to migrate and persist in an environmental medium is critical when evaluating the potential for a chemical to elicit an adverse human health or ecological effect. The environmental mobility of a chemical is influenced by its physical and chemical properties, the physical characteristics of the site, and the site chemistry. This section presents a discussion of the various physical and chemical properties of contaminants detected at Site 1 of OU No.7 and their fate and transport through the environment.

6.1 Chemical and Physical Properties Impacting Fate and Transport

Table 6-1 presents the physical and chemical properties associated with the organic contaminants detected during this investigation. These properties determine the inherent environmental mobility and fate of a contaminant. These properties include:

- Vapor pressure
- Water solubility
- Octanol/water partition coefficient
- Organic carbon adsorption coefficient (sediment partition)
- Specific gravity
- Henry's Law constant
- Mobility index

A discussion of the environmental significance of each of these properties follows.

Vapor pressure provides an indication of the rate at which a chemical may volatilize. It is of primary significance at environmental interfaces such as surface soil/air and surface water/air. Volatilization can be important when evaluating groundwater and subsurface soils, particularly when selecting remedial technologies. Vapor pressure for monocyclic aromatics are generally higher than vapor pressures for PAHs. Contaminants with higher vapor pressures (e.g., volatile organic compounds [VOCs]) will enter the atmosphere at a quicker rate than the contaminants with low vapor pressures (e.g., inorganics).

The rate at which a contaminant is leached from soil by infiltrating precipitation is proportional to its water solubility. More soluble contaminants (e.g., VOCs) are usually more readily leached than less soluble contaminants (e.g., inorganics). The water solubilities indicate that the volatile organic contaminants including monocyclic aromatics are usually several orders-of-magnitude more soluble than PAHs. Consequently, highly soluble compounds such as the chlorinated VOCs will migrate at a faster rate than less water soluble compounds.

The octanol/water partition coefficient (K_{ow}) is the ratio of the chemical concentration in octanol divided by the concentration in water. The octanol/water partition coefficient has been shown to correlate well with bioconcentration factors in aquatic organisms and adsorption to soil or sediment. Specifically, a linear relationship between octanol/water partition coefficient and the uptake of chemicals by fatty tissues of animal and human receptors (the bioconcentration factor - BCF) has been established (Lyman et al., 1982). The coefficient is also useful in characterizing the sorption of compounds by organic soils where experimental values are not available.

The organic carbon adsorption coefficient (K_{oc}) indicates the tendency of a chemical to adhere to soil particles organic carbon. The solubility of a chemical in water is inversely proportional to the K_{oc} . Contaminants with high soil/sediment adsorption coefficients generally have low water solubilities. For example, contaminants such as PAHs are relatively immobile in the environment and are preferentially bound to the soil. These compounds are not subject to aqueous transport to the extent of compounds with higher water solubilities. Erosional properties of surface soils may, however, enhance the mobility of these bound soils contaminants.

Specific gravity is the ratio of a given volume of pure chemical at a specified temperature to the weight of the same volume of water at a given temperature. Its primary use is to determine whether a contaminant will have a tendency to "float" or "sink" (as an immiscible liquid) in water if it exceeds its corresponding water solubility.

Vapor pressure and water solubility are of use in determining volatilization rates from surface water bodies and from groundwater. These two parameters can be used to estimate an equilibrium concentration of a contaminant in the water phase and in the air directly above the water. This can be expressed as Henry's Law Constant.

A quantitative assessment of mobility has been developed that uses water solubility (S), vapor pressure (VP), and organic carbon partition coefficient (K_{oc}) (Laskowski, 1983). This value is referred to as the Mobility Index (MI). It is defined as:

$$MI = \log((S*VP)/K_{oc})$$

A scale to evaluate MI is presented by Ford and Gurba (1984):

<u>Relative MI</u>	<u>Mobility Description</u>
> 5	extremely mobile
0 to 5	very mobile
-5 to 0	slightly mobile
-10 to -5	immobile
< -10	very immobile

6.2 Contaminant Transport Pathways

Based on the evaluation of existing conditions at Site 1, the following potential contaminant transport pathways have been identified.

- On-site atmospheric deposition of windblown dust.
- Leaching of sediment contaminants to surface water.
- Migration of contaminants in surface water.
- Leaching of soil contaminants to groundwater.
- Migration of groundwater contaminants off site.
- Groundwater infiltration from the shallow aquifer to the deep aquifer.

Contaminants released to the environment could also undergo the following during transportation:

- Physical transformations: volatilization, precipitation
- Chemical transformations: photolysis, hydrolysis, oxidation, reduction
- Biological transformation: biodegradation
- Accumulation in one or more media

The following paragraphs describe the potential transport pathways listed above.

6.2.1 On-Site Deposition of Windblown Dust

Wind can act as a contaminant transport pathway agent by eroding exposed soil and exposed sediment and blowing it off site. This is influenced by: wind velocity, the grain size/density of the soil/sediment particles and the amount of vegetative cover over the soil or sediment.

A majority of the surface area of Site 1 is a mixture of gravel and concrete. Consequently, there is some potential for fugitive dust generation.

6.2.2 Leaching of Sediment Contaminants to Surface Water

When in contact with surface water, contaminants attached to sediment particles can disassociate from the sediment particle into surface water. This is primarily influenced by the physical and chemical properties of the contaminant, (i.e., water solubility, K_{oc}) and the physical and chemical properties of the sediment particle (i.e., grain size, f_{oc}).

At Site 1, there were no surface water bodies of concern. Surface water and sediment samples were collected from an on-site drainage ditch. However, this drainage ditch does not constitute a surface water body of concern.

6.2.3 Leaching of Soil Contaminants to Groundwater

Contaminants that adhere to soil particles or have accumulated in soil pore spaces can leach and migrate vertically to the groundwater due to precipitation. The rate and extent of this migration is influenced by the depth to the water table, amount of precipitation, rate of infiltration, the physical and chemical properties of the soil, and the physical and chemical properties of the contaminant.

Groundwater samples were collected from shallow and deep monitoring wells at Site 1. The groundwater analytical results can be compared to soil sample analytical results to determine if contaminants detected in soil have migrated or may migrate in the future, to underlying groundwater. These results were discussed in detail in Section 5.0, Nature and Extent of Contamination.

6.2.4 Migration of Groundwater Contaminants

Contaminants leaching from soils to underlying groundwater can migrate as dissolved constituents in groundwater in the direction of groundwater flow. Three general processes govern the migration of dissolved contaminants caused by the flow of water: (1) advection, movement caused by flow of groundwater; (2) dispersion, movement caused by irregular mixing of waters during advection; and (3) retardation, principally chemical mechanisms which occur during advection. Subsurface

transport of the immiscible contaminants is governed by a set of factors different from those of dissolved contaminants.

Advection is the process which most strongly influences the migration of dissolved organic solutes. Groundwater, under water table aquifer conditions (i.e., unconfined aquifer), generally flows from regions of the subsurface where the water table is under a higher head (i.e., recharge areas) to regions of where the water table is under a lower head (i.e., discharge areas). Hydraulic gradient is the term used to describe the magnitude of this force (i.e., the slope of the water table). The gradient typically follows the topography for shallow, uniform sandy aquifers which are commonly found in coastal regions. In general, groundwater flow velocities, in sandy aquifers, under natural gradient conditions are probably between 32.8 feet/year to 328 feet/year (10 meters/year to 100 meters/year) (Lyman, et al., 1982).

The average seepage velocity of groundwater flow at Site 1 for both the shallow and deep water-bearing zones can be estimated by using a variation of Darcy's equation:

$$V_x = (K \cdot i) / N_e$$

where,

- V_x = average seepage velocity
- K = hydraulic conductivity (cm/sec)
- i = hydraulic gradient
- N_e = effective porosity

For the shallow lithology at Site 1 of OU No.7, the hydraulic conductivity (K) was estimated at 3.3 ft/day (O'Brien & Gere, 1990). The average calculated groundwater gradient was 0.0027. An estimated effective porosity of 0.3 was used for silty-sands (Fetter, 1980). This resulted in an estimated groundwater flow velocity is 0.029 ft/day or 10 ft/yr.

Based on soil lithology information obtained during the test borings and groundwater elevation data, there are two aquifer systems underlying OU No. 7. The aquifers are separated by a thin semi-confining layer (typically less than three feet) of sandy-clay. Although the semi-confining layer exists, there is vertical groundwater movement between the aquifers. Data obtained from a pump test performed within Hadnot Point (ESE, 1988) indicated a hydraulic conductivity (or leakage characteristic) ranging from 1.4×10^{-3} ft/day (4.9×10^{-7} cm/sec) to 5.1×10^{-2} ft/day (1.8×10^{-5} cm/sec) for the semi-confining clayey interval. This range of values suggests that the clayey interval has a high enough permeability to permit vertical movement of groundwater between the aquifers. Accordingly, contaminants introduced in the shallow soils over time could migrate vertically from the surficial to the Castle Hayne aquifer.

Dispersion results from two basic processes, molecular diffusion and mechanical mixing. The kinetic activity of dissolved solutes results in diffusion of solutes from a zone of high concentration to a lower concentration. Dispersion and spreading during transport result in the dilution of contaminants (maximum concentration of contaminant decreases with distance from the source). For simple hydrogeological systems, the spreading is reported to be proportional to the flow rate. Spreading is largely scale dependent. Furthermore, dispersion in the direction of flow is often observed to be markedly greater than dispersion in the directions transverse (perpendicular) to the flow. Because detailed studies to determine dispersive characteristics at the site were not conducted,

longitudinal and transverse dispersivities are estimated based on similar hydrogeological systems (Mackay, et al., 1985).

Some dissolved contaminants may interact with the aquifer solids encountered along the flow path through adsorption, partitioning, ion exchange, and other processes. The interactions result in the contaminant distribution between aqueous phase and aquifer solids, diminution of concentrations in the aqueous phase, and retardation of the movement of the contaminant relative to groundwater flow. The higher the fraction of the contaminant sorbed, the more retarded its transport. Certain halogenated organic solvents sorption is affected by hydrophobicity (antipathy for dissolving in water) and the fraction of solid organic matter in the aquifer solids (organic carbon content). If the aquifer is homogeneous, sorption of hydrophobic organic solute should be constant in space and time. If the sorptive interaction is at equilibrium and completely reversible, the solute should move at a constant average velocity equal to the groundwaters average velocity divided by the retardation factor.

Organic contaminants can be transformed into other organic compounds by a complex set of chemical and biological mechanisms. The principal classes of chemical reactions that can affect organic contaminants in water are hydrolysis and oxidation. However, it is believed that most chemical reactions occurring in the groundwater zone are likely to be slow compared with transformations mediated by microorganisms. Certain organic groundwater contaminants can be biologically transformed by microorganisms attached to solid surfaces within the aquifer. Factors which affect the rates of biotransformation of organic compounds include: water temperature and pH, the number of species of microorganisms present, the concentration of substrate, and presence of microbial toxicants and nutrients, and the availability of electron acceptors. Transformation of a toxic organic solute is no assurance that it has been converted to harmless or even less harmful hazardous products. Biotransformation of common groundwater contaminants, such as TCE, TCA, and PCE, can result in the formation of such intermediates as vinyl chloride (Mackay, et al., 1985).

The interaction of non-ionic organic compounds with solid phases can also be used to predict the fate of the highly nonpolar organic contaminants (i.e., 4,4'-DDT, PCBs). Sorptive binding is proportional to the organic content of the sorbent. Sorption of non-ionic organic pesticides can be attributed to an active fraction of the soil organic matter (Lyman et al., 1982). The uptake of neutral organics by soils results from their partitioning to the solutes aqueous solubility and to its liquid-liquid (e.g., octanol-water) partition coefficient (Chiou, 1979). Currently, literature information is available on the interrelation of soil organic properties to the binding of pesticides, herbicides, and high molecular weight pollutants such as PCBs. Organic matrices in natural systems that have varying origins, degrees of humification, and degrees of association with inorganic matrices exhibit dissimilarities in their ability to sorb non-ionic organic contaminants.

The soils and sediments formed or deposited on the land surface can act as a reservoir for inorganic contaminants. Soils contain surface-active mineral and humic constituents involved in reactions that affect metal retention. The surfaces of fine-grained soil particles are very chemically active. The surface soils can be negatively charged, positively charged or electronically neutral.

Opposite charged metallic counterions from solutions in soils (i.e., groundwater) are attracted to these charged surfaces. The relative proportions of ions attracted to these various sites depends on the degree of acidity or alkalinity of the soil, on its mineralogical composition, and on its content of organic matter. The extent of adsorption depends on either the respective charges on the adsorbing surface and the metallic cation.

In addition to these adsorption reactions, precipitation of new mineral phases also may occur if the chemical composition of the soil solution becomes supersaturated with respect to the insoluble precipitates. Of the probable precipitates, the most important of these phases are hydroxides, carbonates, and sulfides. The precipitation of hydroxide minerals is important for metals such as iron and aluminum, the precipitation of carbonate minerals is significant for calcium and barium, and the precipitation of sulfide minerals dominates the soil chemistry of zinc, cadmium, and mercury. A number of precipitates may form if metals are added to soils the concentration of metal in solution will be controlled, at equilibrium, by the solid phase that results in the lowest value of the activity of the metallic ion in solution (Evans, 1989).

Table 6-2 presents the general processes which influence the aquatic fate of contaminants at Site 1.

The following paragraphs summarize the site-specific fate and transport data for some contaminants of potential concern at Site 1.

6.3 Fate and Transport Summary

The following paragraphs summarize the contaminant group fate and transport data for contaminants detected in media collected at Site 1.

6.3.1 Volatile Organic Compounds

VOCs (i.e., vinyl chloride, TCE, and PCE) tend to be mobile in environmental media as indicated by their presence in groundwater and their corresponding MI values. Their environmental mobility is a function of high water solubilities, high vapor pressures, low K_{ow} and K_{oc} values, and high mobility indices.

In surface media, VOCs will readily volatilize into the atmosphere. Because VOCs are highly mobile in soil, they will leach to underlying groundwater, but will not partition significantly from the water column to sediment. In natural water and soil systems, VOCs will be slowly biodegraded. Consequently, in subsurface environments, VOCs will tend to persist. Hydrolysis, oxidation and direct photolysis are not important fate processes for VOCs in water.

At Site 1, VOCs were found infrequently in the subsurface soils and to a certain degree in the shallow groundwater. It is expected that the VOCs found in these media will biodegrade slowly over time. Rapid biodegradation VOCs in these media would require appropriate conditions and adaptation.

6.3.2 Polynuclear Aromatic Hydrocarbons

Low water solubilities, high K_{ow} and K_{oc} indicate a strong tendency for PAHs to adsorb to soils. Of the PAHs, fluoranthene, is probably the best marker compound, since it is consistently the most abundant of the PAHs measured and provides the strongest correlation with total PAH values. Benzo(ghi) perylene is usually the most abundant compound in soils with low PAH values but becomes less important with increasing total PAH values. Other PAHs are benzo(a)anthracene, chrysene, pyrene, benzo(ghi) perylene, benzo(b)fluoranthene and phenanthrene. Their mobility indices indicate that they are relatively immobile from a physical-chemical standpoint. An exception is naphthalene, which is considered only slightly immobile because of somewhat higher water solubility (Jones, et al., 1989).

PAHs generally lack adequate vapor pressures to be transmitted via vaporization and subsequent airborne transport. However, surface and shallow surface soil particles containing PAHs could potentially be subject to airborne transport and subsequent deposition, especially during mechanical disturbances such as vehicle traffic or digging (Jones, et al., 1989).

PAHs are somewhat persistent in the environment. In general their persistence increases with increasing ring numbers. Photolysis and oxidation may be important removal mechanisms in surface waters and surficial soils, while biodegradation could be an important fate process in groundwater, surface soils or deeper soils. PAHs are ubiquitous in nature. The presence of PAHs in the soil may be the result of aerielly deposited material, and the chemical and biological conditions in the soil which result in selective microbial degradation/breakdown.

6.3.3 Pesticides/Polychlorinated Biphenyls

Pesticides/PCBs are persistent and immobile contaminants in environmental media. Pesticides travel at varying rates through soil, mainly due to their affinity for soil surfaces. The soil sorption coefficient (K_d) is the distribution of a pesticide between soil and water. In general, the K_d values are higher for high organic carbon soil than for low organic carbon soils. Therefore, soils with high K_d values will retain pesticides (i.e., 4,4'-DDT, 4,4'-DDE, and 4,4'-DDD). As evidenced by the ubiquitous nature of 4,4'-DDT, 4,4'-DDE, and 4,4'-DDD, volatilization is an important transport process from soils and waters.

PCBs have low vapor pressures, low water solubilities, and high K_{oc} and K_{ow} values. Adsorption of these contaminants to soil and sediment is the major fate of these contaminants in the environment.

6.3.4 Inorganics

Inorganics can be found as solid complexes at ambient temperature and pressure in soils at the site. Inorganic ions exist in pure solutions as hydrated ions. Groundwater, as opposed to a pure solution, is a highly complex chemical system which is heavily influenced by the mineralogy of the substrate. Factors affecting the transport of inorganics in saturated soils are interactive and far more complex and numerous than those affecting the transport of organic contaminants.

The most complicated pathway for inorganic contaminants is migration in subsurface soils and groundwaters, where oxidation reduction potential (Eh) and pH play critical roles. Table 6-3 presents an assessment of relative inorganic environmental mobilities as a function of Eh and pH. Soils at MCB Camp Lejeune are relatively neutral, therefore, inorganics in the subsurface soil should be relatively immobile.

Transport of inorganic species in groundwater is mainly a function of the inorganic's solubility in solution under the chemical conditions of the soil-solution matrix. The inorganic must be dissolved (i.e. in solution) for leaching and transport by advection with the groundwater to occur. Generally, dynamic and reversible processes control solubility and transport of the dissolved metal ions. Such process include precipitation/dissolution, adsorption/desorption, and ion exchange.

Inorganics could be sorbed onto colloidal materials, theoretically increasing their inherent mobility in saturated porous media. It is important to note, however, that colloids themselves are not mobile in most soil/water systems.

Inorganics such as arsenic and chromium depend upon speciation to influence their mobility. Speciation varies with the chemistry of the environmental medium and temporal factors. These variables make the site-specific mobility of an inorganic constituent difficult to assess.

SECTION 6.0 TABLES

TABLE 6-1

ORGANIC PHYSICAL AND CHEMICAL PROPERTIES
 SITE 1, FRENCH CREEK LIQUIDS DISPOSAL AREA
 REMEDIAL INVESTIGATION, CTO-0231
 MCB, CAMP LEJEUNE, NORTH CAROLINA

COPCs	Vapor Pressure (mm Hg)	Water Solubility (mg/L)	Log Kow	Log Koc	Specific Gravity (g/cm ³)	Henry's Law Constant (atm-m ³ /mole)	Mobility Index	Comments
VOLATILES								
1,2-Dichloroethene	200	600	1.48	2.26	1.22	1.90E-01	3.00	Very Mobile
Trichloroethene	60	1100	2.29	2.09	1.46	1.17E-03	2.70	Very Mobile
SEMIVOLATILES								
Bis(2-ethylhexyl)phthalate	6.45E-06	0.3	5.11	4.5	NA	1.1E-05	NA	NA
PESTICIDES								
4,4'-DDD	1.0E-06	0.09	5.99	4.47	NA	2.20E-08	-12.00	Very Immobile
4,4'-DDE	6.5E-06	0.04	4.28	3.66	NA	6.80E-05	-10.00	Immobile

NA = Not Available

References:

- Howard, 1989-1991
- Montgomery, 1990
- Sax and Lewis, 1987
- SCDM, 1991
- USEPA, 1986
- USEPA, 1986a
- Verscheuren, 1983

TABLE 6-2

PROCESSES INFLUENCING FATE OF ORGANIC POLLUTANTS
SITE 1, FRENCH CREEK LIQUIDS DISPOSAL AREA
REMEDIAL INVESTIGATION, CTO-0231
MCB, CAMP LEJEUNE, NORTH CAROLINA

Contaminant	Processes					
	Sorption	Volatilization	Biodegradation	Photolysis-Direct	Hydrolysis	Bioaccumulation
<i>Pesticides/PCBs</i>						
Aldrin	+	+	?	-	-	+
Chlordane	+	+	?	-	-	+
DDD	+	+	-	-	-	+
DDE	+	+	-	+	-	+
DDT	+	+	-	-	+	+
Dieldrin	+	+	-	+	-	+
Endosulfan and Endosulfan Sulfate	+	+	+	?	+	-
Endrin and Endrin Aldehyde	?	?	?	+	-	+
Heptachlor	+	+	-	?	++	+
Heptachlor Epoxide	+	-	?	?	-	+
<i>PCBs</i>	+	+	+ ⁽¹⁾	?	-	+
<i>Halogenated Aliphatic Hydrocarbons</i>						
Chloromethane (methyl chloride)	-	+	-	-	-	-
Dichloromethane (methylene chloride)	-	+	?	-	-	-
1,1-Dichloroethane (ethylidene chloride)	-	+	?	-	-	-
1,2-Dichloroethane (ethylene dichloride)	-	+	?	-	-	-
1,1,2-Trichloroethane	?	+	-	-	-	?
Chloroethene (vinyl chloride)	+	-	-	-	-	-
1,1,-Dichloroethene (vinylidene chloride)	?	+	?	-	-	?
Trichloroethene	-	+	?	-	-	-
Tetrachloroethene (perchloroethylene)	-	+	+	-	-	-

TABLE 6-2 (Continued)

**PROCESSES INFLUENCING FATE OF ORGANIC POLLUTANTS
SITE 1, FRENCH CREEK LIQUIDS DISPOSAL AREA
REMEDIAL INVESTIGATION, CTO-0231
MCB, CAMP LEJEUNE, NORTH CAROLINA**

Contaminant	Processes					
	Sorption	Volatilization	Biodegradation	Photolysis-Direct	Hydrolysis	Bioaccumulation
Bromodichloromethane	?	?	?	?	-	+
Dichlorodifluoromethane	?	+	-	?	-	?
<i>Monocyclic Aromatics</i>						
Benzene	+	+	-	-	-	-
Ethylbenzene	?	+	?	-	-	-
Toluene	+	+	?	-	-	-
Phenol	-	+	+	-	-	-
2,4-Dimethyl phenol (2,4-xyleneol)	-	-	?	+	-	-
<i>Phthalate Esters</i>						
Dimethyl phthalate	+	-	+	-	-	+
Diethyl phthalate	+	-	+	-	-	+
Di-n-butyl phthalate	+	-	+	-	-	+
Di-n-octyl phthalate	+	-	+	-	-	+
Bis (2-ethylhexyl) phthalate	+	-	+	-	-	+
Butyl benzyl phthalate	+	-	+	-	-	+
<i>Polycyclic Aromatic Hydrocarbons</i>						
Acenaphthene ⁽³⁾	+	-	+	+	-	-
Accenaphthylene ⁽³⁾	+	-	+	+	-	-
Fluorene ⁽³⁾	+	-	+	+	-	-
Naphthalene	+	-	+	+	-	-
Anthracene	+	+	+	+	-	-
Fluoranthene ⁽³⁾	+	+	+	+	-	-

TABLE 6-2 (Continued)

PROCESSES INFLUENCING FATE OF ORGANIC POLLUTANTS
 SITE 1, FRENCH CREEK LIQUIDS DISPOSAL AREA
 REMEDIAL INVESTIGATION, CTO-0231
 MCB, CAMP LEJEUNE, NORTH CAROLINA

Contaminant	Processes					
	Sorption	Volatilization	Biodegradation	Photolysis-Direct	Hydrolysis	Bioaccumulation
Phenanthrene ⁽³⁾	+	+	+	+	-	-
Benzo(a)anthracene	+	+	+	+	-	-
Benzo(b)fluoranthene ⁽³⁾	+	-	+	+	-	-
Benzo(k)fluoranthene ⁽³⁾	+	-	+	+	-	-
Chrysene ⁽³⁾	+	-	+	+	-	-
Pyrene ⁽³⁾	+	-	+	+	-	-
Benzo(g,h,i)perylene ⁽³⁾	+	-	+	+	-	-
Benzo(a)pyrene	+	+	+	+	-	-
Dibenzo(a,h)anthracene ⁽³⁾	+	-	+	+	-	-
Ideno(1,2,3-cd)pyrene ⁽³⁾	+	-	+	+	-	-

- ++ Predominate fate determining process
- + Could be an important fate process
- Not Likely to be an important process
- ? Importance of process uncertain or not known

Notes: ⁽¹⁾ Biodegradation is the only process known to transform polychlorinated biphenyls under environmental conditions, and only the lighter compounds are measurably biodegraded. There is experimental evidence that the heavier polychlorinated biphenyls (five chlorine atoms or more per molecule) can be photolyzed by ultraviolet light, but there are no data to indicate that this process is operative in the environment.

⁽²⁾ Based on information for 4-nitrophenol.

⁽³⁾ Based on information for PAHs as a group. Little or no information for these compounds exists.

Source: USEPA. 1985. Water Quality Assessment: A Screening Procedure for Toxic and Conventional Pollutants in Surface and Groundwater - Part I.

TABLE 6-3

RELATIVE MOBILITIES OF INORGANICS AS A FUNCTION OF ENVIRONMENTAL CONDITIONS
 (Eh, pH)
 SITE 1, FRENCH CREEK LIQUIDS DISPOSAL AREA
 REMEDIAL INVESTIGATION, CTO-0231
 MCB, CAMP LEJEUNE, NORTH CAROLINA

Relative Mobility	Environmental Conditions			
	Oxidizing	Acidic	Neutral/ Alkaline	Reducing
Very high			Se	
High	Se, Zn	Se, Zn, Cu, Ni, Hg, Ag		
Medium	Cu, Ni, Hg, Ag, As, Cd	As, Cd	As, Cd	
Low	Pb, Ba, Se	Pb, Ba, Be	Pb, Ba, Be	
Very Low	Fe, Cr	Cr	Cr, Zn, Cu, Ni, Hg, Ag	Cr, Se, Zn, Cu, Ni, Hg, Pb, Ba, Be, Ag

Notes:

Se = Selenium	Cd = Cadmium
Zn = Zinc	Ba = Barium
Cu = Copper	Pb = Lead
Ni = Nickel	Fe = Iron
Hg = Mercury	Cr = Chromium
Ag = Silver	Be = Beryllium
As = Arsenic	Zn = Zinc

Source: Swartzbaugh, et al. "Remediating Sites Contaminated with Heavy Metals."
 Hazardous Materials Control, November/December 1992.

7.0 BASELINE HUMAN HEALTH RISK ASSESSMENT

The following subsections present the baseline human health risk assessment (BRA) conducted for Site 1, the French Creek Liquids Disposal Area. This assessment was performed in accordance with the USEPA document Risk Assessment Guidance for Superfund, Human Health Evaluation Manual: Part A (USEPA, 1989). The purpose of the BRA is to assess whether the contaminants of potential concern (COPCs) at the site pose a current or future risk to human health in the absence of remedial action. COPCs are site-related contaminants used to quantitatively estimate human exposures and associated potential health effects. Because the purpose of the risk assessment is to estimate the degree of risk to human health and to be protective of human health, the approach of the USEPA guidance is designed to be conservative. This protectiveness is achieved by the use of assumptions and models that result in upper bound estimates of risk, i.e., the true or actual risk is expected to fall between the estimated value and zero. As a result, the actual site risks are unlikely to exceed the estimated upper bound values and are probably lower. The following paragraphs present a brief overview of the risk assessment process and how the assessment affects further activity at the sites.

For the BRA, both current and future land use exposure scenarios were assumed for the site. The current scenario reflects potential human exposure pathways to the COPCs that presently exist at the site (i.e., exposure pathways currently available). Likewise, the future use scenario represents exposure pathways that are conceivable in the future (e.g., residential development). The future use is typically determined by zoning and the environmental setting of the site. The development of current and future use exposure scenarios is consistent with the methodology for baseline risk assessment, as specified by USEPA.

The National Contingency Plan (NCP) stipulates a range of acceptable cancer risk levels of 1×10^{-4} to 1×10^{-6} for total risk at a hazardous waste site (USEPA, 1990). These cancer risk levels represent the probability of an individual developing cancer over his or her lifetime if exposed to the COPCs at the site. For example, a risk level of 10^{-6} is the probability that one person in 1,000,000 exposed persons will develop cancer in a lifetime. The total noncarcinogenic acceptable risk level is a hazard index of less than or equal to 1.0. This noncancer risk level depicts a level at or below which adverse systemic effects are not expected in the exposed population.

A remedial action is recommended when either the total cancer or noncancer risks are above the criteria established by the NCP. Some form of remedial action also is necessary when either the current or future exposure point concentrations at the site are above the applicable or suitable analogous standards (e.g., maximum contaminant levels [MCLs] for drinking water) for those COPCs for which standards exist. When a remedial action is necessary, applicable or relevant and appropriate requirements (ARARs) and/or risk-based cleanup levels are used in determining acceptable concentrations in the environmental media. No remedial response is required when the cancer and noncancer criteria and the ARARs are not exceeded.

7.1 Introduction

The BRA investigates the potential for COPCs to affect human health and/or the environment, both now and in the future, under a "no further remedial action scenario." The BRA process evaluates the data generated during the sampling and analytical phase of the RI, identifying areas of interest and contaminants of concern with respect to geographical, demographic, and physical and biological characteristics of the study area. These, combined with the current understanding of physical and chemical properties of the site-associated constituents (with respect to environmental fate and

transport processes), are then used to estimate the concentrations of contaminants at the end points of logical exposure pathways. Finally, contaminant intakes by hypothetical receptors are determined and combined with the toxicological properties of the contaminants to estimate (inferentially) the potential public health impacts posed by constituents detected at the site.

The BRA for this site was conducted in accordance with current USEPA Risk Assessment Guidance (USEPA, 1989 and USEPA, 1991), and USEPA Region IV Supplemental Risk Guidance (USEPA, 1992d).

The components of the BRA include the following:

- Hazard Identification: determination as to whether a substance has the potential to elicit an adverse effect (toxicity) upon exposure to humans
- Exposure Assessment: identification of the human population(s) likely to be exposed and the development of specific exposure pathways for the population(s)
- Toxicity Assessment: quantification of the relationship between the human exposure and the probability of occurrence (risk) of a toxic response
- Risk Characterization: development of a quantitative estimation of the potential risk from a combination of information collected during the exposure and toxicity assessment
- Uncertainty Analysis: identification and qualitative discussion of any major sources of uncertainty pertaining to the finding of the BRA
- Conclusions: summarization and conclusion of the results of the BRA relating to the total site risk

Each of these components is discussed and addressed for the site. Introductory text is presented first, followed by a site-specific discussion. Referenced tables and figures are presented after the text portion of this section.

7.2 Hazard Identification

Data generated during the remedial investigation and previous studies at the site were used to draw conclusions and to identify data gaps in the BRA. The data were evaluated to assess which were of sufficient quality to include in the risk assessment. The objective when selecting data to include in the risk assessment was to provide accurate and precise data to characterize contamination and evaluate exposure pathways.

7.2.1 Data Evaluation and Reduction

The initial hazard identification step entailed the validation and evaluation of the site data to determine its usability in the risk assessment. This process resulted in the identification of COPCs for the site. During this validation and evaluation, data that would result in inaccurate conclusions (e.g., data that were rejected or attributed to blank contamination, as qualified by the validator) were reduced within the data set. Data reduction entailed the removal of unreliable data from the original

data set based on the guidelines established by USEPA. A summary of the data quality was presented in Section 5.1.

7.2.2 Identify Data Suitable for Use in a Quantitative Risk Assessment

To provide for accurate conclusions to be drawn from sampling results, analytical data were reviewed and evaluated. During this review and evaluation, data that would lead to inaccurate conclusions (e.g., data rejected by the validator) were reduced within each data set. This section presents the criteria that were used to review, reduce, and summarize the analytical data. These criteria are consistent with USEPA guidance for data reduction.

Three environmental media were investigated at the site during this RI: surface soils, subsurface soils and groundwater. Surface water and sediment samples were collected from a drainage ditch. The drainage ditch does not represent a classifiable surface water body used for human consumption, recreation or as an ecological habitat. Consequently, these samples were removed from the data set for risk evaluation. Evaluation of this data would provide a misrepresentation of true contaminant conditions associated with Site 1, which is the focus of this study. For Site 1, surface soil, subsurface soil, and groundwater data were assessed for potential risk to human receptors.

Information relating to the nature and extent of contamination at the site is provided in detail in Section 5.0 of this volume of the report. The discussion provided in Section 5.0 of this report also was utilized in the selection of COPCs at the site. The reduced data sets for all media of concern at the site are provided in Appendix K and L of this report.

7.2.3 Criteria Used in Selection of COPCs

This section presents the selection of COPCs used to assess risks to human health. As exemplified by the data summary tables in Appendix K and L, the number of constituents positively detected at least once during the field investigation is large. Quantifying risk for all positively identified parameters may distract from the dominant risks presented by the site. Therefore, the data set was reduced to a list of COPCs. COPCs are site-related contaminants used to quantitatively estimate human exposures and associated potential health effects.

The selection of the COPCs was based on a combination of detected concentrations; toxicity; frequency of detection; comparison to background values, including site-specific, base-wide and published ranges; and comparison of physiochemical properties, including mobility, persistence, and toxicity. In addition, historical information pertaining to past site activities was considered. USEPA guidance states that a contaminant may not be retained for quantitative evaluation in the BRA if: (1) it is detected infrequently in an environmental medium (e.g., less than 5 percent given at least 20 samples in a data set), (2) it is absent or detected at low concentrations in other media, or (3) site history does not provide evidence the contaminant to be present (USEPA, 1989). To qualitatively assess COPCs, comparisons of results to federal and state criteria and Region III Risk-Based Concentrations (RBCs) (USEPA, 1994) were used. A brief description of the selection criteria used in choosing final COPCs is presented below. A contaminant did not need to meet the criteria of these three categories in order to be retained as a COPC.

7.2.3.1 Site History

Reportedly, waste liquids, including petroleum, oil and lubricants (POL) and battery acids, were disposed at this site. The groundwater, surface water and sediment of this site were initially investigated in 1984 and 1986 by ESE; groundwater was investigated by Baker in 1993. Section 2.0 provides more details concerning previous investigations conducted at Site 1. Contaminants detected included VOCs, SVOCs, and metals. Specific constituents with elevated levels were phenol, cadmium, chromium, and trichloroethene (TCE). In 1986, surface water and sediment were sampled. Results indicated elevated levels of phenol and chromium. In 1991, soils were analyzed for chemical constituents (Baker, 1991). Elevated levels of toluene, benzo(a)pyrene, chromium, lead, nickel, and zinc were detected.

During the most recent sampling event (Baker, 1994), samples of the background surface and subsurface soil, the surface and subsurface soil from the northern and southern portions of the site, and the shallow and deep groundwater, including a potable water supply well, were collected. A second round of groundwater samples were collected using a different sampling method to reduce turbidity. A discussion of this sampling event is presented in Section 3.0 of this report. Surface water/sediment samples also were collected from a drainage ditch. No biota samples were collected at Site 1.

Although samples were collected from the northern and southern portions of the site and designated as such, they were combined for this human health risk assessment and evaluated as a single data set since both historically and presently similar operations and processes occurred at both areas. In addition, it is important to note that the data from the first round of sample collection were used to assess potential risk, with the exception of the groundwater data. Two different sampling methods were used for each round of groundwater data collection. The first round of groundwater results indicated elevated levels of metals. Therefore, a second round of groundwater data was collected for metals analysis. The second round results overall were less than the round one results. It was determined that the second round metals results were more representative of the site groundwater. Therefore, the second round metals groundwater data were used to assess risk.

7.2.3.2 Frequency of Detection

In general, constituents that were detected infrequently (e.g., equal to or less than 5 percent, when at least 20 samples of a medium are available) may be anomalies due to sampling, or analytical errors, or may simply be present in the environment due to past or current site activities. It should be noted, however, that detected constituents were individually evaluated prior to exclusion from the BRA. Physiochemical properties (i.e., fate and transport) and toxicological properties for each detected constituent were evaluated (see following sections).

7.2.3.3 Comparison to Background

Sample concentrations were compared to site-specific (i.e., twice the base-wide average concentration) background levels. Background information was available for all media of concern at the site. Groundwater results were compared to results from the upgradient wells for the site. In addition to site background levels, (as presented in a study of base-wide inorganic levels [Baker, 1994]), soil metal concentrations were compared to published background levels, as recommended by USEPA guidance (USEPA, 1989). The soil metal background ranges are typical levels found in the eastern U.S. (USGS, 1984). Soil metal concentrations within the observed range were

considered to be naturally-occurring and/or representative of background conditions. The results of this comparison are presented in Tables 7-1 through 7-4.

7.2.3.4 Physiochemical Properties

The physical and chemical properties of a contaminant are responsible for its transport in the environment. These properties, in conjunction with site conditions, determine whether a contaminant will tend to volatilize into the air from surface soils or surface waters or be transported via advection or diffusion through soils, groundwaters, and surface waters. Physical and chemical properties also describe a contaminant's tendency to adsorb onto soil/sediment particles. Environmental mobility can correspond to either an increased or decreased potential to affect human health and/or the environment.

Persistence

The persistence of a contaminant in the environment depends on factors such as the microbial content of soil and water, organic carbon content, the concentration of the contaminant, climate, and the ability of the microbes to degrade the contaminant under site conditions. In addition, chemical degradation (i.e., hydrolysis), photochemical degradation, and certain fate processes such as sorption may contribute to the elimination or retention of a particular compound in a given medium.

Toxicity

The potential toxicity of a contaminant is an important consideration when selecting COPCs for further evaluation in the human health assessment. For example the weight-of-evidence (WOE) classification should be considered in conjunction with concentrations detected at the site. Some effects considered in the selection of COPCs include carcinogenicity, mutagenicity, teratogenicity, systemic effects, and reproductive toxicity. Bioaccumulation and bioconcentration properties may affect the severity of the toxic response in an organism and/or subsequent receptors and are evaluated if relevant data exist.

Despite their inherent toxicity, certain inorganic contaminants are essential nutrients. Essential nutrients need not be considered for further consideration in the quantitative risk assessment if they are present in relatively low concentrations (i.e., below twice the average base-wide background levels or slightly elevated above naturally occurring levels) or if the contaminant is toxic at doses much higher than those which could be assimilated through exposures at the site. Due to the difficulty of determining nutrient levels that were within acceptable dietary levels, only essential nutrients present at low concentrations (i.e., only slightly elevated above background) were eliminated from the BRA. Essential nutrients, however, were included in the ecological risk evaluation.

7.2.3.5 Contaminant Concentrations in Blanks

Sample concentrations were compared quantitatively to investigation-related blank concentrations. Sample concentrations of parameters that are typical laboratory or field contaminants (i.e., acetone, 2-butanone, methylene chloride, toluene, and phthalate esters) that exceeded blank concentrations by a factor of 10 and other parameter concentrations that exceeded blank concentrations by a factor of five were considered to be site related. Parameters not meeting this criteria were considered artifacts from field or laboratory practices and treated as non-detects.

For Site 1, the following organics were found in the blanks: acetone (38 µg/L), methylene chloride (13 µg/L), 2-butanone (7 µg/L), 2-hexanone (3 µg/L), chloromethane (3 µg/L), di-n-octyl phthalate (41 µg/L) and BEHP (120 µg/L). Upon application of the 5-10 rule previously described, the blank levels for comparison were as follows: acetone (380 µg/L), methylene chloride (130 µg/L), 2-butanone (70 µg/L), 2-hexanone (30 µg/L), chloromethane (15 µg/L), di-n-octyl phthalate (410 µg/L), and BEHP (1,200 µg/L).

7.2.3.6 Federal and State Criteria and Standards

Constituents detected at each site were compared to state of North Carolina and federal criteria and standards, and/or To Be Considered levels (TBCs). These comparisons may provide some insight as to the relative potential for health impacts resulting from the site. It should be noted that COPC concentration ranges were directly compared to each standard/criteria/TBC. This comparison did not take into account the additive or synergistic effects of those constituents without criteria. Consequently, conclusions regarding potential risk posed by the site cannot be inferred from this comparison.

A brief explanation of the standards/criteria/TBCs used for the evaluation of COPCs is presented below.

North Carolina Water Quality Standards (NCWQSs) - Groundwater - NCWQSs are the maximum allowable concentrations resulting from any discharge of contaminants to the land or waters of the state, which may be tolerated without creating a threat to human health or which otherwise render the groundwater unsuitable for its intended purpose.

Maximum Contaminant Levels (MCLs) - Federal Groundwater Standards - 40 CFR 161 - MCLs are enforceable standards for public water supplies promulgated under the Safe Drinking Water Act and are designed for the protection of human health. MCLs are based on laboratory or epidemiological studies and apply to drinking water supplies consumed by a minimum of 25 persons. They are designed for prevention of human health effects associated with a lifetime exposure (70-year lifetime) of an average adult (70 kg) consuming 2 liters of water per day. MCLs also consider the technical feasibility of removing the contaminant from the public water supply.

Health Advisories (HAs) - HAs are guidelines developed by the USEPA Office of Drinking Water for nonregulated constituents in drinking water. These guidelines are designed to consider both acute and chronic toxic effects in children (assumed body weight 10 kg) who consume 1 liter of water per day or in adults (assumed body weight 70 kg) who consume 2 liters of water per day. HAs are generally available for acute (1 day), subchronic (10 days), and chronic (longer-term) exposure scenarios. These guidelines are designed to consider only threshold effects and, as such, are not used to set acceptable levels of potential human carcinogens.

Region III Risk-Based Concentrations (RBCs) - The RBCs were developed by the USEPA, Region III as benchmark concentrations for evaluating site investigation data. RBCs are not intended as stand-alone decision-making tools, but as a screening tool to be used in conjunction with other information to help in the selection of COPCs. Selecting COPCs using RBCs is accomplished by comparing the maximum concentrations of each contaminant detected in each medium to its corresponding RBC. The RBCs were developed using conservative default exposure scenarios suggested by the USEPA and the latest available toxicity indices for carcinogenic and systemic chemicals. The RBC corresponds to a Hazard Quotient of 1.0 and a lifetime cancer risk of 1×10^{-6} .

The RBCs represent protective environmental concentrations at which the USEPA would not typically take action (USEPA, Region III, 1994).

As stated previously, COPCs in all media of concern at the site were compared these criteria. The results of the standards/criteria/TBC comparison for the site are presented in Tables 7-1 through 7-4. The results are discussed in Section 7.6, Standards/Criteria/TBC Comparison Results.

7.2.4 Contaminants of Potential Concern (COPCs)

The following sections present an overview of the analytical data obtained for each medium and the subsequent retention or elimination of COPCs using the aforementioned criteria for selection of COPCs.

7.2.4.1 Surface Soil

In surface soil, the COPCs were identified as the following: aluminum, antimony, arsenic, cadmium, chromium, manganese, vanadium, zinc, 4,4'-DDE, and 4,4'-DDT. These COPCs were detected frequently and exceeded site background levels.

The following chemicals were detected in the surface soils, but were excluded from the risk evaluation because the maximum concentrations did not exceed the Region III residential soil RBCs: beryllium and dieldrin. The maximum concentration of beryllium (0.19 mg/kg) is slightly greater than the Region III residential soil RBC (0.15 mg/kg), but is less than twice the average site background level (0.22 mg/kg). Consequently, these compounds were excluded from the risk assessment.

Barium, copper, lead, and nickel were detected in the surface soil at concentrations less than two times the average base-wide background level. As a result, it was not retained as a COPC in surface soil. Bis(2-ethylhexyl)phthalate (BEHP) is a common laboratory contaminant. Although found frequently in the surface soil (10 out of 14), BEHP was found at levels below the Region III RBC in soils (industrial and residential). Consequently, it was not included as a COPC in surface soil.

Essential nutrients also were excluded. In surface soil, these analytes included calcium, iron, magnesium, potassium, and sodium.

7.2.4.2 Subsurface Soil

In subsurface soil, the following COPCs were identified: aluminum, arsenic, barium, cadmium, chromium, cobalt, copper, lead, manganese, nickel, vanadium, zinc, and BEHP. These COPCs were found frequently and, for the metals, exceeded site background levels.

The following chemicals were detected in the surface soils, but were excluded from the risk evaluation due to low frequency of detection (less than 5 percent): antimony, mercury, selenium, silver, dieldrin, 4,4'-DDE, 4,4'-DDD, endosulfan II, endrin aldehyde, alpha-chlordane, gamma-chlordane, Aroclor-1254, and Aroclor-1260. Although 4,4'-DDT was found at a frequency greater than 5 percent (7.3 percent), the maximum level found in the subsurface soil (18 ug/kg) was significantly less than the Region III residential soil RBC of 1,900 ug/kg. Consequently, it was not included as a COPC.

Silver was infrequently detected and found at concentrations below the base-wide background levels. As a result, it was not identified as a COPC in surface soil. Essential nutrients also were excluded. In subsurface soil, these chemicals included calcium, iron, magnesium, potassium, and sodium. Acetone was also detected in the subsurface soil. However, acetone is a common lab contaminant and was found at a maximum level of 410 ug/kg, which only slightly exceeds the blank level of 380 µg/L. The maximum concentration of acetone in subsurface soil (0.49 mg/kg) is significantly less than the Region III residential soil RBC (780 mg/kg). Although it exceeds the detection frequency and blank contamination frequency criteria, it is well below the RBC. Consequently, it was not included as a subsurface soil COPC.

7.2.4.3 Shallow and Deep Groundwater

The COPCs retained for the shallow and deep groundwater included the following: arsenic, barium, manganese, mercury, total 1, 2-dichloroethene (1,2-DCE), and trichloroethene (TCE). These COPCs were detected frequently and exceeded site background levels and standards/criteria/TBCs, including federal and state MCLs and RBCs for tap water. It is important to note that the VOCs were found only in the shallow groundwater. However, potential risk was evaluated based upon exposure to both the shallow and deep groundwater.

The following chemicals were detected in the shallow and deep groundwater, but were excluded from the risk evaluation due several reasons. Cobalt, lead, and vanadium were found at frequencies greater than 5 percent. However, the maximum concentration of lead found in the groundwater was less than the federal action level (i.e., 2.4 ug/L vs. 15 ug/L). The maximum concentrations of cobalt and vanadium were less than the Region III tap water RBCs (i.e., cobalt at 30 ug/L vs. 220 ug/L and vanadium at 11.4 ug/L vs. 26 ug/L). Consequently, these metals not evaluated as COPCs. Phenol and diethylphthalate were detected at a frequency slightly greater than 5 percent (i.e., 5.3 percent). The maximum concentrations of these compounds were less than the Region III tap water RBCs (i.e., phenol at 6.1 ug/L vs. 2,200 ug/L and diethylphthalate at 1.3 ug/L vs. 2,900 ug/L). Similarly, chloromethane, vinyl chloride and xylene were detected at a frequency slightly greater than 5 percent (i.e., 5.3 percent). The maximum concentrations of these compounds were less than the Region III tap water RBCs (i.e., chloromethane at 1 ug/L vs. 1.4 ug/L; xylene at 3 ug/L vs. 1,200 ug/L), with the exception of vinyl chloride, which was found at a level equal to the MCL (2 ug/L). Consequently, these compounds were not evaluated as COPCs.

Essential nutrients were excluded. In shallow and deep groundwater, these chemicals included calcium, iron, magnesium, potassium and sodium. Acetone was also found in the shallow and deep groundwater. However, acetone is a common lab contaminant and was found only once at a level below the blank level (76 µg/L versus 380 µg/L). Consequently, it was not included as a COPC. Aluminum was found at levels below the Region III RBC for tap water. It was not included as a COPC. BEHP was found in 6 out of 19 samples. However, the concentrations ranged from 1 µg/L to 30 µg/L. The maximum detected concentration only was found once at 1-GW16DW-01. The other five detections were 1 µg/L, which fall below background and laboratory blanks levels. In addition, BEHP is a common laboratory contaminant. Consequently, BEHP was not evaluated as a COPC in groundwater.

Table 7-5 presents a summary of the COPCs chosen for all media of concern for Site 1. Also included on these tables are the constituents excluded from COPC selection.

7.3 Exposure Assessment

The exposure assessment addresses each potential exposure pathway via soil (surface and subsurface), groundwater, surface water, sediment, air, and biota. To determine if human exposure via these pathways may occur in the absence of remedial action, an analysis including the identification and characterization of exposure pathways was conducted. The following four elements were examined to determine if a complete exposure pathway was present:

- 1) a source and mechanism of chemical release
- 2) an environmental transport medium
- 3) a feasible receptor exposure route
- 4) a receptor exposure point

The exposure scenarios presented in the following sections are used to estimate individual risks. Unless otherwise noted, all the statistical data associated with the factors used in the dose evaluation equations for assessing exposure were obtained from the Exposure Factors Handbook (USEPA, 1989b) and the accompanying guidance manuals. A reasonable maximum exposure (RME) scenario was utilized in this assessment, which is consistent with USEPA Region IV recommendations regarding human health risk assessment. As a result, the exposure scenarios presented include RME assumptions for the input parameters in the dose evaluation equations. These values are summarized in Table 7-6.

A mathematical model to estimate exposure concentrations was used. To estimate exposure from the inhalation of volatile contaminants in groundwater while showering, the "Integrated Household Exposure Model for Use of Tap Water Contaminated with Volatile Organic Chemical," developed by S.A. Foster and P.C. Chrostowski, was applied. This model is presented in Appendix O.

7.3.1 Potential Human Receptors and Adjacent Populations

The following sections present a brief overview of the potential current and future exposure scenarios at Site 1.

7.3.1.1 Site Conceptual Model for Site 1

A site conceptual model of potential sources, migration pathways, and human receptors was developed to encompass all current and future potential routes of exposure at Site 1. This document is presented in Appendix Q. Figure 7-1 presents the flowchart of the potential exposure pathways and receptors for Site 1. Qualitative descriptions of current and future land use patterns in the vicinity of OU No.7 were provided in the conceptual model. All available analytical data and meteorological data were considered in addition to general understanding demographics of surrounding habitats.

From this information, the following general list of potential receptors were developed for inclusion in the quantitative health risk analysis for Site 1:

- Current military personnel
- Future on-site residents (child and adult)
- Future construction worker

The following sections describe the potential exposure pathways and receptors at Site 1 in further detail.

7.3.1.2 Current and Future Scenarios

At present, Site 1 is divided into a northern and southern portion. The northern portion is used for vehicle maintenance (Building FC-120) and also includes an office building for the Landing Support Battalion. The southern portion of the site is primarily used for equipment, various waste and vehicle storage. There also are office buildings in this portion of the site used by the Marine Corps 8th Engineers and Bridge Support Company. The majority of the site consists of a mixture of paved or coarse gravel road surfaces. Lawn and wooded areas border the site to the north, east, and west. Consequently, current receptors are on-site military personnel. The potential exposure pathways are surface soil incidental ingestion, dermal contact, and inhalation of fugitive dust from vehicular traffic.

Currently, the groundwater at the site is not used for potable purposes. A water supply well, HP-638, is located on site, but was shut down in 1993 due to benzene contamination (i.e., benzene was found at a maximum level of 2 µg/L). Consequently, exposure to groundwater is not considered to be applicable at the site. Exposure to subsurface soil is not expected for the on-site receptors. Surface water samples were not evaluated as part of the assessment, since the surface water was collected from a drainage ditch, which is not considered to be a significant source of surface water exposure. The ditches receive surface water runoff from the nearby parking lots. Groundwater does not directly discharge into these ditches. The sediment results were not included in the BRA.

Trespassers are not considered to be a viable receptor population. The southern portion of this site is guarded by a sentry. The northern portion of the site is primarily surrounded by a perimeter fence. These security measures are deemed sufficient to discourage and minimize trespassing. It is important to note that there is a hot dog stand within the southern portion of the site, manned by a civilian attendant. It is assumed that this stand is frequented by the on-site military personnel and/or visitors. However, it is assumed that the time spent on-site by visitors will be minimal. Consequently, visitors were not evaluated as part of the assessment of this site.

In the future case, it is expected that the site will remain a military restricted area. As stated previously, groundwater is currently not used for potable purposes. As a result, groundwater exposure was not assessed for future military personnel.

It is unlikely that this site will be used for a residential area in the future. However, to be conservative, groundwater exposure to a child and adult residential receptor was assessed. It is assumed that a private well could be installed on-site in the future case. The potential exposure pathways were ingestion, dermal contact, and inhalation while showering. It is important to note that both shallow and deep groundwater were evaluated for this scenario.

Similarly, it is anticipated that a residential child and adult may become exposed to subsurface soil in the future case. It is assumed that there may be excavation of subsurface soil and subsequent exposure as surface soils in the future case. As a result, subsurface soil exposure via ingestion, dermal contact and inhalation was evaluated for the future residential child and adult receptor.

Similarly, subsurface soil exposure resulting from future excavation and construction activities was assessed. A future construction worker was evaluated for subsurface soil ingestion, dermal contact, and inhalation.

Potable Water Supply

At the site, groundwater exposure is assumed to occur in the future case. At present, potable water for the site is supplied by the base treatment facilities via water supply wells. There are two potable water supply wells within a one-mile radius of Site 1. These supply wells, HP-638 and HP-655, are no longer in service. Consequently, the future groundwater exposure scenario is highly unlikely and conservative in nature. However, this exposure pathway was evaluated in accordance with USEPA guidance.

In addition, the shallow and deep groundwater at Site 1 was evaluated as a single exposure source. Although shallow groundwater is not used potably at the site, it has been shown that there is a potential interconnection between the shallow and deep aquifers (see Sections 4.3 and 4.4). Consequently, exposure to both sources of groundwater were evaluated.

7.3.2 Exposure Pathways

In general, the migration of COPCs from site soil sources could potentially occur by the following routes:

- Vertical migration of potential contaminants from surficial soils to subsurface soils.
- Leaching of potential contaminants from subsurface soils to the water-bearing zones.
- Vertical migration from shallow water-bearing zones to deeper flow systems.
- Horizontal migration in groundwater in the direction of groundwater flow.
- Groundwater discharge into local streams.
- Wind erosion and subsequent deposition of windblown dust.

The potential for a constituent to migrate spatially and persist in environmental media is important in the estimation of potential exposure. This section describes the potential exposure pathways presented on Figure 7-1 associated with each medium and each potential human receptor group, then qualitatively evaluates each pathway for further consideration in the quantitative risk analysis. Table 7-7 presents the potential human exposure scenarios for the site.

7.3.2.1 Surface Soil

The potential release source considered in the soil pathway was the chemical residuals in the surface soils. The release mechanisms considered were volatilization, fugitive dust generation/deposition, leaching, and surface runoff. The transport media were the surface soils and air. The routes for human exposure to the contaminated soils included ingestion, dermal contact, and inhalation. Potential exposure points from the site were areas of human activity on and adjacent to the site.

Soil Ingestion and Dermal Contact

Incidental ingestion and dermal contact with surface soil in the current case are complete exposure pathways for the current military receptor. These pathways were evaluated for potential risk.

Soil Inhalation Via Volatilization

The soil represents a potential source of exposure at the site via volatilization of COPCs. The potentially exposed population includes current military personnel who may inhale contaminated air. However, no VOCs were identified as COPCs in either media at the site. As a result, this pathway is not considered to be significant for the site and was not evaluated for the surface soils.

Soil Inhalation Via Fugitive Dust Generation

The surface soils in the current case represent a potential source of exposure at the site via fugitive dust generation from wind erosion and vehicular traffic on surface soils. Current military personnel may inadvertently inhale the liberated contaminated particulates as outdoor dust while engaging in outdoor activities.

Surface soil samples were collected on-site from each area of concern. Potential exposures to these soils may occur through incidental ingestion, absorption via dermal contact, and inhalation of airborne particulates containing COPCs.

7.3.2.2 Subsurface Soil

The potential release source considered in the subsurface soil pathway was the chemical residuals in the contaminated soils. The release mechanism considered was leaching to groundwater. The transport medium was the groundwater infiltrating the subsurface soil. Therefore, exposure to subsurface soils would be indirect (i.e., leaching of contaminants to groundwater). As such, subsurface soil exposure was addressed in the groundwater pathway analysis. Additionally, subsurface soil exposure was mentioned as part of the soil medium. It was assumed that the subsurface soil would be excavated and used as surface grading, landscaping, etc., in the foreseeable future. As a result, exposure to subsurface soil via ingestion and dermal contact was evaluated for the future construction worker, child, and adult receptor. The inhalation exposure pathway was also evaluated for the child, adult and construction worker receptor. It was assumed that this exposure would result from outdoor activities.

7.3.2.3 Groundwater

The potential release source considered in evaluating the groundwater pathway was contaminated soils. The release mechanism considered was soil leaching. The transport medium was the groundwater. The routes considered for human exposure to the groundwater were direct ingestion of groundwater, dermal contact during showering, and inhalation of volatilized contaminants during showering.

Residences located on-site in the future scenario were considered to be potential exposure points. At present, on-site groundwater is not potable. As a result, groundwater from on-site sources is not significant and was not evaluated for potential risk in the current scenario. In the future scenario, it conservatively is assumed that a potable well will be installed on-site. However, as stated previously, it is not expected that this residential scenario will be implemented in the future at these military sites. As a result, future groundwater risks on-site were assessed conservatively in accordance with guidance.

7.3.2.4 Surface Water

Potential release sources considered in evaluating the surface water pathway were the contaminated soils and groundwater. The release mechanisms considered were surface runoff and groundwater seepage. The transport medium was the surface water. The potential routes considered for human exposure to the contaminated surface water were incidental ingestion, dermal contact, and inhalation. Potential exposure points were areas of human activity on and adjacent to the site.

At Site 1, there were no surface water bodies available for evaluation. Consequently, no complete exposure pathways were present for this medium.

7.3.2.5 Sediment

The chemical residuals in the contaminated soils and groundwater are the potential release sources to be considered in the sediment pathway. The routes for human exposure to the contaminated sediments by the sediment pathway include ingestion and dermal contact. Potential exposure points from the site are areas of human activity adjacent to the site.

As stated previously, two sediment samples were collected from a drainage ditch at Site 1. It was determined that these samples did not represent sediment at the site. As a result, no complete exposure pathways were available for this medium.

7.3.2.6 Air

There are two potential release mechanisms to be considered in evaluating the atmospheric pathway: release of contaminated particulates (i.e., fugitive dust generation) and volatilization of contaminants from soil and groundwater. The transport mechanism is the air, and the potential exposure points are the areas of human activity on and adjacent to the site.

Fugitive Dust Generation

This air pathway was evaluated as a source of exposure outdoors at the site via fugitive dust generation of contaminants. Air exposure may occur when surface soils become airborne due to wind erosion or vehicular traffic. It is assumed that military personnel, as well as a child, adult and construction worker receptor may inhale soil particulates while engaging in outdoor activities. This is applicable for both the current and future cases. This exposure pathway is further assessed in Section 6.4.2, Exposure Pathways, under Surface and Subsurface Soil.

Volatilization

The air pathway via volatilization of contaminants from groundwater is a source of exposure at Site 1. It is assumed in the future scenario that an adult and child receptor will inhale volatilized contaminants present in groundwater while showering. This pathway is further discussed in Section 6.4.2, Exposure Pathways, under Groundwater. Also, see the section on Surface Soil for a discussion of the volatilization of contaminants from surface soil.

7.3.2.7 Biota

The potential release sources to be considered in evaluating exposure via fish consumption are contaminated surface water and sediments. Fish can uptake contaminants present in these media by bioaccumulation and biomagnification. The exposure route for human receptors is fish ingestion.

As stated previously, no surface water bodies were present at Site 1. Consequently, this exposure pathway is incomplete and was not evaluated as part of the BRA for this site.

7.3.3 Quantification of Exposure

The concentrations used in the estimation of chronic daily intakes (CDIs) must be representative of the type of exposure being considered. Exposure to groundwater, sediments, and surface waters can occur discretely or at a number of sampling locations. These media are transitory in that concentrations change frequently over time. Averaging transitory data obtained from multiple locations is difficult and requires many more data points at discrete locations than exist at Site 1. As a result, the best way to represent groundwater, sediment, and surface water contaminants from an exposure standpoint is to use a representative exposure concentration. Soils are less transitory than the aforementioned media and in most cases, exposure occurs over a wider area (i.e., residential exposure). Therefore, an upper confidence interval was used to represent a soil exposure concentration. Soil data collected from each of these areas was used separately in estimating the potential human health risks under current and future exposure scenarios. The human health assessment for future groundwater use considered groundwater data collected from all of the monitoring wells within a site and estimated risks to individuals per area of concern.

Since all the data sets originate from a skewed underlying distribution and since log-normal distribution best fits the majority of environmental data sets, the lognormal distribution was used to represent all facility media. This ensures conservatism in the estimation of chronic daily intake associated with potential exposures. Ninety-five percent upper confidence levels (95 percent UCL) derived for lognormal data sets produce concentrations in excess of the 95 percent interval derived assuming normality. For the sake of conservatism, the 95 percent UCL for the lognormal distribution was used for each contaminant in a given data set for quantifying potential exposure. For exposure areas with limited amounts of data or extreme variability in measured data, the 95 percent UCL can be greater than the maximum measured concentration; therefore, in cases where the 95 percent UCL for a contaminant exceeds the maximum detected value in a given data set, the maximum result was used in the estimate of exposure of the 95 percent UCL. However, the true mean may still be higher than this maximum value (i.e., the 95 percent UCL indicates a higher mean is possible), especially if the most contaminated portion of the site has not been sampled.

The following criteria were used to calculate media-specific average concentrations for each parameter that was detected at least once:

- For results reported as "non-detect" (e.g., ND, U, etc.), a value of one-half of the sample-specific detection limit was used to calculate the mean. The use of one-half the detection limit commonly is assigned to non-detects when averaging data for risk assessment purposes, since the actual value could be between zero and a value just below the detection limit.

- Reported concentrations that were less than the detection limit were used to calculate the mean. Typically, these values are qualified with a "J" meaning that the value was estimated.
- Reported concentrations qualified with "R" were excluded from the data set. The data flag "R" means that the QA/QC data indicated that analytical results were not usable for quantitative purposes.

The reduced data were summarized by medium and analytical parameter type (i.e., organics and inorganics) for the site. For each parameter detected during the sampling programs, the frequency of detection, maximum concentration, minimum concentration, average (arithmetic mean) concentration and both the normal and lognormal upper 95 percent level for the arithmetic average were summarized. This information is presented in Appendix K. It should be noted that the number of times analyzed may differ per parameter per media per area of concern. This is primarily due to data rejected due to QA/QC problems and excluded from the data set. Consequently, these data are not reflected in the number of times analyzed.

Data and frequency summaries and statistical summaries are presented in Appendices K and L, respectively.

7.3.4 Calculation of Chronic Daily Intakes

In order to numerically estimate the risks for current and future human receptors at Site 1, a CDI must be estimated for each COPC in every retained exposure pathway. Appendix R contains the specific CDI equations for each exposure scenario of interest. These equations were obtained from USEPA guidance (USEPA, 1989).

The following paragraphs present the general equations and input parameters used in the calculation of CDIs for each potential exposure pathway. Input parameters were taken from USEPA's default exposure factors guidelines where available and applicable. All inputs not defined by USEPA were derived from USEPA documents concerning exposure or from best professional judgment. All exposure assessments incorporate the representative COPC concentrations in the estimation of intakes. Therefore, only one exposure scenario was developed for each exposure route/receptor combination.

Carcinogenic risks were calculated as an incremental lifetime risk and, therefore, incorporate terms representing the exposure duration (years) over the course of a lifetime (70 years, or 25,550 days).

Noncarcinogenic risks, on the other hand, were estimated using the concept of an average annual exposure. The intake incorporates terms describing the exposure time and/or frequency representing the number of hours per day and the number of days per year that exposure occurs. In general, noncarcinogenic risks for many exposure routes (e.g., soil ingestion) are greater for children than adults because of the differences in body weights, similar exposure frequencies, and higher ingestion rates.

Future residential exposure scenarios consider 1 to 6 year old children weighing 15 kg and adults weighing 70 kg on average. For current/future military personnel an exposure duration of 4 years was used to estimate a military residence. A one-year duration of exposure was used for future construction worker scenarios.

7.3.4.1 Incidental Ingestion of Soil

The CDI for COPCs detected in soil was estimated for all potential human receptors and was expressed as:

$$CDI = \frac{C \times IR \times CF \times Fi \times EF \times ED}{BW \times AT}$$

Where:

C	=	Contaminant concentration in soil (mg/kg)
IR	=	Ingestion rate (mg/day)
CF	=	Conversion factor (1x10 ⁻⁶ kg/mg)
Fi	=	Fraction ingested from source (dimensionless)
EF	=	Exposure frequency (days/year)
ED	=	Exposure duration (years)
BW	=	Body weight (kg)
AT	=	Averaging time (days)

The following paragraphs discuss the exposure assumptions used in the estimation of exposure to COPCs associated with the ingestion of soils.

Military Personnel

During the course of daily activities at Site 1, military personnel could potentially be exposed to COPCs by the incidental ingestion of surface soils. The IR for military personnel exposed to surficial soils was assumed to be 100 mg/day (USEPA, 1989) and that 100 percent of the exposure was with facility soils containing COPCs. An exposure frequency (EF) of 250 days per year was used in conjunction with an exposure duration of 4 years. An averaging time (AT) of 70 years or 25,550 days was used for exposure to potentially carcinogenic compounds while an averaging time of 1,460 days (4 years x 365 days/year) was used for noncarcinogenic exposures. An adult average body weight (BW) of 70 kg was used (USEPA, 1989).

Future On-Site Residents

Future on-site residents could potentially be exposed to COPCs in the surficial soils during recreational or landscaping activities around their homes. Children and adults could potentially be exposed to COPCs in subsurface soils by incidental ingestion occurring via hand to mouth contact. Ingestion rates (IR) for adults and children in this scenario were assumed to be 100 mg/day and 200 mg/day, respectively. EFs for both receptor groups was assumed to be 350 days per year. The residential exposure duration (ED) was divided into two parts. First, a six-year exposure duration was evaluated for young children which accounts for the period of highest soil ingestion (200 mg/day), and second a 30-year exposure was assessed for older children and adults by using a lower soil ingestion rate (100 mg/day) (USEPA, 1991). The body weight (BW) for a resident child was assumed to be 15 kg, representing younger individuals. The rationale was that the younger child (1 to 6 years), as a resident, will have access to affected on-site soils. The body weight for the future resident adult is assumed to be 70 kg. Averaging times (ATs) of 25,550 days for potential carcinogens and 10,950 days (30 years x 365 days/year) for noncarcinogenic constituents was used

for estimating potential CDIs for adults. An AT of 2,190 days (6 years x 365 days/year) was used to estimate potential CDIs for children potentially exposed to noncarcinogens.

Future Construction Worker

During the course of excavation activities, construction workers could potentially be exposed to COPCs through the incidental ingestion of subsurface soil. The IR for future construction workers exposed to subsurface soils was assumed to be 480 mg/day (USEPA, 1991). An exposure frequency of 90 days per year was used in conjunction with an exposure duration of one year (USEPA, 1991). An adult BW of 70 kg was used.

A summary of the exposure factors used in the estimation of soil CDIs associated with incidental ingestion is presented in Table 7-6.

7.3.4.2 Dermal Contact with Soil

Chronic daily intakes associated with potential dermal contact of soils containing COPCs was expressed using the following equation:

$$CDI = \frac{C \times CF \times SA \times AF \times ABS \times EF \times ED}{BW \times AT}$$

Where:

C	=	Contaminant concentration in soil (mg/kg)
CF	=	Conversion factor (kg/mg)
SA	=	Skin surface available for contact (cm ²)
AF	=	Soil to skin adherence factor (1.0 mg/cm ²)
ABS	=	Absorption factor (dimensionless) - 0.01 for organics, 0.001 for inorganics (USEPA, Region IV, 1992d)
EF	=	Exposure frequency (days/year)
ED	=	Exposure duration (years)
BW	=	Body weight (kg)
AT	=	Averaging time (days)

The following paragraphs discuss the exposure assumptions used in the estimation of exposure to COPCs via dermal contact with soils.

Military Personnel

During outdoor activities, there is a potential for base personnel to absorb COPCs by dermal contact. The exposed skin surface area (4,300 cm²) was limited to the head (1,180 cm²), arms (2,280 cm²), and hands (840 cm²) (USEPA, 1992). Values for exposure duration (ED), exposure frequency (EF), body weight (BW), and averaging time (AT) were the same as those used for the incidental ingestion of soil scenario. The values of AF and ABS were provided with the equation and correspond to USEPA and Region IV guidance.

Future On-Site Residents

Future on-site residents could also be potentially exposed to COPCs in on-site soil through dermal contact while participating in outdoor activities near their home. Skin surface areas (SA) used in the on-site resident exposure scenario were developed for a reasonable worst case scenario for an individual wearing a short-sleeved shirt, shorts, and shoes. The exposed skin surface area was limited to the head, hands, forearms, and lower legs. Thus, applying 25 percent of the total body surface area results in a default of 5,800 cm² for adults. The exposed skin surface for a child (2,300 cm²) was estimated using an average of the 50th (0.866 m²) and the 95th (1.06 m²) percentile body surface for a six year old child multiplied by 25 percent (USEPA, 1992). Exposure duration, exposure frequencies, body weights and averaging times were the same as those discussed for the incidental ingestion scenario presented previously. The values of AF and ABS were provided with the equation and correspond to USEPA and Region IV guidance.

Future Construction Worker

Dermal contact with subsurface soil COPCs could potentially occur during excavation activities. Skin surface area (SA) used for the construction worker exposure scenario were developed for an individual wearing a short-sleeved shirt, long pants, and boots. The exposed skin surface area (4,300 cm²) was limited to the head (1,180 cm²), arms (2,280 cm²), and hands (840 cm²) (USEPA, 1992). The exposure frequency and exposure duration are the same as those discussed for incidental ingestion of subsurface soil. The values of AF and ABS were provided with the equation and correspond to USEPA and Region IV guidance. A summary of the soil exposure assessment input parameters for dermal contact are presented in Table 7-6.

7.3.4.3 Inhalation of Fugitive Particulates

Exposure to fugitive particulates was estimated for future residents and base personnel. These populations may be exposed during daily recreational or work-related activities. The chronic daily intake of contaminants associated with the inhalation of particulates was estimated using the following equation:

$$CDI = \frac{C \times IR \times EF \times ED \times 1/PEF}{BW \times AT}$$

Where:

C	=	Contaminant concentration in soil (mg/kg)
IR	=	Inhalation rate (m ³ /day)
EF	=	Exposure frequency (days/year)
ED	=	Exposure duration (years)
1/PEF	=	Particulate emission factor (m ³ /kg)
BW	=	Body weight (kg)
AT	=	Averaging time (days)

The PEF relates the concentration in soil with the concentration of respirable particles in the air from fugitive dust emissions. This relationship is derived by Cowherd (1985). The particulate emissions from contaminated sites are caused by wind erosion, and, therefore, depend on erodibility of the

surface material. A default PEF obtained from USEPA guidance (USEPA, 1989b) was used in this assessment.

The following paragraphs discuss the exposure assumptions used in this estimation of exposure to COPCs via inhalation of particulates.

Military Personnel

During work related activities, military personnel may inhale COPCs emitted as fugitive dust. An inhalation rate 30 m³/day will be used for military personnel (USEPA, 1991). Values for exposure duration, exposure frequency, body weight, and averaging time were the same as those used for the soil incidental ingestion scenario.

Future On-Site Residents

Future on-site residents may also inhale particulates during activities near their homes. Inhalation rates (IR) used in the on-site resident exposure scenario were 20 m³/day and 10 m³/day for adults and children, respectively (USEPA, 1989). Exposure frequencies, duration, body weights, and averaging time were the same as those used for the soil incidental ingestion scenario. Table 7-6 presents the exposure factors used to estimate CDIs associated with the particulate inhalation scenario.

Future Construction Worker

Future construction workers could become exposed to subsurface soil particulates during excavation activities. The inhalation rate (IR) used was 20 m³/day (USEPA, 1989). Exposure frequencies, duration, body weight, and averaging time were the same as those used for the soil incidental ingestion scenario. Table 7-6 presents the exposure factors used to estimate CDIs associated with the particulate inhalation scenario.

7.3.4.4 Ingestion of Groundwater

As stated previously, shallow groundwater is not currently being used as a potable supply at Site 1. Development of the shallow aquifer for potable use is unlikely because of its general water quality and poor flow rates. However, residential housing could be constructed, and groundwater could be used for potable purposes in the future. Consequently, shallow and deep groundwater exposure was evaluated.

The CDI of contaminants associated with the future potential consumption of groundwater was estimated using the following general equation:

$$CDI = \frac{C \times IR \times EF \times ED}{BW \times AT}$$

Where:

C	=	Contaminant concentration in groundwater (mg/L)
IR	=	Ingestion rate (L/day)
EF	=	Exposure frequency (days/year)

ED	=	Exposure duration (years)
BW	=	Body weight (kg)
AT	=	Averaging time (days)

The following paragraphs discuss the exposure assumptions used to estimate exposure to COPCs from ingestion of groundwater.

Future On-Site Residents

Exposure to COPCs via ingestion of groundwater was retained as a potential future exposure pathway for both children and adults. An IR of 1.0 L/day was used for the amount of water consumed by a 1 to 6 year old child weighing 15 kg. This ingestion rate provides a conservative exposure estimate (for systemic, noncarcinogenic toxicants) designed to protect young children who may be more affected than adolescents or adults. This value assumes that children obtain all the tap water they drink from the same source for 350 days/year (which represents the exposure frequency [EF]). An averaging time (AT) of 2,190 days (6 years x 365 days/year) is used for noncarcinogenic compound exposure. The ingestion rate (IR) for adults was 2 liters/day (USEPA, 1989). The ED used for the estimation of adult CDIs was 30 years (USEPA, 1989), which represents the national upper-bound (90th percentile) time at one residence. The averaging time for noncarcinogens was 10,950 days. An averaging time (AT) of 25,550 days (70 years x 365 days/year) was used to evaluate exposure for both children and adults to potential carcinogenic compounds. Table 7-6 presents a summary of the input parameters for the ingestion of groundwater scenarios.

7.3.4.5 Dermal Contact with Groundwater

The CDI associated with the dermal contact with groundwater was estimated using the following general equation:

$$CDI = \frac{C \times SA \times PC \times ET \times EF \times ED \times CF}{BW \times AT}$$

Where:

C	=	Contaminant concentration in groundwater (mg/L)
SA	=	Surface area available for contact (cm ²)
PC	=	Dermal permeability constant (cm/hr)
ET	=	Exposure time (hour/day)
EF	=	Exposure frequency (days/year)
ED	=	Exposure duration (years)
CF	=	Conversion factor (1 L/1000 cm ³)
BW	=	Body weight (kg)
AT	=	Averaging time (days)

The following paragraphs discuss the exposure assumptions used in the estimation of exposure to COPCs via dermal contact with groundwater.

Future On-Site Residents

Children and adults could contact COPCs through dermal contact with groundwater while bathing or showering. It was assumed that bathing would take place 350 days/year using site groundwater

as the sole source. The whole body skin surface area (SA) available for dermal absorption was estimated to be 10,000 cm² for children and 23,000 cm² for adults (USEPA, 1992). The permeability constant (PC) reflects the movement of a chemical across the skin and into the blood stream. The permeability of a chemical is an important property in evaluating actual absorbed dose, yet many compounds do not have literature PC values. For contaminants in which a PC value has not been established, the permeability constant was calculated used and/or the default PC value for inorganics (0.001 cm/hr) was used (USEPA, 1992). These values may in fact be realistic estimates of the adsorption rate of a chemical when COPC concentrations are in the part-per-billion range. An exposure time (ET) of 0.25 hour/day was used to conservatively estimate the duration of bathing or showering. The exposure duration, body weight, and averaging time were the same as those used for the ingestion of groundwater scenario. Table 7-6 presents the exposure factors used to estimate CDIs associated with the future dermal contact with COPCs in groundwater.

7.3.4.6 Inhalation of Volatile Organics While Showering

In order to quantitatively assess the inhalation of contaminants volatilized from shower water, the model developed by Foster and Chrostowski (1986) was utilized. Contaminant concentrations in air were modeled by estimating the following: the rate of chemical releases into air (generation rate), the buildup of VOCs in the shower room air while the shower was on, the decay of VOCs in the shower room after the shower was turned off, and the quantity of airborne VOCs inhaled while the shower was both on and off. The contaminant concentrations calculated to be in the air were then used as the concentration term.

The CDI associated with the inhalation of airborne (vapor phase) VOCs from groundwater while showering was estimated using the following general equation:

$$CDI = \frac{C \times IR \times ET \times EF \times ED}{BW \times AT}$$

Where:

C	=	Contaminant concentration in air (mg/m ³)
IR	=	Inhalation rate (m ³ /hr)
ET	=	Exposure time (hr/day)
EF	=	Exposure frequency (days/year)
ED	=	Exposure duration (years)
BW	=	Body weight (kg)
AT	=	Averaging time (days)

Future On-Site Residents

Both children and adults could inhale vaporized volatile organic COPCs during showering. It was assumed that showering would take place 350 days/year, using site groundwater as the sole source, for children weighing 15 kg, and adults weighing 70 kg (USEPA, 1989). An inhalation rate of 0.6 m³/hr was used for both receptors (USEPA, 1989). An exposure time of 0.25 hrs/day was used for both receptors (USEPA, 1989). The exposure duration and averaging times remained the same as for groundwater ingestion.

Table 7-6 presents the exposure factors used to estimate CDIs associated with the inhalation of VOCs from groundwater while showering.

7.4 Toxicity Assessment

The purpose of this section is to define the toxicological values used to evaluate the potential exposure to the potential COPCs identified in Section 7.2. A toxicological evaluation characterizes the inherent toxicity of a compound. It consists of the review of scientific data to determine the nature and extent of the potential human health and environmental effects associated with exposure to various contaminants.

Human data from occupational exposures are often insufficient for determining quantitative indices of toxicity because of uncertainties in exposure estimates and inherent difficulties in determining causal relationships established by epidemiological studies. For this reason, animal bioassays are conducted under controlled conditions and their results are extrapolated to humans. There are several stages to this extrapolation. First, to account for species differences, conversion factors are used to extrapolate from test animals to humans. Second, the relatively high doses administered to test animals must be extrapolated to the lower doses more typical of human exposures. For potential noncarcinogens, safety factors and modifying factors are applied to animal results when developing acceptable human doses. For potential carcinogens, mathematical models are used to extrapolate effects at high doses to effects at lower doses. Epidemiological data can be used for inferential purposes to establish the credibility of the experimentally derived indices.

The available toxicological information indicates that many of the COPCs have both potential carcinogenic and noncarcinogenic health effects in humans and/or experimental animals. Although the COPCs may cause adverse health and environmental impacts, dose-response relationships and the potential for exposure must be evaluated before the risk to receptors can be determined. Dose-response relationships correlate the magnitude of the dose with the probability of toxic effects, as discussed in the following section.

An important component of the risk assessment is the relationship between the dose of a compound (amount to which an individual or population is potentially exposed) and the potential for adverse health effects resulting from the exposure to that dose. Dose-response relationships provide a means by which potential public health impacts may be evaluated. The published information on doses and responses is used in conjunction with information on the nature and magnitude of exposure to develop an estimate of risk.

Standard carcinogenic slope factors (CSFs) and/or reference doses (RfDs) have been developed for many of the COPCs. This section provides a brief description of these parameters.

7.4.1 Carcinogenic Slope Factor

CSFs are used to estimate an upper-bound lifetime probability of an individual developing cancer as a result of exposure to a particular level of a potential carcinogen (USEPA, 1989). This factor is generally reported in units of $(\text{mg}/\text{kg}/\text{day})^{-1}$ and is derived through an assumed low-dosage linear multistage model and an extrapolation from high to low dose-responses determined from animal studies. The value used in reporting the slope factor is the upper 95th percent confidence limit.

These slope factors are also accompanied by USEPA weight-of-evidence (WOE) classifications, which designate the strength of the evidence that the COPC is a potential human carcinogen.

In assessing the carcinogenic potential of a chemical, the Human Health Assessment Group (HHAG) of USEPA classifies the chemical into one of the following groups, according to the weight of evidence from epidemiologic and animal studies:

Group A - Human Carcinogen (sufficient evidence of carcinogenicity in humans)

Group B - Probable Human Carcinogen (B1 - limited evidence of carcinogenicity in humans; B2 - sufficient evidence of carcinogenicity in animals with inadequate or lack of evidence in humans)

Group C - Possible Human Carcinogen (limited evidence of carcinogenicity in animals and inadequate or lack of human data)

Group D - Not Classifiable as to Human Carcinogenicity (inadequate or no evidence)

Group E - Evidence of Noncarcinogenicity for Humans (no evidence of carcinogenicity in adequate studies)

7.4.2 Reference Dose

The RfD is developed for chronic and/or subchronic human exposure to chemicals and is based solely on the noncarcinogenic effects of chemical substances. It is defined as an estimate of a daily exposure level for the human population, including sensitive populations, that is not likely to be cause an appreciable risk of adverse effects during a lifetime. The RfD is usually expressed as dose (mg) per unit body weight (kg) per unit time (day). It is generally derived by dividing a no-observed-(adverse)-effect-level (NOAEL or NOEL) or a lowest observed-adverse-effect-level (LOAEL) for the critical toxic effect by an appropriate uncertainty factor (UF). Effect levels are determined from laboratory or epidemiological studies. The UF is based on the availability of toxicity data.

UFs usually consist of multiples of 10, where each factor represents a specific area of uncertainty naturally present in the extrapolation process. These UFs are presented below and were taken from the Risk Assessment Guidance Document for Superfund, Volume I, Human Health Evaluation Manual (Part A) (USEPA, 1989):

- A UF of 10 is to account for variation in the general population and is intended to protect sensitive populations (e.g., elderly, children).
- A UF of 10 is used when extrapolating from animals to humans. This factor is intended to account for the interspecies variability between humans and other mammals.
- A UF of 10 is used when a NOAEL derived from a subchronic instead of a chronic study is used as the basis for a chronic RfD.

- A UF of 10 is used when a LOAEL is used instead of a NOAEL. This factor is intended to account for the uncertainty associated with extrapolating from LOAELs to NOAELs.

In addition to UFs, a modifying factor (MF) is applied to each reference dose and is defined as:

- A MF ranging from >0 to 10 is included to reflect a qualitative professional assessment of additional uncertainties in the critical study and in the entire data base for the chemical not explicitly addressed by the preceding uncertainty factors. The default for the MF is 1.

Thus, the RfD incorporates the uncertainty of the evidence for chronic human health effects. Even if applicable human data exist, the RfD still maintains a margin of safety so that chronic human health effects are not underestimated.

Toxicity factors and the USEPA WOE classifications are presented in Table 7-8. The hierarchy (USEPA, 1989) for choosing these values was as follows:

- Integrated Risk Information System (IRIS, 1994)
- Health Effects Assessment Summary Table (HEAST, 1994)

The IRIS data base is updated monthly and contains both verified CSFs and RfDs. The USEPA has formed the Carcinogen Risk Assessment Verification Endeavor (CRAVE) Workgroup to review and validate toxicity values used in developing CSFs. Once the slope factors have been verified via extensive peer review, they appear in the IRIS data base. Like the CSF Workgroup, the USEPA has formed a RfD Workgroup to review existing data used to derive RfDs. Once the reference doses has been verified, they also appear in IRIS.

HEAST on the other hand, provides both interim (unverified) and verified CSFs and RfDs. This document is published quarterly and incorporates any applicable changes to its data base.

Toxicity values will be obtained primarily from the Region III Risk-Based Concentration Table, which is based on IRIS, HEAST and provisional and/or recommended USEPA toxicity values, in accordance with Region IV recommendations.

For some chemicals, there are no USEPA-verified toxicity values (i.e., RfDs and CSFs) available for risk quantitation. This is the case for lead. The following section provides a discussion of how lead health effects were quantified for this assessment.

7.4.3 Lead

Lead was identified as a COPC in surface and subsurface soil at Site 1. Currently, health-based criteria are not available for evaluating either the noncarcinogenic or carcinogenic effects of lead exposure. The USEPA has not developed health-based criteria because a threshold level for many noncancer health effects has not been identified in infants and younger children (i.e., the most sensitive populations). Consequently, risk from lead exposure was not calculated for any of the sites.

To evaluate lead at waste sites, the USEPA had developed a lead uptake/biokinetic (UBK) model. This model utilizes site-specific exposure parameters to estimate blood lead levels in infants and young children. The USEPA considers remediation necessary if a 5 percent probability or greater exists that the predicted child blood level will exceed 10 ug/dl as a result of contact with lead-containing media at the site.

There are several criteria available for lead level comparisons in the form of standards, criteria and/or TBCs. These standards/criteria/TBCs include federal and state MCLs, AWQC, and USGS background levels for metals in urban soils. In addition, there is an Office of Solid Waste and Emergency Response (OSWER) directive for lead in soil. The concentration range was 500 to 1,000 ppm. However, according to the USEPA Region IV office, there is an upcoming addendum which states that the level is now 400 ppm. The maximum concentrations of lead found in the soil did not exceed this level. Consequently, the lead UBK model was not utilized.

7.4.4 Dermal Adjustment of Toxicity Factors

Because there are few toxicity reference values for dermal exposure, oral values are frequently used to assess risk from dermal exposure. Most RfDs and some slope factors are expressed as the amount of substance administered per unit time and unit body weight, while exposure estimates for the dermal route are expressed as absorbed dose. Consequently, it may be necessary to adjust an oral toxicity value from an administered dose to an absorbed dose.

Region IV provides absorption efficiency values for each class of chemicals. They are as follows:

VOCs	=	0.80
SVOCs	=	0.50
Inorganics	=	0.20
Pesticides/PCBs	=	0.50

An adjusted oral RfD is the product of the absorption efficiency and the oral toxicity reference value. The adjusted oral CSF is the ratio of the oral toxicity value and the absorption efficiency. Table 7-9 presents a summary of the dermally-adjusted toxicity values used in this BRA.

7.5 Risk Characterization

This section presents and discusses the estimated incremental lifetime cancer risks (ICRs) and hazard indices (HIs) for identified potential receptor groups which could be exposed to COPCs via the exposure pathways presented in Section 7.3.

These quantitative risk calculations for potentially carcinogenic compounds estimate ICRs levels for an individual in a specified population. This unit risk refers to the cancer risk that is over and above the background cancer risk in unexposed individuals. For example, an ICR of 1×10^{-6} indicates that, for a lifetime exposure, one additional case of cancer may occur per one million exposed individuals.

The ICR to individuals was estimated from the following relationship:

$$ICR = \sum_{i=1}^n CDI_i \times CSF_i$$

where CDI_i is the chronic daily intake (mg/kg/day) for compound i and CSF_i is the cancer slope in (mg/kg/day)⁻¹ for contaminant i . The CSF is defined in most instances as an upper 95th percentile confidence limit of the probability of a carcinogenic response based on experimental animal data, and the CDI is defined as the exposure expressed as a mass of a substance contracted per unit body weight per unit time, averaged over a period of time (i.e., six years to a lifetime). The above equation was derived assuming that cancer is a non-threshold process and that the potential excess risk level is proportional to the cumulative intake over a lifetime.

In contrast to the above approach for potentially carcinogenic effects, quantitative risk calculations for noncarcinogenic compounds assume that a threshold toxicological effect exists. Therefore, the potential for noncarcinogenic effects is calculated by comparing CDIs with threshold levels (reference doses).

Noncarcinogenic effects were estimated by calculating the hazard index (HI) which is defined as:

$$HI = HQ_1 + HQ_2 + \dots + HQ_n \text{ or}$$

$$HI = \sum_{i=1}^n HQ_i$$

$$\text{where } HQ_i = CDI_i / RfD_i$$

HQ_i is the hazard quotient for contaminant i , CDI_i is the chronic daily intake (mg/kg/day) of contaminant i , and RfD_i is the reference dose (mg/kg/day) of the contaminant i over a prolonged period of exposure.

7.5.1 Human Health Risks

The following paragraphs present the quantitative results of the human health evaluation for each medium and area of concern at Site 1. The results are summarized in Table 7-10 and 7-11.

Estimated ICRs were compared to the target risk range of 1×10^{-4} to 1×10^{-6} . A value of 1.0 was used for examination of the HI. The HI was calculated by comparing estimated CDIs with threshold levels below which, noncarcinogenic health effects are not expected to occur. Any HI equal to or exceeding 1.0 suggested that noncarcinogenic health effects were possible. If the HI was less than 1.0, then systemic human health effects were considered unlikely.

7.5.1.1 Current Military Personnel

The current military receptor was evaluated for potential noncarcinogenic and carcinogenic risk from exposure to the surface soil at Site 1. Both total noncarcinogenic (i.e., 0.03) and carcinogenic risks (i.e., 1.3×10^{-7}) from exposure to surface soil for this receptor fell within the acceptable risk levels.

7.5.1.2 Future Residential Child

The child receptor was evaluated for potential risk from exposure to subsurface soil and groundwater in the future scenario. In subsurface soil, the noncarcinogenic (i.e., 0.14) and carcinogenic risks (i.e., 2.5×10^{-6}) for this receptor were within the acceptable risk levels. In groundwater, there is a potential noncarcinogenic risk via ingestion for the child receptor. The noncarcinogenic risk level from groundwater was 17.7. This value exceeded the acceptable risk level of one for noncarcinogenic risks. Arsenic and manganese contributed to this risk. The carcinogenic risk from groundwater exposure (i.e., 8.3×10^{-5}) was within the target risk range of 1×10^{-4} to 1×10^{-6} .

7.5.1.3 Future Residential Adult

The adult receptor was evaluated for potential risk from exposure to subsurface soil and groundwater in the future scenario. In subsurface soil, the potential noncarcinogenic (i.e., 0.019) and carcinogenic risks (i.e., 1.6×10^{-6}) from exposure to this medium fell within the acceptable risk level. In groundwater, the potential noncarcinogenic and carcinogenic risks from ingestion did not fall within the acceptable risk levels. The potential noncarcinogenic and carcinogenic risks from groundwater ingestion were 7.5 and 1.8×10^{-4} , respectively. Arsenic and manganese contributed to the risks.

7.5.1.4 Future Construction Worker

The construction worker was evaluated for potential noncarcinogenic and carcinogenic risk from exposure to the subsurface soil in the future case. Both noncarcinogenic (i.e., 1.1×10^{-3}) and carcinogenic risks (i.e., 5.4×10^{-8}) from exposure to the subsurface soil for this receptor fell within the acceptable risk levels.

7.6 Standards/Criteria/TBC Comparison Results

The following subsections provide a brief summary of the COPCs identified in each medium of concern that exceed an standard/criteria/TBC.

7.6.1 **Surface Soil**

When comparing the background surface soil total metal concentrations to maximum USGS levels, there were no exceedances. On comparison of the total metal levels in the site surface soils to the maximum USGS levels, antimony (3/14) and cadmium (2/14) exceeded the levels. The following inorganic COPCs in the site surface soil exceeded twice the average site background level: aluminum (1/14), antimony (3/14), arsenic (4/14), cadmium (2/14), calcium (9/14), chromium (5/14), iron (1/14), magnesium (8/14), manganese (1/14), sodium (1/14), vanadium (2/14) and zinc (5/14).

7.6.2 **Subsurface Soil**

On comparison of Site 1 background subsurface soil total metal concentrations to maximum USGS levels, there were no exceedances. On comparison of the total metal levels in the site subsurface soils to the maximum USGS levels, only cadmium exceeded the level at a frequency of 1 out of 110 analyzed. The following inorganic COPCs in the site subsurface soil exceeded twice the average site background level: aluminum (19/110), antimony (3/110), arsenic (34/110), barium (23/110), cadmium (5/110), calcium (71/110), chromium (23/110), cobalt (5/110), copper (9/110), iron (31/110), magnesium (39/110), lead (20/110), manganese (32/110), mercury (5/110), potassium

(18/110), nickel (20/110), selenium (1/110), sodium (7/110), vanadium (24/110) and zinc (25/110). Silver did not exceed site background levels.

7.6.3 Groundwater

Chloromethane, vinyl chloride, 1,2-DCE, TCE and xylene were compared to federal and state MCLs. There is currently no federal MCL for 1,2-DCE and chloromethane. Vinyl chloride and TCE exceeded the federal MCLs both at a frequency of 1 out of 18 analyzed. There is a state MCL for all the detected VOCs except chloromethane. Vinyl chloride exceeded the state level at a frequency of 1 out of 18 analyzed. TCE exceeded the state MCL at a frequency of 2 samples out of 18 analyzed. 1,2-DCE and xylene did not exceed the state levels.

Phenol, diethylphthalate, and BEHP were found in the groundwater. BEHP has a Federal MCL. Diethylphthalate has a state MCL. BEHP exceeded the federal MCL at a frequency of 1 out of 19. Diethylphthalate did not exceed the state level.

The following metals detected in the shallow and deep groundwater have federal MCLs currently available for comparison: arsenic, barium, lead, and mercury. On comparison of total metals concentrations in the shallow and deep groundwater to federal MCLs, no metals exceeded the federal criteria. There are currently no federal MCLs available for the following inorganic COPCs: aluminum, calcium, iron, magnesium, cobalt, manganese, potassium, sodium and vanadium.

The following COPCs have state MCLs currently available for comparison: arsenic, barium, iron, lead, manganese, and mercury. On comparison of total metals concentrations in the shallow and deep groundwater to state MCLs, the following metals exceeded the state criteria: iron (8/18), manganese (5/18), and mercury (1/14). There are currently no state MCLs available for the following inorganic COPCs: aluminum, calcium, cobalt, magnesium, potassium, sodium and vanadium.

7.7 Sources of Uncertainty

Uncertainties may be encountered throughout the BRA process. This section discusses the sources of uncertainty involved with the following:

- Analytical data
- Exposure Assessment
- Toxicity Assessment
- Compounds Not Qualitatively Evaluated

In addition, the USEPA stresses the importance of recognizing the unique characteristics and circumstances of each site and the need to formulate site-specific responses. However, many of the assumptions presented in this document were derived from USEPA guidance, which is designed to provide a conservative approach and cover a broad variety of cases. As such, the generic application of such assumptions to a site in the RME case scenario may work against the objective of formulating a site-specific response to a constituent presence (i.e., it is possible that the site risks may be overestimated). This section presents a discussion of these sources of uncertainty and how they may affect the resulting calculated risk for the site.

7.7.1 Analytical Data Uncertainty

The development of a BRA depends on the reliability of and uncertainties with the analytical data available to the risk assessor. Analytical data are limited by the precision and accuracy of the analytical method of analysis. In addition, the statistical methods used to compile and analyze the data (mean concentration, standard deviation, and detection frequencies) are subject to the uncertainty in the ability to acquire data.

Data validation serves to reduce some of the inherent uncertainty associated with the analytical data by establishing the usability of the data to the risk assessor who may or may not choose to include the data point in the estimation of risk. Data qualified as "J" (estimated) were retained for the estimation of risk at OU No.7. Data can be qualified as estimated for many reasons including a slight exceedance of holding times, high or low surrogate recovery, or intra sample variability. Organic data qualified "B" (detected in blank) or "R" (unreliable) were not used in the estimation of risk due to the unusable nature of the data. Due to the comprehensive sampling and analytical program at OU No.7, the loss of some data points qualified "B" or "R" did not significantly increase the uncertainty in the estimation of risk.

7.7.2 Exposure Assessment Uncertainty

In performing exposure assessments, uncertainties can arise from two main sources. First, the chemical concentration to which a receptor may be exposed must be estimated for every medium of interest. Second, uncertainties can arise in the estimation of contaminant intakes resulting from contact by a receptor with a particular medium.

Estimating the contaminant concentration in a given medium to which a human receptor could potentially be exposed can be as simple as deriving the 95th percent upper confidence limit of the mean for a data set. More complex methods of deriving the contaminant concentration are necessary when exposure to COPCs in a given medium occurs subsequent to release from another medium, or when analytical data are not available to characterize the release. In this case, modeling is usually employed to estimate the potential human exposure.

The potential inhalation of fugitive dusts from affected soils was estimated in the BRA using USEPA's Rapid Assessment of Exposure to Particulate Emissions from Surface Contaminated Sites (Cowherd et al. 1985). The Cowherd model employs the use of a site-specific PEF for wind erosion based on source area and vegetative cover. A conservative estimate of the PEF was derived for Site 1 by assuming that the entire area was not covered with vegetation and was unlimited in its erosion potential. Modeling results for fugitive dust emission exposure suggested that the potential risk associated with this pathway was not significant.

Groundwater samples were analyzed for total (unfiltered) and dissolved (filtered) inorganic contaminants. These samples were obtained from wells which were constructed using USEPA Region IV monitoring well design specifications. Groundwater taken from monitoring wells cannot be considered representative of potable groundwater or groundwater which is obtained from a domestic well at the tap. The use of total inorganic analytical results overestimates the potential human health risks associated with potable use scenarios. However, for the sake of conservatism, total organic results were used to estimate the potential intake associated with groundwater use.

Currently, the shallow groundwater is not used as a potable source. Current receptors (military personnel, military dependents, and civilian base personnel) are exposed via ingestion, dermal contact, and inhalation to groundwater drawn from the deep zone. Therefore, assessing current risks to contaminants detected in the shallow aquifer for current receptors is unnecessary and, if estimated, may present an unlikely risk. Therefore, groundwater exposure to current receptors was not estimated for this investigation.

There are no surface water bodies of concern at this site. As a result, current and/or future potential exposure via ingestion of surface water while swimming was not assessed. The surface water body included in this investigation (i.e., the drainage ditch) is not sufficient in size or depth to support recreational swimming. Therefore, the probability of exposure via this route is very small and estimation of risk, via this route, may unnecessarily produce an unacceptable risk.

To estimate an intake, certain assumptions must be made about exposure events, exposure durations, and the corresponding assimilation of contaminants by the receptor. Exposure factors, have been generated by the scientific community and have undergone review by the USEPA. Regardless of the validity of these exposure factors, they have been derived from a range of values generated by studies of limited number of individuals. In all instances, values used in the risk assessment, scientific judgments, and conservative assumptions agree with those of the USEPA. Conservative assumptions designed not to underestimate daily intakes were employed throughout the BRA and should error conservatively, thus adequately protecting human health and allowing the establishment of reasonable clean-up goals.

7.7.3 Sampling Strategy Uncertainty

Soil represents a medium of direct contact exposure and often is the main source of contaminants released into other media. The soil sampling depth should be applicable for the exposure pathways and contaminant transport routes of concern and should be chosen purposely within that depth interval. If a depth interval is chosen purposely, a random sample procedure to select a sampling point may be established. The assessment of surface exposure at the site is certain based on collection of samples from the most shallow depth, zero to one foot. Subsurface soil samples are important, however, if soil disturbance is likely or leaching of chemicals to groundwater is of concern.

The surface soil samples at the site were obtained directly or very near the suspected disposal areas. Therefore, these areas would be considered areas of very high concentration which would have a significant impact on exposures. Because buried chemical agents may have been present, the subsurface soil investigation did not include extensive sampling. The subsurface soil concentrations used in determining construction workers exposures were derived from subsurface soils obtained from around the site or off-site. Consequently, the risk to future construction workers from ingestion, dermal contact, and inhalation with subsurface soils may be biased low. However, given the limited contaminants detected in the surface soil and groundwater, it does not appear as if additional subsurface soil sampling is needed.

7.7.4 Toxicity Assessment Uncertainty

In making quantitative estimates of the toxicity of varying doses of a compound to human receptors, uncertainties arise from two sources. First, data on human exposure and the subsequent effects are usually insufficient, if they are available at all. Human exposure data usually lack adequate

concentration estimations and suffer from inherent temporal variability. Therefore, animal studies are often used; and, therefore, new uncertainties arise from the process of extrapolating animal results to humans. Second, to obtain observable effects with a manageable number of experimental animals, high doses of a compound are used over a relatively short time period. In this situation, a high dose means that experimental animal exposures are much greater than human environmental exposures. Therefore, when applying the results of the animal experiment to humans, the effects at the high doses must be extrapolated to approximate effects at lower doses.

In extrapolating effects from animals to humans and high doses to low doses, scientific judgment and conservative assumptions are employed. In selecting animal studies for use in dose-response calculations, the following factors are considered:

- Studies are preferred where the animal closely mimics human pharmacokinetics
- Studies are preferred where dose intake most closely mimics the intake route and duration for humans
- Studies are preferred which demonstrate the most sensitive response to the compound in question

For compounds believed to cause threshold effects (i.e., noncarcinogens), safety factors are employed in the extrapolation of effects from animals to humans and from high to low doses.

The use of conservative assumptions results in quantitative indices of toxicity that are not expected to underestimate potential toxic effects, but may overestimate these effects by an order of magnitude or more.

7.8 Conclusions of the BRA for Site 1

The BRA highlights the media of interest from the human health standpoint at Site 1 by identifying areas which exceeded acceptable risk levels for the protection of human health. Current and future potential receptors at the site include current military personnel, future residents (i.e., children and adults), and future construction workers. The total risk from each site for these receptors was estimated by logically summing the multiple pathways likely to affect the receptor during a given activity. For the military and construction worker receptors, exposure to soil was evaluated. For the residential receptors, exposure to soil and groundwater was assessed.

The potential noncarcinogenic or carcinogenic risks from exposure to the surface soil and subsurface soil at Site 1 were within acceptable levels for the current military receptor and the future construction worker receptor, respectively.

There were potential noncarcinogenic and carcinogenic risks to the future residential child and adult receptors upon exposure to groundwater. The potential noncarcinogenic risks from groundwater are 17.8 and 7.6 for the child and adult receptor, respectively. These values exceed the acceptable level of one. The potential carcinogenic risk from groundwater was 1.8×10^{-4} for the adult receptor. This risk exceeds the range of 1×10^{-4} to 1×10^{-6} . Arsenic and manganese were the primary COPCs contributing to the risks.

As stated previously, the approach taken in this BRA is highly conservative. Site 1 is currently an active site which is used primarily for vehicle maintenance and equipment storage. The groundwater is not used for potable purposes. There are two supply wells located within a one-mile radius of the site, but the wells are no longer in service. Although a future residential scenario was evaluated for potential risk from potable groundwater use, the exposure scenario is highly conservative and unlikely to occur in the foreseeable future.

On comparison of arsenic and manganese levels in the groundwater to federal and state MCLs, only manganese exceeds the criteria (i.e., manganese exceeds the state MCL at a frequency of 5 out of 18). Arsenic did not exceed the federal or state level. Although these two metals contributed to the site risks, only one metal exceeded criteria. The concentration of arsenic that was used to determine potential risk was exceeded at five wells. Three of these wells were located off-site (i.e., wells 1-GW-10, 1-GW-11 and 1-GW-12). The concentration of manganese used to determine potential risk was the maximum level (1,200 µg/L) found at off-site well 1-GW-10. This level was found only once among the shallow and deep wells, excluding another off-site well, 1-GW-11, which had a concentration of 1,070 µg/L. The remaining manganese detections were at least a magnitude less than the maximum level. Although these two metals contributed to the site risks from groundwater exposure, the levels used to calculate risk were primarily from off-site wells, which either did not exceed criteria or exceeded criteria infrequently. Consequently, it is reasonable to assume that the risks from groundwater due to the presence of arsenic and manganese may be overestimates of risk and are highly conservative values.

SECTION 7.0 TABLES

TABLE 7-1

**SUMMARY OF STANDARDS/CRITERIA COMPARISON RESULTS FOR TOTAL METALS IN SURFACE SOIL
SITE 1, FRENCH CREEK LIQUIDS DISPOSAL AREA
REMEDIAL INVESTIGATION, CTO-0231
MCB, CAMP LEJEUNE, NORTH CAROLINA**

Parameter	Minimum Value (mg/kg)	Maximum Value (mg/kg)	Arithmetic Average (mg/kg)	No. of Times Detected	No. of Times Analyzed	Frequency of Detection	Twice Site Background Average (mg/kg)	No. Times Exceeds	USGS Background (mg/kg)	No. Times Exceeds
Aluminum	310.00	4490.00	2361.43	14	14	100%	4201.05	1/14	100000	0/14
Antimony	9.00	11.90	4.83	3	14	21%	4.81	3/14	9	3/14
Arsenic	0.57	2.00	0.69	6	14	43%	0.79	4/14	73	0/14
Barium	1.60	11.00	6.92	14	14	100%	13.61	0/14	1500	0/14
Beryllium	0.19	0.19	0.11	1	14	7%	0.22	0/14	7	0/14
Cadmium	0.62	2.00	0.51	3	14	21%	0.63	2/14	1	2/14
Calcium	47.50	40900.00	10614.47	13	14	93%	1064.06	9/14	280000	0/14
Chromium	1.50	6.40	4.12	13	14	93%	4.80	5/14	1000	0/14
Copper	1.60	4.90	1.60	6	14	43%	9.06	0/14	700	0/14
Iron	226.00	3060.00	1283.43	14	14	100%	2515.18	1/14	100000	0/14
Lead	1.00	23.50	9.44	14	14	100%	24.70	0/14	300	0/14
Magnesium	11.60	556.00	221.96	14	14	100%	170.30	8/14	50000	0/14
Manganese	3.10	16.40	8.02	14	14	100%	14.19	1/14	7000	0/14
Nickel	1.60	3.00	1.03	3	14	21%	3.11	0/14	700	0/14
Potassium	66.60	151.00	68.73	7	14	50%	155.30	0/14	37000	0/14
Sodium	40.30	138.00	26.77	2	14	14%	61.93	1/14	50000	0/14
Vanadium	1.00	8.50	4.28	14	14	100%	6.52	2/14	300	0/14
Zinc	3.50	26.90	9.03	9	14	64%	9.67	5/14	2900	0/14

Note: The data frequencies do not include rejected data. Consequently, these values may differ slightly from the frequencies presented in Appendix K.

TABLE 7-2

SUMMARY OF STANDARDS/CRITERIA COMPARISON RESULTS FOR TOTAL METALS IN SUBSURFACE SOIL
 SITE 1, FRENCH CREEK LIQUIDS DISPOSAL AREA
 REMEDIAL INVESTIGATION, CTO-0231
 MCB, CAMP LEJEUNE, NORTH CAROLINA

Parameter	Minimum Value (mg/kg)	Maximum Value (mg/kg)	Arithmetic Average (mg/kg)	No. of Times Detected	No. of Times Analyzed	Frequency of Detection	Twice Site Background Average (mg/kg)	No. Times Exceeds	USGS Background (mg/kg)	No. Times Exceeds
Aluminum	508.00	13700.00	4028.28	110	110	100%	6439.90	19/110	100000.0	0/110
Antimony	6.10	7.80	3.54	7	110	6%	7.54	3/110	8.8	0/110
Arsenic	0.60	5.60	1.04	58	110	53%	0.89	34/110	73.0	0/110
Barium	2.10	21.30	8.12	110	110	100%	11.06	23/110	1500.0	0/110
Cadmium	0.62	1.10	0.31	5	110	5%	0.62	5/110	1.0	1/110
Calcium	16.30	81300.00	7560.54	86	110	78%	118.75	71/110	280000.0	0/110
Chromium	1.50	17.50	6.19	109	110	99%	8.52	23/110	1000.0	0/110
Cobalt	0.64	1.30	0.45	13	110	12%	0.90	5/110	70.0	0/110
Copper	1.10	5.00	1.18	42	110	38%	2.46	9/110	700.0	0/110
Iron	112.00	9320.00	1928.51	110	110	100%	2373.67	31/110	100000.0	0/110
Lead	1.30	60.40	4.99	101	110	92%	5.84	20/110	300.0	0/110
Magnesium	9.40	1160.00	233.50	108	110	98%	209.74	39/110	50000.0	0/110
Manganese	0.26	61.30	6.52	108	110	98%	7.16	32/110	7000.0	0/110
Mercury	0.06	0.34	0.04	7	110	6%	0.19	5/110	3.4	0/110
Nickel	1.20	4.40	1.34	40	110	36%	2.06	20/110	700.0	0/110
Potassium	20.30	437.00	147.50	89	110	81%	241.18	18/110	37000.0	0/110
Selenium	0.81	1.50	0.39	2	110	2%	0.83	1/110	3.9	0/110
Silver	1.00	1.00	0.48	1	110	1%	1.03	0/110	5.0	0/110
Sodium	10.20	161.00	22.59	26	110	24%	30.76	7/110	50000.0	0/110
Vanadium	0.58	26.10	7.04	110	110	100%	9.54	24/110	300.0	0/110
Zinc	0.63	78.60	5.26	74	110	67%	3.70	25/110	2900.0	0/110

Note: The data frequencies do not include rejected data. Consequently, these values may differ slightly from the frequencies presented in Appendix K.

TABLE 7-3

SUMMARY OF STANDARDS/CRITERIA COMPARISON RESULTS FOR TOTAL METALS IN SHALLOW AND DEEP GROUNDWATER
 SITE 1, FRENCH CREEK LIQUIDS DISPOSAL AREA
 REMEDIAL INVESTIGATION, CTO-0231
 MCB, CAMP LEJEUNE, NORTH CAROLINA

Parameter	Minimum Value (µg/L)	Maximum Value (µg/L)	Arithmetic Average (µg/L)	No. of Times Detected	No. of Times Analyzed	Frequency of Detection	Federal MCL (µg/L)	No. Times Exceeds	State MCL (µg/L)	No. Times Exceeds	Federal Health Advisories (µg/L)			
											10 kg Child	No. Times Exceeds	70 kg Adult	No. Times Exceeds
Aluminum	416	1,510	271.31	6	18	33%	NA	NA	NA	NA	NA	NA	NA	NA
Arsenic	8.9	15.2	4.19	5	18	28%	50	0/18	50	0/18	NA	NA	NA	NA
Barium	7.9	76.6	32.44	18	18	100%	2000	0/18	2000	0/18	NA	NA	NA	NA
Calcium	900	137,000	51,107	18	18	100%	NA	NA	NA	NA	NA	NA	NA	NA
Cobalt	14.1	30.0	4.67	2	18	11%	NA	NA	NA	NA	NA	NA	NA	NA
Iron	263	29,200	5,789.25	9	18	50%	NA	NA	300	8/19	NA	NA	NA	NA
Lead	1.4	2.4	0.66	2	18	11%	15	0/18	15	0/18	NA	NA	NA	NA
Magnesium	550	7,090.0	3,147.50	18	18	100%	NA	NA	NA	NA	NA	NA	NA	NA
Manganese	2.5	1,200.0	187.67	14	18	78%	NA	NA	50	5/18	NA	NA	NA	NA
Mercury	0.14	1.2	0.27	11	14	79%	2	0/14	1.1	1/14	NA	NA	2	0/14
Potassium	305	5,180	1,367	18	18	100%	NA	NA	NA	0/19	NA	NA	NA	NA
Sodium	1,410	19,200	6,676	18	18	100%	NA	NA	NA	NA	NA	NA	NA	NA
Vanadium	3.6	11.4	2.17	2	18	11%	NA	NA	NA	NA	NA	NA	NA	NA

Note: The data frequencies do not include rejected data. Consequently, these values may differ slightly from the frequencies presented in Appendix K.

TABLE 7-4

SUMMARY OF STANDARDS/CRITERIA COMPARISON RESULTS FOR ORGANICS IN SHALLOW AND DEEP GROUNDWATER
 SITE 1, FRENCH CREEK LIQUIDS DISPOSAL AREA
 REMEDIAL INVESTIGATION, CTO-0231
 MCB, CAMP LEJEUNE, NORTH CAROLINA

Parameter	Minimum Value (µg/L)	Maximum Value (µg/L)	Arithmetic Average (µg/L)	No. of Times Detected	No. of Times Analyzed	Frequency of Detection	Federal MCL (µg/L)	No. Times Exceeds	State MCL (µg/L)	No. Times Exceeds	Federal Health Advisories (µg/L)			
											10 kg Child	No. Times Exceeds	70 kg Adult	No. Times Exceeds
Chloromethane	1	1	1.4	1	19	5%	NA	NA	NA	NA	NA	NA	NA	NA
Vinyl chloride	2	2	1.5	1	19	5%	2	1/18	0.015	1/18	10	0/18	50	0/18
1,2-Dichloroethene (total)	1	10	1.9	2	19	11%	NA	NA	70	0/18	NA	NA	NA	NA
Trichloroethene	1	27	2.9	3	19	16%	5	1/18	2.8	2/18	NA	NA	NA	NA
Xylene (total)	3	3	1.5	1	19	5%	10000	0/18	530	0/18	40000	0/18	1E+05	0/18
Phenol	6.1	6.1	5.1	1	19	11%	NA	NA	NA	NA	NA	NA	NA	NA
Diethylphthalate	1.3	1.3	4.8	1	19	11%	NA	NA	5000	0/18	NA	NA	NA	NA
Bis(2-ethylhexyl) phthalate	1	30	5.4	6	19	32%	6	1/19	NA	NA	NA	NA	NA	NA

Note: The data frequencies do not include rejected data. Consequently, these values may differ slightly from the frequencies presented in Appendix K.

TABLE 7-5

SUMMARY OF CONTAMINANTS OF POTENTIAL CONCERN (COPCs) SURFACE SOIL,
 SUBSURFACE SOIL, AND SHALLOW AND DEEP GROUNDWATER
 SITE 1, FRENCH CREEK LIQUIDS DISPOSAL AREA
 REMEDIAL INVESTIGATION, CTO-0231
 MCB, CAMP LEJEUNE, NORTH CAROLINA

COPCs Surface Soil	Excluded - Below RBCs	Excluded - Within Base-Wide Background Levels	Excluded - Essential Nutrients
aluminum (NA) antimony arsenic (c-Class A) cadmium chromium manganese vanadium zinc 4,4'-DDE (c-Class B2) 4,4'-DDT (c-Class B2)	Bis(2-ethylhexyl)phthalate dieldrin	barium beryllium copper lead (NA) nickel	calcium iron magnesium potassium sodium

Notes: (c) = Carcinogen and Class

(NA) = No USEPA-verified toxicological factors (i.e., RfDs and CSFs) available

TABLE 7-5 (Continued)

SUMMARY OF CONTAMINANTS OF POTENTIAL CONCERN (COPCs) SUBSURFACE SOIL,
 SUBSURFACE SOIL, AND SHALLOW AND DEEP GROUNDWATER
 SITE 1, FRENCH CREEK LIQUIDS DISPOSAL AREA
 REMEDIAL INVESTIGATION, CTO-0231
 MCB, CAMP LEJEUNE, NORTH CAROLINA

COPCs Subsurface	Excluded - Low Frequency of Detection or Below RBCs	Excluded - Within Base- Wide Background Levels	Excluded - Essential Nutrients
aluminum (NA) arsenic (c-Class A) barium cadmium chromium cobalt copper lead (NA) manganese nickel vanadium zinc BEHP (c-Class B2)	antimony mercury selenium silver acetone dieldrin 4,4'-DDE 4,4'-DDD 4,4'-DDT endosulfan II endrin aldehyde alpha-chlordane gamma-chlordane Aroclor-1254 Aroclor-1260	silver	calcium iron magnesium potassium sodium

Notes: (c) = Carcinogen and Class
 (NA) = No USEPA-verified toxicological factors (i.e., RfDs and CSFs) available

TABLE 7-5 (Continued)

SUMMARY OF CONTAMINANTS OF POTENTIAL CONCERN (COPCs) SURFACE SOIL,
 SUBSURFACE SOIL, AND SHALLOW AND DEEP GROUNDWATER
 SITE 1, FRENCH CREEK LIQUIDS DISPOSAL AREA
 REMEDIAL INVESTIGATION, CTO-0231
 MCB, CAMP LEJEUNE, NORTH CAROLINA

COPCs Shallow and Deep Groundwater	Excluded - Below Standards/Criteria or RBCs	Excluded - Essential Nutrients	Excluded - Common Laboratory Contaminant
arsenic (c-Class A) barium manganese mercury 1,2-dichloroethene (total) (1,2-DCE) trichloroethene (TCE) (c-Class B2)	aluminum cobalt lead vanadium phenol diethylphthalate chloromethane vinyl chloride xylene	calcium iron magnesium potassium sodium	acetone BEHP

Notes: (c) = Carcinogen and Class

(NA) = No USEPA-verified toxicological factors (i.e., RfDs and CSFs) available

TABLE 7-6

**SUMMARY OF EXPOSURE DOSE INPUT PARAMETERS
SITE 1, FRENCH CREEK LIQUIDS DISPOSAL AREA
REMEDIAL INVESTIGATION, CTO-0231
MCB, CAMP LEJEUNE, NORTH CAROLINA**

Input Parameter	Units	Receptor			
		Child	Adult	Military Personnel	Construction Worker
Soil (mg/kg)					
Ingestion Rate, IR	mg/d	200	100	100	480
Fraction Ingested, FI	unitless	1	1	1	1
Exposure Frequency, EF	d/y	350	350	250	90
Exposure Duration, ED	y	6	30	4	1
Surface Area, SA	cm ²	2300	5800	4,300	4300
Absorption Factor, AF	mg/cm ³	1	1	1	1
Averaging Time, Noncarc., ATnc	d	2190	10,950	1,460	365
Averaging Time, Carc., ATcarc	d	25550	25,550	25,550	25,550
Body Weight, BW	kg	15	70	70	70
Conversion Factor, CF	kg/mg	1x10 ⁻⁶	1x10 ⁻⁶	1x10 ⁻⁶	1x10 ⁻⁶
Absorbance Factor, ABS	unitless	Organics = 0.01; Inorganics = 0.001			
Groundwater (mg/L)					
Ingestion Rate, IR	L/d	1	2	NA	NA
Exposure Frequency, EF	d/y	350	350	NA	NA
Exposure Duration, ED	y	6	30	NA	NA
Exposure Time, ET	h/d	0.25	0.25	NA	NA
Surface Area, SA	cm ²	10000	23000	NA	NA
Averaging Time, Noncarc., ATnc	d	2,190	10,950	NA	NA
Averaging Time, Carc., ATcarc	d	25,550	25,550	NA	NA
Conversion Factor, CF	L/cm ³	0.001	0.001	NA	NA
Body Weight, BW	kg	15	70	NA	NA
Outdoor Air					
Inhalation Rate, IR	m ³ /d	10	20	30	20
Exposure Frequency, EF	d/y	350	350	250	90
Exposure Duration, ED	y	6	30	4	1
Averaging Time, Noncarc., ATnc	d	2,190	10,950	1,460	365
Averaging Time, Carc., ATcarc	d	25,550	25,550	25,550	25,550
Body Weight, BW	kg	15	70	70	70

TABLE 7-6 (Continued)
SUMMARY OF EXPOSURE DOSE INPUT PARAMETERS
SITE 1, FRENCH CREEK LIQUIDS DISPOSAL AREA
REMEDIAL INVESTIGATION, CTO-0231
MCB, CAMP LEJEUNE, NORTH CAROLINA

Input Parameter	Units	Receptor			
		Child	Adult	Military Personnel	Construction Worker
Shower Air					
Inhalation Rate, IR	m ³ /h	0.6	0.6	NA	NA
Exposure Time, ET	h/d	0.25	0.25	NA	NA
Exposure Frequency, EF	d/y	350	350	NA	NA
Exposure Duration, ED	y	6	30	NA	NA
Averaging Time, Noncarc., ATnc	d	2,190	10,950	NA	NA
Averaging Time, Carc., ATcarc	d	25,550	25,550	NA	NA
Body Weight, BW	kg	15	70	NA	NA

NA = Not Applicable

References:

USEPA Risk Assessment For Superfund Volume I. Human Health Manual (Part A) Interim Final, December, 1989

USEPA Exposure Factors Handbook, July, 1989

USEPA Risk Assessment For Superfund Volume I. Human Health Evaluation Manual Supplemental Guidance. "Standard Default Exposure Factors" Interim Final. March 25, 1991

USEPA Dermal Exposure Assessment: Principles and Applications. Interim Report. January, 1992

TABLE 7-7

**SUMMARY OF EXPOSURE PATHWAYS
SITE 1, FRENCH CREEK LIQUIDS DISPOSAL AREA
REMEDIAL INVESTIGATION, CTO-0231
MCB, CAMP LEJEUNE, NORTH CAROLINA**

Receptor	Exposure Pathway
Current Military Personnel	Surface soil ingestion, dermal contact and inhalation
Future Construction Worker	Subsurface soil ingestion , dermal contact and inhalation
Future Residential Adult and Child	Subsurface soil ingestion, dermal contact and inhalation
	Groundwater ingestion, dermal contact and inhalation

TABLE 7-8

SUMMARY OF HEALTH-BASED CRITERIA
 SITE 1, FRENCH CREEK LIQUIDS DISPOSAL AREA
 REMEDIAL INVESTIGATION, CTO-0231
 MCB, CAMP LEJEUNE, NORTH CAROLINA

COPCs	RfD (Oral) (mg/kg/d)	RfC (Inhal.) (mg/kg/d)	CSF (Oral) (mg/kg/d) ⁻¹	CSF (Inhal.) (mg/kg/d) ⁻¹	Weight-of- Evidence
VOLATILES					
1,2-Dichloroethene	9.0E-03	-	-	-	-
Trichloroethene	6.0E-03	-	1.1E-02	6.0E-03	B2 or C
SEMIVOLATILES					
Bis(2-ethylhexyl)phthalate	2.0E-02	-	1.4E-02	-	B2
METALS					
Aluminum	1.0	-	-	-	-
Antimony	4.0E-04	-	-	-	-
Arsenic	3.0E-04	-	1.8E+00	1.5E+01	A
Barium	7.0E-02	1.4E-04	-	-	-
Cadmium (water) (food/soil)	5.0E-04 1.0E-03	-	-	6.3E+00	B1
Chromium	1.0E+00	-	-	-	-
Cobalt	6.0E-02	-	-	-	-
Copper	3.7E-02	-	-	-	D
Lead	-	-	-	-	B2
Manganese (water) (food/soil)	5.0E-03 1.4E-01	1.4E-05	-	-	D
Mercury	3.0E-04	8.6E-05	-	-	D
Nickel	2.0E-02	-	-	-	-
Vanadium	7.0E-03	-	-	-	-
Zinc	3.0E-01	-	-	-	D
PESTICIDES					
4,4'-DDE	-	-	3.4E-01	-	B2
4,4'-DDT	5.0E-04	-	3.4E-01	3.4E-01	B2

- = Not applicable or available.

References:

- Integrated Risk Information System (IRIS, 1994)
- Health Effects Assessment Summary Table (HEAST, 1994)
- Region III Risk-Based Concentration Table, November, 1994

TABLE 7-9

SUMMARY OF DERMALLY-ADJUSTED HEALTH-BASED CRITERIA*
SITE 1, FRENCH CREEK LIQUIDS DISPOSAL AREA
REMEDIAL INVESTIGATION, CTO-0231
MCB, CAMP LEJEUNE, NORTH CAROLINA

COPCs	Oral RfD (Dermally Adjusted) (mg/kg/d)	Oral CSF (Dermally Adjusted) (mg/kg/d) ⁻¹	Weight-of- Evidence
VOLATILES			
1,2-Dichloroethene	7.20E-03	-	-
Trichloroethene	4.80E-03	1.38E-02	B2 or C
SEMIVOLATILES			
Bis(2-Ethylhexyl)phthalate	1.00E-02	2.80E-02	B2
METALS			
Aluminum	2.00E-01	-	-
Antimony	8.00E-05	-	-
Arsenic	6.00E-05	8.75E+00	A
Barium	1.40E-02	-	-
Cadmium (water) (food/soil)	1.00E-04 2.00E-04	-	B1
Chromium	2.00E-01	-	-
Cobalt	1.20E-02	-	-
Copper	7.42E-03	-	D
Lead	-	-	B2
Manganese (water) (food/soil)	1.00E-03 2.80E- 02	-	D
Mercury	6.00E-05	-	D
Nickel	4.00E-03	-	-
Vanadium	1.40E-03	-	-
Zinc	6.00E-02	-	D
PESTICIDES			
4,4'-DDE	-	6.80E-01	B2
4,4'-DDT	2.50E-04	6.80E-01	B2

- = Not applicable or available.

* = Only applicable to oral toxicity values and not inhalation toxicity values.

References:

Integrated Risk Information System (IRIS, 1994)

Health Effects Assessment Summary Table (HEAST, 1994)

Region III Risk-Based Concentration Table, November, 1994

TABLE 7-10

SUMMARY OF POTENTIAL RISKS
 SITE 1, FRENCH CREEK LIQUIDS DISPOSAL AREA
 REMEDIAL INVESTIGATION, CTO-0231
 MCB, CAMP LEJEUNE, NORTH CAROLINA

Exposure Pathway	Future Child		Future Adult		Current Military		Future Construction Worker	
	NC Risk	Carc Risk	NC Risk	Carc Risk	NC Risk	Carc Risk	NC Risk	Carc Risk
Soil Ingestion	1.3E-01	2.3E-06	1.4E-02	1.2E-06	2.4E-02	1.1E-07	2.5E-04	5.1E-08
Soil Dermal Contact	7.8E-03	1.4E-07	4.2E-03	3.7E-07	5.2E-03	2.3E-08	8.0E-04	2.3E-09
Soil Inhalation	7.5E-05	2.2E-10	3.8E-06	4.6E-10	NA	6.1E-11	9.7E-07	4.0E-12
total	1.4E-01	2.5E-06	1.9E-02	1.6E-06	2.9E-02	1.3E-07	1.1E-03	5.4E-08
Groundwater Ingestion	17.5	8.2E-05	7.5	1.8E-04	NA	NA	NA	NA
Groundwater Dermal Contact	2.2E-01	1.0E-06	1.1E-01	2.5E-06	NA	NA	NA	NA
Groundwater Inhalation	NA	1.2E-07	NA	9.9E-08	NA	NA	NA	NA
total	17.7	8.3E-05	7.6	1.8E-04	NA	NA	NA	NA
Total	17.8	8.6E-05	7.6	1.8E-04	2.9E-02	1.3E-07	1.1E-03	5.4E-08

Notes: NC = Noncarcinogenic risk (shaded areas indicate risk > "1")
 Carc = Carcinogenic Risk (shaded areas indicate risk > "1E-4")
 NA = Not Applicable

TABLE 7-11

**SUMMARY OF COPCs CONTRIBUTING TO RISKS
SITE 1, FRENCH CREEK LIQUIDS DISPOSAL AREA
REMEDIAL INVESTIGATION, CTO-0231
MCB, CAMP LEJEUNE, NORTH CAROLINA**

Medium of Concern	COPC
Groundwater	Arsenic (0.0085 mg/L) Manganese (1.2 mg/L)

SECTION 7.0 FIGURES

FIGURE 7-1

FLOWCHART OF POTENTIAL EXPOSURE PATHWAYS AND RECEPTORS
SITE 1: FRENCHS CREEK LIQUIDS DISPOSAL AREA

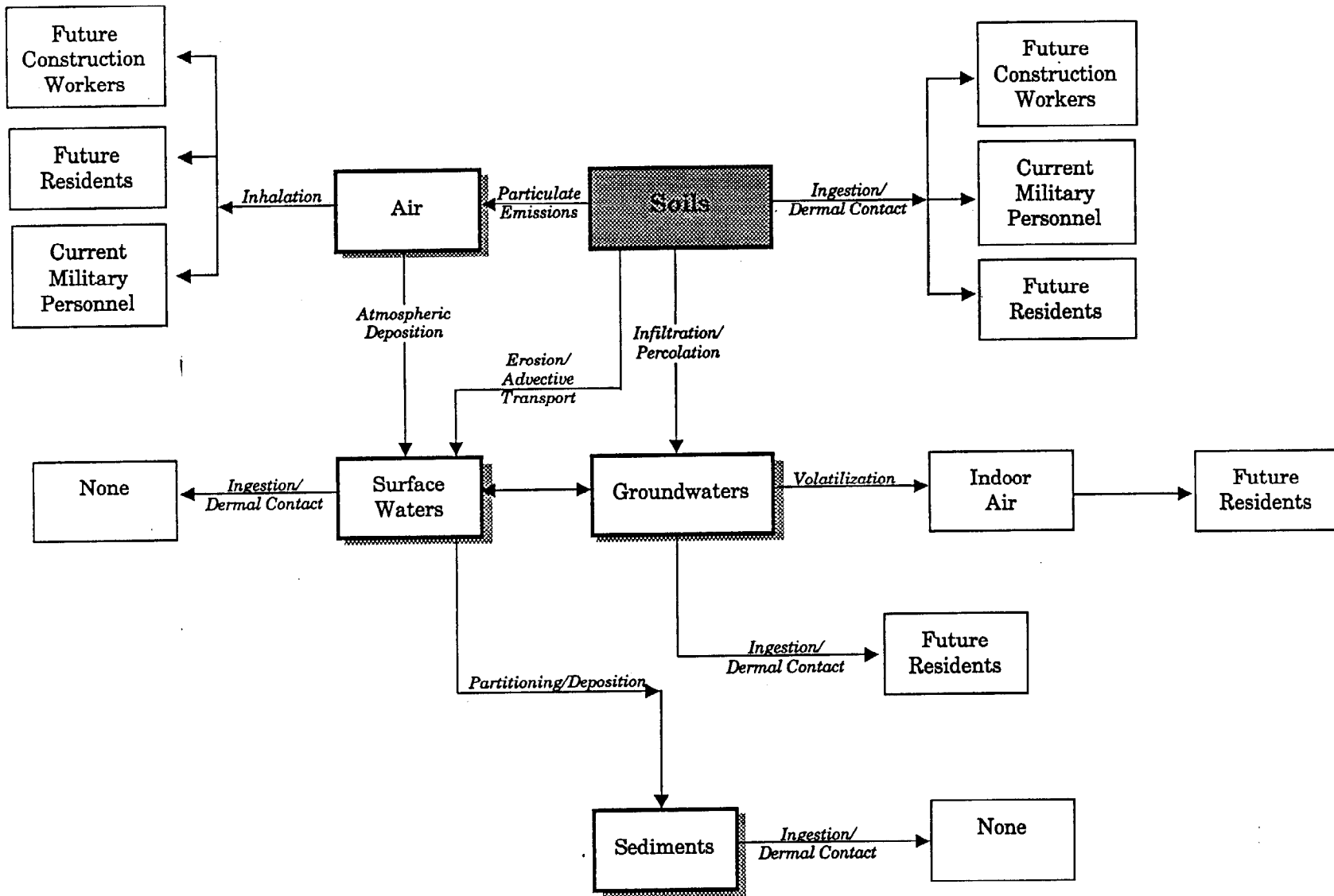

8.0 ECOLOGICAL RISK ASSESSMENT

8.1 Introduction

The Comprehensive Environmental Response, Compensation, and Liability Act of 1980 (CERCLA), as amended by the Superfund Amendments and Reauthorization Act (SARA) of 1986, directs USEPA to protect human health and the environment with respect to releases or potential releases of contaminants from abandoned hazardous waste sites (USEPA, 1989a). In addition, various Federal and state laws and regulations concerning environmental protection are considered standards/criteria or to be considered (TBC) criteria.

This section presents the ecological risk assessment (ERA) conducted at Site 1 in Operable Unit (OU) No. 7 that addresses the potential impacts to ecological receptors from site-related contaminants.

8.1.1 Objectives of the Ecological Risk Assessment

The objective of this ERA was to evaluate if past disposal practices at Site 1 could be adversely impacting the ecological integrity of the terrestrial and aquatic communities on, or adjacent to the site. This assessment also evaluated the potential effects of contaminants at Site 1 on sensitive environments including wetlands, protected species, and fish nursery areas. The conclusions of the ERA will be used in conjunction with the human health risk assessment to evaluate the appropriate remedial action for this site for the overall protection of public health and the environment.

8.1.2 Scope of the Ecological Risk Assessment

This ERA evaluated and analyzed the results from the RI and historical data collected during other studies. The RI included sampling and chemical analysis of the soil and groundwater at Site 1. Several environmental samples were collected from a drainage ditch during the investigation at Site 1. The samples were collected, however, to characterize a fuel spill which occurred during the investigation. Because the fuel spill is unrelated to past activities associated at Site 1, the data will not be included in the risk assessment. Evaluation of this data would provide a misrepresentation of true contaminant conditions associated with Site 1.

Information used to evaluate sensitive environments was obtained from historical data and previous studies conducted at Marine Corps Base (MCB) Camp Lejeune, North Carolina. In addition, a qualitative habitat evaluation was conducted at Site 1 to identify potential terrestrial receptors.

The medium of concern evaluated in this ERA was the surface soil. No aquatic receptors are present at Site 1; therefore, this ERA focused on adverse impacts to terrestrial receptors. If potential risks are characterized for the ecological receptors, further ecological evaluation of the site and surrounding areas may be warranted.

The risk assessment methodologies used in this evaluation were consistent with those outlined in the Framework for Ecological Risk Assessment (USEPA, 1992e). In addition, information found in the following documents was used to supplement the USEPA guidance document:

- U.S. EPA Supplemental Risk Assessment Guidance for Superfund, Volume II, Environmental Evaluation Manual (USEPA, 1989a)

- Ecological Assessment of Hazardous Waste Sites: A Field and Laboratory Reference (USEPA, 1989c)

8.1.3 Organization of The Ecological Risk Assessment

Based on the USEPA Framework for Ecological Risk Assessment, an ERA consists of three main components: (1) Problem Formulation, (2) Analysis, and (3) Risk Characterization (USEPA, 1992e). The problem formulation section (Section 8.2) includes a preliminary characterization of exposure and effects of the stressors to the ecological receptors. During the analysis (Section 8.3) the data are evaluated to determine the exposure and potential effects on the ecological receptors from the stressors. Finally, in the risk characterization (Section 8.4) the likelihood of adverse effects occurring as a result of exposure to a stressor is evaluated. Section 8.5 evaluates the potential impact on the ecological integrity at the site from the contaminants detected in the media. Section 8.6 presents an uncertainty analysis, while Section 8.7 summarizes the conclusions of the ERA.

8.2 Problem Formulation

Problem formulation is the first step of an ERA and includes a preliminary characterization of exposure and effects, as well as scientific data needs, policy and regulatory issues, and site-specific factors to define the feasibility, scope, and objectives for the ERA (USEPA, 1992e).

The results of the various site investigations indicated that contaminants are present in the soil and groundwater at Site 1. CERCLA directs USEPA to protect the environment from releases of contaminants. Because ecological receptors may be exposed to the contaminants detected at Site 1, an ERA was performed.

Three types of information are needed to evaluate potential links between the contaminants of potential concern (COPCs) and the ecological endpoints. First, chemical analyses of the appropriate media are necessary to establish the presence, concentrations, and variabilities of the COPCs. Second, ecological surveys are necessary to establish if adverse ecological effects have occurred. Finally, toxicological information is necessary to evaluate the potential effects of the COPCs on the ecological receptors. The combination of all three types of data allows the assessment of the relative contribution of other potential causes of the observed effects (as measured by the ecological endpoints) that may be unrelated to the toxic effects of the contaminants of concern (e.g., habitat alterations and natural variability). Therefore, confidence in cleanup and monitoring decisions is greatly enhanced when based on a combination of chemical, ecological, and toxicological data.

Chemical analyses were performed on samples collected from the soil and groundwater to evaluate the presence, concentrations, and variabilities of the COPCs. A qualitative habitat characterization also was conducted as part of Baker's field activities during the RI and was used to develop the biohabitat map (refer to Section 4.5). Based on these observations and available habitats information, potential ecological receptors were identified. Finally, toxicological information for the COPCs detected in the media was obtained from available references and literature and was used to evaluate the potential adverse ecological effects to the ecological receptors.

The components of the problem formulation include stressor characteristics, ecosystems potentially at risk, ecological effects, endpoint selection, and a conceptual model. The following sections discuss each of these components, and how they were evaluated in this ERA.

8.2.1 Stressor Characteristics

One of the initial steps in the problem formulation stage of an ERA is identifying the stressor characteristics. The term "stressor" is defined as any physical, chemical, or biological entity that can induce an adverse effect (USEPA, 1992e). For this ERA, the stressors that were evaluated include the contaminants detected in the surface soils. Contaminants in the subsurface soils and groundwater were not evaluated in this ERA.

The nature and extent of these contaminants were discussed in Section 5.0 of this report. Table 8-1 lists the contaminants that were detected in the surface soil at Site 1. The location of samples was based on historical information available for the site and a site visit to evaluate potential ecosystems and ecological receptors. Figures 3-1 and 3-2 illustrate these sample locations. Table 7-1 presents a comparison of the inorganics detected in the surface soil to twice the average base background concentrations.

8.2.1.1 Contaminants of Potential Concern (COPCs)

The COPCs for the ERA were selected following the same basic procedures and criteria used for selecting the COPCs for the Baseline Human Health Risk Assessment. However, COPCs will differ from those selected for the Human Health Risk Assessment. These differences can be the result of toxicity differences (some of the constituents detected may have a greater or lesser adverse impact to ecological receptors than to human receptors); and different criteria and standards used for ecological receptors.

Quantifying risk for all positively identified contaminants may distract from the dominant risks driving contaminants at the site. Ecological risks (and human health risks) are additive; including chemicals that are not significant, as determined by the COPC selection process, will generate an overestimate of risk. The chemical acting alone may not pose an adverse risk, but, in conjunction with the remaining chemicals, the chemical contributes to the total site risk. Consequently, to include all detected parameters without taking into account other factors, such as detection frequency, background contribution, and site history, would generate an overly conservative risk. Therefore, the data set was reduced to a list of COPCs. The criteria used in selecting the COPCs from the constituents detected during the field sampling and analytical phase of the investigation were: historical information; prevalence; mobility; persistence; toxicity; comparison to investigation-associated field and laboratory blank information; and comparison to background or naturally occurring levels. Table 8-2 presents the COPC selection summary.

COPCs - Surface Water

Surface water samples were to be collected from the drainage ditch at Site 1; however, the drainage ditch did not have any flowing water at the time of the sampling and only contained puddled water. Therefore, surface water samples were not collected at Site 1.

COPCs - Sediments

Sediment samples were collected from the drainage ditch at Site 1. However, as stated in Section 8.1.2, these samples will not be evaluated as part of the risk assessment.

COPCs - Biota Samples

Biota samples were not collected at Site 1.

COPCs - Surface Soils

Surface soil samples were collected at Site 1. The following pesticides detected in the surface soil samples were not addressed in the ERA because they were detected infrequently or they were detected at concentrations below soil screening levels: endrin aldehyde, 4,4'-DDE, and dieldrin. Bis(2-ethylhexyl)phthalate was not retained as a COPC because it was detected at concentrations below in the associated QA/QC blanks.

VOCs and PCBs were not detected in the surface soil at Site 1.

The following inorganics detected in the surface soil samples were not addressed in the ERA because they were common naturally occurring chemicals and were not expected to be ecological significant at the detected concentrations: calcium, magnesium, potassium, and sodium. Barium, copper, lead and nickel were not retained as COPCs because they were detected at concentrations within off-site background concentrations.

The following chemicals detected in the surface soil samples were addressed in the ERA because they could not be excluded based on the criteria stated above: 4,4'-DDT, aluminum, antimony, arsenic, barium, cadmium, chromium, copper, iron, lead, manganese, vanadium, and zinc.

8.2.1.2 Physical/Chemical Characteristics of COPCs

Physical and chemical characteristics of contaminants may affect their mobility, transport, and bioavailability in the environment. These characteristics include water solubility, organic carbon partition coefficient, octanol water partition coefficient, and vapor pressure. Table 8-3 summarizes these values for the COPCs identified in the surface soil samples for the site. Information from these tables was used in the risk characterization to assess the fate and transport of the constituents and the potential risks to the environmental receptors at each site. The following paragraphs discuss the significance of each parameter included in the table.

Water solubility is important in the ecological environment because it measures the tendency for a chemical to remain dissolved in the water column, partition to soil or sediment, or bioconcentrate in aquatic organisms. Chemicals with high water solubilities tend to be more bioavailable to aquatic organisms. However, they will not significantly bioconcentrate in the organisms. On the other hand, chemicals with a low water solubility will remain bound to the sediment and soils but may bioconcentrate in organisms to a significant degree.

The organic carbon partition coefficient (K_{oc}) measures the tendency for a chemical to partition between soil or sediment particles containing organic carbon and water. This coefficient is important in the ecological environment because it determines how strongly an organic chemical will be bound to the organic matter in the sediments.

The octanol/water partition coefficient (K_{ow}) is the ratio of a chemical concentration in octanol divided by the concentration in water. The octanol/water partition coefficient has been shown to correlate well with bioconcentration factors in aquatic organisms and with adsorption to soil or sediment. The log K_{ow} is presented in Table 8-3.

The vapor pressure measures the tendency for a chemical to partition into air. This parameter is important for the ecological environment because it can be used to determine the concentrations of the constituents in air.

8.2.2 Ecosystems Potentially at Risk

Based on the site-specific and regional ecology, several ecological receptors are potentially at risk from contaminants detected in the soil at the site (refer to Section 4.5 for site-specific and regional ecology). Potential receptors of contaminants in soils include deer, rabbits, foxes, birds, other fauna, and terrestrial flora.

8.2.3 Ecological Effects

The ecological effects data that were used to assess potential risks to terrestrial receptors at this site include terrestrial reference values.

A literature search was conducted to identify levels of contaminants in the soil that could cause adverse effects to terrestrial flora and invertebrates. However, these data cannot be used to evaluate potential risks to other terrestrial fauna (e.g., birds, deer, rabbits), since the exposure doses for these species are different than exposure doses for invertebrates and plants, which are in constant direct contact with the contaminants in the soil. In addition, the sensitivity of the organisms to the COPCs is not similar.

Terrestrial reference values (TRVs) for evaluating estimated chronic daily intakes (CDIs) of COPCs for the deer, quail, rabbit, and fox were calculated from available toxicity data. The TRVs were developed from No-Observed-Adverse-Effect-Levels (NOAELs) or Lowest-Observed-Adverse-Effect-Levels (LOAELs) obtained from the Integrated Risk Information System (IRIS), toxicological profiles for specific chemicals, and information from other reference books. These values were used to assess the potential effects of contaminants on terrestrial fauna.

8.2.4 Ecological Endpoints

The information compiled during the first stage of problem formulation (stressor characteristics, ecosystems potentially at risk, and ecological effects) was used to select the ecological endpoints for this ERA. The following section of this report contains a description of the ecological endpoints selected for this ERA and the reasons they were selected.

There are two primary types of ecological endpoints: assessment endpoints and measurement endpoints. Assessment endpoints are environmental characteristics, which, if they were found to be significantly affected, would indicate a need for remediation (e.g., decrease in sports/fisheries). Measurement endpoints are quantitative expressions of an observed or measured effect of the contaminant of concern. Measurement endpoints may be identical to assessment endpoints (e.g., measurement of abundance of organisms), or they may be used as surrogates for assessment endpoints (e.g., toxicity test endpoints).

8.2.4.1 Assessment Endpoints

Assessment endpoints are the ultimate focus of risk characterization and link the measurement endpoints to the risk management process (USEPA, 1992e). There are five criteria that an assessment endpoint should satisfy (Suter, 1993):

- Societal relevance
- Biological relevance
- Unambiguous operational definition
- Accessibility to prediction and measurement
- Susceptibility to the hazardous agent

Societal relevance is important because risk to ecological receptors of little intrinsic interest to the public (e.g., nematodes, zooplankton) is unlikely to influence decisions unless it can be shown to indicate risks to biota of direct human interest (e.g., wildlife) (Suter, 1993). The biological significance of a property is determined by its importance to a higher level of the biological hierarchy (Suter, 1993). The endpoint should be well defined and operational with a subject and a characteristic of the subject (USEPA, 1989d). The endpoint should be measurable (e.g., numbers of individuals) or predictable from measurements (e.g., toxicity tests). Finally, the endpoint must be susceptible to the contaminant being assessed. The assessment endpoint used in this ERA was decreased integrity of terrestrial floral and faunal communities.

Terrestrial organisms (e.g., rabbits, deer, fox, quail) are socially relevant because humans enjoy hunting and watching wildlife. Terrestrial organisms are also a food source for many people. The organisms are biologically relevant because they play a specific role in the natural community. The endpoint is defined with a subject (rabbits, deer, fox, and quail communities), and a characteristic of the subject (decreased integrity of rabbits, deer, fox, and quail). The TRVs can be used to predict risks to terrestrial organisms. Finally, terrestrial organisms are susceptible to the COPCs at Site 1. This is explained in Section 7.2.5, Site Conceptual Model.

8.2.4.2 Measurement Endpoints

A measurement endpoint, or "ecological effects indicator" as it is sometimes referred, is used to evaluate the assessment endpoint. Therefore, measurement endpoints must correspond to, or be predictive of, assessment endpoints. In addition, they must be readily measurable, preferably quickly and inexpensively, using existing techniques. Measurement endpoints must take into consideration the magnitude of the contamination and the exposure pathway. The measurement endpoint should be an indicator of effects that are temporally distributed. Low natural variability in the endpoint is preferred to aid in attributing the variability in the endpoint to the contaminant. Measurement endpoints should be diagnostic of the pollutants of interest, as well as broadly applicable to allow comparison among sites and regions. Also, measurement endpoints should be standardized (e.g., standard procedures for toxicity tests). Finally, it is desirable to use endpoints that already are being measured (if they exist) to determine baseline conditions.

Endpoints are divided into four primary ecological groups: individual, population, community, and ecosystem endpoints. Individual endpoints (e.g., death, growth, tissue concentrations) are evaluated through toxicity tests, models, and other methods used to assess the effects on individual organisms. Population endpoints (e.g., occurrence, abundance, reproductive performance) are evaluated to

determine presence and absence of species through field studies. Community endpoints (e.g., number of species, species diversity) are used to describe the complexity of the community. Finally, ecosystem endpoints (e.g., biomass, productivity, nutrient dynamics) are used to determine the effects between groups of organisms, and between organisms and the environment. Individual, population, and community endpoints were evaluated in this assessment.

The primary goal in deciding upon which ecological endpoints to evaluate was to determine the current effects that the contamination is having on the environment. The following section discusses the measurement endpoint that was chosen for the ERA.

Terrestrial Endpoints

As discussed earlier in this report, terrestrial faunal species inhabiting MCB Camp Lejeune including deer, birds, and small mammals, potentially could be exposed to the COPCs at Site 1. Potential effects from contaminants detected at Site 1 to these species were evaluated by comparing the CDIs to TRVs. In addition, comparisons of COPC concentrations in the soil to published plant and earthworm toxicity information were used to evaluate potential effects to some of these terrestrial species. The assessment and measurement endpoints for this ERA were the potential for individual effects caused by exceedences of TRVs and literature values.

8.2.5 The Conceptual Model

This section of the report contains a list of hypotheses regarding how the stressors might affect ecological components of the natural environment:

- Terrestrial receptors may be adversely affected by exposure to contaminants in the surface soil.
- Terrestrial receptors may be adversely affected by exposure to contaminated biota they ingest.

8.3 Analysis Phase

The next phase after the problem formulation is the analysis phase, which consists of the technical evaluation of the potential effects and exposure of the stressor on the ecological receptor. This phase includes the ecological exposure characterization and the ecological effects characterization.

8.3.1 Characterization of Exposure

Characterization of exposure evaluates the interaction of the stressor with the ecological component. The following sections characterize the exposure in accordance with the stressors, ecosystem, exposure analysis, and exposure profile.

8.3.1.1 Stressor Characterization: Distribution or Pattern of Change

The remedial investigations at Site 1 involved collecting samples from two media; soil and groundwater. The analytical results and source identification are discussed in Section 5.3 of this report. The extent of contamination is discussed in Section 5.4 of this report.

8.3.1.2 Ecosystem Characterization

The regional ecology of the coastal plain and the habitats present at Site 1 are presented in Section 1.2.6 of this report; information on sensitive environments and endangered species also is included. Site-specific ecology is presented in Section 4.5 of this report.

Site Description

Site 1 is located approximately one mile east of the New River and one mile southeast of the Hadnot Point Industrial Area on the Mainside portion of MCB Camp Lejeune (see Figure 1-1). The site is situated on both the north and south sides of Main Service Road near the western edge of the Gun Park Area and Force Troops Complex. The southern half of the site is bordered by Daly Road to the east and H.M. Smith Boulevard to the south. The total area of this site is estimated to be between seven and eight acres. Section 2.1 provides a detailed description of the site and surrounding areas.

8.3.1.3 Exposure Analysis/Profile

The next step in the characterization of exposure was to combine the spatial and temporal distributions of both the ecological component and the stressor to evaluate exposure. This section of the ERA addresses and quantifies each exposure pathway via soil, air, and groundwater.

To determine if ecological exposure via these pathways may occur in the absence of remedial actions, an analysis was conducted including the identification and characterization of the exposure pathways. The following four elements were examined to determine if a complete exposure pathway was present:

- A source and mechanism of chemical release
- An environmental transport medium
- A feasible receptor exposure route
- A receptor exposure point

Potential Exposure Scenarios

This section discusses the potential exposure scenarios at Site 1 including soil, groundwater, and air. Surface water and sediment were not present at Site 1, therefore they are not viable exposure pathways. The location of samples was based on historical information available for the site and a site visit to evaluate potential ecosystems and ecological receptors.

Soil Exposure Pathway

Potential release sources to be considered in evaluating the soil pathway are surface or buried wastes and contaminated soil. The release mechanisms to be considered are fugitive dust, leaching, tracking, and surface runoff. The transport medium is the soil. The potential routes to be considered for ecological exposure to the contaminated soils are ingestion and dermal contact. Potential exposure points for ecological receptors include species living in, or coming in contact with, the soils.

COPCs were detected in the surface soil, demonstrating a release from a source to the surface soil transport medium. Potential receptors that may be exposed to contaminants in surface soil at/or

around in the areas of detected COPCs included: deer, fox, rabbits, birds, plants, and other terrestrial life.

Terrestrial receptors potentially are exposed to contaminants in the soils through ingestion, dermal contact, and/or direct uptake (for flora). The magnitude of the exposure depends on their feeding habits and the amount of time they reside in the contaminated soils. In addition, terrestrial species may ingest organisms (e.g., insects, small mammals, plants) that have bioconcentrated contaminants from the soils. Potential decreased integrity of terrestrial receptors from contaminants in the surface soils is evaluated in this ERA by comparison of CDIs to TRVs and direct comparisons of soil concentrations to literature toxicity value for plants and invertebrates.

Groundwater Exposure Pathway

The potential release source to be considered in evaluating the groundwater pathway is contaminated soils. The release mechanism to be considered is leaching. The routes to be considered for ecological exposure to the contaminated groundwater are ingestion and dermal contact. Since organisms are not directly exposed to groundwater at Site 1, the groundwater exposure pathway will not be considered in this ERA.

Air Exposure Pathway

There are two potential release mechanisms to be considered in evaluating the atmospheric pathway: release of contaminated particulates and volatilization from surface soil and groundwater. The potential exposure points for receptors are areas on or adjacent to the site.

No data have been collected to document exposure to receptors via the air pathway. However, based on the low concentrations of VOCs detected in the soil, and the negligible vapor pressure of pesticides and metals, the air concentration of the COPCs is not expected to cause a decrease in integrity of the terrestrial receptors. Therefore, this pathway will not be evaluated as part of the ERA.

8.3.2 Ecological Effects Characterization

Potential ecological effects to terrestrial receptors were determined by comparison to literature values and by comparing the CDIs to TRVs. The following sections further discuss the CDI to TRV comparisons to evaluate the potential ecological effects to terrestrial receptors from the COPCs.

8.3.2.1 Surface Soil Quality

The amount of literature data evaluating adverse ecological effects on terrestrial species exposed to contaminants in surface soils is limited. However, toxicological effects on plants and/or invertebrates inhabiting contaminated soils were obtained from various studies in the literature for the following chemicals: arsenic, barium, cadmium, chromium, copper, lead, manganese, vanadium, and zinc. These data were used to evaluate decreased integrity of terrestrial flora and invertebrates from COPCs in the soil.

No toxicological effects of plants and/or invertebrates inhabiting contaminated soils were obtained from various studies in the literature for the following chemicals: aluminum, antimony, iron, and 4,4'-DDT. Therefore, these contaminants were not evaluated in the ERA. The following sections

present a comparison of the contaminants detected in the surface soils to the concentrations of the contaminants in soil that caused adverse effects to plants and terrestrial invertebrates.

Arsenic concentrations ranged from 0.57 to 3.6 mg/kg in the surface soils at Site 1, which are below the 25 mg/kg that depressed crop yields (USDI, 1988). Barium concentrations ranged from 1.6 to 14.2 mg/kg, which are below the 2,000 mg/kg that induced plant toxicity (Adriano, 1986). Cadmium concentrations ranged from 0.62 to 2.0 mg/kg, which are greater than the 0.5 mg/kg that has been shown to cause low toxicity in the earthworm species *Lumbricus rubellus* (Hopkin, 1989). Chromium concentrations found in the surface soils ranged from 1.5 to 13.1 mg/kg, some of which are greater than the 10 mg/kg in surface soils that caused mortality in the earthworm species *Pheretima pesthuma*. (Hopkin, 1989).

Copper concentrations ranged from 1.6 to 11.3 mg/kg, which are below the 50 mg/kg level that interfered with the reproduction activity of the earthworm species *Allolobophora caliginosa* (Hopkin, 1989). The phytotoxicity of lead was reported to be lower than that of copper (which would be greater than 50 mg/kg). Lead concentrations ranged from 1.0 to 89.2 mg/kg, which are less than the 670 mg/kg, which is considered hazardous to earthworms (Beyer, 1993). Manganese concentrations ranged from 0.85 to 16.4 mg/kg, which were less than the mean U.S. soil concentration of 560 mg/kg, and vanadium concentrations ranged from 1.0 to 20.7 mg/kg, which are lower than the mean U.S. soil concentration of 58 mg/kg (Adriano, 1986). Zinc concentrations ranged from 3.5 to 104 mg/kg, which are less than the 450 to 1400 mg/kg that caused plant toxicity (Adriano, 1986).

8.3.2.2 Terrestrial Chronic Daily Intake

A Chronic Daily Intake model was used to estimate the exposure to terrestrial receptors. The following describes the procedures used to evaluate the potential soil exposure to terrestrial fauna at Site 1 by both direct and indirect exposure to COPCs via soil and foodchain transfer.

Contaminants of potential concern at Site 1 are identified in Section 8.2.1.1 for each media. Based on the regional ecology and potential habitat at the site, the indicator species used in this analysis were the white-tailed deer, cottontail rabbit, red fox, and the bobwhite quail. The exposure points for these receptors were the surface soils and biota transfers. The routes for terrestrial exposure to the COPCs in the soil were incidental soil ingestion, ingestion of vegetation (leafy plants, seeds and berries) and ingestion of small mammals.

Total exposure of the terrestrial receptors to the COPCs in the soil was determined by estimating the Chronic Daily Intake (CDI) dose and comparing this dose to TRVs representing acceptable daily doses in mg/kg/day. For this analysis, TRVs were developed from NOAELs or LOAELs obtained from the Integrated Risk Information System (IRIS, 1993) or other toxicological data in the literature (see Table 8-4).

CDI Calculations

Total exposure of the terrestrial receptors at Site 1 to the COPCs in the soil was determined by estimating the CDI dose and comparing this dose to TRVs representing acceptable daily doses in mg/kg/day. CDIs were estimated for the white-tailed deer, cottontail rabbit, bobwhite quail, and red fox at Site 1. The estimated CDI dose of the receptors (bobwhite quail, cottontail rabbit, and white-tailed deer) to soils and vegetation was determined using the following equation:

$$CDI = \frac{(Cw)(Iw) + [(Cs)(Bv \text{ or } Br)(Iv) + (Cs)(Is)][H]}{BW}$$

Where:

CDI	=	Total Exposure, mg/kg/d
Cw	=	Constituent concentration in the water, mg/L
Iw	=	Rate of drinking water ingestion, L/d
Cs	=	Constituent concentration in soil, mg/kg
Bv	=	Soil to plant transfer coefficient (leaves, stems, straw, etc.), unitless
Br	=	Soil to plant transfer coefficient in soil (fruits, seeds, tubers, etc.), unitless
Iv	=	Rate of vegetation ingestion, kg/d
Is	=	Incidental soil ingestion, kg/d
H	=	Contaminated area/Home area range area ratio, unitless
BW	=	Body weight, kg

The estimated CDI dose of the red fox was determined using the following equation:

$$CDI = \frac{(Cw)(Iw) + [(Cs)(Br)(Iv) + (Cs)(Is) + (Cm)(Im)][H]}{BW}$$

where:

CDI	=	Total Exposure, mg/kg/d
Cw	=	Constituent concentration in the water, mg/L
Iw	=	Rate of drinking water ingestion, L/d
Br	=	Soil to plant transfer coefficient (fruit, seeds, tubers, etc.), unitless
Iv	=	Rate of vegetation ingestion, kg/d
Cs	=	Constituent concentration in soil, mg/kg
Is	=	Incidental soil ingestion, kg/d
Im	=	Rate of small mammal ingestion, kg/d
Cm	=	Constituent concentrations in small mammals, mg/kg
		where: $Cm = (Cs)(Bv) + (Cs)(Is)$
Bv	=	Soil to plant transfer coefficient (leaves, stems, straw, etc.), unitless
H	=	Contaminated area/Home area range area ratio, unitless
BW	=	Body weight, kg

Bioconcentration of the COPCs to plants was calculated using the soil to plant transfer coefficient (Bv or Br) for organics (Travis, 1988) and metals (Baes, 1984). Because there were no surface water samples collected at Site 1, the concentrations of the COPCs in the surface water were assumed to be zero. The concentrations of the COPCs in the soil (Cs) used in the model were the upper 95 percent confidence limit or the maximum concentration detected of each COPC at the site. The exposure parameters used in the CDI calculations are presented in Table 8-5 and are summarized for each receptor below.

For the white-tailed deer, the feeding rate is 1.6 kg/d (Dee, 1991). The deer's diet was assumed to be 100 percent vegetation (leaves, stems, straw). The incidental soil ingestion rate is 0.019 kg/d (Scarano, 1993). The rate of drinking water ingestion is 1.1 L/d (Dee, 1991). The rate of vegetation

ingestion is 1.6 kg/d. The body weight is 45.4 kg (Dee, 1991), and the home range is 454 acres (Dee, 1991).

For the eastern cottontail rabbit, the feeding rate is 0.1 kg/d (Newell, 1987). The rabbit's diet was assumed to be 100 percent vegetation (leaves, stems, straw). The incidental soil ingestion rate is 0.002 kg/d (Newell, 1987). The rate of drinking water ingestion is 0.119 L/d (USEPA, 1993d). The rate of vegetation ingestion is 0.1 kg/d. The body weight is 1.229 kg (USEPA, 1993d), and the home range is 9.29 acres (USEPA, 1993d).

For the bobwhite quail, the feeding rate is 0.014 kg/d (USEPA, 1993d). The quail's diet was assumed to be 100 percent vegetation (leaves, stems, straw). The incidental soil ingestion rate is 0.001 kg/d (Newell, 1987). The rate of drinking water ingestion is 0.019 L/d (USEPA, 1993d). The rate of vegetation ingestion is 0.014 kg/d. The body weight is 0.177 kg (USEPA, 1993d), and the home range is 8.89 acres (USEPA, 1993d).

For the red fox, the feeding rate is 0.446 kg/d (USEPA, 1993d). The fox's diet was assumed to be 20 percent vegetation (seed, berries) and 80 percent small mammals. The incidental soil ingestion rate is 0.012 kg/d (USEPA, 1993d). The rate of drinking water ingestion is 0.399 L/d (USEPA, 1993d). The rate of vegetation ingestion is 0.089 kg/d, the rate of small mammal ingestion is 0.356 kg/d. The body weight is 4.69 kg (USEPA, 1993d), and the home range is 1,771 acres (USEPA, 1993d).

8.4 Risk Characterization

The risk characterization is the final phase of a risk assessment. It is at this phase that the likelihood of adverse effects occurring as a result of exposure to a stressor is evaluated. This section evaluates the potential adverse effects on the ecological integrity at Site 1 from contaminants identified at the site.

8.4.1 Surface Soils

The concentrations of arsenic, barium, cadmium, chromium, copper, lead, manganese, vanadium, and zinc in the surface soil were compared to concentrations of these contaminants in soil that caused adverse effects to plants, terrestrial invertebrates, and terrestrial invertebrates. On comparison to these values, only the concentrations of cadmium and chromium were greater than the concentrations found to cause ecological effects in the literature.

8.4.2 Terrestrial Chronic Daily Intake Model

The following sections discuss the QIs calculated for the terrestrial receptors.

8.4.2.1 QI Calculations

A QI approach was used to characterize the risk to terrestrial receptors. Using the QI, the risks are characterized by comparing the CDIs for each COPC to the TRVs. The QI is calculated as follows:

$$QI = \frac{CDI}{TRV}$$

Where: QI = Quotient Index
CDI = Total Exposure, mg/kg/day (chronic daily intake)
TRV = Terrestrial Reference Value, mg/kg/day

Table 8-6 contains the QI for the COPCs in this area. A QI of greater than "unity" is considered to be indicative of potential risk. Such values do not necessarily indicate that an effect will occur but only that a lower threshold has been exceeded. The evaluation of the significance of the QI has been judged as follows: (Menzie et al., 1993)

- QI exceeds "1" but less than "10": some small potential for environmental effects.
- QI exceeds "10": significant potential that greater exposures could result in effects based on experimental evidence.
- QI exceeds "100": effects may be expected since this represents an exposure level at which effects have been observed in other species.

The risks characterized above provide insight into general effects upon animals in the local population. However, depending on the endpoint selected, they may not indicate if population-level effects will occur.

There are some differences of opinion found in the literature as to the effectiveness of using models to predict concentrations of contaminants found in terrestrial species. According to one source, the food chain models currently used incorporate simplistic assumptions that may not represent conditions at the site, bioavailability of contaminants, or site-specific behavior of the receptors. Simple food chain models can provide an effective means of initial characterization of risk; however, residue analyses, toxicity tests, and the use of biomarkers provide a better approach for assessing exposure (Menzie et al., 1993).

The CDI model was used to assess decreased integrity in terrestrial communities from exposure to contaminants in surface soils. A QI was calculated for each COPC and a total QI was calculated for each receptor at Site 1. TRVs could not be located for aluminum and iron. Therefore, these COPCs could not be included in this comparison.

At Site 1, the QIs were less than unity for all the COPCs except manganese. The QI for manganese was calculated to be 1.31 for the rabbit and 1.57 for the quail. Therefore, the total QI for both the rabbit and the quail was greater than one. However, because the QI was less than 2, this indicates a low potential for contaminants at Site 1 to adversely affect these animals.

8.4.3 Other Sensitive Environments

There were no threatened or endangered species or wetlands identified at Site 1. The potential impact to terrestrial organisms that are present at Site 1 is discussed in earlier sections of this report.

8.5 Ecological Significance

This section essentially summarizes the overall risks to the ecology at the site. It addresses impacts to the ecological integrity at Site 1 from the COPCs detected in the media and evaluates COPCs that are impacting the site to the greatest degree. This information, to be used in conjunction with the human health RA, supports the selection of remedial action(s) for Site 1 that are protective of public health and the environment.

8.5.1 Terrestrial Endpoints

During the habitat evaluation, no areas of vegetation stress or gross impacts from site contaminants were noted. The assessment endpoint used to assess the terrestrial environment is decreased integrity of terrestrial floral and faunal communities. Based on the soil toxicity data, for cadmium and chromium, concentrations of these contaminants at Site 1 may decrease the integrity of terrestrial invertebrates or plants at the site. However, because the site concentrations only slightly exceeded the literature values, it is not expected that these contaminants would present a significant ecological risk to these terrestrial receptors.

Terrestrial vertebrate receptors may be exposed to site COPCs in the surface soils by ingestion. The QI ratio only slightly exceeded unity because of effects of manganese on the rabbit and quail. However, based on the comparison of the CDIs to TRVs for the other site COPCs for the deer, rabbit, fox, and quail receptors used in this ERA, there does not appear to be a significant ecological risk to terrestrial vertebrate receptors.

8.5.2 Threatened and Endangered Species

There were no threatened or endangered species or critical habitats identified at Site 1. Therefore, there is no significant ecological risk to these receptors.

8.6 Uncertainty Analysis

The procedures used in this evaluation to assess risks to ecological receptors, as in all such assessments, are subject to uncertainties. The following discusses the uncertainty in the ERA.

The ecological investigation consisted of one sampling effort. The results of this sampling will only provide a "snapshot in time" of the ecological environment. Because the terrestrial community can have a high amount of natural variability, the "snapshot in time" may not be an accurate representation of actual site conditions. There also is error and uncertainty in the sampling methods used to collect the soil and groundwater samples.

There is uncertainty in the ecological endpoint comparison. The values used in the ecological endpoint comparison (TRVs) are set to be protective of a majority of the potential receptors. There will be some species, however, that will not be protected by the values because of their increased sensitivity to the chemicals. Also, the toxicity of chemical mixtures is not well understood. All the toxicity information used in the ecological risk assessment for evaluating risk is for individual chemicals. Chemical mixtures can affect the organisms very differently than the individual chemicals. In addition, there were several contaminants that did not have toxicity information. Therefore, potential effects to ecological receptors from these chemicals cannot be determined.

There is also uncertainty in the chronic daily intake models used to evaluate decreased integrity to terrestrial receptors. Many of the input parameters are based on default values (i.e., ingestion rate) that may or may not adequately represent the actual values of the parameters. In addition, there is uncertainty in the amount that the indicator species will represent other species potentially exposed to COPCs at the site. Finally, terrestrial species will also be exposed to contaminants by ingesting fauna that have accumulated contaminants. This additional exposure route was not evaluated in this ERA because of the high uncertainty associated with it.

8.7 Conclusions

Overall, metals appear to be the only site related COPCs that may have the potential to affect the integrity of the terrestrial receptors at Site 1. There were no aquatic receptors identified that would be exposed to site related COPCs.

Surface soil quality indicated a slight potential for cadmium and chromium concentrations to decrease the integrity of terrestrial invertebrates or plants at the site. However, because the site concentrations only just exceeded the literature values, it is not expected that these contaminants would present a significant ecological risk to these terrestrial receptors.

Other terrestrial receptors may be exposed to the contaminants in the surface soils by ingestion. Based on the comparison of the CDIs to TRVs for the deer, rabbit, fox, and quail used in this ERA, there does appear to be a slight ecological risk to terrestrial vertebrate receptors. However, this risk is expected to be low because the exceedances of the terrestrial reference values were at low levels.

There were no threatened or endangered species or critical habitat identified at Site 1. There is no ecological risk expected to these receptors.

SECTION 8.0 TABLES

TABLE 8-1

LIST OF CONTAMINANTS DETECTED IN THE SURFACE SOIL SAMPLES
SITE 1, FRENCH CREEK LIQUIDS DISPOSAL AREA
REMEDIAL INVESTIGATION, CTO-0231
MCB, CAMP LEJEUNE, NORTH CAROLINA

Analyte	Site 1 Surface Soil
Semivolatiles	
Bis(2-ethylhexyl)phthalate	X
Pesticides	
4,4'-DDE	X
4,4'-DDT	X
Dieldrin	X
Endrin aldehyde	X
Inorganics	
Aluminum	X
Antimony	X
Arsenic	X
Barium	X
Cadmium	X
Calcium	X
Chromium	X
Copper	X
Iron	X
Lead	X
Magnesium	X
Manganese	X
Nickel	X
Potassium	X
Sodium	X
Vanadium	X
Zinc	X

TABLE 8-2

SUMMARY OF CONTAMINANTS OF POTENTIAL CONCERN (COPCs) SURFACE SOIL
 SITE 1, FRENCH CREEK LIQUIDS DISPOSAL AREA
 REMEDIAL INVESTIGATION, CTO-0231
 MCB, CAMP LEJEUNE, NORTH CAROLINA

COPCs	Excluded - Low Frequency of Detection or Below Soil Screening Levels	Excluded - Within Off-Site Background Levels	Excluded - Essential Nutrients
aluminum antimony arsenic cadmium chromium iron manganese vanadium zinc 4,4'-DDT	dieldrin 4,4'-DDE endrin aldehyde	barium copper lead nickel bis(2-ethylhexyl)phthalate (common lab contaminant/blank contamination)	calcium magnesium potassium sodium

TABLE 8-3

**PHYSICAL/CHEMICAL CHARACTERISTICS OF THE COPCs
SITE 1, FRENCH CREEK LIQUIDS DISPOSAL AREA
REMEDIAL INVESTIGATION CTO-0231
MCB, CAMP LEJEUNE, NORTH CAROLINA**

Analyte	BCF (L/kg)	Water Solubility (mg/L)	Organic Carbon Partition Coefficient (mL/g)	Vapor Pressure (mm Hg)	Log Octanol/ Water Coefficient
Inorganics					
Aluminum	ND ^(1,3)	ND ^(1,3)	ND ⁽¹⁾	ND ^(1,3)	ND ^(1,3,4)
Antimony	1 ⁽⁵⁾	ND ^(1,3)	ND ⁽¹⁾	ND ^(1,2,3)	ND ^(1,3,4)
Arsenic	44 ⁽⁵⁾	ND ^(1,3)	ND ⁽¹⁾	ND ^(1,2,3)	ND ^(1,3,4)
Barium	ND ^(1,3)	ND ^(1,3)	ND ⁽¹⁾	ND ^(1,2,3)	ND ^(1,3,4)
Cadmium	64 ⁽⁵⁾	ND ^(1,3)	ND ⁽¹⁾	ND ^(1,2,3)	ND ^(1,3,4)
Chromium	16 ⁽⁵⁾	ND ^(1,3)	ND ⁽¹⁾	ND ^(1,2,3)	ND ^(1,3,4)
Copper	36 ⁽⁵⁾	ND ^(1,3)	ND ⁽¹⁾	ND ^(1,2,3)	ND ^(1,3,4)
Iron	ND ⁽⁵⁾	ND ^(1,3)	ND ⁽¹⁾	ND ^(1,3)	ND ^(1,3,4)
Lead	49 ⁽⁵⁾	ND ^(1,3)	ND ⁽¹⁾	ND ^(1,2,3)	ND ^(1,3,4)
Manganese	350,000 ⁽³⁾	ND ^(1,3)	ND ⁽¹⁾	ND ^(1,3)	ND ^(1,3,4)
Vanadium	ND ⁽³⁾	ND ^(1,3)	ND ⁽¹⁾	ND ⁽³⁾	ND ^(1,3,4)
Zinc	1 ⁽⁵⁾	ND ^(1,3)	ND ⁽¹⁾	ND ^(1,2,3)	ND ^(1,3,4)
Pesticides/PCBs					
4,4'-DDT	53,600 ⁽⁵⁾	0.025 ⁽³⁾	243,000 ⁽¹⁾	ND ^(1,2,3)	6.4 ⁽³⁾

- Notes: (1) USEPA, 1986.
 (2) Negligible (less than 0.1).
 (3) SCDM, 1991.
 (4) USEPA, 1985.
 (5) USEPA, 1993.
 (6) Howard, 1991.
- ND = No data
 BCF = Bioconcentration Factor
 VOCs = Volatile Organic Compounds
 SVOCs = Semivolatile Organic Compounds

TABLE 8-4

TERRESTRIAL REFERENCE VALUES AND SOIL TO PLANT TRANSFER COEFFICIENTS
 SITE 1, FRENCH CREEK LIQUIDS DISPOSAL AREA
 REMEDIAL INVESTIGATION, CTO-0231
 MCB, CAMP LEJEUNE, NORTH CAROLINA

Contaminant of Concern	Soil to Plant Transfer Coefficient (Bv)	Soil-to-Plant Concentration (Br)*	Terrestrial Reference Value (TRV) mg/kg/day
4,4'-DDT	0.008 ^(1,2)	0.008	0.05 ⁽⁵⁾
Aluminum	0.004 ⁽³⁾	0.00065 ⁽³⁾	NA
Antimony	0.2 ⁽³⁾	0.03 ⁽³⁾	0.35 ⁽⁴⁾
Arsenic	0.040 ⁽³⁾	0.006 ⁽³⁾	16 ⁽⁶⁾
Barium	0.150 ⁽³⁾	0.015 ⁽³⁾	30 ⁽⁵⁾
Cadmium	0.550 ⁽³⁾	0.150 ⁽³⁾	4.7 ⁽⁷⁾
Chromium	0.008 ⁽³⁾	0.005 ⁽³⁾	2.7 ⁽⁸⁾
Copper	0.400 ⁽³⁾	0.250 ⁽³⁾	300 ⁽⁵⁾
Iron	0.004 ⁽³⁾	0.001 ⁽³⁾	NA
Lead	0.045 ⁽³⁾	0.009 ⁽³⁾	27.4 ⁽⁵⁾
Manganese	0.250 ⁽³⁾	0.050 ⁽³⁾	0.14 ⁽⁹⁾
Vanadium	0.006 ⁽³⁾	0.003 ⁽³⁾	5 ⁽⁴⁾
Zinc	1.500 ⁽³⁾	0.900 ⁽³⁾	38 ⁽¹⁰⁾

NA - Information not available

* - Br is assumed to be the same as Bv for organics

- (1) Travis, 1988
- (2) USEPA, 1986
- (3) Baes, 1984
- (4) HEAST, 1993
- (5) IRIS, 1993
- (6) USDH, 1992
- (7) USDH, 1992a
- (8) USDH, 1991
- (9) IRIS, 1990
- (10) ATSDR, 1989

TABLE 8-5

TERRESTRIAL CHRONIC DAILY INTAKE MODEL EXPOSURE PARAMETERS
 SITE 1, FRENCH CREEK LIQUIDS DISPOSAL AREA
 REMEDIAL INVESTIGATION, CTO-0231
 MCB, CAMP LEJEUNE, NORTH CAROLINA

Exposure Parameter	Units	White-Tailed Deer	Eastern Cottontail Rabbit	Bobwhite Quail	Red Fox
Food Source Ingestion	NA	Vegetation 100%	Vegetation 100%	Vegetation 100%	Small Mammals 80% Vegetation 20%
Feeding Rate	kg/d	1.6 ⁽²⁾	0.1 ⁽³⁾	0.014 ⁽⁴⁾	0.446 ⁽⁴⁾
Incidental Soil Ingestion	kg/d	0.019 ⁽¹⁾	0.002 ⁽³⁾	0.001 ⁽³⁾	0.012 ⁽⁴⁾
Rate of Drinking Water Ingestion	L/d	1.1 ⁽²⁾	0.119 ⁽⁴⁾	0.019 ⁽⁴⁾	0.399 ⁽⁴⁾
Rate of Vegetation Ingestion	kg/d	1.6	0.1	0.014	0.089
Body Weight	kg	45.4 ⁽²⁾	1.229 ⁽⁴⁾	0.177 ⁽⁴⁾	4.69 ⁽⁴⁾
Rate of Small Mammal Ingestion	kg/d	NA	NA	NA	0.356
Home Range Size	acres	454 ⁽²⁾	9.29 ⁽⁴⁾	8.89 ⁽⁴⁾	1,771 ⁽⁴⁾

NA - Not Applicable

⁽¹⁾ Scarano, 1993

⁽²⁾ Dee, 1991

⁽³⁾ Newell, 1987

⁽⁴⁾ USEPA, 1993d

TABLE 8-6

**QUOTIENT INDEX RATIOS, TERRESTRIAL MODEL - SITE 1
REMEDIAL INVESTIGATION, CTO-0231
MCB CAMP LEJEUNE, NORTH CAROLINA**

Contaminant of Concern	Bobwhite Quail	Eastern Cottontail	Red Fox	Whitetailed Deer
4,4'-DDT	5.29E-04	1.83E-04	1.83E-06	1.13E-06
Aluminum	NA	NA	NA	NA
Antimony	3.19E-01	2.58E-01	1.45E-03	2.20E-03
Arsenic	5.13E-04	2.73E-04	1.98E-06	2.08E-06
Barium	4.91E-03	3.75E-03	2.17E-05	3.16E-05
Cadmium	6.18E-03	5.66E-03	3.09E-05	4.94E-05
Chromium	1.27E-02	4.36E-03	4.34E-05	2.68E-05
Copper	2.78E-04	2.47E-04	1.47E-06	2.15E-06
Iron	NA	NA	NA	NA
Lead	5.43E-03	3.00E-03	2.14E-05	2.32E-05
Manganese	1.57E+00	1.31E+00	7.37E-03	1.13E-02
Vanadium	6.30E-03	2.06E-03	2.12E-05	1.22E-05
Zinc	7.10E-02	6.86E-02	3.92E-04	6.05E-04
TOTAL	1.99E+00	1.66E+00	9.37E-03	1.42E-02

NA - Terrestrial reference value not available, therefore a quotient index ratio could not be calculated.

- QI exceeds "1" but less than "10": some small potential for environmental effects;
- QI exceeds "10": significant potential that greater exposures could result in effects based on experimental evidence;
- QI exceeds "100": effects may be expected since this represents an exposure level at which effects have been observed in other species. (Menzie *et al.*, 1993)

9.0 CONCLUSIONS AND SUMMARY

The following conclusions were derived from the RI conducted at Site 1:

- The soils underlying Site 1 are generally consistent throughout the shallow and deep subsurface. The soils consist of mostly silty sands with thinly interbedded layers of clay and silty clay which are discontinuous. One to two feet of fill material is present throughout the site, especially in areas where construction or regrading activities have occurred. The top of the River Bend Formation, which includes the upper portion of the Castle Hayne aquifer was encountered at approximately 25 to 27 feet bgs.
- The hydrogeologic characteristics of the study area were investigated by installing a network of shallow and deep monitoring wells. Groundwater flow within the surficial aquifer was determined to be to the west-northwest with a relatively low gradient of 0.0027. The groundwater flow direction within the deep aquifer was not determined due to a limited number of wells; however, it is expected to be to the west in the direction of the New River. Slightly different groundwater elevations (i.e., head differentials) were noted between the surficial and deep aquifer monitoring wells. In general, there is a downward movement (head) of groundwater at the site. Groundwater flow velocity within the surficial aquifer was estimated at 2.9×10^{-2} feet/day.
- Two water supply wells were identified within a one-mile radius of Site 1. Both wells, however, were put out of service by Activity personnel due to volatile organic compounds in the groundwater.
- The pesticides dieldrin, 4,4'-DDE, 4,4'-DDD, 4,4'-DDT, endrin aldehyde, alpha-chlordane, and gamma-chlordane appear to be the most prevalent contaminants within soils at Site 1. Each of the six pesticides were detected, at low concentrations, in at least two of the 124 soil samples. The pesticide 4,4'-DDT was the most prevalent, with 10 positive detections ranging from 1.6 J to 18 J $\mu\text{g}/\text{Kg}$. The highest pesticide concentration was that of 4,4'-DDE at 120 $\mu\text{g}/\text{Kg}$.
- Aroclor 1254 and 1260 were each detected once within the subsurface sample set. Aroclor 1254 was detected in a sample from a monitoring well test boring on the southern portion of the site, at a concentration of 18 J $\mu\text{g}/\text{Kg}$. Aroclor 1260 was identified at a concentration, 1,300 $\mu\text{g}/\text{Kg}$, in boring 1-N-SB35. This boring is located near the center of the northern disposal area.
- Volatile compounds were not found in surface soils and were detected in only four subsurface samples scattered throughout the site. Trichloroethene and toluene were detected at very low concentrations in samples also from the northern central portion of the study area.

- Semivolatile compounds were not encountered in surface soils, but were detected in a number of subsurface samples. Most notable among the SVOCs detected, were three PAH compounds and di-n-butylphthalate.
- Based on a comparison of base-specific background levels, positive detections of inorganics at Site 1 do not appear to be the result of past disposal practices.
- Inorganic elements were the most prevalent among potential contaminants in groundwater at Site 1 and were found distributed throughout the site. Concentrations of TAL total metals were generally higher in shallow groundwater samples than in samples obtained from the deeper aquifer. Iron and manganese were detected at concentrations which exceeded the NCWQS drinking water standards in nine and fifteen samples, respectively, obtained during the second sampling round. Barium, calcium, magnesium, potassium, and sodium were also detected in each of the shallow and deep groundwater samples.
- Positive detections of VOCs and SVOCs in groundwater were limited to the northern portion of the study area. In general, VOC analytical results from the first and second sampling events correlated. The volatile compound trichloroethene was detected in samples obtained from three of the shallow monitoring wells. The maximum trichloroethene concentration, 27 µg/L, was detected within the sample from monitoring well 1-GW17, located in the central northern portion of the study area. The volatile compounds 1,2-dichloroethene and 1,1-dichloroethene were observed at maximum concentrations of 21 and 2 J µg/L, respectively. The maximum 1,2-dichloroethene and 1,1-dichloroethene concentrations were detected in a sample obtained from well 1-GW10, located to the west of the suspected northern disposal area. Vinyl chloride was detected at an estimated concentration of 4 J µg/L, also from well 1-GW10. Xylenes were detected in a shallow groundwater sample from well 1-GW12, at a maximum concentration of 19 µg/L. The SVOCs phenol and diethylphthalate were detected during the first sampling round only in a sample from well 1-GW17DW, at concentrations of 6 J and 1 J µg/L, respectively.
- The potential noncarcinogenic or carcinogenic risks from exposure to the surface soil and subsurface soil at Site 1 were within acceptable levels for the current military receptor and the future construction worker receptor, respectively.
- There were potential noncarcinogenic and carcinogenic risks to the future residential child and adult receptors upon exposure to groundwater. The potential noncarcinogenic risks from groundwater are 17.8 and 7.6 for the child and adult receptor, respectively. These values exceed the acceptable level of one. The potential carcinogenic risk from groundwater was 1.8×10^{-4} for the adult receptor. This risk exceeds the acceptable risk range of 1×10^{-4} to 1×10^{-6} . Arsenic and manganese were the primary COPCs contributing to the risks.
- On comparison of arsenic and manganese levels in the groundwater to federal and state standards, only manganese exceeds the criteria (i.e., manganese exceeds the state standard at a frequency of 5 out of 18 samples). The concentration of arsenic that was used to determine potential risk was exceeded at five wells. Three of these

wells are located off site (i.e., wells 1-GW10, 1-GW11, and 1-GW12). The concentration of manganese used to determine potential risk was the maximum level (1,200 µg/L) found at off-site well 1-GW10. This level was found only once among the shallow and deep wells, excluding another off-site well, 1-GW11, which had a concentration of 1,070 µg/L. The remaining detects of manganese were at least a magnitude less than the maximum level. Although these two metals contributed to the site risks from groundwater exposure, the levels used to calculate risk were primarily from off-site wells. Consequently, it is reasonable to assume that the risks from groundwater due to the presence of arsenic and manganese may be overestimates of risk and are highly conservative values.

- Metals appear to be the only site related COPCs that may have the potential to affect the integrity of terrestrial receptors at Site 1. There were no aquatic receptors identified that would be exposed to site related COPCs. In addition, there were no threatened or endangered species or critical habitats identified at Site 1. Therefore, there is no ecological risk expected to these receptors.
- Surface soil quality indicated a slight potential for cadmium and chromium concentrations to decrease the integrity of terrestrial invertebrates or plants at the site. However, because the site concentrations only just exceeded the literature values, it is not expected that these contaminants would present a significant ecological risk to these terrestrial receptors.
- Other terrestrial receptors may be exposed to the contaminants in the surface soils by ingestion. Based on the comparison of the CDIs to TRVs for the deer, rabbit, fox, and quail receptors used in this ERA, there does appear to be a slight ecological risk to terrestrial vertebrate receptors. However, this risk is expected to be low because of the low level of the exceedances of the terrestrial reference values.