

03.13-08/22/96-01715

FINAL

**REMEDIAL INVESTIGATION REPORT
OPERABLE UNIT NO. 6**

(SITE 44)

**VOLUME VI
MARINE CORPS BASE
CAMP LEJEUNE, NORTH CAROLINA**

**CONTRACT TASK ORDER 0303
TEXT AND FIGURES**

AUGUST 22, 1996

Prepared For:

**DEPARTMENT OF THE NAVY
ATLANTIC DIVISION
NAVAL FACILITIES
ENGINEERING COMMAND
*Norfolk, Virginia***

Under:

**LANTDIV CLEAN Program
Contract N62470-89-D-4814**

Prepared by:

**BAKER ENVIRONMENTAL, INC.
*Coraopolis, Pennsylvania***

TABLE OF CONTENTS

	<u>Page</u>
EXECUTIVE SUMMARY	ES-1
1.0 INTRODUCTION	1-1
1.1 Report Organization	1-1
1.2 Background and Setting of MCB, Camp Lejeune	1-2
1.2.1 Location and Setting	1-2
1.2.2 History	1-2
1.2.3 Operable Unit Description	1-2
1.2.4 Topography	1-3
1.2.5 Surface Water Hydrology	1-3
1.2.6 Geology	1-3
1.2.7 Hydrogeology	1-4
1.2.8 Ecology	1-5
1.2.9 Land Use Demographics	1-9
1.2.10 Meteorology	1-10
1.3 Background and Setting of Site 44	1-10
1.3.1 Site Location and Setting	1-10
1.3.2 Site History	1-11
1.4 Previous Investigations	1-11
1.4.1 Initial Assessment Study	1-11
1.4.2 Site Inspection	1-11
1.5 Remedial Investigation Objectives	1-13
1.6 References	1-13
2.0 SITE CHARACTERISTICS	2-1
2.1 Topography and Surface Features	2-1
2.2 Surface Water Hydrology	2-1
2.3 Soil	2-1
2.4 Geology	2-1
2.5 Hydrogeology	2-3
2.5.1 Groundwater Elevation Data	2-3
2.5.2 Groundwater Flow Contour Maps	2-3
2.5.3 Hydraulic Properties	2-4
2.5.4 Groundwater Flow Velocities	2-5
2.5.5 General Groundwater Flow Patterns	2-5
2.6 Identification of Water Supply Wells	2-6
2.7 Ecology	2-6
2.8 References	2-8
3.0 STUDY AREA INVESTIGATIONS	3-1
3.1 Site Survey	3-1
3.2 Soil Investigation	3-1
3.2.1 Soil Sampling Procedures	3-2
3.2.2 Sampling Locations	3-3

TABLE OF CONTENTS
(Continued)

	<u>Page</u>
3.2.3	Exploratory Test Pits 3-3
3.2.4	Analytical Program 3-4
3.2.5	Quality Assurance and Quality Control 3-4
3.2.6	Air Monitoring and Field Screening 3-5
3.3	Groundwater Investigation 3-5
3.3.1	Monitoring Well Installation 3-6
3.3.2	Monitoring Well Development 3-7
3.3.3	Water Level Measurements 3-7
3.3.4	Aquifer Testing 3-8
3.3.5	Sampling Locations 3-8
3.3.6	Sampling Procedures 3-8
3.3.7	Analytical Program 3-9
3.3.8	Quality Assurance and Quality Control 3-9
3.3.9	Field Screening and Air Monitoring 3-9
3.4	Surface Water and Sediment Investigations 3-9
3.4.1	Sampling Locations 3-10
3.4.2	Sampling Procedures 3-10
3.4.3	Analytical Program 3-10
3.4.4	Quality Assurance and Quality Control 3-11
3.5	Ecological Investigation 3-11
3.6	Decontamination Procedures 3-11
3.7	Investigation Derived Waste (IDW) Handling 3-12
3.8	References 3-12
4.0	NATURE AND EXTENT OF CONTAMINATION 4-1
4.1	Data Quality 4-1
4.1.1	Data Management and Tracking 4-1
4.2	Non-Site Related Analytical Results 4-2
4.2.1	Laboratory Contaminants 4-2
4.2.2	Naturally-Occurring Inorganic Analytes 4-3
4.3	Analytical Results 4-5
4.3.1	Soil Investigation 4-5
4.3.2	Groundwater Investigation 4-7
4.3.3	Surface Water Investigation 4-9
4.3.4	Sediment Investigation 4-10
4.4	Extent of Contamination 4-12
4.4.1	Extent of Soil Contamination 4-12
4.4.2	Extent of Groundwater Contamination 4-13
4.4.3	Extent of Surface Water Contamination 4-14
4.4.4	Extent of Sediment Contamination 4-16
4.5	References 4-18

TABLE OF CONTENTS
(Continued)

	<u>Page</u>
5.0	CONTAMINANT FATE AND TRANSPORT 5-1
5.1	Chemical and Physical Properties Impacting Fate and Transport 5-1
5.2	Contaminant Transport Pathways 5-2
5.2.1	Windblown Dust 5-3
5.2.2	Leaching of Sediment Contaminants to Surface Water 5-3
5.2.3	Migration of Contaminants in Surface Water 5-3
5.2.4	Leaching of Soil Contaminants to Groundwater 5-4
5.2.5	Migration of Contaminants in Groundwater to Surface Water 5-4
5.3	Fate and Transport Summary 5-4
5.3.1	Volatile Organic Compounds (VOCs) 5-4
5.3.2	Semivolatile Organic Compounds (SVOCs) 5-5
5.3.3	Pesticides 5-6
5.3.4	Metals 5-6
5.4	References 5-7
6.0	BASELINE HUMAN HEALTH RISK ASSESSMENT 6-1
6.1	Introduction 6-1
6.2	Hazard Identification 6-2
6.2.1	Data Evaluation and Reduction 6-2
6.2.2	Identification of Data Suitable for Use in a Quantitative Risk Assessment 6-3
6.2.3	Criteria Used in Selection of COPCs 6-3
6.2.4	Contaminants of Potential Concern (COPCs) 6-8
6.3	Exposure Assessment 6-11
6.3.1	Potential Human Receptors and Adjacent Populations 6-11
6.3.2	Migration and Exposure Pathways 6-13
6.3.3	Quantification of Exposure 6-15
6.3.4	Calculation of Chronic Daily Intakes 6-17
6.4	Toxicity Assessment 6-27
6.4.1	Carcinogenic Slope Factor 6-28
6.4.2	Reference Dose 6-28
6.4.3	Lead 6-30
6.4.4	Dermal Adjustment of Toxicity Factors 6-30
6.5	Risk Characterization 6-30
6.5.1	Human Health Risks 6-31
6.6	Sources of Uncertainty 6-33
6.6.1	Analytical Data 6-33
6.6.2	Exposure Assessment 6-34
6.6.3	Sampling Strategy 6-35
6.6.4	Toxicity Assessment 6-35
6.7	Conclusions of the BRA for Site 44 6-36
6.7.1	Current Scenario 6-37
6.7.2	Future Scenario 6-37

TABLE OF CONTENTS
(Continued)

		<u>Page</u>
6.8	References	6-37
7.0	ECOLOGICAL RISK ASSESSMENT	7-1
7.1	Objectives, Scope, and Organization of the Ecological Risk Assessment ...	7-1
7.2	Problem Formulation	7-2
7.3	Contaminants of Potential Concern	7-2
	7.3.1 Criteria for Selecting Contaminants of Potential Concern	7-2
	7.3.2 Selection of Contaminants of Potential Concern	7-6
	7.3.3 Physical/Chemical Characteristics of COPCs	7-8
7.4	Ecosystems Potentially at Risk	7-9
7.5	Ecological Endpoints	7-9
	7.5.1 Aquatic Endpoints	7-10
	7.5.2 Terrestrial Endpoints	7-10
7.6	Conceptual Model	7-10
	7.6.1 Soil Exposure Pathway	7-10
	7.6.2 Groundwater Exposure Pathway	7-11
	7.6.3 Surface Water and Sediment Exposure Pathway	7-11
	7.6.4 Air Exposure Pathway	7-12
7.7	Exposure Assessment	7-12
	7.7.1 Surface Water, Sediment, and Bioassay Sampling	7-12
7.8	Ecological Effects Characterization	7-15
	7.8.1 Surface Water	7-15
	7.8.2 Sediment	7-16
	7.8.4 Surface Soil	7-16
	7.8.5 Terrestrial Chronic Daily Intake Model	7-16
7.9	Risk Characterization	7-18
	7.9.1 Surface Water	7-19
	7.9.2 Sediment	7-19
	7.9.3 Terrestrial Chronic Daily Intake Model	7-20
7.10	Ecological Significance	7-20
	7.10.1 Aquatic Receptors	7-20
	7.10.2 Terrestrial Receptors	7-21
	7.10.3 Threatened and Endangered Species	7-22
	7.10.4 Wetlands	7-22
7.11	Uncertainty Analysis	7-22
7.12	Conclusions	7-23
	7.12.1 Aquatic Receptors	7-23
	7.12.2 Terrestrial Receptors	7-24
7.13	References	7-25
8.0	CONCLUSIONS AND RECOMMENDATIONS	8-1
8.1	Conclusions	8-1
8.2	Recommendations	8-1

APPENDICES

A	Test Boring Records
B	Test Boring and Well Construction Records
C	Exploratory Test Pit Records
D	Chain-of-Custody Forms
E	Field Well Development Records
F	Investigation Derived Waste Summary and Recommendations
G	Sampling Summary
H	Data and Frequency Summaries
I	Statistical Summaries
J	Field Duplicate Summaries
K	QA/QC Sampling Summary
L	Grain Size and Permeability Analytical Results
M	Wet Chemistry Analytical Results
N	Aquifer Test Results
O	Aquifer Property Calculations
P	Base Background Analytical Results and Evaluation Report
Q	Shower Model
R	Site Conceptual Model
S	CDI Calculations
T	Field Data Sheets
U	White Oak River Basin Reference Stations
V	Screening Value and Quotient Index Calculations
W	Bioassay Testing Results
X	Terrestrial Reference Values and CDI Calculations

LIST OF TABLES

- ES-1 Summary of Site Contamination
 - 1-1 Geologic and Hydrogeologic Units of North Carolina's Coastal Plain
 - 1-2 Summary of Hydraulic Properties Unrelated Site Investigations
 - 1-3 Hydraulic Property Estimates of the Castle Hayne Aquifer
 - 1-4 Protected Species Within MCB, Camp Lejeune
 - 1-5 Land Utilization Within Developed Areas of MCB, Camp Lejeune
 - 1-6 Climatic Data Summary Marine Corps Air Station, New River
 - 1-7 Summary of Well Construction Details Site Inspection
 - 1-8 Detected Organic Contaminants in Soil Site Inspection
 - 1-9 Detected Inorganic Contaminants in Soil Site Inspection
 - 1-10 Groundwater Analytical Results Site Inspection
 - 1-11 Surface Water Analytical Results Site Inspection
 - 1-12 Sediment Sample Analytical Results Site Inspection
 - 1-13 Remedial Investigation Objectives Site 44, Jones Street Dump

- 2-1 Summary of Soil Physical Properties
- 2-2 Summary of Groundwater and Surface Water Elevations
- 2-3 Hydraulic Properties Summary
- 2-4 Summary of Potable Water Supply Wells Within a One-mile Radius

- 3-1 Soil Sampling Summary Test Borings
- 3-2 Soil Sampling Summary Monitoring Well Test Borings
- 3-3 Soil Sampling Summary Test Pit Excavation
- 3-4 Quality Assurance/Quality Control Sampling Program Soil Investigation
- 3-5 Summary of Well Construction Details
- 3-6 Summary of Water Level Measurements
- 3-7 Summary of Groundwater Field Parameters
- 3-8 Groundwater Sampling Summary
- 3-9 Quality Assurance/Quality Control Sampling Program Groundwater Investigation
- 3-10 Summary of Surface Water Field Parameters
- 3-11 Surface Water Sampling Summary
- 3-12 Quality Assurance/Quality Control Sampling Program Surface Water and Sediment Investigation

- 4-1 Summary of Rejected Data
- 4-2 Summary of Site Contamination
- 4-3 Surface Soil -Positive Detection Summary, TCL Organics
- 4-4 Surface Soil -Positive Detection Summary, TAL Metals
- 4-5 Subsurface Soil -Positive Detection Summary, TCL Organics
- 4-6 Subsurface Soil -Positive Detection Summary, TAL Metals
- 4-7 Groundwater -Positive Detection Summary, TCL Organics
- 4-8 Groundwater -Positive Detection Summary, TAL Metals
- 4-9 Groundwater -Positive Detection Summary, TAL Dissolved Metals
- 4-10 Surface Water -Positive Detection Summary, TCL Organics
- 4-11 Surface Water -Positive Detection Summary, Supplemental Sampling Event, TCL Organics
- 4-12 Surface Water -Positive Detection Summary, Inorganic Analytes

LIST OF TABLES (Continued)

- 4-13 Surface Water -Positive Detection Summary, TAL Dissolved Metals
- 4-14 Sediment -Positive Detection Summary, TCL Organics
- 4-15 Sediment -Positive Detection Summary, TAL Metals

- 5-1 Organic Physical and Chemical Properties
- 5-2 Relative Mobilities of Metals as a Function of Environmental Conditions (Eh, Ph)

- 6-1 Contaminants of Potential Concern Organics in Surface Soil
- 6-2 Contaminants of Potential Concern Inorganics in Surface Soil
- 6-3 Contaminants of Potential Concern Organics in Subsurface Soil
- 6-4 Contaminants of Potential Concern Inorganics in Subsurface Soil
- 6-5 Contaminants of Potential Concern in Groundwater
- 6-6 Contaminants of Potential Concern in Surface Water
- 6-7 Contaminants of Potential Concern in Sediment
- 6-8 Summary of Exposure Dose Input Parameters
- 6-9 Summary of Exposure Pathways
- 6-10 Summary of Health-Based Criteria
- 6-11 Summary of Dermal Adjusted Health-Based Criteria
- 6-12 Summary of Risks for the Military Receptor
- 6-13 Summary of Risks for the Child Trespasser
- 6-14 Summary of Risks for the Future Child Resident
- 6-15 Summary of Risks for the Adult Trespasser
- 6-16 Summary of Risks for the Future Adult Resident
- 6-17 Summary of Risks for the Construction Worker
- 6-18 Summary of Uncertainties in the Results of the Human Health Risk Assessment
- 6-19 Summary of Contaminants Contributing to Site Risks

- 7-1 Frequency and Range of Contaminant Detections Compared to Saltwater Surface Water Screening Values
- 7-2 Frequency and Range of Dissolved Metals Detections Compared to Saltwater Surface Water Screening Values
- 7-3 Frequency and Range of Contaminant Detections Compared to Saltwater Sediment Reference Values
- 7-4 Contaminants of Potential Concern in Each Media
- 7-5 Physical/Chemical Characteristics of the COPCs
- 7-6 Sampling Station Characterization Summary
- 7-7 Field Chemistry Data
- 7-8 Frequency and Range of Contaminant Detections Compared to Soil Flora and Fauna Screening Values
- 7-9 Exposure Factors for Terrestrial Chronic Daily Intake Model
- 7-10 Surface Water Quotient Index
- 7-11 Sediment Quotient Index
- 7-12 Terrestrial Intake Model Quotient Index

LIST OF FIGURES

- 1-1 Operable Unit No. 6 - Sites 36, 43, 44, 54, and 86
- 1-2 Operable Units and Site Locations
- 1-3 Locations of Hydrogeologic Cross-Sections
- 1-4 Hydrogeologic Cross-Sections
- 1-5 Site Map, Site 44 - Jones Street Dump
- 1-6 Site Inspection Sampling Locations

- 2-1 Cross-section Location and Approximate Surface Elevation Map
- 2-2 Geologic Cross-sections A-A' through E'E'
- 2-3A Groundwater Elevation Trends
- 2-3B Groundwater Elevation Trends
- 2-4 Surficial Groundwater Contour Map
- 2-5 Deep Groundwater Contour Map
- 2-6 Potable Water supply Wells within a One-Mile Radius
- 2-7 Biohabitat Map

- 3-1 Soil Sampling Locations
- 3-2 Monitoring Well Locations
- 3-3 Typical Shallow Type II Groundwater Monitoring Well Construction Diagram
- 3-4 Typical Deep Type III Groundwater Monitoring Well Construction Diagram
- 3-5 Surface Water and Sediment Sampling Locations

- 4-1 Organic Compounds in Surface Soil
- 4-2 Organic Compounds in Subsurface Soil
- 4-3 Selected TAL Metals in Surface Soil
- 4-4 Selected TAL Metals in Subsurface Soil
- 4-5 Organic Compounds in Groundwater
- 4-6 TAL Metals in Groundwater Above Screening Standards
- 4-7 Sampling and Site Location Map
- 4-8 Organic Compounds in Surface Water
- 4-9 Organic Compounds in Sediment
- 4-10 TAL Metals in Sediment Above Screening Values

- 6-1 Flowchart of Potential Exposure Pathways and Receptors

- 7-1 Flowchart of Potential Exposure Pathways and Ecological Receptors
- 7-2 Quotient Indices that Exceeded "1" in Surface Water and Sediment

LIST OF ACRONYMS AND ABBREVIATIONS

AET	Apparent Effects Threshold
AQUIRE	Aquatic Information Retrieval Database
ARAR	Applicable or Relevant and Appropriate Requirement
AST	Above Ground Storage Tank
ASTM	American Society for Testing and Materials
ATSDR	Agency for Toxic Substances and Disease Registry
AWQC	Ambient Water Quality Criteria
BaB	Baymeade
Baker	Baker Environmental, Incorporated
Bb	Beef Biotransfer Factor
BCF	Bioconcentration Factor
BEHP	Bis(2-ethylhexyl)phthalate
bgs	Below Ground Surface
BI	Biotic Index
Br	Plant Biotransfer Factor (fruit)
BRA	Baseline Human Health Risk Assessment
BTEX	Benzene, Toluene, Ethylbenzene, and Xylene
Bv	Plant Biotransfer Factor (leaf)
°C	Degrees Celsius
Carc.	Carcinogenic Effects
CDI	Chronic Daily Intake
CERCLA	Comprehensive Environmental Response, Compensation and Liability Act
CLEJ	Camp Lejeune
CLP	Contract Laboratory Program
COC	Contaminant of Concern
COPC	Contaminant of Potential Concern
CRAVE	Carcinogen Risk Assessment Verification Endeavor
CRDL	Contract Required Detection Limit
CRQL	Contract Required Quantitation Limit
CSF	Carcinogenic Slope Factor
DC	Direct Current
DEM	Division of Environmental Management
DO	Dissolved Oxygen
DOD	Department of the Defense
DoN	Department of the Navy
DQO	Data Quality Objective
EDB	Ethyl Dibromide
EMD	Environmental Management Division (Camp Lejeune)
EPIC	Environmental Photographic Interpretation Center
ER-L	Effects Range - Low
ER-M	Effects Range - Median
ERA	Ecological Risk Assessment
ESE	Environmental Science and Engineering

LIST OF ACRONYMS AND ABBREVIATIONS
(Continued)

°F	Degrees Fahrenheit
FFA	Federal Facilities Agreement
FID	Flame Ionization Detector
ft	Feet
FWS	Fish and Wildlife Service
gpm	Gallons per Minute
GW	Groundwater Well
H'	Species Diversity (Shannon-Wiener)
H	Species Diversity (Brillouins')
HA	Health Advisories
HEAST	Health Effects Assessment Summary Tables
HHAG	Human Health Assessment Group
HI	Hazard Index
HPIA	Hadnot Point Industrial Area
HQ	Hazard Quotient
IAS	Initial Assessment Study
ICR	Estimated Incremental Lifetime Cancer Risk
ID	Internal Diameter
IDW	Investigation Derived Waste
IRIS	Integrated Risk Information System
IRP	Installation Restoration Program
K _{oc}	Organic Carbon Partition Coefficient
K _{ow}	Octanol Water Partition Coefficient
LANTDIV	Naval Facilities Engineering Command, Atlantic Division
LOAEL	Lowest-Observed-Adverse-Effect-Level
MAG	Marine Air Groups
MBI	Macroinvertebrate Biotic Index
MCAS	Marine Corps Air Station
MCB	Marine Corps Base
MCL	Maximum Contaminant Level
MEK	Methyl Ethyl Ketone
MF	Modifying Factor
mg/L	Milligrams per Liter
mg/kg	Milligrams per Kilogram
MI	Mobility Index
MIBK	Methyl Isobutyl Ketone
MS/MSD	Matrix Spike and Matrix Spike Duplicate
msl	Mean Sea Level

LIST OF ACRONYMS AND ABBREVIATIONS
(Continued)

NC DEHNR	North Carolina Department of Environment, Health, and Natural Resources
NCP	National Contingency Plan
NCWQS	North Carolina Water Quality Standards
ND	Nondetect
NEESA	Naval Energy and Environmental Support Activity
NEHC	Navy Environmental Health Center
NFESC	Naval Facilities Engineering Service Center
NOAA	National Oceanic and Atmospheric Administration
NOAEL	No-Observed-Adverse-Effect-Level
NOEL	No-Observed-Effect Level
Noncarc.	Noncarcinogenic Effects
NPL	National Priorities List
NWI	National Wetlands Inventory
O&G	Oil and Grease
ORNL	Oak Ridge National Laboratory
OSWER	Office of Solid Waste and Emergency Response
OU	Operable Unit
PAH	Polynuclear Aromatic Hydrocarbon
PCB	Polychlorinated Biphenyl
PID	Photoionization Detector
ppb	Parts per Billion
ppm	Parts per Million
PVC	Polyvinyl Chloride
QA/QC	Quality Assurance/Quality Control
QI	Quotient Index
R	Retardation Factor
RA	Risk Assessment
RBC	Region III Risk-Based Concentration
RCRA	Resource Conservation and Recovery Act
RfD	Reference Dose
RI/FS	Remedial Investigation/Feasibility Study
RI	Remedial Investigation
RME	Reasonable Maximum Exposure
ROD	Record of Decision
S	Solubility
SA	Site Assessment
SAP	Sampling and Analysis Plan
SCS	Soil Conservation Service
SD	Sediment
SI	Suite Investigation
Sj	Jaccard Coefficient

LIST OF ACRONYMS AND ABBREVIATIONS
(Continued)

SM-SP	Fine Sand and Loamy Fine Sand
SMCL	Secondary Maximum Contaminant Level
SOP	Standard Operating Procedure
SQC	Sediment Quality Criteria
S _s	Sφrenson Index
SSL	Sediment Screening Level
SSV	Sediment Screening Value
SSSV	Surface Soil Screening Value
STP	Sewage Treatment Plant
SU	Standard Unit
SVOC	Semivolatile Organic Compound
SW	Surface Water
SWSV	Surface Water Screening Value
TAL	Target Analyte List
TBC	To Be Considered
TCE	Trichloroethylene
TCL	Target Compound List
TCLP	Toxicity Characteristic Leaching Procedure
TDS	Total Dissolved Solids
TIC	Tentatively Identified Compound
TOC	Total Organic Carbon
TOC	Top-of-Casing
TPH	Total Petroleum Hydrocarbon
TRV	Terrestrial Reference Value
TSS	Total Suspended Solids
μg/L	Micrograms per Liter
μg/g	Micrograms per Gram
μg/kg	Micrograms per Kilogram
UBK	Uptake/Biokinetics
UCL	Upper Confidence Limit
UF	Uncertainty Factor
USCS	Unified Soil Classification System
USEPA	United States Environmental Protection Agency
USGS	United States Geological Survey
UST	Underground Storage Tank
VOC	Volatile Organic Compound
VP	Vapor Pressure
WAR	Water and Air Research, Incorporated
WOE	Weight-of-Evidence
WQS	Water Quality Standards
WQSV	Water Quality Screening Values

EXECUTIVE SUMMARY

INTRODUCTION

The purpose of an RI is to evaluate the nature and extent of the threat to public health and the environment caused by the release or threatened release of hazardous substances, pollutants, or contaminants. This RI investigation was conducted through the sampling of several environmental media (soil, groundwater, surface water, sediment, and fish tissue) at OU No. 6, evaluating the resultant analytical data, and performing a human health risk assessment (RA) and ecological RA. This RI report contains the results of all field investigations, the human health RA, and the ecological RA. Furthermore, the RI report provides information to support the FS and Record of Decision (ROD) documents.

Operable Unit Description

OU No. 6 is located within the northwest portion of the facility, to the south and east of Camp Geiger Development Area. Site 36 is referred to as the "Camp Geiger Area Dump," Site 43 is the "Agan Street Dump," Site 44 is known as the "Jones Street Dump," Site 54 is the "Crash Crew Fire Training Burn Pit," and Site 86 is known as the "Tank Area AS419-AS421 at MCAS."

Site Description and History

The Jones Street Dump (Site 44) encompasses approximately 5 acres and is situated within the operations area of MCAS New River. Vehicle access to the site is via Baxter Street, from Curtis Road. Site 44 is located at the northern terminus of Baxter Street, behind base housing units along Jones Street.

The site is partially surrounded by a six-foot cyclone fence, a portion of the site lies to the east of the fenced compound. The site is bordered to the north and west by Edwards Creek, to the south by base housing units along Jones Street, and to the east by woods and an unnamed tributary to Edwards Creek. Edwards Creek flows east from the study area toward Site 43, which is located about 2,000 feet to the east of Site 44.

A majority of the site is comprised of a gently dipping open field that slopes toward Edwards Creek. The field is covered with high grass, weeds, and small pine trees that are less than two inches in diameter. Surrounding the open field is a mature wooded area with dense understory.

Site 44 was reportedly in operation during the 1950s. Although the quantity of waste is not known, the IAS report stated that debris, cloth, lumber, and paint cans were disposed of at the site (WAR, 1983). The IAS report also referred to minor quantities of potentially hazardous waste as having been disposed of at Site 44, however, the report made no mention of what type of waste that included.

GEOLOGY

A depositional sequence was observed in the deep well borings at Site 44 that matches the sequence discussed in the U.S. Geological Survey's hydrogeologic assessment of Camp Lejeune (Cardinell, et al., 1993). The uppermost formation at Site 44 is the undifferentiated formation. The Belgrade Formation lies below, with the River Bend Formation below that.

The undifferentiated formation, typically consists of three units of Holocene and Pleistocene ages. The upper unit is 3 to 8 feet thick and predominantly consists of silt and clay layers that are medium stiff to very stiff. The middle unit is predominantly a fine sand with lesser amounts of silt and clay, and is loose to medium dense. This unit is approximately 12 to 14 feet thick. The lower unit is generally a fine to medium sand and shell fragments with lesser amounts of silt, or a clayey silt and shell fragments. These sediments are typically medium dense to very dense, and are approximately 30 feet thick. The undifferentiated formation typically extends to a depth between 45 and 50 feet bgs.

The Belgrade Formation, is predominantly a fine sand and clayey silt of the Miocene age. The top of this Formation lies 45 to 50 feet bgs, is approximately 5 feet thick, and has a distinct green or greenish-gray color. These sediments are typically medium dense to dense.

The River Bend Formation is predominantly a fine to medium sand with lesser amounts of silt and clay of the Oligocene age. This Formation lies 52 to 57 feet bgs at Site 44. The sediments of this formation are typically medium dense to dense.

HYDROGEOLOGY

There are several aquifers beneath Site 44 and vicinity. The upper two aquifers were investigated in this study, namely the surficial and Castle Hayne aquifers. The surficial aquifer occurs within the sediments of the undifferentiated formation. The surficial aquifer, which is under unconfined conditions (i.e., water table aquifer), typically lies within 10 feet of the surface, and is approximately 43 feet thick in the vicinity of Site 44. The upper portion of the Castle Hayne aquifer lies within the sediments of the River Bend Formation. The Castle Hayne aquifer lies 52 to 57 feet bgs, and is approximately 200 feet thick in the vicinity of Camp Gieger and the Air Station (Cardinell et al., 1993). The Belgrade Formation, situated between the Undifferentiated and River Bend Formations is also known as the Castle Hayne confining unit. The Castle Hayne confining unit is approximately 5 feet thick in the vicinity of Site 44.

The surficial aquifer hydraulic conductivity values are an order of magnitude lower than the value presented in the Cardinell's report. The average hydraulic conductivity at Site 44, based on RI slug tests is 1.4 feet/day, compared to 50 feet/day presented by Cardinell. Cardinell provided an estimated hydraulic conductivity value of 50 feet/day based on a general composition of fine sand, mixed with some silt and clay. The average hydraulic conductivity and transmissivity for the Castle Hayne at Site 44 is 17.8 feet/day and 3,560 feet²/day, respectively. Cardinell's report presents hydraulic conductivities and transmissivities from several studies. Hydraulic conductivities range from 14 to 91 feet/day and transmissivities range from 820 to 26,000 feet²/day. The RI results for Site 44 are comparable with other sites throughout Camp Lejeune.

The calculated groundwater flow velocities of the surficial aquifer varied within an order of magnitude across the site. The velocity values ranged from 0.01 at 44-GW05 to 0.05 at 44-GW04. The variations in groundwater flow velocities across the site are likely due to the heterogeneous soil conditions at the site. These heterogeneities cause the hydraulic properties to change spatially.

The calculated groundwater flow velocities for the Castle Hayne were 0.36 feet/day at 44-GW01DW and 0.35 feet/day at 44-GW06DW. The higher velocities of the Castle Hayne aquifer as compared to the surficial aquifer are attributable to higher hydraulic conductivity values of the Castle Hayne.

Groundwater flow in the surficial aquifer at Site 44 is toward Edwards Creek and the unnamed tributary, with an average velocity of 0.03 feet per day. Based on groundwater flow direction and groundwater elevation relative to surface water elevations, the surficial aquifer discharges to Edwards Creek and the unnamed tributary.

Groundwater flow in the upper Castle Hayne aquifer is east under the site with an average velocity of 0.36 feet/day. Groundwater elevation data compiled and mapped by Cardinell indicate that groundwater in the Castle Hayne aquifer flows toward and discharges to the New River and its major tributaries, including the air station vicinity.

The Castle Hayne confining unit appears to be semi-confining. The groundwater elevations in the deep and shallow wells respond similarly to precipitation and/or atmospheric changes. The confining unit is relatively thin, approximately 5 feet thick, with a measured vertical permeability of 0.04 feet/day. Based on groundwater elevations in shallow and deep well clusters, there appears to be a consistent upward groundwater flow from the Castle Hayne to the surficial aquifer.

REMEDIAL INVESTIGATION ACTIVITIES

The field investigation program at OU No.6, Site 44, was initiated to detect and characterize potential impacts to human health and the environment resulting from past waste management activities. This section discusses the site-specific RI field investigation activities that were conducted to fulfill the objective. The RI field investigation of OU No.6 commenced on February 20, 1995 and continued through May 10, 1995. The RI field program at Site 44 consisted of a site survey; a soil investigation, which included drilling and sampling; a groundwater investigation, which included monitoring well installation, sampling, and aquifer testing; a surface water and sediment investigation; a habitat evaluation; and a bioassay study. The following sections detail the various investigation activities carried out during the RI.

A total of 13 borings were advanced to assess suspected waste disposal at Site 44; three of those borings were utilized for the installation of monitoring wells. Four of the 13 boring locations were completed in an area immediately surrounding monitoring well 44-GW03, identified in the Final RI/FS Work Plan for OU No.6 (Baker, 1994b). The remaining nine soil borings were completed at the various locations throughout the site.

The analytical program initiated during the soil investigation at Site 44 focused on suspected contaminants of concern, as indicated by information regarding previous disposal practices and investigation results. Each of the 13 soil samples were analyzed for TAL metals and full TCL organics (i.e., volatiles, semivolatiles, pesticides, and PCBs). Samples were prepared and handled as described in the previous section.

Soil samples from selected exploratory test pits were submitted for laboratory analysis of the compounds reported as part of TCLP and RCRA hazardous waste characteristics. Laboratory confirmation analysis of excavated soil was requested when staining was evident or when organic contamination was indicated by field screening. The TCLP samples were employed to characterize the nature of the visually contaminated material. Samples were prepared and handled as described in the previous section.

Groundwater samples were collected from three existing shallow wells (44-GW01, 44-GW02, and 44-GW03), the three newly installed shallow wells (44-GW04, 44-GW05, and 44-GW06), one

temporary well (44-TW01), and the two newly installed deep wells (44-GW01DW and 44-GW04DW) at Site 44. The groundwater sampling round was conducted at Site 44 in April of 1995.

Groundwater samples from three existing shallow wells, three newly installed shallow wells, two newly installed deep wells, and one temporary well were submitted for laboratory analysis from Site 44. Samples were analyzed for full TCL organics (i.e., volatiles, semivolatiles, pesticides, and PCBs), TAL total metals, total suspended solids (TSS), and total dissolved solids (TDS). In addition, the groundwater sample obtained from 44-GW01 was also analyzed for TAL dissolved metals. Table 3-8 provides a summary of groundwater samples submitted for laboratory analysis during the groundwater investigation. The groundwater samples were analyzed using Contract Laboratory Program (CLP) protocols and Level IV data quality.

A total of 8 surface water and 16 sediment samples were collected at Site 44 during the initial sampling event in May of 1995. Each sampling station yielding one surface water and two sediment samples. Five of the sampling stations were located in Edwards Creek and three were located in an unnamed tributary to Edwards Creek.

An additional eight samples were later collected to more adequately assess the extent of surface water contamination in Edwards Creek. The eight samples from Edwards Creek were submitted in September of 1995 for laboratory analysis of volatile organic compounds only. Based upon the results of the initial surface water sampling event, four of the eight additional samples were collected from previously sampled locations (44-EC-SW01 through 44-EC-SW04). The remaining four additional sample locations were situated upgradient of the initial sampling stations.

The analytical program at Site 44 was intended to assess the nature and extent of contamination in surface waters and sediments that may have resulted from past disposal practices. As a result, the analytical program focused on suspected contaminants of concern, based upon knowledge of suspected wastes and the overall quality of surface water and sediment. Both surface water and sediment samples were analyzed for full TCL organics and TAL metals. Surface water samples were also analyzed for TAL dissolved metals and hardness. In addition to organic and inorganic analyses, sediment samples were also analyzed for TOC and grain size.

An additional eight surface water samples from Edwards Creek were analyzed for TCL volatiles only. The additional samples were requested as a result of analytical data gathered during the initial sampling event. Volatile organic compounds were observed in Edwards Creek surface water samples with increasing upgradient concentrations.

A two-pronged ecological investigation, consisting of a habitat evaluation and a bioassay study, was conducted at Site 44. During the habitat evaluation, dominant vegetation types and species were identified in the field; those plants that could not be readily identified were collected for further examination in the office. Amphibians, reptiles, birds, and mammals were also identified as visual sightings or evidence allowed. In many cases, the animals themselves were not seen, but scat, tracks, feeding areas, or remains were noted. From this information, ecological communities were established and biohabitat maps developed.

The bioassay study was conducted in a laboratory environment, using surface water and sediment samples that were retained from Site 44. A 7-day survival and growth study of fathead minnows

was performed with each of the surface water samples. In addition to the surface water test, a 10-day survival and growth bioassay study was conducted using the sediments retained from Site 44.

EXTENT OF CONTAMINATION

This section presents a summary of analytical findings from field sampling activities conducted at Site 44. Table ES-1 provides a summary of site contamination for Site 44

Soils

A total of four semivolatile contaminants, including two PAH compounds, were identified during the soil investigation at Site 44. The two PAH compounds were identified in both surface and subsurface soil samples. As provided in Table ES-1, each of the semivolatile compounds were detected at concentrations less than 550 µg/kg.

The pesticides 4,4'-DDE, 4,4'-DDD, and 4,4'-DDT appear to be the most widely distributed compounds in soil at Site 44. Each of the observed pesticides were detected in at least 5 of the 26 soil samples. The pesticide 4,4'-DDE was the most prevalent, with eight positive detections ranging from 3.2 to 370 µg/kg. The highest pesticide concentration was that of 4,4'-DDD at 2,500 µg/kg. In general, slightly higher concentrations of pesticides were observed in samples obtained from the central portion of the study area, particularly in samples 44-GW01DW and OA-SB05.

Inorganic analytes were detected in both surface and subsurface soil samples throughout the study area. Arsenic, chromium, and manganese were each detected above twice their average base-specific background levels in 11 of the 13 surface soil samples. Both copper and zinc were detected at concentrations in excess of ten times the average base-specific background level in a surface sample obtained from station OA-SB03. In general, however, inorganic analytes in subsurface soils were detected at concentrations within base-specific background levels.

Groundwater

Inorganics were the most prevalent and widely distributed constituents in groundwater at Site 44. Concentrations of TAL total metals were generally higher in shallow groundwater samples than in samples collected from the deeper aquifer. Iron and manganese were the most prevalent inorganic analytes, detected at concentrations that exceeded standards in each of the groundwater samples.

Positive detections of organic compounds were limited to the temporary monitoring well (44-TW01) and an existing shallow monitoring well (44-GW03). Of the eight organic compounds detected in 44-GW03, only tetrachloroethene and naphthalene concentrations exceeded state or federal screening standards. Only one of the three volatile compounds detected in sample 44-TW01, vinyl chloride, exceeded screening criteria.

TABLE ES-1

**SUMMARY OF SITE CONTAMINATION
SITE 44, JONES STREET DUMP
REMEDIAL INVESTIGATION, CTO-0303
MCB, CAMP LEJEUNE, NORTH CAROLINA**

Media	Fraction	Detected Contaminants	Comparison Criteria		Site Contamination				
			Standard	Base Background	Min.	Max.	Max. Location	Detection Frequency	Distribution
Surface Soil	Volatiles	ND	NA	NA				0/13	
	Semivolatiles	bis(2-Chloroethyl)ether	NA	NA	550	550	OA-SB06	1/13	eastern
		2,6-Dinitrotoluene	NA	NA	380	380	OA-SB02	1/13	open area
		I(1,2,3-cd)pyrene (PAH)	NA	NA	220	220	OA-SB05	1/13	east central
		B(g,h,i)perylene (PAH)	NA	NA	57	200	OA-SB05	2/13	east central
	Pesticides	4-4'-DDE	NA	NA	10	140	OA-SB05	4/13	scattered
		4-4'-DDD	NA	NA	7.4	7.4	OA-SB03	1/13	near marsh area
		4-4'-DDT	NA	NA	4.6	45	OA-SB03	4/13	scattered
	PCBs	ND	NA	NA				0/7	
	Metals (1)	Arsenic	NA	1.3	0.8	4.9	WA-SB02	13/13	11 exceed BB, evenly dispersed
		Chromium	NA	6.7	4.2	16.4	OA-SB01	12/13	11 exceed BB, evenly dispersed
		Copper	NA	7.2	0.9	910	OA-SB03	12/13	1 exceeds BB, near marsh area
		Lead	NA	23.7	5.9	31.7	OA-SB03	11/13	1 exceeds BB, near marsh area
		Manganese	NA	18.5	4.9	44.2	OA-SB03	13/13	11 exceed BB, evenly dispersed
		Zinc	NA	13.9	2.7	156	OA-SB03	13/13	2 exceed BB, max. near marsh
Subsurface Soil	Volatiles	ND	NA	NA				0/13	
	Semivolatiles	I(1,2,3-cd)pyrene (PAH)	NA	NA	55	130	OA-SB05	2/13	east central
		B(g,h,i)perylene (PAH)	NA	NA	40	120	OA-SB05	3/13	east central
	Pesticides	4,4'-DDE	NA	NA	3.2	370	44-GW01DW	4/13	scattered
		4,4'-DDD	NA	NA	5.6	2,500	44-GW01DW	4/13	scattered
		4,4'-DDT	NA	NA	150	150	44-GW01DW	1/13	central
	PCBs	ND	NA	NA				0/7	

TABLE ES-1 (Continued)

SUMMARY OF SITE CONTAMINATION
 SITE 44, JONES STREET DUMP
 REMEDIAL INVESTIGATION, CTO-0303
 MCB, CAMP LEJEUNE, NORTH CAROLINA

Media	Fraction	Detected Contaminants	Comparison Criteria		Site Contamination				
			Standard	Base Background	Min.	Max.	Max. Location	Detection Frequency	Distribution
Subsurface Soil (Continued)	Metals (1)	Arsenic	NA	1.9	0.3	2.5	WA-SB04	10/13	1 exceeds BB, west central
		Copper	NA	2.4	0.4	3	44-GW01DW	9/13	1 exceeds BB, central
		Lead	NA	8.3	1.4	9	44-GW01DW	11/13	2 exceed BB, central
		Manganese	NA	7.9	1.3	9.3	WA-SB02	13/13	2 exceed BB
		Nickel	NA	3.7	1.3	15.8	44-GW01DW	6/13	2 exceed BB
		Zinc	NA	6.7	0.8	10.8	WA-SB04	12/13	1 exceeds BB, west central
Groundwater	Volatiles	Vinyl Chloride	NCWQS - 0.015	NA	10	10	44-TW01	1/9	1 exceeds standard, marsh area
		1,2-Dichloroethene (total)	MCL - 70	NA	15	15	44-TW01	1/9	does not exceed standard, marsh
		Trichloroethene	MCL - 5	NA	1	1	44-TW01	1/9	does not exceed standard, marsh
		Tetrachloroethene	NCWQS - 0.7	NA	1	1	44-GW03	1/9	1 exceeds standard, southwestern
	Semivolatiles	Naphthalene (PAH)	NCWQS - 21	NA	71	71	44-GW03	1/9	1 exceeds standard, southwestern
		2-Methylnaphthalene	NA	NA	4	4	44-GW03	1/9	southwestern, near access road
		Acenaphthene (PAH)	NCWQS - 800	NA	13	13	44-GW03	1/9	does not exceed standard
		Dibenzofuran	NA	NA	6	6	44-GW03	1/9	southwestern, near access road
		Fluorene (PAH)	NCWQS - 280	NA	7	7	44-GW03	1/9	does not exceed standard
		Phenanthrene (PAH)	NCWQS - 210	NA	7	7	44-GW03	1/9	does not exceed standard
		Carbazole	NA	NA	4	4	44-GW03	1/9	southwestern, near access road
		Pesticides	ND	NCWQS/MCL	NA				0/9
	PCBs	ND	NCWQS/MCL	NA				0/9	
	Total Metals	Iron	NCWQS - 300	NA	285	72,900	44-GW04	9/9	8 exceed standard, scattered
Manganese		NCWQS - 50	NA	21.6	241	44-GW04	8/9	5 exceed standard, scattered	

ES-7

TABLE ES-1 (Continued)

SUMMARY OF SITE CONTAMINATION
 SITE 44, JONES STREET DUMP
 REMEDIAL INVESTIGATION, CTO-0303
 MCB, CAMP LEJEUNE, NORTH CAROLINA

Media	Fraction	Detected Contaminants	Comparison Criteria		Site Contamination				
			Standard	Base Background	Min.	Max.	Max. Location	Detection Frequency	Distribution
Surface Water (2)	Volatiles	Vinyl Chloride	NCWQS - 525	NA	7	38	EC-SW08	8/16	max. upgradient, decreases by site
		1,1-Dichloroethene	NCWQS - 3.2	NA	1	2	EC-SW06	3/16	each detection upgradient
		1,2-Dichloroethene (total)	NCWQS - 7.0	NA	2	150	EC-SW01	14/16	12 exceed standard, max. upgradient
		Trichloroethene	NCWQS - 92.4	NA	2	66	EC-SW01	14/16	max. upgradient, decreases by site
		1,1,2-Trichloroethane	NCWQS - 42	NA	1	1	EC-SW08	1/16	upgradient
		1,1,2,2-Tetrachloroethane	NCWQS - 10.8	NA	5	42	EC-SW08	12/16	9 exceed standard, max. upgradient
	Semivolatiles	Phenol	NCWQS - 300	NA	1	1	UT-SW01	1/8	low detection, UT
	Pesticides	ND	NCWQS/NOAA	NA				0/8	
	PCBs	ND	NCWQS/NOAA	NA				0/8	
	Metals (3)	Lead	NCWQS - 25	10.4	0.8	11.2	EC-SW02	2/8	1 exceeds BB not standard
Sediment	Volatiles	Acetone	NA	NA	15	610	UT-SD01	11/16	1 exceeds blank cont. level (240)
	Semivolatiles	Pentachlorophenol	NA	NA	340	740	EC-SD01	2/16	up and downgradient, EC
		Phenanthrene (PAH)	NOAA - 225	NA	49	250	UT-SD03	5/16	primarily UT
		Carbazole	NA	NA	79	79	UT-SD03	1/16	near confluence with EC, UT
		Fluoranthene (PAH)	NOAA - 600	NA	95	740	UT-SD03	6/16	1 exceeds standard, UT
		Pyrene (PAH)	NOAA - 350	NA	42	490	UT-SD03	7/16	1 exceeds standard, UT
		Butylbenzylphthalate	NA	NA	48	48	UT-SD02	1/16	by concrete outflow/culvert, UT
		B(a)anthracene (PAH)	NOAA - 230	NA	50	170	UT-SD03	3/16	do not exceed standard, UT
		Chrysene (PAH)	NOAA - 400	NA	44	460	UT-SD03	7/16	1 exceeds standard, UT
		B(b)fluoranthene (PAH)	NA	NA	52	600	UT-SD03	6/16	UT and downgradient of UT
		B(k)fluoranthene (PAH)	NA	NA	49	200	UT-SD03	3/16	all detections from UT
		Benzo(a)pyrene (PAH)	NOAA - 400	NA	56	300	UT-SD03	3/16	do not exceed standard, UT
		B(g,h,i)perylene (PAH)	NA	NA	49	71	UT-SD02	2/16	1 detection EC and 1 UT

ES-8

TABLE ES-1 (Continued)

SUMMARY OF SITE CONTAMINATION
 SITE 44, JONES STREET DUMP
 REMEDIAL INVESTIGATION, CTO-0303
 MCB, CAMP LEJEUNE, NORTH CAROLINA

Media	Fraction	Detected Contaminants	Comparison Criteria		Site Contamination				
			Standard	Base Background	Min.	Max.	Max. Location	Detection Frequency	Distribution
Sediment (Continued)	Pesticides	Aldrin	NA	NA	2.6	2.6	UT-SD03	1/14	UT
		Heptachlor Epoxide	NA	NA	5.2	5.2	UT-SD03	1/14	UT
		4,4'-DDE	NOAA - 2	NA	9.3	310	UT-SD02	16/16	16 exceed standard
		4,4'-DDD	NOAA - 2	NA	5.5	770	UT-SD02	16/16	16 exceed standard
		4,4'-DDT	NOAA - 1	NA	2.5	130	EC-SD05	10/14	10 exceed standard, prevalent
		alpha-Chlordane	NOAA - 0.5	NA	2	14	EC-SD05	13/16	13 exceed standard, prevalent
		gamma-Chlordane	NOAA - 0.5	NA	2.7	16	EC-SD05	13/16	13 exceed standard, prevalent
	PCBs	ND	NOAA	NA				0/13	
	Metals (3)	Lead	NOAA - 35	314	8.4	56.3	UT-SD03	16/16	3 exceed standard, not BB
		Zinc	NOAA - 120	926	6.3	144	EC-SD05	16/16	1 exceeds standard, not BB

Notes:

- Concentrations are presented in µg/L for liquid and µg/Kg for solids (ppb), metal concentrations for soils and sediments are presented in mg/Kg (ppm).

(1) Metals in both surface and subsurface soils were compared to twice the average base background positive concentrations for priority pollutant metals only (i.e., antimony, arsenic, beryllium, cadmium, chromium, copper, lead, mercury, nickel, selenium, silver, thallium, zinc).

(2) Surface water detections were compared to appropriate NCWQS and NOAA screening values, based upon the observed percentage of saltwater at each sampling location.

(3) Total metals in surface water and sediment were compared to the maximum positive detections in upgradient samples at MCB, Camp Lejeune.

BB - Base background, value equals two times average value for soil and the maximum value for surface water and sediment (refer to Appendix P)

BEHP - bis(2-ethylhexyl)phthalate

EC - Edwards Creek

NA - Not applicable

NCWQS - North Carolina Water Quality Standard

ND - Not detected

NOAA - National Oceanic and Atmospheric Administration

MCL - Federal Maximum Contaminant Level

PAH - Polynuclear aromatic hydrocarbon

UT - Unnamed Tributary

ES-9

Surface Water

Edwards Creek

A total of 6 VOCs were detected among the 13 surface water samples obtained from Edwards Creek. Both 1,2-dichloroethene (total) and trichloroethene were detected in each of the 13 samples obtained from Edwards Creek. The maximum concentrations of 1,2-dichloroethene (total) and trichloroethene were 150 and 66 µg/L. Vinyl chloride and 1,1,2,2-tetrachloroethane were next most prevalent VOCs detected among Edwards Creek surface water samples. Vinyl chloride was detected in eight surface water samples with a maximum concentration of 38 µg/L. As provided in Table 4-2, 1,1,2,2-tetrachloroethane was detected in 12 of the samples obtained from Edwards Creek with a maximum concentration of 42 µg/L. Nine of the 1,1,2,2-tetrachloroethane detections exceeded the NCWQS screening value of 10.8 µg/L. Twelve of the 1,2-dichloroethene (total) detections exceeded the 7.0 µg/L screening value. None of the other positive VOC detections exceeded applicable screening values. Lastly, the VOCs 1,1-dichloroethene and 1,1,2-trichloroethane were also detected among the surface water samples at maximum concentrations of 2 and 1 µg/L, respectively.

Thirteen of 23 TAL total metals were positively identified among the five surface water samples obtained from Edwards Creek (antimony, arsenic, beryllium, cadmium, chromium, cobalt, mercury, selenium, silver, and thallium were not detected). Positive detections of metals were compared to screening standards for surface water bodies classified as fresh water (i.e., containing less than five percent saltwater). Lead was detected in only one of the five surface water samples obtained from Edwards Creek in excess of the 10.4 µg/L maximum base background concentration. No other total metal concentrations in the four surface water samples exceeded state or federal screening values.

Unnamed Tributary

Positive detections of two volatile organic compounds were observed among the three surface water samples obtained from the unnamed tributary to Edwards Creek. The VOCs 1,2-dichloroethene and trichloroethene were detected at a concentrations of 5 and 2 µg/L in sample UT-SW03, located approximately 150 feet upstream of the Edwards Creek confluence. Phenol was the only SVOC detected among surface water samples submitted for laboratory analysis from Site 44. At sampling location UT-SW01 phenol was detected at a concentration of 1 µg/L. None of the volatile or semivolatile detections exceeded applicable state or federal screening values.

Laboratory analyses of four surface water samples retained from the unnamed tributary indicate that 12 of 23 possible total metals were positively detected. None of the total metal concentrations in the three surface water samples obtained from the unnamed tributary to Edwards Creek exceeded state or federal screening values.

Sediment

Edwards Creek

Unlike surface water, volatile organic compounds were not detected in any of the ten sediment samples obtained from Edwards Creek. A total of seven SVOCs were detected, however, among seven of the ten sediment samples; six of the seven SVOCs detected were PAHs. A majority of the SVOC detections in Edwards Creek sediment samples were from station EC-SD05, located downstream of the unnamed tributary confluence. Pentachlorophenol was positively detected in two

of the sediment samples at a maximum concentration of 740 µg/kg in upstream location EC-SD01. The maximum PAH concentration was that of fluoranthene at 120 µg/kg. Phenanthrene, pyrene, chrysene, benzo(b)fluoranthene, and benzo(g,h,i)perylene were also detected in at least one of the ten Edwards Creek samples. None of the positive SVOC detections in samples obtained from Edwards Creek exceeded applicable NOAA screening values.

The pesticides 4,4'-DDE and 4,4'-DDD were detected in each of the ten sediment samples obtained from Edwards Creek. Both of these pesticides were detected at their respective maximum concentrations within a sample obtained from station EC-SD05, located downstream of the unnamed tributary confluence. As indicated in Table ES-1, each of the 4,4'-DDE and 4,4'-DDD detections were in excess of NOAA Effects Range-Low (ER-L) screening values. Alpha-chlordane and gamma-chlordane were detected in nine of the ten sediment samples at concentrations in excess of screening values. Both alpha-chlordane and gamma-chlordane were detected at maximum concentrations of 14 and 16 µg/kg in sample EC-SD05. The pesticide 4,4'-DDT was detected in eight of the ten Edwards Creek sediment samples, at concentrations exceeding screening values. The maximum 4,4'-DDT detection, 130 µg/kg, was also observed in one of the samples obtained from station EC-SD05. Each of the pesticide detections in sediment samples represented an exceedance of appropriate NOAA screening criteria.

Twenty of 23 TAL total metals were positively identified among the ten Edwards Creek sediment samples (antimony, mercury, and thallium were not detected). Lead and zinc were detected at concentrations in excess of their respective NOAA screening values of 35 and 120 mg/kg. As provided in Table ES-1, one detection of lead at 43.5 mg/kg and one detection of zinc at 144 mg/kg exceeded applicable sediment screening values in a sample obtained from station EC-SD05. Neither the lead nor the zinc detection in EC-SD05 exceeded base-specific background concentrations.

Unnamed Tributary

Acetone was the only volatile organic compound detected among the six unnamed tributary sediment samples. No other VOC was detected among sediment samples from both Edwards Creek and the unnamed tributary to Edwards Creek. Acetone was identified at a concentration of 610 µg/kg in a sample obtained from station UT-SD01, which exceeded ten times the maximum QA/QC blank concentration.

A total of 11 semivolatile compounds were identified in sediment samples obtained from the unnamed tributary to Edwards Creek. As provided in Table ES-1, 9 of the 11 SVOCs detected were PAH compounds. No semivolatile compounds were detected at location UT-SD01, located upstream of two 36-inch drainage culverts which discharge to the unnamed tributary. The majority of maximum SVOC detections were observed in samples obtained from location UT-SD03. The maximum semivolatile concentration among sediment samples obtained from the unnamed tributary was that of fluoranthene. As presented in Table ES-1, four semivolatiles were each detected once among unnamed tributary samples at concentrations exceeding applicable NOAA screening values. Fluoranthene, pyrene, and chrysene were detected at their maximum concentrations of 740, 490, and 460 µg/kg in a sample obtained from UT-SD03, approximately 150 feet from the confluence with Edwards Creek. Benzo(g,h,i)perylene was detected at a maximum concentration of 71 µg/kg in sample UT-SD02, adjacent to the culvert outfall.

The pesticides 4,4'-DDD, and 4,4'-DDE were detected in each of the six unnamed tributary sediment samples. As indicated in Table 4-2, 4,4'-DDD and 4,4'-DDE were detected at maximum

concentrations of 310 and 770 µg/kg in a sample obtained from station UT-SD02. The pesticide 4,4'-DDT was detected in three of the six samples at a maximum concentration of 3.7 µg/kg. Alpha-chlordane and gamma-chlordane were detected in four of the six samples at maximum concentrations of 7.8 and 9.5 µg/kg. Each of the pesticide detections in sediment samples represented an exceedance of appropriate NOAA screening criteria. The upstream sampling station, UT-SD01, had the fewest detections of pesticide compounds.

Sixteen of 23 TAL total metals were positively identified in the seven sediment samples from the unnamed tributary (antimony, beryllium, cadmium, cobalt, mercury, silver, and thallium were not detected). Of the 16 metals detected, only lead was identified at concentrations in excess of NOAA ER-L screening value of 35 mg/kg. Lead was detected twice among the six sediment samples obtained from the unnamed tributary at concentrations in excess of the screening value. Lead was detected at 53 and 56 mg/kg in the two samples obtained from station UT-SD03. All other TAL metals detected in sediment samples from the unnamed tributary were within base-specific background concentrations.

HUMAN HEALTH RISK ASSESSMENT

At Site 44, exposure to surface soil, surface water and sediment was assessed for the current receptors. Surface soil, groundwater, surface water, and sediment exposure were evaluated for the future residents. Subsurface soil exposure was evaluated for the future construction worker.

In the current case, the following receptors were assessed: military personnel and adult and child trespassers. Receptor exposure to surface soil, surface water, sediment was examined. The risks calculated for all exposure pathways and receptors were within acceptable risk ranges.

In the future case, child and adult residents were assessed for potential exposure to groundwater, surface soil, surface water, and sediment. A construction worker was evaluated for subsurface soil exposure. The potential noncarcinogenic and carcinogenic risks for the construction worker at Site 44 were within acceptable levels. The carcinogenic risk for the future child resident was 1.0×10^{-4} . The carcinogenic risk for the future adult resident was 2.0×10^{-4} . Both ICR values are driven by the presence of vinyl chloride in groundwater.

It should be noted that vinyl chloride was detected in only one groundwater sample from well location 44-TW01-01. This well is located approximately 50 feet from the Edwards Creek. Due to the location of the well, the presence of vinyl chloride appears to be related to creek contaminants rather than migration of groundwater contaminants. In addition, VOCs were not detected in surface soil, subsurface soil, and other groundwater samples at Site 44.

The noncarcinogenic risk from groundwater ingestion for the future child resident was 16. The noncarcinogenic risk from groundwater ingestion for the future adult resident was 7.1. This value exceeds the acceptable risk value of one. The iron in groundwater is driving this risk.

The iron constitutes 98% of both elevated risk values. Without iron as a COPC, the noncarcinogenic risk values for future residential adults and children would be 0.15 and 0.35, respectively. The studies that prompted the addition of a RBC value for iron are provisional only and have not undergone formal review by the USEPA. Also, iron is considered an essential nutrient.

Finally, it should be noted that groundwater in the MCB Camp Lejeune area is naturally rich in iron. In addition, there is no record of any historical use of iron at Site 44. Consequently, it is assumed that iron is a naturally occurring inorganic analyte in groundwater, and its presence is not attributable to site operations.

ECOLOGICAL RISK ASSESSMENT

Aquatic Receptors

As presented earlier in the ERA, the assessment endpoints for the aquatic receptors are potential decreases in the survival, growth, and/or reproduction of the aquatic receptor population or subpopulation that is attributable to site-related contaminants. These assessment endpoints are evaluated using a series of measurement endpoints. This section of the ERA examines each of the measurement endpoints to determine if the assessment endpoints are impacted.

The first measurement endpoint is decreased survival and growth of P. promelas and C. tentans, decreased survival and reproduction of C. dubia, and decreased survival of H. azteca as compared to controls. The bioassay samples were collected at station 44-EC-SW/SD02 in an area of relatively high pesticide detections (several orders of magnitude greater than the SSSVs). Manganese and nickel concentrations slightly exceeded the SWSVs at this station. For the surface water bioassay, adverse survival effects were observed in the C. dubia bioassay, however, no adverse survival or growth effects were observed in the P. promelas bioassay. Therefore, the metals in the surface water may be causing a decrease in survival of C. dubia. No decrease in survival or growth of H. azteca or C. tentans was observed in the Site 44 sediment sample.

The second measurement endpoint is determining if the contaminant concentrations in the surface water and sediment exceed the contaminant-specific surface water and sediment effect concentrations (i.e., SWSVs, and SSVs). Several metals, SVOCs, and pesticides were detected in the surface water and/or sediment at concentrations above the SWSVs or SSVs. Based on the screening value comparison, there is a moderate to high potential for a decrease in the population of aquatic receptors from pesticides in the sediments. There is only a low potential for a decrease in the population of aquatic receptors from metals in the surface water and sediment, and SVOCs in the sediment, since the concentration of these contaminants only slightly exceeded the screening values or were detected infrequently.

It should be noted that the highest pesticide concentrations were detected at Stations 44-UT-SD02, 44-EC-SD02 and 44-EC-SD05 while elevated lead and SVOC concentrations were detected at Station 44-UT-SD03. The source of the pesticides is not known since pesticides reportedly were not stored or disposed at Site 44. In addition, since the high pesticide concentrations were detected in non-adjacent locations, the pesticides may be due to the periodic pesticide spraying that occurred on the base. Lead was detected at low concentrations in the groundwater (maximum detection of 1.4 ug/L) and surface soil (maximum detection of 31.7 mg/kg). Therefore, the lead in the surface water (maximum detection 11.2 ug/L) and sediment (maximum detection 56.3 mg/kg) does not appear to be site-related. Phenanthrene was the only SVOC in the sediment that was detected in the groundwater (7 ug/L), and none of the SVOCs in the sediment were detected in the surface soil. Therefore, it does not appear that the SVOCs in the sediment are site-related, but may be related to a lift station that discharges into the unnamed tributary.

Several VOCs were detected in the surface water. Based on the comparison to screening values there does not appear to be a risk to aquatic species. It should be noted, however, that the source of the VOCs originates upstream of Site 44, based on the additional sampling event.

Terrestrial Receptors

As presented earlier in the ERA, the assessment endpoints for the terrestrial receptors is the potential reduction of a receptor population or subpopulation that is attributable to contaminants from the site. This section evaluates this assessment endpoint using the measurement endpoints.

The first measurement endpoint is determining if there is an exceedance of contaminant-specific soil effect concentrations (i.e., SSSVs). Several SVOCs, pesticides, and metals were detected in the surface soil at concentrations that exceed the SSSVs. Much of the study area at Site 44 is heavily vegetated with dense understory and trees greater than three inches in diameter. Therefore, ecological receptors have a high potential for becoming exposed to contaminants in the surface soil.

The second measurement endpoint is determining if the terrestrial CDI exceeds the TRVs. The cottontail rabbit and the raccoon are the only terrestrial species with estimated CDI values that exceeded the TRV values. However, the COPCs causing the majority of the risk (aluminum, iron, and/or vanadium) are not related to past site activities, and are common naturally occurring metals. Therefore, they are not considered to be site-related.

Overall, some potential impacts to soil invertebrates and plants may occur as a result of site-related contaminants. It should be noted that there is much uncertainty in the SSSVs. A potential decrease in the terrestrial vertebrate population from site-related contaminants is not expected based on the terrestrial intake model.

1.0 INTRODUCTION

Marine Corps Base (MCB), Camp Lejeune was placed on the Comprehensive Environmental Response, Compensation, and Liability Act (CERCLA) National Priorities List (NPL) on October 4, 1989 (54 Federal Register 41015, October 4, 1989). Subsequent to this listing, the United States Environmental Protection Agency (USEPA) Region IV; the North Carolina Department of Environment, Health and Natural Resources (NC DEHNR); and the United States Department of the Navy (DoN) entered into a Federal Facilities Agreement (FFA) for MCB, Camp Lejeune. The FFA ensures that environmental impacts associated with past and present activities at MCB, Camp Lejeune are thoroughly investigated and appropriate CERCLA response/Resource Conservation and Recovery Act (RCRA) corrective action alternatives are developed and implemented, as necessary, to protect public health, welfare, and the environment (FFA, 1989).

The Fiscal Year 1996 Site Management Plan for MCB, Camp Lejeune, the primary document referenced in the FFA, identifies 33 sites that require Remedial Investigation/Feasibility Study (RI/FS) activities. These 33 sites have been divided into 16 operable units to simplify RI/FS activities. An RI was conducted at Operable Unit (OU) No. 6, Sites 36, 43, 44, 54, and 86, during February through May of 1995. This report describes the RI conducted at Site 44, the Jones Street Dump. Four additional reports have been prepared that address each of the other OU No. 6 sites. Figure 1-1 depicts the location of the five sites that comprise OU No. 6. [Note that all tables and figures are presented in the back of each section.]

The purpose of an RI is to evaluate the nature and extent of the threat to public health and the environment caused by the release or threatened release of hazardous substances, pollutants, or contaminants. This RI investigation was conducted through the sampling of several environmental media (soil, groundwater, surface water, sediment, and fish tissue) at OU No. 6, evaluating the resultant analytical data, and performing a human health risk assessment (RA) and ecological RA. This RI report contains the results of all field investigations, the human health RA, and the ecological RA. Furthermore, the RI report provides information to support the FS and Record of Decision (ROD) documents.

This RI Report has been prepared by Baker Environmental, Inc. (Baker) and submitted to the USEPA Region IV; the NC DEHNR; MCB, Camp Lejeune Environmental Management Department (EMD); the Navy Environmental Health Center (NEHC); the Agency for Toxic Substances and Disease Registry; and to the Naval Facilities Engineering Command, Atlantic Division (LANTDIV) for their review.

The following subsections describe the arrangement of OU No. 6 and the background and setting of both MCB, Camp Lejeune and Site 44. In addition, Section 1.1 provides an overview of the RI report's organization.

1.1 Report Organization

This RI Report is comprised of one text volume; appendices are provided in an additional volume. The following section headings are included within this text volume and provide site-specific investigation findings:

- Study Area Investigation - Section 2.0
- Site Physical Characteristics - Section 3.0
- Nature and Extent of Contamination - Section 4.0
- Contaminant Fate and Transport - Section 5.0
- Baseline Human Health Risk Assessment - Section 6.0
- Ecological Risk Assessment - Section 7.0
- Conclusions - Section 8.0

1.2 Background and Setting of MCB, Camp Lejeune

The following section summarizes existing background and setting information that pertains to MCB, Camp Lejeune. This section specifically addresses the location and setting of MCB, Camp Lejeune, its history, topography, geology, hydrogeology, climatology, ecology, land use, and demography.

1.2.1 Location and Setting

MCB, Camp Lejeune is located on the coastal plain of North Carolina in Onslow County. The facility encompasses approximately 234 square miles and is bisected by the New River. The New River flows in a southeasterly direction and forms a large estuary before entering the Atlantic Ocean. The southeastern border of MCB, Camp Lejeune is the Atlantic Ocean shoreline. The western and northeastern boundaries of the facility are U.S. Route 17 and State Route 24, respectively. The City of Jacksonville borders MCB, Camp Lejeune to the north (refer to Figure 1-1).

1.2.2 History

Construction of MCB, Camp Lejeune began in April 1941 at the Hadnot Point Industrial Area (HPIA), where major functions of the base are located today. The facility was designed to be the "World's Most Complete Amphibious Training Base." The MCB, Camp Lejeune complex consists of five geographical locations under the jurisdiction of the Base Command. These areas include Camp Geiger, Montford Point, Courthouse Bay, Mainside, and the Rifle Range Area. Site 36 is located within the Camp Geiger operations area. The remaining four sites that comprise OU No. 6, Sites 43, 44, 54, and 86, are located within the Marine Corps Air Station (MCAS), New River operations area. Although MCAS, New River is under the jurisdiction of a separate command (i.e., MCAS, Cherry Point), environmental compliance issues and Installation Restoration Program (IRP) sites are the responsibility of MCB, Camp Lejeune EMD.

1.2.3 Operable Unit Description

Operable units are formed as an incremental step toward addressing individual site concerns. There are currently 33 Installation Restoration Program (IRP) sites at MCB, Camp Lejeune, which have been grouped into 16 operable units. Due to the similar nature of suspected waste and their close proximity to one another, Sites 36, 43, 44, 54, and 86 were grouped together as OU No. 6. Figure 1-2 depicts the locations of all 16 operable units at MCB, Camp Lejeune.

OU No. 6 is located within the northwest portion of the facility, to the south and east of Camp Geiger Development Area. Site 36 is referred to as the "Camp Geiger Area Dump," Site 43 is the "Agan Street Dump," Site 44 is known as the "Jones Street Dump," Site 54 is the "Crash Crew Fire Training Burn Pit," and Site 86 is known as the "Above Ground Storage Tank Area."

1.2.4 Topography

The flat topography of MCB, Camp Lejeune is typical of seaward portions of the North Carolina coastal plain. Elevations on the base vary from sea level to 72 feet above mean sea level (msl); however, most of MCB, Camp Lejeune is between 20 and 40 feet above msl.

Drainage at MCB, Camp Lejeune is generally toward the New River, except in areas near the coast where flow is into the Intracoastal Waterway that lies between the mainland and barrier islands. In developed areas of the facility, natural drainage has been altered by asphalt cover, storm sewers, and drainage ditches. Approximately 70 percent of MCB, Camp Lejeune is comprised of broad, flat interstream areas with poor drainage (WAR, 1983).

1.2.5 Surface Water Hydrology

The dominant surface water feature at MCB, Camp Lejeune is the New River. It receives drainage from a majority of the base. The New River is short with a course of approximately 50 miles on the central Coastal Plain of North Carolina. Over most of its length, the New River is confined to a relatively narrow channel in Eocene and Oligocene limestones. South of Jacksonville, the river widens dramatically as it flows across less resistant sands, clays, and marls. At MCB, Camp Lejeune, the New River flows in a southerly direction into the Atlantic Ocean through the New River Inlet. Several small coastal creeks drain the area of MCB, Camp Lejeune not associated with the New River and its tributaries. These creeks flow into the Intracoastal Waterway, which is connected to the Atlantic Ocean by Bear Inlet, Brown's Inlet, and the New River Inlet. The New River, the Intracoastal Waterway, and the Atlantic Ocean converge at the New River Inlet.

Water quality criteria for surface waters in North Carolina have been published under Title 15 of the North Carolina Administrative Code. At MCB, Camp Lejeune, the New River falls into two classifications: SC (estuarine waters not suited for body-contact sports or commercial shellfishing); and SA (estuarine waters suited for commercial shellfishing). The SC classification applies to only three areas of the New River at MCB, Camp Lejeune; the rest of the New River at MCB, Camp Lejeune falls into the SA classification (ESE, 1990).

1.2.6 Geology

MCB, Camp Lejeune is located within the Atlantic Coastal Plain physiographic province. The sediments of this province consist primarily of sand, silt, and clay. Other sediments may be present, including shell beds and gravel. Sediments may be of marine or continental origin. These sediments are found in interfingering beds and lenses that gently dip and thicken to the southeast. Sediments of this type range in age from early Cretaceous to Quaternary time and overlie igneous and metamorphic rocks of pre-Cretaceous age. Table 1-1 presents a generalized stratigraphic column for the Atlantic Coastal Plain of North Carolina (Harned et al, 1989).

United States Geological Survey (USGS) studies at MCB, Camp Lejeune indicate that the base is underlain by sand, silt, clay, calcareous clay and partially cemented limestone. The combined thickness of these sediments beneath the base is approximately 1,500 feet.

1.2.7 Hydrogeology

The aquifers of primary interest are the surficial aquifer and the aquifer immediately below it, the Castle Hayne aquifer. Other aquifers that occur beneath the facility include the Beaufort, Peedee, Black Creek, and upper and lower Cape Fear aquifers. The following summary is a compilation of information which pertains to aquifer characteristics within the MCB, Camp Lejeune area. A generalized hydrogeologic cross-section illustrating the relationship between the aquifers in this area is presented in Figures 1-3 and 1-4.

The surficial aquifer consists of interfingering beds of sand, clay, sandy clay, and silt that contain some peat and shells. The thickness of the surficial aquifer ranges from 0 to 73 feet and averages nearly 25 feet over the MCB, Camp Lejeune area. It is generally thickest in the interstream divide areas and presumed absent where it is cut by the New River and its tributaries. The beds are thin and discontinuous, and have limited lateral continuity. This aquifer is not used for water supply at MCB, Camp Lejeune.

The general lithology of the surficial aquifer and the absence of any thick, continuous clay beds are indications of relatively high vertical conductivity within the aquifer. The estimated lateral hydraulic conductivity of the surficial aquifer in the MCB, Camp Lejeune area is 50 feet per day, and is based on a general composition of fine sand mixed with some silt and clay (Harned et al., 1989). However, data from a number of slug tests conducted by Baker at sites near OU No. 6 indicate much lower lateral hydraulic conductivity values. These values range from 7.2×10^{-4} feet per day to 6.4 feet per day. Table 1-2 presents a summary of hydraulic properties compiled during investigations at other sites located within the developed portion of MCAS, New River.

Between the surficial and the Castle Hayne aquifers lies the Castle Hayne confining unit. This unit consists of clay, silt, and sandy clay beds. In general, the Castle Hayne confining unit may be characterized as a group of less permeable beds at the top of the Castle Hayne aquifer that have been partly eroded or incised in places. The Castle Hayne confining unit is discontinuous, and has a thickness ranging from 0 to 26 feet, averaging about 9 feet where present. There is no discernable trend in the thickness of the confining unit seen in these or related investigations, nor is there any information in the USGS literature regarding any trend of the depth of the confining unit.

Previously recorded data indicate that vertical hydraulic conductivity of the confining unit ranged from 0.0014 to 0.41 feet per day (Cardinell et al., 1993). Data obtained from a pump test conducted by ESE indicated a vertical hydraulic conductivity for this unit ranging from 1.4×10^{-3} to 5.1×10^{-2} feet per day (ESE, 1988). Based on the moderate conductivity values and the thin, discontinuous nature of the confining unit, this unit may only be partly effective in retarding the downward vertical movement of groundwater from the surficial aquifer.

The Castle Hayne aquifer lies below the surficial aquifer and consists primarily of unconsolidated sand, shell fragments, and fossiliferous limestone. Clay, silt, silty and sandy clay, and indurated limestone also occur within the aquifer. The upper part of the aquifer consists primarily of calcareous sand with some continuous and discontinuous thin clay and silt beds. The calcareous sand becomes more limy with depth. The lower part of the aquifer consists of consolidated or poorly consolidated limestone and sandy limestone interbedded with clay and sand.

The Castle Hayne aquifer is about 150 to 350 feet thick, increasing in thickness toward the ocean. The top of the aquifer lies approximately 20 to 73 feet below the ground surface. The top of the

aquifer dips southward and is deepest near the Atlantic coast, east of the New River. The top of the aquifer also forms a basin in the vicinity of Paradise Point. Estimates of hydraulic conductivity indicate a wide variation in range, from 14 to 91 feet per day. Table 1-3 presents estimates of the Castle Hayne aquifer and confining unit hydraulic properties in the vicinity of MCB, Camp Lejeune.

Onslow County and MCB, Camp Lejeune lie in an area where the Castle Hayne aquifer generally contains freshwater; however, the proximity of saltwater in deeper layers just below the aquifer and in the New River estuary is of concern in managing water withdrawals. Over-pumping of the deeper parts of the aquifer could cause encroachment of saltwater. The aquifer generally contains water having less than 250 milligrams per liter (mg/L) chloride throughout the base, except for one USGS well in the southern portion of the base that is screened in the lower portion of the aquifer. Chloride was measured at 960 mg/L in a sample collected in 1989 from this well.

Rainfall in the MCB, Camp Lejeune area enters the ground in recharge areas, infiltrates the soil, and moves downward until it reaches the surficial aquifer. Recharge areas at Camp Lejeune are mainly comprised of interstream areas. In the surficial aquifer, groundwater flows in the direction of lower hydraulic head until it reaches discharge points or fronts. These discharge areas include the New River and its tributaries and the ocean. Though most of the rainfall entering the surficial aquifer discharges to local streams, a relatively small amount infiltrates to the Castle Hayne. The surficial aquifer supplies the primary recharge to the Castle Hayne aquifer. Like the surficial aquifer, the Castle Hayne naturally discharges to the New River and major tributaries; however, pumping of the Castle Hayne may locally influence flow directions.

The potentiometric surface of the surficial aquifer varies seasonally, as seen through the observation of water levels in monitoring wells. The surficial aquifer receives more recharge in the winter than in the summer when much of the water evaporates or is transpired by plants before it can reach the water table. As a result, the potentiometric surface is generally highest in the winter months and lowest in the summer or early fall.

Water levels from wells placed in deeper aquifers, such as the Castle Hayne, were also used to establish potentiometric surfaces. Because the Castle Hayne is at least partially confined from the surficial aquifer and is not influenced by rainfall as strongly as the surficial aquifer, the seasonal variations tend to be slower and smaller than in surficial aquifer.

1.2.8 Ecology

The ecology at MCB Camp Lejeune is discussed in three sections that include ecological communities, sensitive environments and threatened and endangered species.

1.2.8.1 Ecological Communities

MCB, Camp Lejeune is located on North Carolina's coastal plain. A number of natural ecological communities are present within this region. In addition, variations of natural communities have occurred in response to disturbance and intervention (e.g., forest clearing, urbanization). The natural communities found in the area are summarized as follows:

- Mixed Hardwood Forest - Found generally on slopes of ravines. Beech, white oak, tulip, sweetgum, and holly are indicator species.

- Southeastern Evergreen Forest - Dominated by pines, especially longleaf pine.
- Loblolly Pine/Hardwoods Community - Second growth forest that includes loblolly pine with a mix of hardwoods (i.e., oak, hickory, sweetgum, sour gum, red maple, and holly).
- Southern Floodplain Forest - Occurs on the floodplains of rivers. Hardwoods dominate with a variety of species present. Composition of species varies with the amount of moisture.
- Maritime Forest - Develops on the lee side of stable sand dunes protected from the ocean. Live oak is an indicator species along with pine, cedar, yaupon, holly, and laurel oak. Deciduous hardwoods may be present where forest is mature.
- Pocosins - Lowland forest community that develops on highly organic soils that are seasonally flooded. Characterized by plants adapted to drought and acidic soils low in nutrients. Pond pine is the dominant tree with dense layer of evergreen shrubs. Strongly influenced by fire.
- Cypress Tupelo Swamp Forest - Occurs in the lowest and wettest areas of floodplains. Dominated by bald cypress and tupelo.
- Freshwater Marsh - Occurs upstream from tidal marshes and downstream from non-tidal freshwater wetlands. Cattails, sedges, and rushes are present.
- Salt Marsh - Regularly flooded, tidally influenced areas dominated by salt-tolerant grasses. Saltwater cordgrass is a characteristic species. Tidal mud flats may be present during low tide.
- Salt Shrub Thicket - High areas of salt marshes and beach areas behind dunes. Subjected to salt spray and periodic saltwater flooding. Dominated by salt resistant shrubs.
- Dunes/Beaches - Zones from the ocean shore to the maritime forest. Subjected to sand, salt, wind, and water.
- Ponds and Lakes - Low depressional areas where water table reaches the surface or where ground is impermeable. In ponds rooted plants can grow across the bottom. Fish populations in these ponds include redear, bluegill, largemouth bass, and channel catfish.
- Open Water - Marine and estuarine waters as well as all underlying bottoms below the intertidal zone.

MCB, Camp Lejeune covers approximately 150,000 acres or 234 square miles. Marine and estuarine open water account for 26,000 acres and terrestrial and palustrine land account for 85,000 acres. Forests are predominant as terrestrial cover and pine forest is the dominant habitat type. A total of 21,000 acres of the pine forest is loblolly pine, 7700 acres are dominated by longleaf pine

forest, and 3600 acres are dominated by pond pine forest. These pine forests include natural subcommunities that are maintained by fire.

In addition to the pine forest, mixed pine\hardwood forest is present on MCB, Camp Lejeune and accounts for 15,900 acres. An additional 12,100 acres are covered by hardwood forest. Of the wetlands present, estuarine marsh accounts for 700 acres; open freshwater accounts for 200 acres; and dune, beach, and brackish marsh accounts for 2200 acres. Industrial, infrastructure, and administrative areas make up 10,000 acres and artillery impact areas and buffer zones account for 11,000 acres (LeBlond, 1994). The base contains 80 miles of tidal streams, 21 miles of marine shoreline, and 12 freshwater ponds. The soil types range from sandy loams to fine sand and muck, with the dominant series being sandy loam (USMC,1987).

The base drains primarily to the New River via its tributaries. These tributaries include Northeast Creek, Southwest Creek, Cogdels Creek, Wallace Creek, Frenchs Creek, Bear Head Creek, Brinson Creek, Edwards Creek, and Duck Creek. Site-specific information regarding surface water and drainage features is presented in Section 2.0.

Forested areas within the military reservation are actively managed for timber. Game species are also managed for hunting and ponds are maintained for fishing. Game species managed include wild turkey, white-tailed deer, black bear, grey and fox squirrels, bobwhite quail, eastern cottontail and marsh rabbits, raccoons, and wood ducks. About 150 acres are maintained for wildlife food plots.

1.2.8.2 Sensitive Environments

Two areas on MCB, Camp Lejeune have been registered as designated Natural Areas within the North Carolina Natural Heritage Program. These two areas, which encompass 141 acres, are the Longleaf Pine Natural Area and the Wallace Creek Swamp Natural Area. In addition, 12 other Natural Areas have been recommended for inclusion in the registry.

These Natural Areas contain some of the finest examples of natural communities in North Carolina and support many rare species. A few of these community types are globally rare. The Calcareous Coastal Fringe Forest on the 100-acre midden at Corn Landing is the only known extant example of this community type. Camp Lejeune contains some of the best examples of the following globally-rare, natural community types: Cypress Savanna, Depression Meadow, and Small Depression Pond. The Maritime Evergreen Forest hammocks between Cedar Point and Shell Point are connected by shell tombolos and appear to be a very rare geological formation.

The NC DEHNR's Division of Environmental Management (DEM) has developed guidance pertaining to activities that may impact wetlands (NC DEHNR, 1992). In addition, certain activities affecting wetlands are also regulated by the U.S. Army Corps of Engineers.

The U.S. Fish and Wildlife Service (FWS) has prepared National Wetlands Inventory (NWI) maps for the MCB, Camp Lejeune area. Through stereoscopic analysis of high altitude aerial photographs, wetlands were identified based upon vegetation, visible hydrology, and geography in accordance with Classification of Wetland and Deep-Water Habitats of the United States (Cowardin, et al., 1979). The NWI maps are intended for an initial identification of wetland areas and are not meant to replace an actual wetland delineation survey that may be required by Federal, state and local regulatory agencies.

Site-specific wetland delineations were not conducted at Sites 36, 43, 44, 54, and 86; however, potential wetland areas were noted during the field habitat evaluation. Information regarding potential wetland areas was transferred to the site-specific biohabitat maps provided in Section 2.0. Information regarding sensitive natural areas was reviewed during map preparation and has been transferred to the maps, if applicable.

1.2.8.3 Threatened and Endangered Species

Certain species have been granted protection by the FWS under the Federal Endangered Species Act (16 U.S.C. 1531-1543), and by the North Carolina Wildlife Resources Commission, under the North Carolina Endangered Species Act (G.S. 113-331 to 113-337). The protected species fall into one of the following status classifications: federal or state endangered, threatened or candidate species; state special concern; state significantly rare; or state watch list. While only the federal or state threatened or endangered and state special concern species are protected from certain actions, the other classified species may have protection in the future.

Surveys have been conducted to identify threatened and endangered species at MCB, Camp Lejeune and several programs are underway to manage and protect them. Table 1-4 lists federally protected species present at the base and their protected classification. Of these species, the red-cockaded woodpecker, American alligator, and sea turtles are protected by specific regulatory programs.

The red-cockaded woodpecker requires a mature, living longleaf or loblolly pine environment. The birds live in family groups and young are raised cooperatively. At MCB, Camp Lejeune, 2,512 acres of habitat have been identified and marked for protection. Approximately 3,300 acres are in actively managed red-cockaded woodpecker colonies. Research on the bird at MCB, Camp Lejeune began in 1985 and information has been collected to determine home ranges, population size and composition, reproductive success, and habitat use. An annual roost survey is conducted and 36 colonies of birds have been located.

The American alligator is considered a state special concern specie. It is found in freshwater, estuarine, and saltwater wetlands in MCB, Camp Lejeune. Base wetlands are maintained and protected for alligators; signs have been posted where alligators are known to live. Annual surveys of Wallace, Southwest, French, Duck, Mill, and Stone Creeks have been conducted since 1977 to identify alligators and their habitats on base.

Two protected sea turtles, the Atlantic loggerhead and Atlantic green turtle, nest on Onslow Beach at MCB, Camp Lejeune. The green turtle was found nesting in 1980; this sighting was the first time the species had been observed nesting north of Georgia. The turtle returned to nest in 1985. Turtle nests on the beach are surveyed and protected, turtles are tagged, and annual turtle status reports are issued.

Three bird species, piping plover, Bachmans sparrow, and peregrine falcon have also been identified during surveys at MCB, Camp Lejeune. The piping plover is a shore bird. Piping plovers prefer beaches with broad open sandy flats above the high tide line and feed along the edge of incoming waves. Like the piping plover, Bachmans sparrows have very specific habitat requirements. The sparrows live in open stretches of pines with grasses and scattered shrubs for ground cover. Bachmans sparrows were observed at numerous locations throughout southern portion MCB, Camp Lejeune.

In addition to the protected species that breed or forage at MCB, Camp Lejeune, several protected whales migrate through the coastal waters off the base during spring and fall. These include the Atlantic right whale, finback whale, sei whale, and sperm whale. Before artillery or bombing practice is conducted in the area, aerial surveys are made to assure that whales are not present in the impact areas.

A natural heritage resource study was conducted at MCB, Camp Lejeune (LeBlond, 1994) to identify threatened or endangered plants and areas of significant natural interest. During the resource study 55 rare plant species were documented from Camp Lejeune. These include 1 specie that is classified as Federal Endangered, 1 specie that is classified as Federally Threatened, 9 that are candidates for federal listing as Endangered or Threatened, 4 that are listed as Endangered or Threatened in the State of North Carolina, and 27 species that are State Rare or State Special Concern. These species are summarized on Table 1-4. In addition, species that are candidates for state listing or are on the North Carolina state watch list were noted.

1.2.9 Land Use Demographics

MCB, Camp Lejeune encompasses an area of approximately 234 square miles. The Installation border is approximately 70 miles, including 21 miles of ocean front and Intracoastal Waterway. Recently, MCB, Camp Lejeune acquired approximately 41,000 additional acres in the Greater Sandy Run area. Table 1-5 provides a breakdown of land uses within the developed portion of the facility.

Land use within MCB, Camp Lejeune is influenced by topography and ground cover, environmental policy, and base operational requirements. Much of the land within MCB, Camp Lejeune consists of freshwater swamps that are wooded and largely unsuitable for development. In addition, 3,000 acres of sensitive estuary and other areas set aside for the protection of threatened and endangered species are to remain undeveloped. Operational restrictions and regulations, such as explosive quantity safety distances, impact-weighted noise thresholds, and aircraft landing and clearance zones, may also greatly constrain and influence development (Master Plan, 1988).

The combined military and civilian population of the MCB, Camp Lejeune and Jacksonville area is approximately 112,000. Nearly 90 percent of the surrounding population resides within urbanized areas. The presence of MCB, Camp Lejeune has been the single greatest factor contributing to the rapid population growth of Jacksonville and adjacent communities, particularly during the period from 1940 to 1960.

1.2.9.1 MCAS, New River

MCAS, New River encompasses 2,772 acres and is located in the northwestern portion of the MCB, Camp Lejeune complex. MCAS, New River includes air support activities, troop housing, and personnel support facilities that surround the aircraft operations and maintenance areas. The air station primarily functions as a helicopter base, however, an increasing contingent of fixed-wing aircraft are also supported. Its present mission is to maintain and operate facilities that provide services and material to sustain operations of Marine Air Groups (MAG) 26 and 29, the two tenant commands. MCAS, New River also maintains a number of other activities and units as designated by the Commandant of the Marine Corps and the Chief of Naval Operations.

1.2.10 Meteorology

Although coastal North Carolina lacks distinct wet and dry seasons, there is some seasonal variation in average precipitation. July tends to receive the most precipitation, and rainfall amounts during summer are generally the greatest. Daily showers during the summer are not uncommon, nor are periods of one or two weeks without rain. Convective showers and thunderstorms contribute to the variability of precipitation during the summer months. October tends to receive the least amount of precipitation, on average. Throughout the winter and spring precipitation occurs primarily in the form of migratory low pressure storms. MCB, Camp Lejeune's average yearly rainfall is 52.4 inches. Table 1-6 presents a climatic summary of data collected during 35 years (January 1955 to December 1990) of observations at MCAS New River.

Coastal Plain temperatures are moderated by the proximity of the Atlantic Ocean, which effectively reduces the average daily fluctuation of temperature. Lying 50 miles offshore at its nearest point, the Gulf Stream tends to have little direct effect on coastal temperatures. The southern reaches of the cold Labrador Current offset any warming effect the Gulf Stream might otherwise provide.

MCB, Camp Lejeune experiences hot and humid summers; however, ocean breezes frequently produce a cooling effect. The winter months tend to be mild, with occasional brief cold spells. Average daily temperatures range from 34°F to 54°F in January, the coldest month, and 72°F to 89°F in July, the hottest month. The average relative humidity, between 78 and 89 percent, does not vary greatly from season to season.

Observations of sky conditions indicate yearly averages of approximately 112 days clear, 105 partly cloudy, and 148 cloudy. Measurable amounts of rainfall occur 118 days per year, on the average. Prevailing winds are generally from the south-southwest 10 months of the year and from the north-northwest during September and October. The average wind speed at MCAS, New River is seven miles per hour.

1.3 Background and Setting of Site 44

The following section provides both the location and setting of Site 44. A brief summary of past waste disposal activities at Site 44 is also provided within this section.

1.3.1 Site Location and Setting

The Jones Street Dump (Site 44) encompasses approximately 5 acres and is situated within the operations area of MCAS New River (see Figure 1-1). Vehicle access to the site is via Baxter Street, from Curtis Road. Site 44 is located at the northern terminus of Baxter Street, behind base housing units along Jones Street.

The site is partially surrounded by a six-foot cyclone fence, a portion of the site lies to the east of the fenced compound. The site is bordered to the north and west by Edwards Creek, to the south by base housing units along Jones Street, and to the east by woods and an unnamed tributary to Edwards Creek. Edwards Creek flows east from the study area toward Site 43, which is located about 2,000 feet to the east of Site 44. Figure 1-5 presents a site map of the Jones Street Dump.

A majority of the site is comprised of a gently dipping open field that slopes toward Edwards Creek. The field is covered with high grass, weeds, and small pine trees that are less than two inches in diameter. Surrounding the open field is a mature wooded area with dense understory.

1.3.2 Site History

Site 44 was reportedly in operation during the 1950s. Although the quantity of waste is not known, the IAS report stated that debris, cloth, lumber, and paint cans were disposed of at the site (WAR, 1983). The IAS report also referred to minor quantities of potentially hazardous waste as having been disposed of at Site 44, however, the report made no mention of what type of waste that included.

1.4 Previous Investigations

The following subsections describe previous investigation activities at OU No.6, Site 44. These investigations include an Initial Assessment Study (IAS), and a Site Inspection (SI).

1.4.1 Initial Assessment Study

In 1983, an IAS was conducted at MCB, Camp Lejeune and MCAS, New River by Water and Air Research, Inc. (WAR). The IAS evaluated the potential hazards at various sites throughout the facility, including Site 44. The IAS was based upon review of historical records, aerial photographs, a site visit, and personnel interviews. The IAS report suggested that, due to the negligible quantity of inert material reportedly disposed at Site 44, further investigations were not warranted. Therefore, a Confirmation Study was not recommended for the study area.

1.4.2 Site Inspection

In 1991, Baker conducted an SI at Site 44 (Baker, 1994a). The SI consisted of the following field activities: the installation and sampling of three monitoring wells (44-GW01, 44-GW02, and 44-GW03); the collection of two soil samples from each monitoring well test boring (one near the surface and one just above the water table); the collection of two soil samples from six additional soil borings; and the collection of two surface water and sediment samples from Edwards Creek. Table 1-7 provides well construction details of the three shallow monitoring wells installed during the SI at Site 44. Figure 1-6 identifies the specific SI sampling locations.

The following subsections briefly describe the results and conclusions of the SI at Site 44. Tables 1-8 through 1-12 present laboratory analytical results from the SI.

1.4.2.1 Soil Investigation

Lead, chromium, manganese, and other heavy metals were detected above twice the average base-specific background levels at Site 44. Other inorganics such as arsenic were also present at concentrations greater than twice their average base-specific background levels. The primary organic contaminants detected on site were polynuclear aromatic hydrocarbons (PAH) compounds. The subsurface soil sample from monitoring well test boring 44-GW03 had the highest concentrations of PAHs among the nine sampling locations. The total PAH concentration in the subsurface sample at location 44-GW03 was greater than 2,000 µg/kg. The pesticides 4,4'-DDD and 4,4'-DDE were detected in two separate samples at concentrations of 30 and 48 µg/kg,

respectively. Tables 1-8 and 1-9 present positive detections of organic and inorganic soil analytical results from the SI at Site 44, respectively. None of the organic compounds detected in soils at Site 44 were widely distributed.

Debris such as metal, cement, brick, wood, and plastic was encountered during soil boring activities at Site 44. In addition, a dark soil was encountered at one location that had an odor similar to motor oil (Baker, 1994).

1.4.2.2 Groundwater Investigation

The groundwater sample obtained from monitoring well 44-GW01 exhibited low levels of the organic compounds carbon disulfide (6 µg/L), toluene (3J µg/L), and ethylbenzene (2J µg/L). Low levels of organic PAH compounds were detected in the groundwater at 44-GW03, the maximum PAH concentration was that of naphthalene (62 µg/L). At this same location, the subsurface soil sample also exhibited PAH contamination. The SI report suggested that PAHs may have adhered to suspended material in the groundwater sample and then were reflected in the groundwater analysis. Table 1-10 presents a positive detection summary of organic compounds in groundwater collected during the SI at Site 44.

Various inorganics were detected above state and federal drinking water standards in groundwater samples obtained from the three SI monitoring wells. Elevated levels of aluminum, chromium, iron, lead, and manganese were detected in all three monitoring wells. However, studies conducted at several sites throughout MCB, Camp Lejeune have also exhibited concentrations of total metals in excess of water quality standards. These elevated concentrations of total metals have been correlated with sample turbidity. The results of these analyses tend to reflect the presence of suspended material in groundwater samples rather than depict true groundwater conditions. Table 1-10 presents the inorganic groundwater analytical results from the SI at Site 44.

1.4.2.3 Surface Water and Sediment Investigation

Two surface water samples were collected from Edwards Creek (refer to Figure 1-6). The volatile organic compounds (VOCs) carbon disulfide (18 µg/L) and 1,1,2-trichloroethane (3 J µg/L) were detected in samples 44-SW01 and 44-SW02, respectively. Inorganics were detected in both surface water samples. Chromium, copper, iron, lead, manganese, and zinc were detected at concentrations that exceeded surface water quality standards in at least one of the two samples. Table 1-11 presents a summary of positive detections for both surface water samples.

Two sediment samples were also collected from Edwards Creek, at the surface water stations. The pesticides 4,4'-DDE and 4'4'-DDD were detected in both sediment samples at maximum concentrations of 1,000 µg/kg. The samples also exhibited positive detections of copper, lead, and zinc above screening values. Table 1-12 presents the positive analytical results from the sediment investigation of Edwards Creek.

1.4.2.4 Recommendations of the Site Inspection

Based on the findings of the SI, an RI/FS, including a human health and ecological risk assessment, was recommended to further evaluate the nature and extent of soil, sediment, surface water, and groundwater contamination. Also, further characterization of upgradient groundwater and background soil, surface water, and sediment was recommended.

1.5 Remedial Investigation Objectives

The purpose of this section is to define the RI objectives intended to characterize past waste disposal activities at Site 44, assess potential impacts to public health and environment, and provide feasible alternatives for consideration during preparation of the ROD. The remedial objectives presented in this section have been identified through review and evaluation of existing background information, assessment of potential risks to public health and environment, and consideration of feasible remediation technologies and alternatives. As part of the remedial investigation at Site 44, soil, groundwater, surface water, and sediment investigations were conducted. The information gathered during these investigations was intended to fill previously existing data gaps and employed to generate human health and ecological risk values. Table 1-13 presents the RI objectives identified for Site 44. In addition, the table provides a general description of the study or investigation efforts that were conducted to obtain the requisite information.

1.6 References

Atlantic Division, Naval Facilities Engineering Command. January 1988. Camp Lejeune Complex Master Plan and Capital Improvements Plan Update. Prepared for the Commanding General, Marine Corps Base, Camp Lejeune, North Carolina.

Baker Environmental, Inc. January 1994. Site Inspection Report - Site 44, Jones Street Dump. Final. Prepared for the Department of the Navy, Naval Facilities Engineering Command, Atlantic Division, Norfolk, Virginia.

Baker Environmental, Inc. December 1994. Remedial Investigation/Feasibility Study Work Plan for Operable Unit No. 6 (Sites 36, 43, 44, 54, and 86), Marine Corps Base Camp Lejeune, North Carolina. Final. Prepared for the Department of the Navy, Naval Facilities Engineering Command, Atlantic Division, Norfolk, Virginia.

Baker Environmental, Inc. May 1995. Site Management Plan for Marine Corps Base Camp Lejeune, North Carolina. Draft. Prepared for the Department of the Navy, Naval Facilities Engineering Command, Atlantic Division, Norfolk, Virginia.

Cardinell, A.P., Berg, S.A., and Lloyd, O.B. 1993. Hydrogeologic Framework of U.S. Marine Corps Base at Camp Lejeune, North Carolina: U.S. Geological Survey Water Resources Investigation Report. Report No. 93-4049.

Cowardin, Lewis M., Virginia Carter, Francis C. Golet, and Edward T. LaRoe. December 1979. Classification of Wetlands and Deepwater Habitats of the United States. Performed for U.S. Department of the Interior, Fish and Wildlife Service, Office of Biological Services - FWS/OBS-79/31.

Environmental Science and Engineering, Inc. (ESE) 1990. Site Summary Report. Final. Marine Corps Base, Camp Lejeune, North Carolina. Prepared for the Department of the Navy, Naval Facilities Engineering Command, Atlantic Division, Norfolk, Virginia. ESE Project No. 49-02036.

Environmental Science and Engineering, Inc. (ESE) 1988. Characterization Step Report for Hadnot Point Industrial Area. Marine Corps Base, Camp Lejeune, North Carolina. Prepared for the Department of the Navy, Naval Facilities Engineering Command, Atlantic Division, Norfolk, Virginia. ESE Project No. 49-02036-0150.

Federal Facilities Agreement (FFA) Between United States Environmental Protection Agency, Region IV, The North Carolina Department of Environment, Health, and Natural Resources, and the United States Department of Navy for Marine Corps Base, Camp Lejeune and Marine Corps Air Station, New River, North Carolina. December 1989.

Harned, D.A., Lloyd, O.B., Jr., and Treece, M.W., 1989. Assessment of Hydrologic and Hydrogeologic Data at Camp Lejeune Marine Corps Base, North Carolina: U.S. Geological Survey Water Resources Investigation. Report 89-4096, p. 64.

LeBlond, Richard J., John O. Fussell, and Alvin L. Broswell. February 1994. Inventory of Rare Species, Natural Communities, and Critical Areas of the Camp Lejeune Marine Corps Base, North Carolina. North Carolina Natural Heritage Program, Division of Parks and Recreation, Department of Environment, Health, and Natural Resources, Raleigh, North Carolina.

North Carolina Department of Environment, Health, and Natural Resources (NC DEHNR) May 1992. Interim Guidance for Wetlands Protection. Division of Environment, Water Quality Section.

U.S. Department of the Interior (USDI). March 1982. National Wetland Inventory Map, Camp Lejeune, N.C. Fish and Wildlife Service.

U.S. Marine Corps, MCB, Camp Lejeune (USMC). 1987. Multiple-Use Natural Resources Management Plan. Fish and Wildlife Division, Environmental Management Department, Marine Corps Base, Camp Lejeune, North Carolina.

Water and Air Research, Inc. (WAR) April 1983. Initial Assessment Study of Marine Corps Base Camp Lejeune, North Carolina. Prepared for the Department of the Navy, Naval Energy and Environmental Support Activity, Port Hueneme, California.

SECTION 1.0 TABLES

TABLE 1-1

GEOLOGIC AND HYDROGEOLOGIC UNITS OF
 NORTH CAROLINA'S COASTAL PLAIN
 REMEDIAL INVESTIGATION, CTO-0303
 MCAS, NEW RIVER, NORTH CAROLINA

Geologic Units			Hydrogeologic Units
System	Series	Formation	Aquifer and Confining Unit
Quaternary	Holocene/Pleistocene	Undifferentiated	Surficial aquifer
Tertiary	Pliocene	Yorktown Formation ⁽¹⁾	Yorktown confining unit
	Miocene	Eastover Formation ⁽¹⁾	Yorktown Aquifer
		Pungo River Formation ⁽¹⁾	Pungo River confining unit
		Pungo River Formation ⁽¹⁾	Pungo River Aquifer
		Belgrade Formation ⁽²⁾	Castle Hayne confining unit
	Oligocene	River Bend Formation	Castle Hayne Aquifer
	Eocene	Castle Hayne Formation	Beaufort confining unit ⁽³⁾
	Paleocene	Beaufort Formation	Beaufort Aquifer
Cretaceous	Upper Cretaceous	Peedee Formation	Peedee confining unit
			Peedee Aquifer
		Black Creek and Middendorf Formations	Black Creek confining unit
			Black Creek Aquifer
		Cape Fear Formation	Upper Cape Fear confining unit
			Upper Cape Fear Aquifer
	Lower Cape Fear confining unit		
		Lower Cape Fear Aquifer	
	Lower Cretaceous ⁽¹⁾	Unnamed deposits ⁽¹⁾	Lower Cretaceous confining unit
Lower Cretaceous Aquifer ⁽¹⁾			
Pre-Cretaceous basement rocks		--	--

Note:

- (1) Geologic and hydrologic units probably not present beneath MCB, Camp Lejeune.
- (2) Constitutes part of the surficial aquifer and Castle Hayne confining unit in the study area.
- (3) Estimated to be confined to deposits of Paleocene age in the study area.

Source: Harned et al., 1989.

TABLE 1-2

SUMMARY OF HYDRAULIC PROPERTIES
 UNRELATED SITE INVESTIGATIONS
 REMEDIAL INVESTIGATION, CTO-0303
 MCAS, NEW RIVER, NORTH CAROLINA

Well No.	Hydraulic Conductivity Falling Head Test		Hydraulic Conductivity Rising Head Test		Transmissivity	Storativity
	ft/day	cm/sec	ft/day	cm/sec	gal/day/ft	
MW-30A	1.18	4.16E-04	1.5	5.31E-04	--	--
MW-31A	0.346	1.22E-04	0.269	9.51E-05	--	--
MW-35A	0.119	4.20E-05	0.116	4.06E-05	--	--
MW-32B	6.22	2.20E-03	5.15	1.82E-03	--	--
MW-36B	2.91	1.03E-03	3.2	1.13E-03	--	--
MW-37B	7.06	2.49E-03	6.44	2.27E-03	--	--
GWD-1	6.8	2.40E-03	6.03	2.13E-03	--	--
122MW-3	0.25	8.80E-05	0.015	5.30E-06	--	--
122MW-5	0.47	1.70E-04	0.034	1.20E-05	--	--
122MW-12	0.068	2.40E-05	0.0085	3.00E-06	--	--
MW-13 ⁽¹⁾	0.0554	1.96E-05	0.0032	1.13E-06	--	--
MW-14 ⁽¹⁾	0.188	6.62E-05	7.26E-04	2.56E-07	--	--
MW-3 ⁽²⁾	--	--	0.75	2.60E-04	--	--
MW-4 ⁽²⁾	--	--	0.27	9.50E-05	--	--
MW-11 ⁽²⁾	--	--	0.37	1.30E-04	--	--
MW-21 ⁽²⁾	--	--	0.46	1.60E-04	5.5	0.028
RW-1 ⁽²⁾	--	--	--	--	54	--
MW-18 ⁽²⁾	--	--	--	--	790	0.014

Note: All data compiled from unrelated Baker Investigations with the MCAS, New River operations area.

⁽¹⁾ AS 527

⁽²⁾ Campbell Street Fuel Farm
 A = Upper Surficial Aquifer
 B = Lower Surficial Aquifer

TABLE 1-3

HYDRAULIC PROPERTY ESTIMATES OF THE CASTLE HAYNE AQUIFER
 REMEDIAL INVESTIGATION, CTO-0303
 MCAS, NEW RIVER, NORTH CAROLINA

Hydraulic Properties	USGS Phase I Study ⁽¹⁾	USGS Aquifer Test ⁽²⁾	ESE, Inc. ⁽³⁾	DEHNR Aquifer Test ⁽⁴⁾	RASA Estimate ⁽⁵⁾
Aquifer transmissivity (cubic foot per day per square foot times foot of aquifer thickness)	4,300 to 24,500 average 9,500	1,140 to 1,325	820 to 1,740 average 1,280	900	10,140 to 26,000
Aquifer hydraulic conductivity (foot per day)	14 to 82 average 35	20 to 60	--	18 to 91 average 54	45 to 80 average 65
Aquifer storage coefficient (dimensionless)	--	0.0002 to 0.00022	0.0005 to 0.001 average 0.0008	0.0019	--
Confining-unit vertical hydraulic conductivity (foot per day)	--	0.03 to 0.41	0.0014 to 0.051 average 0.0035	--	--

Note:

- (1) Analysis of specific capacity data from Harned and others (1989).
- (2) Aquifer test at well HP-708.
- (3) Aquifer test at Hadnot Point well HP-462 from Environmental Sciences and Engineering, Inc. (1988).
- (4) Unpublished aquifer test data at well X24s2x, from DEHNR well records (1985).
- (5) Transmissivities based on range of aquifer thickness and average hydraulic conductivity from Winner and Coble (1989).

Source: Cardinell, et al., 1993.

TABLE 1-4

**PROTECTED SPECIES WITHIN MCB, CAMP LEJEUNE
REMEDIAL INVESTIGATION, CTO-0303
MCAS, NEW RIVER, NORTH CAROLINA**

Species	Protected Classification
Animals:	
American alligator (<i>Alligator mississippiensis</i>)	SC
Bachmans sparrow (<i>Aimophila aestivalis</i>)	FCan, SC
Green (Atlantic) turtle (<i>Chelonia m. mydas</i>)	T(f), T(s)
Loggerhead turtle (<i>Caretta caretta</i>)	T(f), T(s)
Peregrine falcon (<i>Falco peregrinus</i>)	E(f), E(s)
Piping plover (<i>Charadrius melodus</i>)	T(f), T(s)
Red-cockaded woodpecker (<i>Picoides borealis</i>)	E(f), E(s)
Southern Hognose Snake (<i>Heterodon simus</i>)	FCan, SR
Diamondback Terrapin (<i>Malaclemys terrapin</i>)	FCan, SC
Carolina Gopher Frog (<i>Rana capito capito</i>)	FCan, SC
Cooper's Hawk (<i>Accipiter cooperii</i>)	SC
Eastern Diamondback Rattlesnake (<i>Crotalus adamanteus</i>)	SR
Eastern Coral Snake (<i>Micrurus fulvius</i>)	SR
Pigmy Rattlesnake (<i>Sistrurus miliarius</i>)	SR
Black Bear (<i>Ursus americanus</i>)	SR
Plants:	
Rough-leaf loosestrife (<i>Lysimachia asperulifolia</i>)	E(f), E(s)
Seabeach Amaranth (<i>Amaranthus pumilus</i>)	T(f), T(s)
Chapman's Sedge (<i>Carex chapmanii</i>)	FCan
Hirst's Witchgrass (<i>Dichanthelium</i> sp.)	FCan
Pondspice (<i>Litsea aestivalis</i>)	FCan
Boykin's Lobelia (<i>Lobelia boykinii</i>)	FCan
Loose Watermilfoil (<i>Myriophyllum laxum</i>)	FCan, T(s)
Awned Meadowbeauty (<i>Rhexia aristosa</i>)	FCan, T(s)
Carolina Goldenrod (<i>Solidago pulchra</i>)	FCan, E(s)
Carolina Asphodel (<i>Tofieldia glabra</i>)	FCan
Venus Flytrap (<i>Dionaea muscipula</i>)	FCan
Flaxleaf Gerardia (<i>Agalinis linifolia</i>)	SR
Pinebarrens Goober Grass (<i>Amphicarpum purshii</i>)	SR
Longleaf Three-awn (<i>Aristida palustris</i>)	SR
Pinebarrens Sandreed (<i>Calamovilfa brevipilis</i>)	E(s)
Warty Sedge (<i>Carex verrucosa</i>)	SR
Smooth Sawgrass (<i>Cladium mariscoides</i>)	SR
Leconte's Flatsedge (<i>Cyperus lecontei</i>)	SR
Erectleaf Witchgrass (<i>Dichanthelium erectifolium</i>)	SR
Horsetail Spikerush (<i>Eleocharis equisetoides</i>)	SR
Sand Spikerush (<i>Eleocharis montevidensis</i>)	SR

TABLE 1-4 (Continued)

PROTECTED SPECIES WITHIN MCB, CAMP LEJEUNE
 REMEDIAL INVESTIGATION, CTO-0303
 MCB, CAMP LEJEUNE, NORTH CAROLINA

Species	Protected Classification
Flaxleaf Seedbox (<i>Ludwigia linifolia</i>)	SR
Torrey's Muhley (<i>Muhlenbergia torreyana</i>)	E(s)
Southeastern Panic Grass (<i>Panicum tenerum</i>)	SR
Spoonflower (<i>Peltandra sagittifolia</i>)	SR
Shadow-witch (<i>Ponthieva racemosa</i>)	SR
West Indies Meadowbeauty (<i>Rhexia cubensis</i>)	SR
Pale Beakrush (<i>Rhynchospora pallida</i>)	SR
Longbeak Baldsedge (<i>Rhynchospora scirpoides</i>)	SR
Tracy's Beakrush (<i>Rhynchospora tracyi</i>)	SR
Canby's Bulrush (<i>Scirpus tuberculatus</i>)	SR
Slender Nutrush (<i>Scleria minor</i>)	SR
Lejeune Goldenrod (<i>Solidago</i> sp.)	SR
Dwarf Bladderwort (<i>Utricularia olivacea</i>)	T(s)
Elliott's Yellow-eyed Grass (<i>Xyris elliotii</i>)	SR
Carolina Dropseed (<i>Sporobolus</i> sp.)	T(s)

Legend:

- E(f) = Federal Endangered
- T(f) = Federal Threatened
- Fcan = Candidate for Federal Listing
- E(s) = State Endangered
- T(s) = State Threatened
- SC = State Special Concern
- SR = State Rare

Source: LeBlond, 1994

TABLE 1-5

**LAND UTILIZATION WITHIN DEVELOPED AREAS OF MCB, CAMP LEJEUNE
REMEDIAL INVESTIGATION, CTO-0303
MCAS, NEW RIVER, NORTH CAROLINA**

Geographic Area	Operation	Training (Instruc.)	Maintenance	Supply/ Storage	Medical	Admin- istration	Family Housing	Troop Housing	CM	CO	Recreation	Utility	Total
Hadnot Point	31 (2.9)	15 (1.4)	154 (14.3)	157 (14.4)	10 (0.9)	122 (11.3)	22 (2.0)	196 (18.1)	115 (10.7)	36 (3.3)	182 (16.9)	40 (3.7)	1,080 (100)
Paradise Point	1 (0)		3 (0.4)	1 (0)			343 (34)	19 (1.9)	31 (3.1)		610 (60.4)	2 (0.2)	1,010 (100)
Berkeley Manor/ Watkins							406 (80)		41 (8.1)	1 (0.2)	57 (11.2)	2 (0.5)	507 (100)
Midway Park		1 (0.4)		2 (0.7)		2 (0.7)	248 (92.2)		8 (3.0)	3 (1.1)	4 (1.5)	1 (0.4)	269 (100)
Tarawa Terrace I and II			3 (0.5)			1 (0.3)	428 (77.4)		55 (9.9)	11 (2.0)	47 (8.5)	8 (1.4)	553 (100)
Knox Trailer							57 (100)						
French Creek	8 (1.4)	1 (0.2)	74 (12.7)	266 (45.6)	3 (0.5)	7 (1.2)		122 (20.9)	22 (3.8)	6 (1.0)	74 (12.7)		583 (100)
Courthouse Bay		73 (28.6)	28 (10.9)	14 (5.5)		12 (4.7)	12 (4.7)	43 (16.9)	15 (5.9)	4 (1.6)	43 (16.9)	11 (4.3)	255 (100)
Onslow Beach	6 (9.8)	1 (1.6)	3 (4.8)	2 (3.2)	1 (1.6)	2 (3.2)		2 (3.2)	12 (19.3)		25 (40.3)	8 (13.0)	62 (100)
Rifle Range		1 (1.3)	1 (1.3)	7 (8.8)	1 (1.3)	5 (6.3)	7 (8.8)	30 (37.5)	5 (6.3)	1 (1.3)	9 (11.3)	13 (16.3)	80 (100)
Camp Geiger	4 (1.9)	15 (6.9)	19 (8.8)	50 (23.1)		23 (10.6)		54 (25.0)	27 (12.5)	2 (1.0)	16 (7.4)	6 (2.8)	216 (100)
Montford Point	6 (2.6)	48 (20.5)	2 (0.9)	4 (1.7)	2 (0.9)	9 (3.9)		82 (35.2)	20 (8.6)	1 (0.4)	49 (21.0)	10 (4.3)	233 (100)
Base-Wide Misc.	1 (0.8)			87 (68.0)		3 (2.3)			19 (14.8)			18 (14.1)	128 (100)
TOTAL	57 (1.)	155 (3.1)	287 (5.7)	590 (11.7)	17 (0.38)	186 (3.7)	1,523 (30.2)	548 (10.8)	370 (7.4)	65 (1.3)	1,116 (22.2)	119 (2.4)	5,033 (100)

Notes:

Numbers without parentheses represent total acres.
Numbers within parentheses represent percentage of total acres.
Source: Master Plan, 1988

TABLE 1-6

CLIMATIC DATA SUMMARY
 MARINE CORPS AIR STATION, NEW RIVER
 REMEDIAL INVESTIGATION, CTO-0303
 MCAS, NEW RIVER, NORTH CAROLINA

	Precipitation (Inches)			Relative Humidity (Percent)	Temperature (Fahrenheit)			Mean Number of Days With				
	Maximum	Minimum	Average		Maximum	Minimum	Average	Precipitation		Temperature		
								>=0.01"	>=0.5"	>=90F	>=75F	<=32F
January	7.5	1.4	4.0	79	54	34	44	11	2	0	1	16
February	9.1	.9	3.9	78	57	36	47	10	3	0	2	11
March	8	.8	3.9	80	64	43	54	10	3	*	5	5
April	8.8	.5	3.1	79	73	51	62	8	2	1	13	*
May	8.4	.6	4.0	83	80	60	70	10	3	2	25	0
June	11.8	2.2	5.2	84	86	67	77	10	4	7	29	0
July	14.3	4.0	7.7	86	89	72	80	14	5	13	31	0
August	12.6	1.7	6.2	89	88	71	80	12	4	11	31	0
September	12.8	.8	4.6	89	83	66	75	9	3	4	27	0
October	8.9	.6	2.9	86	75	54	65	7	2	*	17	*
November	6.7	.6	3.2	83	67	45	56	8	2	0	7	3
December	6.6	.4	3.7	81	58	37	48	9	2	0	2	12
Annual	65.9	38.2	52.4	83	73	53	63	118	35	39	189	48

Note:

* = Mean no. of days less than 0.5 days

Source: Naval Oceanography Command Detachment, Asheville, North Carolina. Measurements obtained from January 1955 to December 1990.

TABLE 1-7

**SUMMARY OF WELL CONSTRUCTION DETAILS
SITE INSPECTION
SITE 44, JONES STREET DUMP
REMEDIAL INVESTIGATION, CTO-0303
MCAS, NEW RIVER, NORTH CAROLINA**

Well No.	Date Installed	Top of PVC Casing Elevation (feet, above msl) ⁽¹⁾	Ground Surface Elevation (feet, above msl)	Boring Depth (feet, below ground surface)	Well Depth (feet, below ground surface)	Screen Interval Depth (feet, below ground surface)	Sand Pack Interval Depth (feet, below ground surface)	Bentonite Interval Depth (feet, below ground surface)
44-GW01	8/22/91	14.68	11.42	15	14.7	14.7-4.7	3.5-14.7	1.5-3.5
44-GW02	8/21/91	12.90	9.46	12	11.5	11.5-1.5	1.4-11.5	.6-1.4
44-GW03	8/22/91	17.34	14.65	15	14.2	4.2-14.2	3-14.2	1.5-3

Notes:

Horizontal positions are referenced to N.C. State Plane Coordinate System (NAD 27) CF = 0.9999216 from USMC Monument Toney.
Vertical datum NGVD 29.

⁽¹⁾ msl = mean sea level

TABLE 1-8

**DETECTED ORGANIC CONTAMINANTS IN SOIL
SITE INSPECTION
SITE 44, JONES STREET DUMP
REMEDIAL INVESTIGATION, CTO-0303
MCAS, NEW RIVER, NORTH CAROLINA**

Sample Number Sample Depth (feet)	44-GW01-06 6-8'	44-GW03-06 6-8'	44-SB01-02 2-4'	44-SB02-00 0-2'	44-SB02-00DUP 0-2'	44-SB03-00 0-2'	44-SB03-06 6-8'	44-SB04-00 0-2'	44-SB04-00 0-2'
Parameter: Units (µg/kg)									
Volatiles:									
Chloromethane	ND	1 J	ND	ND	ND	ND	ND	ND	ND
Methylene Chloride	ND	ND	ND	ND	ND	ND	ND	ND	16
Carbon Disulfide	ND	ND	ND	ND	ND	ND	ND	2 J	ND
Semivolatiles:									
Benzoic Acid	ND	ND	42 J	39 J	64 J	160 J	67 J	ND	ND
2-Methylnaphthalene	ND	170 J	ND	ND	ND	ND	ND	ND	ND
Acenaphthylene	ND	120 J	ND	ND	ND	ND	ND	ND	ND
Acenaphthene	ND	120 J	ND	ND	ND	ND	ND	ND	ND
Dibenzofuran	ND	100 J	ND	ND	ND	ND	ND	ND	ND
Fluorene	ND	100 J	ND	ND	ND	ND	ND	ND	ND
Phenanthrene	ND	320 J	ND	ND	ND	ND	ND	ND	ND
Fluoranthene	ND	160 J	ND	ND	ND	ND	ND	ND	ND
Pyrene	76 J	100 J	ND	ND	ND	ND	ND	ND	ND
Naphthalene	ND	1,100 J	ND	ND	ND	ND	ND	ND	ND
Pesticides/PCBs:									
4-4'-DDE	ND	ND	ND	30	39	ND	ND	ND	ND
4-4'-DDD	ND	48	ND	ND	ND	ND	ND	ND	ND

Notes:

Concentrations reported in micrograms per kilogram (µg/kg); or parts per billions (ppb).

ND - Not Detected

J - Estimated Value, reported value may not be accurate or precise

DUP - Duplicate

Source: Baker Environmental, Inc. Site Inspection Report, 1991.

TABLE 1-9

**DETECTED INORGANIC CONTAMINANTS IN SOIL
SITE INSPECTION
SITE 44, JONES STREET DUMP
REMEDIAL INVESTIGATION, CTO-0303
MCAS, NEW RIVER, NORTH CAROLINA**

Sample Number Sample Depth (feet)										
Parameter: Units (µg/kg)	44-GW01-00 0-2'	44-GW01-00DUP 0-2'	44-GW01-06 6-8'	44-GW02-00 0-2'	44-GW02-03 3.5-5.5'	44-GW03-00 0-2'	44-GW03-06 6-8'	44-SB01-00 0-2'	44-SB01-02 2-4'	44-SB02-00 0-2'
Inorganics:										
Aluminum	9,480 J	11,100 J	7,050 J	9,570 J	4,050 J	11,000 J	6,610 J	13,100 J	3,930 J	8,870 J
Arsenic	2.0	2.3 J	1.7	3.2 J	ND	10.2	3.0	3.9	ND	1.7
Barium	14.8	16.7	17.9	11.9	6.1	18.3	22.9	16.0	7.4	16.1
Calcium	7,500	11,600	4,730	87.2	ND	7,270	5,660	142	ND	12,200
Chromium	13.0 J	13.9 J	10.0 J	15.5 J	5.6 J	17.4 J	12.6 J	26.2 J	5.3 J	11.1 J
Copper	111 J	44.0 J	25.4 J	27.7 J	6.2 J	62.2 J	127 J	27.6 J	2.3 J	2.8 J
Iron	7,550 J	7,800 J	5,570 J	11,500 J	1,660 J	13,700 J	8,350 J	20,500 J	4,640 J	8,140 J
Lead	7.5	7.0	10.7	7.2	5.5	9.7	44.6	12.0	9.8	13.0
Magnesium	461	590	367	371	129	490	454	510	128	414
Manganese	11.2	12.9	20.4	7.3	3.5	8.4	31.3	10.7	4.0	9.3
Nickel	13.9	8.2	5.4	3.9	3.1	10.3	8.7	4.8	ND	2.9
Potassium	342	424	362	454	ND	454	481	757	ND	313
Selenium	ND	ND	ND	0.89	ND	ND	ND	ND	ND	ND
Vanadium	18.0	20.5	14.7	22.9	5.0	27.4	16.0	39.2	9.0	22.1
Zinc	7.4	8.0	34.9	5.5	3.2	7.0	44.9	10.1	2.8	7.1

Notes:

Concentrations reported in milligrams per kilogram (mg/kg); or parts per billions (ppb).

ND - Not Detected

J - Estimated Value, reported value may not be accurate or precise

DUP - Duplicate

Source: Baker Environmental, Inc. Site Inspection Report, 1991.

TABLE 1-9 (Continued)

**DETECTED INORGANIC CONTAMINANTS IN SOIL
SITE INSPECTION
SITE 44, JONES STREET DUMP
REMEDIAL INVESTIGATION, CTO-0303
MCAS, NEW RIVER, NORTH CAROLINA**

Sample Number Sample Depth (feet)											
Parameter: Units (µg/kg)	44-GW01-00 0-2'	44-SB02- 00DUP 0-2'	44-SB02-06 6-8'	44-SB03-00 0-2'	44-SB03-06 6-8'	44-SB04-00 0-2'	44-SB04-06 6-8'	44-SB05-00 0-2'	44-SB05-07 7-9'	44-SB06-00 0-2'	44-SB06-08 8-10'
Inorganics:											
Aluminum	9,480 J	10,800 J	8,780 J	7,110 J	4,070 J	12,000 J	5,250	13,500	2,140	13,400	1,310
Arsenic	2.0	1.6	ND	4.1	ND	4.9	ND	3.9	ND	2.7	ND
Barium	14.8	18.6	14.1	12.8	7.3	13.4	12.8	20.2	ND	19.3	ND
Calcium	7,500	3,930	77.6	4,180	763	1,600	ND	9,080	ND	3,550	ND
Chromium	13.0 J	12.7 J	9.3 J	10J	4.9 J	19.1 J	7.9	17.9	4.6	16.8	3.0
Copper	111 J	2.7 J	1.5 J	2.0 J	1.9 J	2.6 J	ND	2.8	4.5	5.1	2.5
Iron	7,550 J	8,160 J	3,850 J	7,340 J	2,090 J	16,100 J	2,650	15,500	1,300	8,750	869
Lead	7.5	9.4	9.6	7.3	6.3	12.5	6.1	8.8	4.5	7.9	1.9
Magnesium	461	384	270	293	129	503	231 J	594	102	576	71.9
Manganese	11.2	8.1	5.2	5.8	4.1	9.2	9.4	12.7	ND	16.8	ND
Nickel	13.9	2.5	3.4	2.0	6.1	6.9	ND	ND	ND	ND	ND
Potassium	342	304	364	267	ND	536	276 J	493	ND	617	ND
Selenium	ND	1.1	ND	1.1	ND	ND	ND	ND	ND	ND	ND
Vanadium	18.0	19.1	14.1	14.7	7.0	28.2	ND	27.9	4.3	22.5	2.3
Zinc	7.4	6.3	3.5	4.0	3.4	7.4	4.0 J	10.1	5.6	13.6	5.8

Notes:

Concentrations reported in milligrams per kilogram (mg/kg); or parts per billions (ppb).

ND - Not Detected

J - Estimated Value, reported value may not be accurate or precise

DUP - Duplicate

Source: Baker Environmental, Inc. Site Inspection Report, 1991.

TABLE 1-10

**GROUNDWATER ANALYTICAL RESULTS
SITE INSPECTION
SITE 44, JONES STREET DUMP
REMEDIAL INVESTIGATION, CTO-0303
MCAS, NEW RIVER, NORTH CAROLINA**

Sample Number Sample Depth (feet)	Standards					
Parameter: Units (µg/L)	MCLs ⁽¹⁾	NCWQS ⁽²⁾	44-GW01	44-GW02	44-GW03	44-GW03 DUP
Volatiles:						
Carbon Disulfide	--	--	6	ND	ND	2 J
Toluene	1,000	1,000	3 J	ND	ND	ND
Ethylbenzene	700	29	2 J	ND	ND	ND
Semivolatiles:						
2-Methylnaphthalene	--	--	ND	ND	ND	14
Acenaphthene	--	--	ND	ND	ND	16
Dibenzofuran	--	--	ND	ND	ND	8 J
Phenanthrene	--	--	ND	ND	ND	24
Anthracene	--	--	ND	ND	ND	3J
Fluoranthene	--	--	ND	ND	ND	14
Pyrene	--	--	ND	ND	ND	9J
Benzo(a)anthracene	--	--	ND	ND	ND	3J
Naphthalene	--	--	ND	ND	ND	62
Inorganics:						
Aluminum	--	--	537,000	73,000	183,000	144,000
Arsenic	50	50	570 R	ND	13.0	10.5 J
Barium	2,000	2,000	3,180	315	1,250	1,210
Beryllium	--	--	36.6	1.4	3.0	2.5
Cadmium	5	5	32.0	ND	ND	5.2
Calcium	--	--	191,000	2,430	197,000	201,000
Chromium	100	50	895	126	221	176
Cobalt	--	--	93.2	ND	8.0	7.5

TABLE 1-10 (Continued)

GROUNDWATER ANALYTICAL RESULTS
 SITE INSPECTION
 SITE 44, JONES STREET DUMP
 REMEDIAL INVESTIGATION, CTO-0303
 MCAS, NEW RIVER, NORTH CAROLINA

Sample Number Sample Depth (feet)	Standards					
Parameter: Units (µg/L)	MCLs ⁽¹⁾	NCWQS ⁽²⁾	44-GW01	44-GW02	44-GW03	44-GW03 DUP
Copper	1,300	1,000	313	28.6	86.6	78.6
Iron	300	300	662,000	150,000	147,000	134,000
Lead	15 ⁽³⁾	15	508 R	15.8	481	427
Magnesium	--	--	35,700	3,640	24,100	22,800
Manganese	50	50	1,730	88.0	653	641
Mercury	2	1.1	1.1	ND	ND	ND
Nickel	100	100	486	21.9	42.8	45.6
Potassium	--	--	32,500	4,540	22,300	20,900
Sodium	--	--	7,500	4,060	12,600	13,400
Thallium	--	2	2.7	ND	ND	ND
Vanadium	--	--	759	184	311	266
Zinc	5,000	2,100	2,800 J	87.3 J	1,160 J	1,110 J

Notes:

Concentrations reported in micrograms per liter (µg/L); or parts per billion (ppb).

R - Unreliable result, chemical may or may not be present in the sample.

J - Estimated value, reported value may not be accurate or precise.

ND - Not Detected

(--)- Standard or criteria not available.

DUP - Duplicate

⁽¹⁾ National Primary Drinking Water Regulations, Primary Maximum Contaminant Levels (EPA, 1994)

⁽²⁾ North Carolina Water Quality Standards for Groundwater (Title 15A - Subchapter 2L, 1993)

⁽³⁾ Health Advisories (USEPA, 1993)

Source: Baker Environmental, Inc. Site Inspection Report, 1991.

TABLE 1-11

**SURFACE WATER ANALYTICAL RESULTS
SITE INSPECTION
SITE 44, JONES STREET DUMP
REMEDIAL INVESTIGATION, CTO-0303
MCAS, NEW RIVER, NORTH CAROLINA**

Sample Number	Standards and Criteria		44-SW01	44-SW02
	Parameter: Units (µg/L)	NCWQS ⁽¹⁾		
Volatiles:				
Carbon Disulfide	--	--	18	ND
1,1,2-Trichloroethane	--	940	ND	3 J
Inorganics:				
Aluminum	--	87	6,930	2,860
Arsenic	50	190	9.3	ND
Barium	1000	--	75.5	41.7
Calcium	--	--	60,100	44,500
Chromium	50 ⁽³⁾	11 ⁽³⁾	13.3	ND
Copper	7	6.54	24.0	11.1
Iron	1,000	1,000	24,500	8,780
Lead	25	132	44.1	17.7
Magnesium	--	--	11,000	7,870
Manganese	50	--	104	84.6
Nickel	25	87.71	9.6	ND
Potassium	--	--	3,350	2,690
Sodium	--	--	85,600	60,100
Vanadium	--	--	34.1	10.1
Zinc	50	58.91	153	83.0

Notes:

Concentrations reported in milligrams per liter (mg/L); or parts per billions (ppb).

ND - Not detected.

J - Estimated value, reported value may not be accurate or precise.

(--)- Standard or criteria not available.

⁽¹⁾ North Carolina Surface Water Regulations for freshwater aquatic life is more stringent standard to support additional uses (NCAC, 1991).

⁽²⁾ FWSV - Freshwater Water Quality Screening Value (USEPA Region IV, 1993)

⁽³⁾ State standard is for total chromium, AWQC and FWSV for the Chromium VI.

Source: Baker Environmental, Inc., Site Inspection Report, 1991.

TABLE 1-12

SEDIMENT SAMPLE ANALYTICAL RESULTS
 SITE INSPECTION
 SITE 44, JONES STREET DUMP
 REMEDIAL INVESTIGATION, CTO-0303
 MCAS, NEW RIVER, NORTH CAROLINA

Sample Number	NOAA SSV ⁽¹⁾		44-SD01	44-SD02
	Parameter: Units	ER-L ⁽²⁾		
Semivolatiles (µg/kg):				
4-Methylphenol	--	--	140 J	ND
Benzoic Acid	--	--	1,800 J	1,000 J
2-Methylnaphthalene	0.065	0.67	110 J	ND
Di-n-butylphthalate	--	--	140 J	170 J
Butyl Benzyl Phthalate	--	--	ND	280 J
bis(2-Ethylhexyl)phthalate	--	--	220 J	290 J
Pesticides/PCBs (µg/kg):				
4,4'-DDE	0.002	0.015	1,000 J	660 J
4,4'-DDD	0.002	0.02	1,000 J	250 J
Inorganics (mg/kg):				
Aluminum	--	--	15,700 J	10,900 J
Arsenic	33	85	5.3 J	ND
Barium	--	--	51.7 J	38.6 J
Calcium	--	--	9,600 J	10,700 J
Chromium	80	145	26.7 J	23.5 J
Copper	70	390	79.5 J	79.1 J
Iron	--	--	11,300 J	10,200 J
Lead	35	110	143 J	144 J
Magnesium	--	--	1,410 J	1,880 J
Manganese	--	--	37.5 J	78.8 J
Nickel	30	50	28.9 J	26.9 J
Potassium	--	--	799 J	ND
Sodium	--	--	ND	ND
Vanadium	--	--	49.4 J	42.8 J
Zinc	120	270	168 J	149 J

TABLE 1-12 (Continued)

SEDIMENT SAMPLE ANALYTICAL RESULTS
SITE INSPECTION
SITE 44, JONES STREET DUMP
REMEDIAL INVESTIGATION, CTO-0303
MCAS, NEW RIVER, NORTH CAROLINA

Notes:

Organic concentrations reported in micrograms per kilogram ($\mu\text{g}/\text{kg}$); or parts per billion (ppb).
Inorganic concentrations reported in milligrams per kilogram (mg/kg); or parts per million (ppm).

J - Estimated value, reported value may not be accurate or precise.

ND - Not Detected

(--)- Standard or criteria not available.

(1) NOAA SSV - National Oceanic and Atmospheric Administration Sediment Screening Values
(USEPA Region IV, 1992)

(2) ER-L - Effects range - low, if contaminant concentrations fall below the ER-L adverse aquatic
effects are considered unlikely.

(3) ER-M - Effects range - median, if contaminant concentrations fall above the ER-M adverse aquatic
effects are considered probable.

If the value falls between ER-L and ER-M adverse aquatic effects are considered possible.

Source: Baker Environmental, Inc. Site Inspection Report, 1991.

TABLE 1-13

**REMEDIAL INVESTIGATION OBJECTIVES
SITE 44, JONES STREET DUMP
REMEDIAL INVESTIGATION CTO-0303
MARINE CORPS BASE, CAMP LEJEUNE, NORTH CAROLINA**

Medium or Area of Concern	RI/FS Objective	Criteria for Meeting Objective	Proposed Investigation/Study
1. Soil	1a. Assess the extent of soil contamination within the suspected disposal area.	Characterize contaminant levels in surface and subsurface soils at Site 44.	Soil Investigation
	1b. Assess human health and ecological risks associated with exposure to surface soils at the site.	Characterize contaminant levels in surface soils at the study area.	Soil Investigation Risk Assessment
	1c. Determine the physical and chemical nature of buried debris and/or waste.	Characterize the physical and chemical nature of buried debris and/or waste.	Test Pit Investigation
2. Groundwater	2a. Determine whether contamination from soils is migrating to groundwater.	Characterize groundwater quality at Site 44.	Groundwater Investigation
	2b. Assess health risks posed by potential future usage of the shallow and deep groundwater.	Evaluate groundwater quality and compare to groundwater criteria and risk-based action levels.	Groundwater Investigation Risk Assessment
	2c. Assess nature and extent of shallow and deep groundwater contamination.	Characterize shallow and deep groundwater quality.	Groundwater Investigation
	2d. Define hydrogeologic characteristics for fate and transport evaluation and remedial technology evaluation, if required.	Estimate hydrogeologic characteristics of the shallow and deep aquifers (flow direction, transmissivity, permeability, etc.).	Groundwater Investigation

TABLE 1-13 (Continued)

**REMEDIAL INVESTIGATION OBJECTIVES
SITE 44, JONES STREET DUMP
REMEDIAL INVESTIGATION CTO-0303
MARINE CORPS BASE, CAMP LEJEUNE, NORTH CAROLINA**

Medium or Area of Concern	RI/FS Objective	Criteria for Meeting Objective	Proposed Investigation/Study
3. Surface Water	3a. Assess the presence or absence of surface water contamination in Edwards Creek, and an unnamed tributary.	Determine surface water quality in Edwards Creek, and an unnamed tributary.	Surface Water Investigation
	3b. Assess potential ecological impacts posed by contaminated surface water in Edwards Creek, and an unnamed tributary.	Determine surface water quality in Edwards Creek, and an unnamed tributary.	Surface Water Investigation Evaluation of Bioassay Results
4. Sediment	4a. Assess human health and ecological risks associated with exposure to sediments in Edwards Creek, and an unnamed tributary.	Characterize nature and extent of contamination in sediment.	Sediment Investigation Risk Assessment
	4b. Assess potential ecological impacts posed by contaminated sediments in Edwards Creek, and an unnamed tributary.	Qualitatively evaluate stress to benthic and fish communities.	Sediment Investigation Evaluation of Bioassay Results
	4c. Determine extent of sediment contamination for purposes of identifying areas of concern.	Identify extent of sediment contamination where contaminant levels exceed risk-based action levels or USEPA Region IV criteria.	Sediment Investigation Risk Assessment

SECTION 1.0 FIGURES

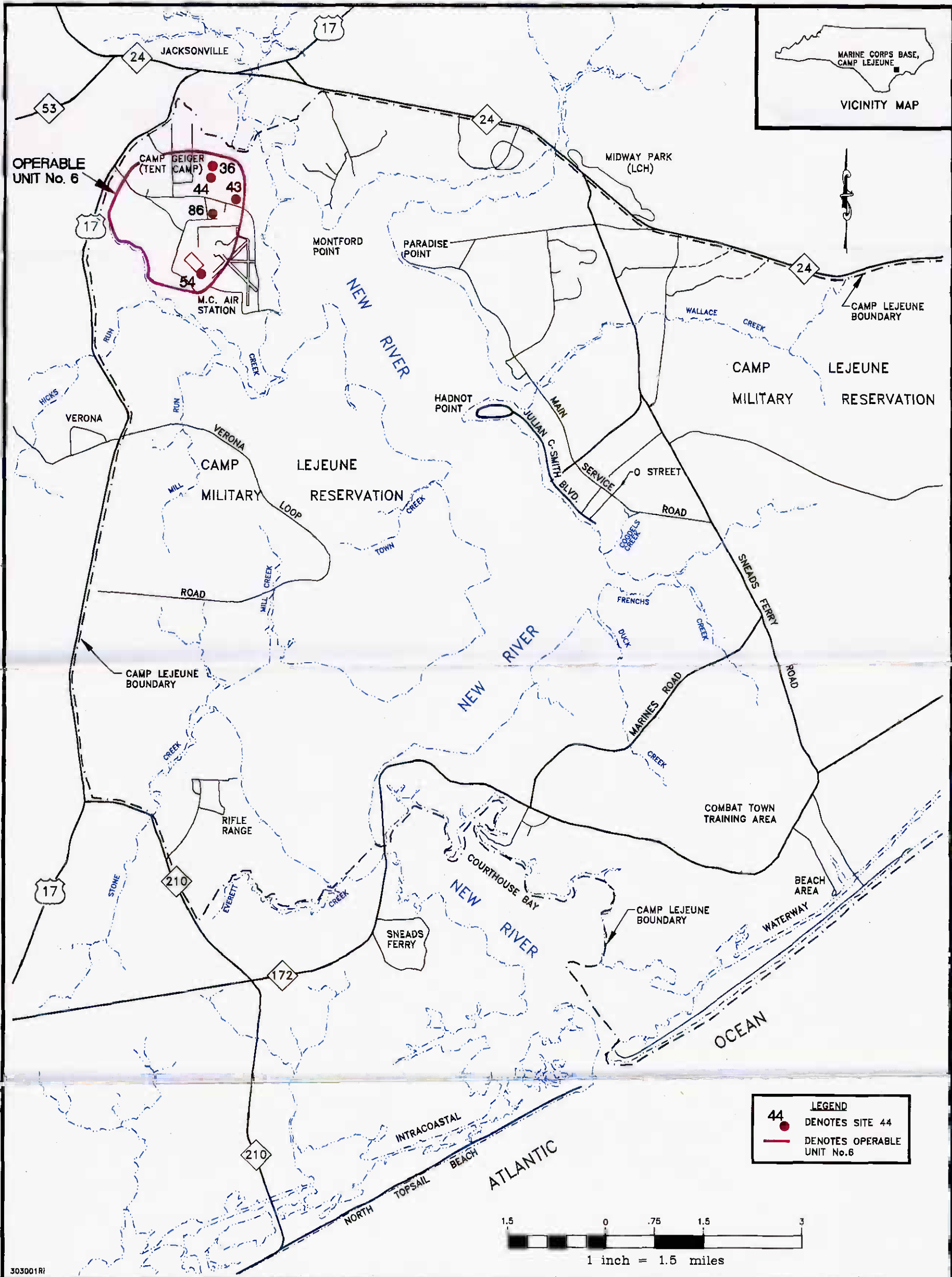

FIGURE 1-1
 OPERABLE UNIT No. 6 - SITES 36, 43, 44, 54, AND 86
 REMEDIAL INVESTIGATION, CTO-0303

MARINE CORPS AIR STATION, NEW RIVER
 NORTH CAROLINA

01715VRIV

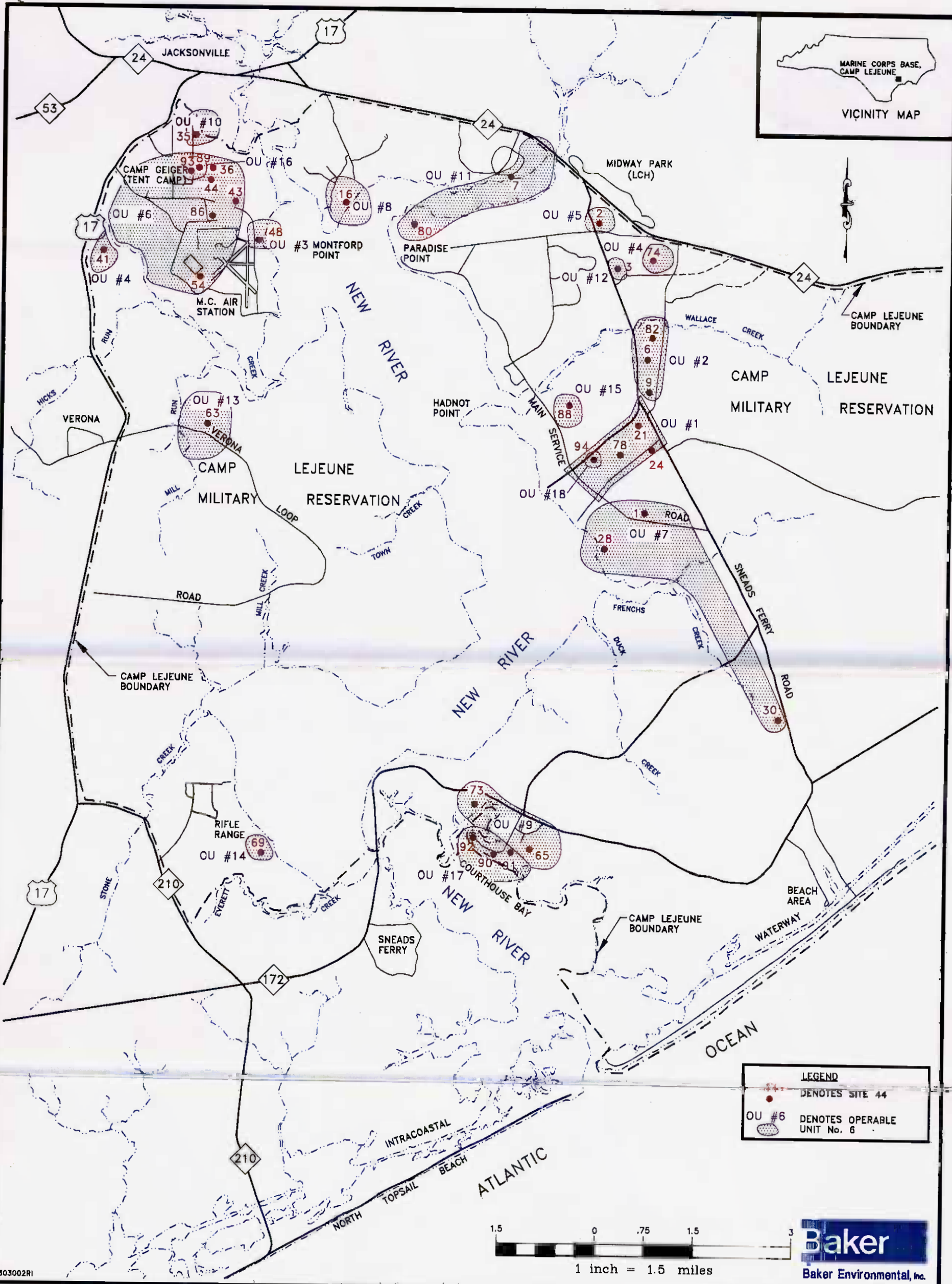

FIGURE 1-2
OPERABLE UNIT AND SITE LOCATIONS
REMEDIAL INVESTIGATION, CTO-0303

MARINE CORPS BASE, CAMP LEJEUNE
NORTH CAROLINA

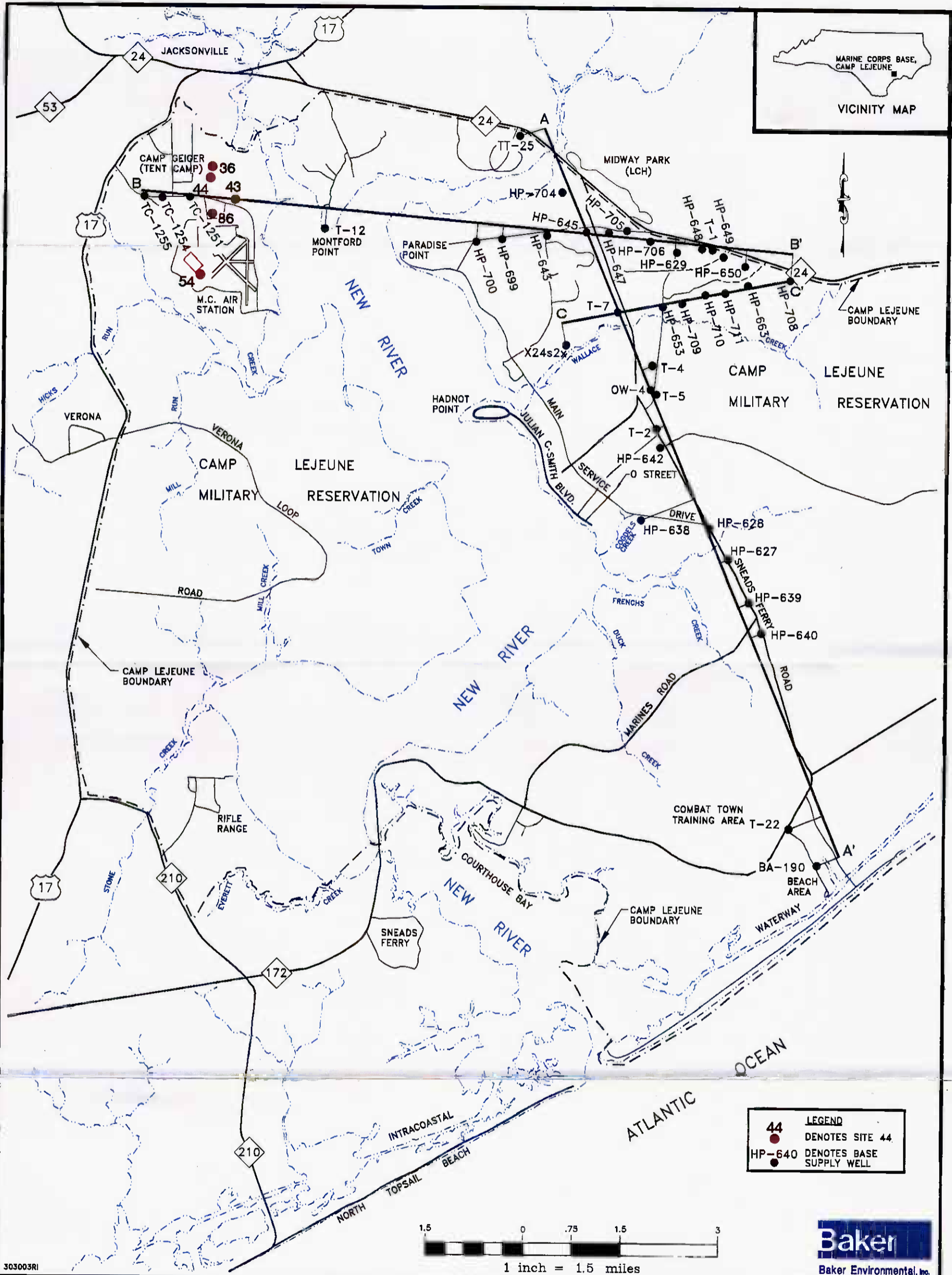

FIGURE 1-3
 LOCATIONS OF HYDROGEOLOGIC CROSS-SECTIONS
 REMEDIAL INVESTIGATION, CTO-0303

MARINE CORPS AIR STATION, NEW RIVER
 NORTH CAROLINA

SOURCE: DEPT. OF INTERIOR,
 WATER-RESOURCES INVESTIGATIONS
 REPORT, 89-4096, PLATE 4

303003RI

Baker
 Baker Environmental, Inc.

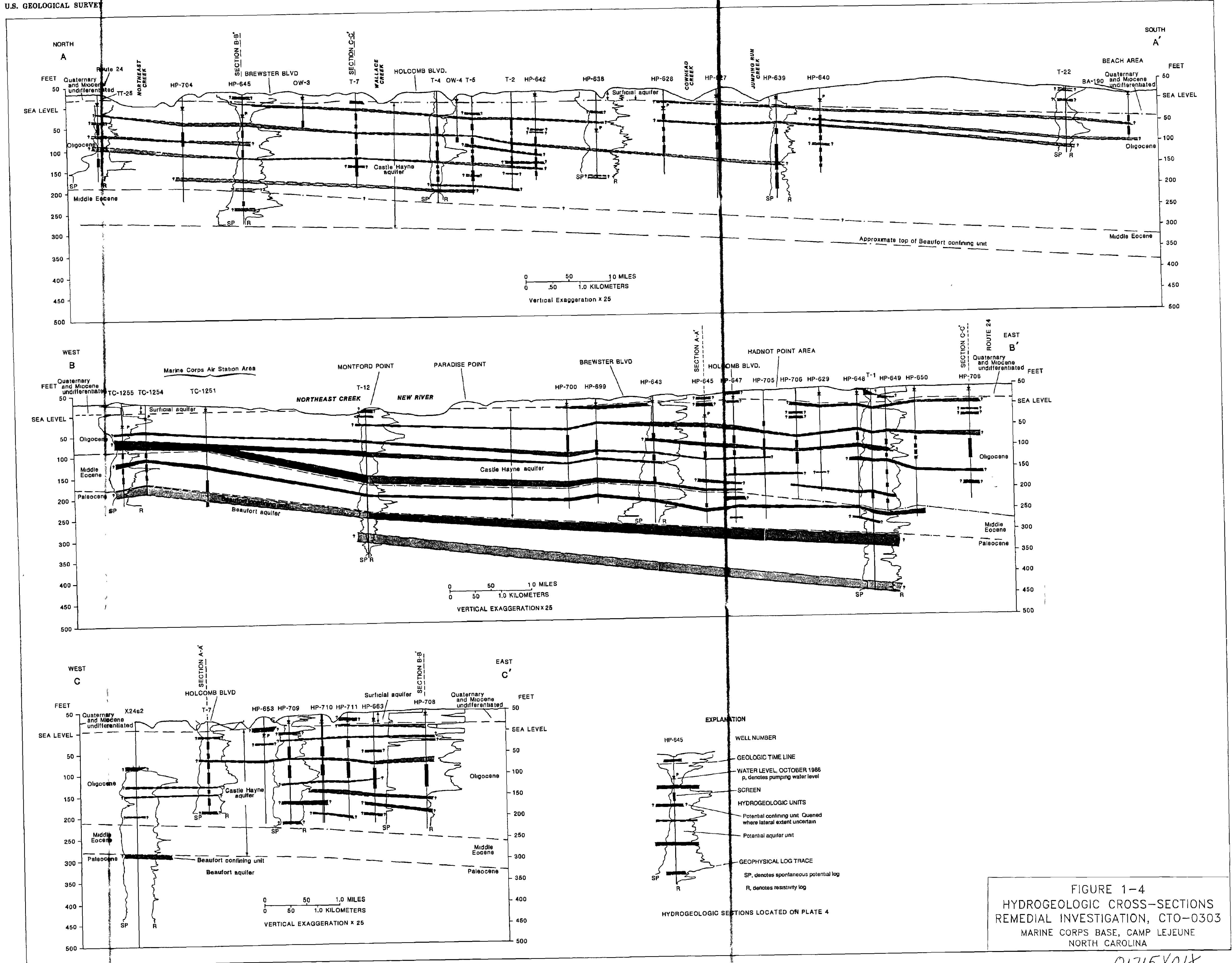
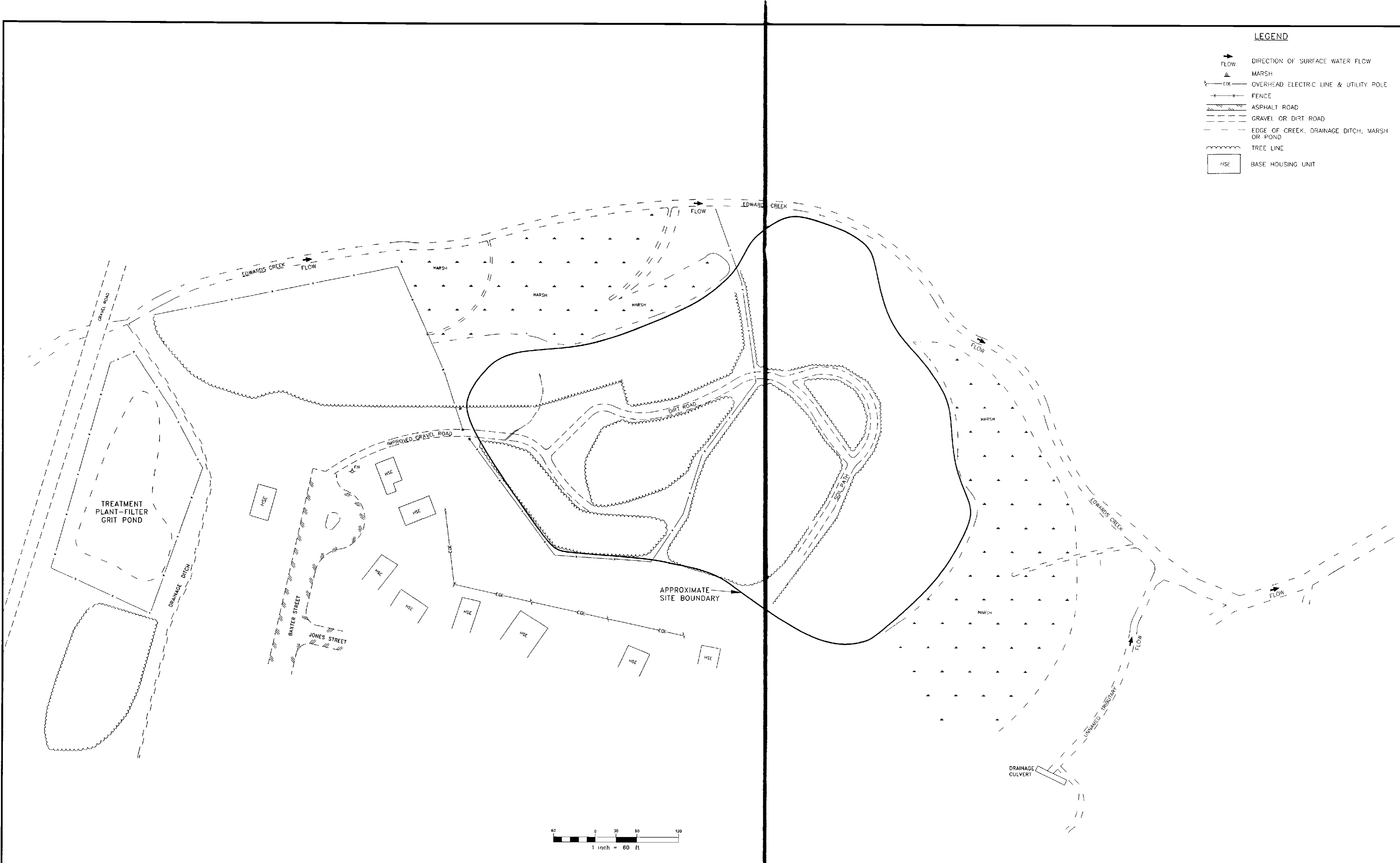

FIGURE 1-4
HYDROGEOLOGIC CROSS-SECTIONS
REMEDIAL INVESTIGATION, CTO-0303
MARINE CORPS BASE, CAMP LEJEUNE
NORTH CAROLINA

01715401X

LEGEND

- FLOW DIRECTION OF SURFACE WATER FLOW
- ▲ MARSH
- |—|— OVERHEAD ELECTRIC LINE & UTILITY POLE
- x—x— FENCE
- /—/— ASPHALT ROAD
- - - - - GRAVEL OR DIRT ROAD
- - - - - EDGE OF CREEK, DRAINAGE DITCH, MARSH OR POND
- ~ ~ ~ ~ ~ TREE LINE
- [] HSE BASE HOUSING UNIT



<p>REVISIONS</p>	<p>DRAWN REL REVIEWED TFT/JEZ S O # 62470-303 CADD# 303006RI</p>	<p>NORTH</p>	<p>REMEDIATION INVESTIGATION CTO-0303 MARINE CORPS AIR STATION NEW RIVER NORTH CAROLINA</p>	<p>Baker Environmental, Inc.</p>	<p>SITE MAP SITE 44, JONES STREET DUMP</p>	<p>FIGURE No. 1-5</p>
<p>SOURCE LANTDIV, FEBRUARY 1992 SURVEY BRENT A LANIER AND ASSOCIATES, 1995</p>		<p>1 inch = 60 ft</p>		<p>SCALE 1" = 60'</p>	<p>DATE JANUARY 1996</p>	

01715Y02X

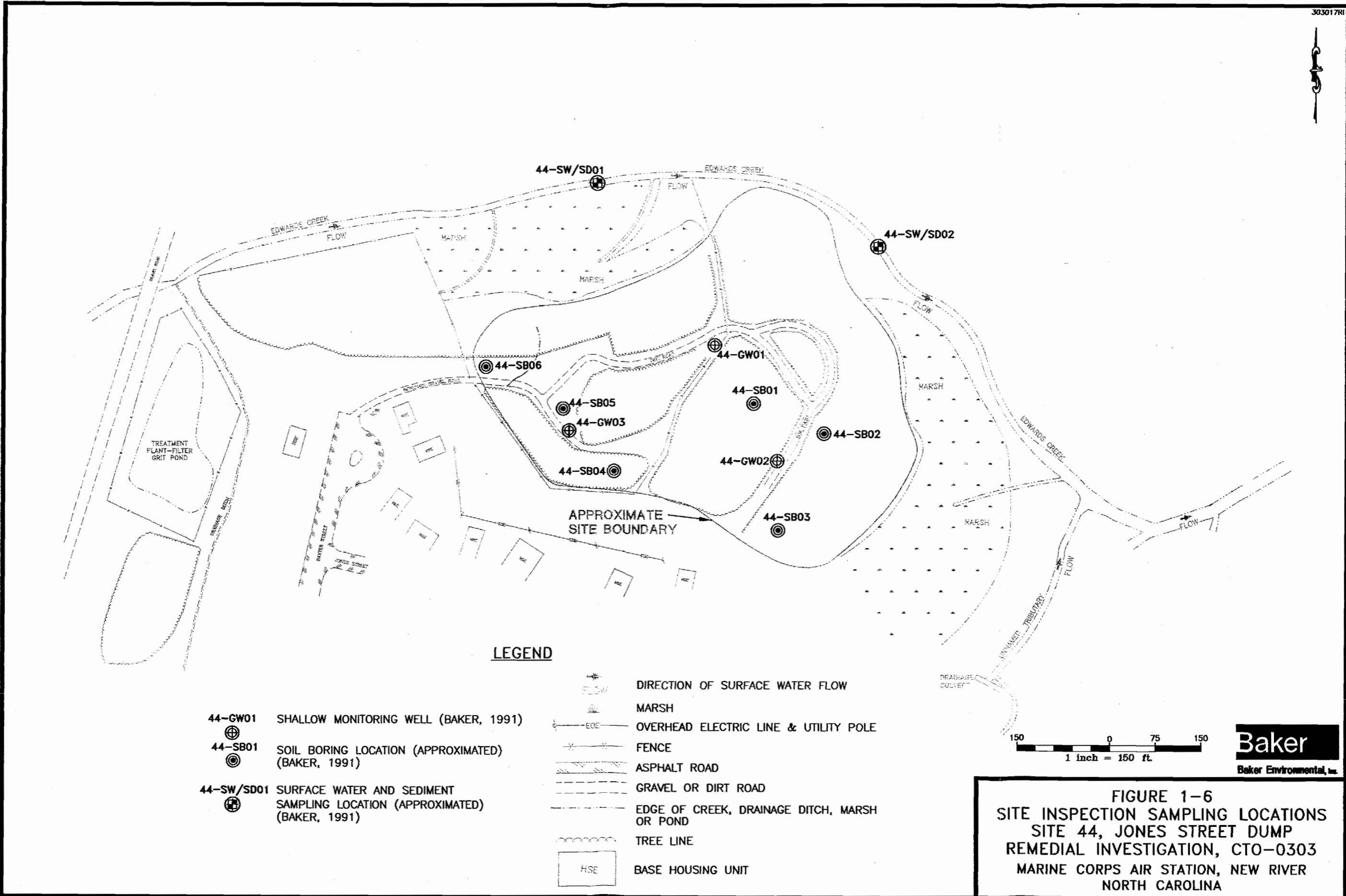

LEGEND

- 44-GW01 SHALLOW MONITORING WELL (BAKER, 1991)
- 44-SB01 SOIL BORING LOCATION (APPROXIMATED) (BAKER, 1991)
- 44-SW/SD01 SURFACE WATER AND SEDIMENT SAMPLING LOCATION (APPROXIMATED) (BAKER, 1991)

- DIRECTION OF SURFACE WATER FLOW
- MARSH
- OVERHEAD ELECTRIC LINE & UTILITY POLE
- FENCE
- ASPHALT ROAD
- GRAVEL OR DIRT ROAD
- EDGE OF CREEK, DRAINAGE DITCH, MARSH OR POND
- TREE LINE
- BASE HOUSING UNIT

150 0 75 150
1 inch = 150 ft.



FIGURE 1-6
SITE INSPECTION SAMPLING LOCATIONS
SITE 44, JONES STREET DUMP
REMEDIAL INVESTIGATION, CTO-0303
MARINE CORPS AIR STATION, NEW RIVER
NORTH CAROLINA

01715Y032

2.0 SITE CHARACTERISTICS

Section 2.0 of this report presents information on site-specific physical characteristics. This section includes a discussion on the topography, surface water hydrology and drainage features, geology, hydrogeology, ecology.

2.1 Topography and Surface Features

Site 44 contains a mixture of woods and fields. General surface topography is presented on Figure 2-1. The site slopes gently from the site entrance (at Baxter Street) to the east, or toward an unnamed tributary to Edwards Creek. A steep slope is present along the northern portion of the site. A flat marsh area is present between the foot of the slope and Edwards Creek. The top of the slope is approximately 12 feet above the marsh area. The elevation of the site ranges from a low of approximately 3 feet above mean sea level (msl) near the unnamed tributary, to greater than 15 feet above msl in the vicinity of the site entrance.

2.2 Surface Water Hydrology

Surface water movement is limited at Site 44 due to heavy vegetation, and woodlands. Surface runoff could potentially flow in primary two directions. Runoff could flow north over the steep slope to the marsh area. Runoff could also flow to the east, toward the marsh area adjacent to the unnamed tributary. At the time of the investigation, ponded water and saturated soils were observed in the lower elevations of the site and in the marshy areas bordering the site. Soil in the vicinity of 44-GW03 were observed to be saturated.

2.3 Soil

According to the Soil Conservation Service (SCS) Soil Survey of Camp Lejeune, North Carolina (1984), Site 44 is underlain primarily by the Baymeade (BaB) urban land complex. A second unit, the Muckalee (Mk) soil complex, bounds the site on the north. The Baymeade complex is typically found in areas where the original soil has been cut, filled, or graded. Soil properties of this unit have been altered through slope modification and smoothing. Generally, Baymeade soils are moderately to strongly acidic and are classified under the SCS as fine sand (SM-SP) and loamy fine sand (SM). The Muckalee complex soils tend to be poorly drained and found on flood plains. The Muckalee is frequently flooded for brief periods and is subject to ponding. Muckalee soils are classified by the SCS as loam (ML). Table 2-1 provides a summary of soil physical properties found at Site 44.

2.4 Geology

A depositional sequence was observed in the deep well borings at Site 44 that matches the sequence discussed in the U.S. Geological Survey's hydrogeologic assessment of Camp Lejeune (Cardinell, et al., 1993). The uppermost formation at Site 44 is the undifferentiated formation. The Belgrade Formation lies below, with the River Bend Formation below that.

The undifferentiated formation, typically consists of three units of Holocene and Pleistocene ages. The upper unit is 3 to 8 feet thick and predominantly consists of silt and clay layers that are medium stiff to very stiff. The middle unit is predominantly a fine sand with lesser amounts of silt and clay, and is loose to medium dense. This unit is approximately 12 to 14 feet thick. The lower unit is generally a fine to medium sand and shell fragments with lesser amounts of silt, or a clayey silt and

shell fragments. These sediments are typically medium dense to very dense, and are approximately 30 feet thick. The undifferentiated formation typically extends to a depth between 45 and 50 feet bgs.

The Belgrade Formation, is predominantly a fine sand and clayey silt of the Miocene age. The top of this Formation lies 45 to 50 feet bgs, is approximately 5 feet thick, and has a distinct green or greenish-gray color. These sediments are typically medium dense to dense.

The River Bend Formation is predominantly a fine to medium sand with lesser amounts of silt and clay of the Oligocene age. This Formation lies 52 to 57 feet bgs at Site 44. The sediments of this formation are typically medium dense to dense.

Geologic cross-sections depicting the shallow and deep sediment lithologies were developed based on soils collected during the RI. Soil boring logs are presented in Appendix A, well construction logs in Appendix B, and test pit records in Appendix C. Figure 2-1 shows locations of the cross-sections traversing Site 44 and Figure 2-2 depicts lithologies. Most wells and borings at Site 44 are shallow. Cross-sections A-A', B-B', C-C', and D-D' depict only the upper portion of the undifferentiated formation.

Section A-A' traverses west to east across Site 44. This section shows fine-grained soils present at the surface. Clay is present up to a depth of 8 feet bgs. A silty fine sand to medium to coarse sand lies below the clay. Groundwater generally occurs below the clay.

Section B-B' traverses west to east across Site 44. This section shows that silt is present at the surface on the western end of the section and clay on the eastern end. A silty fine sand is present beneath the silt and clay, with fine to medium sand at the western end of the section. Groundwater generally occurs below the silt and clay.

Section C-C' traverses north to south across Site 44. Clay is present at the surface along the middle of the section. The clay is only 1 foot thick, however. An 8 foot thick bowl-shaped fine sand and silty clay is present below the clay. This layer was observed to contain a small amount of debris, including rock fragments and wood. A silty fine sand to fine sand is predominant in the subsurface surrounding the debris-containing layer.

Cross-section D-D' traverses north to south across Site 44. Clay is present at the surface along the middle of the section. Silt is present at the surface at the northern and southern ends of the section. A fine to coarse sand is present below the silt and clay along the northern end of the section. A silty sand is present below the silt and clay along the southern end of the section. Groundwater generally occurs below the silt and clay.

Cross-section E-E' traverses southwest to northeast across the site 44. This section extends into the River Bend Formation and typifies the general description discussed at the beginning of the Section. This section shows an upper unit consisting of silt and clay layers. The second unit is generally a fine sand, however the sediments become finer with depth. The third unit consists of sand and shell fragments. The upper portion of this unit tends to consist of clayey silt rather than sand. The sediments of the Belgrade Formation were observed to be damp and approximately 5 feet thick. Groundwater occurs with the middle unit of the upper undifferentiated formation (fine sand), and then again in the River Bend Formation.

2.5 Hydrogeology

There are several aquifers beneath Site 44 and vicinity. The upper two aquifers were investigated in this study, namely the surficial and Castle Hayne aquifers. The surficial aquifer occurs within the sediments of the undifferentiated formation. The surficial aquifer, which is unconfined (i.e., water table aquifer), typically lies within 10 feet of the surface, and is approximately 43 feet thick in the vicinity of Site 44. The upper portion of the Castle Hayne aquifer lies within the sediments of the River Bend Formation. The Castle Hayne aquifer lies 52 to 57 feet bgs, and is approximately 200 feet thick in the vicinity of Camp Gieger and the Air Station (Cardinell et al., 1993). The Belgrade Formation, situated between the Undifferentiated and River Bend Formations is also known as the Castle Hayne confining unit. The Castle Hayne confining unit is approximately 5 feet thick in the vicinity of Site 44.

The hydrogeologic conditions were evaluated by installing a network of shallow and deep monitoring wells. Four staff gauges were located in Edwards Creek and an unnamed tributary to monitor surface water elevation.

2.5.1 Groundwater Elevation Data

Groundwater and surface water elevation data for Site 44 are summarized on Table 2-2. Three rounds of groundwater level measurements were collected in March, April, and May of 1995. One round of water level data is available for the staff gauges because of the installation timing.

The groundwater elevation data from all wells exhibit a downward trend between March and May (Figure 2-3A and B). The decrease in elevation ranged from approximately 1.2 to 2.1 feet. This data trend is attributable to the lack of rain during the time period.

Groundwater in the Castle Hayne aquifer exhibits an upward component to flow. An examination of the elevation differences between the shallow and deep wells (Figure 2-3B) shows that the Castle Hayne aquifer groundwater elevations are consistently higher than those of the surficial aquifer.

2.5.2 Groundwater Flow Contour Maps

Surficial groundwater elevation contour maps were developed from static water level data collected between March and May of 1995. Excluding May 1995 staff gauge data, the surficial groundwater flow direction and gradient were consistent between March and May. Greater areal coverage is provided with the inclusion of the staff gauge data in May. A surficial aquifer groundwater contour map is presented as Figure 2-4 using May 1995 data.

Castle Hayne groundwater elevation contour maps were developed from static water level data collected between March and May of 1995. Data from Site 44 and 43 were compiled because only two deep well were installed at each site. Groundwater flow patterns were consistent between March and May. A Castle Hayne groundwater contour map is presented as Figure 2-5 using May 1995 data.

Flow gradients were determined by dividing a certain distance of a flow line (or distance between two wells) into the change in groundwater elevation over that distance (Appendix O). Flow gradients may vary slightly from month to month due to changes in groundwater elevations.

Shallow groundwater flow across Site 44 is semi-radial, following topography. A surficial groundwater divide is evident between wells 44-GW03 and 44-GW06. This divide is coincident with a topographic high in that vicinity. The groundwater flow gradient is fairly consistent across the site; approximately 0.006 to 0.007 feet/foot.

Groundwater flow in the upper portion of the Castle Hayne aquifer is to the east between Site 43 and 44. The flow gradient is approximately 0.001 feet/foot to 0.002 feet/foot, toward the New River.

2.5.3 Hydraulic Properties

Rising and falling head slug tests were conducted at Site 44 on several shallow and deep monitoring wells. The slug test data were analyzed using the Bower-Rice method on AQTESOLV Version 2.0 software. The solutions are presented in Appendix N and summarized on Table 2-3.

Rising head test data is used in the text discussions. Falling head test data were evaluated as a check against the rising head test for the deep monitoring wells only. The falling head test data were not valid for the shallow wells because the static water level wells were within the screened interval.

The sediments of the surficial aquifer tend to be fine grained. These sediments exhibit hydraulic conductivity values on the order of 0.4 to 2.0 feet/day, typical for such fine grained sediments. The hydraulic conductivity values varied due to the varying composition of the surficial aquifer.

Hydraulic conductivity values in the Castle Hayne are consistent, 17.5 and 18.1 feet/day. Generally, sediments in the Castle Hayne are coarser than those of the surficial aquifer. The average hydraulic conductivity is an order of magnitude higher in the Castle Hayne aquifer than in the surficial aquifer.

Transmissivity is the hydraulic conductivity multiplied by the saturated thickness of the aquifer. The calculated transmissivity of the Castle Hayne aquifer is nearly two orders of magnitude higher than the surficial aquifer. This is because the thickness of the Castle Hayne is 200 feet compared to a 35 foot saturated thickness of the surficial aquifer. Also, the average hydraulic conductivity of the Castle Hayne is higher than in the surficial aquifer.

The surficial aquifer hydraulic conductivity values are an order of magnitude lower than the value presented in the Cardinell's report. The average hydraulic conductivity at Site 44, based on RI slug tests is 1.4 feet/day, compared to 50 feet/day presented by Cardinell. The Cardinell value was based on a general composition of fine sand, mixed with some silt and clay. The surficial aquifer at Site 44 may contain more fine-grained sediments than accounted for by Cardinell's estimate assumptions. The average hydraulic conductivity and transmissivity for the Castle Hayne at Site 44 is 17.8 feet/day and 3,560 feet²/day, respectively. Cardinell's report presents hydraulic conductivities and transmissivities from several studies. Hydraulic conductivities range from 14 to 91 feet/day and transmissivities range from 820 to 26,000 feet²/day. The RI results for Site 44 are comparable with other sites throughout Camp Lejeune.

Geotechnical analyses, including particle size analysis and vertical hydraulic conductivity was performed on a sample collected via a shelby tube from the Castle Hayne confining unit (Appendix L). The sample was taken from 54 to 54.7 feet bgs at well boring 44-GW01DW. This sample was determined to be a silty fine to medium sand with a vertical permeability of 1.3×10^{-5} cm/sec, or 0.04 feet/day.

2.5.4 Groundwater Flow Velocities

Groundwater flow velocities can be estimated using a variation of Darcy's equations:

$$V = Ki/n_e$$

where; V = groundwater velocity (feet/day)
 K = Hydraulic conductivity (feet/day)
 i = horizontal gradient (feet/foot)
 n_e = effective porosity

"K" values were determined from slug tests conducted at wells 44-GW04, 44-GW05, 44-GW06, 44-GW01DW, and 44-GW06DW. Surficial aquifer hydraulic conductivity values ranged from 0.4 feet/day at 44-GW05 to 2.0 feet/day at 44-GW04. Castle Hayne aquifer hydraulic conductivity values were 17.5 feet/day at 44-GW06DW and 18.1 feet/day at 44-GW01DW. Flow gradient values were determined by using groundwater contours (Section 2.5.3). An effective porosity value of 30% was used (Fetter, 1988), based on the silty sands underlying the site. Velocity calculations are presented in Appendix O. Velocities may vary slightly from month to month due to changing gradients.

The calculated groundwater flow velocities of the surficial aquifer varied slightly across the site. The velocity values ranged from 0.01 at 44-GW05 to 0.05 at 44-GW04. The variations in groundwater flow velocities across the site are likely due to the heterogeneous soil conditions at the site. These heterogeneties cause the hydraulic properties to change spacially.

The calculated groundwater flow velocities for the Castle Hayne were 0.36 feet/day at 44-GW01DW and 0.35 feet/day at 44-GW06DW. The higher velocities of the Castle Hayne aquifer as compared to the surficial aquifer are attributable to higher hydraulic conductivity values of the Castle Hayne.

2.5.5 General Groundwater Flow Patterns

Groundwater flow in the surficial aquifer at Site 44 is toward Edwards Creek and the unnamed tributary, with an average velocity of 0.03 feet per day. Based on groundwater flow direction and groundwater elevation relative to surface water elevations, the surficial aquifer discharges to Edwards Creek and the unnamed tributary.

Groundwater flow in the upper Castle Hayne aquifer is east under the site with an average velocity of 0.36 feet/day. Groundwater elevation data compiled and mapped by Cardinell indicate that groundwater in the Castle Hayne aquifer flows toward and discharges to the New River and its major tributaries, including the air station vicinity.

The Castle Hayne confining unit appears to be semi-confining. The groundwater elevations in the deep and shallow wells respond similarly to precipitation and/or atmospheric changes. The confining unit is relatively thin, approximately 5 feet thick, with a measured vertical permeability of 0.04 feet/day. Based on groundwater elevations in shallow and deep well clusters, there appears to be a consistent upward groundwater flow from the Castle Hayne to the surficial aquifer.

2.6 Identification of Water Supply Wells

Potable water supply wells within a one-mile radius of the site were identified by reviewing the Wellhead Management Program Engineering Study (Geophex, Ltd., 1991) document. Eleven water supply wells were identified within the one-mile radius. Six of the eleven wells were reported to be operating. Table 2-4 summarizes some well construction details and Figure 2-6 shows the location of the supply wells. These supply wells are located upgradient of Site 44 based on their location with respect to easterly groundwater flow direction in the Castle Hayne. Additionally, well supply wells do not seem to affect natural flow conditions at Site 44.

Eight of the eleven supply wells were sampled in 1992 (Greenhorne & O'Mara, 1992). Detected compounds are presented on Table 2-4. No organic compounds were detected in any of the wells listed. Several inorganic analytes were detected. The USEPA has established secondary maximum concentration limits (SMCLs) for several of the analytes. North Carolina has also established standards for several of the analytes. The Aluminum SMCL was exceeded in seven of eight wells sampled. Aluminum was not detected in MCAS-131. Iron exceeded the SMCL/Standard in six of eight wells, manganese was exceeded in three wells, and TDS was exceeded five wells.

The inorganics detected in the groundwater samples appear to be ubiquitous at Camp Lejeune. Aluminum, iron, and manganese have been detected in monitoring wells at Site 44 and other OU 6 sites, as well as other supply wells.

2.7 Ecology

Two types of wetlands are present at Site 44. The primary type of wetland is palustrine, forested, broad-leaved deciduous, partially drained wetland. It is present along Edwards Creek and the unnamed tributary to Edwards Creek. The treatment plant filter grit pond is classified as a palustrine, unconsolidated bottom, permanently flooded, diked wetland.

Apart from the wetlands, no sensitive environments were identified at site 44 studied during this remedial investigation. No endangered species were noted during the habitat evaluation nor were endangered species referenced at any of the sites during the endangered species survey (LeBlond, 1994).

Four different habitat types were identified at Site 44 during the habitat evaluation. These include a mixed forest over much of the site area, an upland forest in areas of higher elevation, a swamp along the creek and creek tributaries, and an open area on top of the former disposal area. Figure 2-7 shows a biohabitat map for the Site 44 area.

The mixed forest is dominated by loblolly pine (*Pinus taeda*) mixed with water oak (*Quercus nigra*) and sweetgum (*Liquidambar styraciflua*). A variety of shrubs, none of which is dominant, is present in the understory. Shrubs identified include privet (*Ligustrum vulgare*), juniper (*Juniperus virginianus*), blueberry (*Vaccinium* sp.), redbay (*Persea borbonia*), and olive (*Elaeagnus pungens*). Japanese honeysuckle (*Lonicera Sponica*) and greenbriar (*Smilax rotundifolia*) are also found in the understory. Seedlings of Japanese honeysuckle are dominant in many areas of the forest floor, while other areas are sparsely vegetated. Two species, heartleaf (*Hexastylis arifolia*) and geum (*Geum* sp.) were identified during the habitat evaluation.

The mixed forest grades to upland forest in the higher areas farther from the site. Four tree species, none of which is dominant, are present in the upland forest. These include white oak (Quercus alba), tulip poplar (Liriodendron tulipifera), black cherry (Prunus serotina), and sweetgum (Liquidambar styraciflua). Dogwood (Cornus florida) and holly (Ilex opaca) make up the understory. No vines are present. Plants present on the forest floor are typical of upland deciduous forests and include crane fly orchid (Tipularia discolor), heartleaf (Hexastylis arifolia), christmas fern (Aspidium acrostichoides), and partridgeberry (Mitchella repens).

A swamp or wooded wetland can be found along the creeks and the creek tributaries. The trees in this swamp include a mix of red maple (Acer rubrum), swamp chestnut oak (Quercus michauxii), ironwood (Carpinus caroliniana), and sourgum (Oxydendrum arboreum). The understory is made up of a variety of shrubs including rosebay (Magnolia virginiana), redbay (Persea borbonia), privet (Ligustrum vulgare), and fetterbush (Lyonia lucida). Wetland vegetation is present on the floor of the swamp and includes the following species:

- Sensitive Fern- Onoclea sensibilis
- Switch Cane- Arundinaria tecta
- Mayapple- Podophyllum peltatum
- Arrow Arum- Peltandra virginica
- Jewelweed- Impatiens capensis
- Hydrocotyl- Hydrocotyl americana
- Southern Shield Fern- Dryopteris ludoviciana
- Blue Violet- Viola papilionacea
- Watercress- Nasturtium officinale
- Water Smartweed- Polygonum amphibium

A small open area is present at the end of the access road to the site. Portions of this open area are covered with stands of young loblolly pines (Pinus taeda). Three vines, Japanese honeysuckle (Lonicera japonica), dewberry (Rubus hispida), and jasmine (Gelsemium sempervirens) are growing among the pines and along the ground. The area that is not covered by young pines is dominated by grasses including bushy beardgrass (Andropogon glomeratus). The following forbs are intermixed with the grasses:

- White Clover- Trifolium repens
- Vetch- Vicia sp.
- Dandelion- Taraxacum officinale
- Creeping Buttercup- Ranunculus repens
- Peppergrass- Lepidium virginicum
- Narrow-leaved Plantain- Plantago lanceolata
- Curly Dock- Rumex crispus
- Ebony Spleenwort- Asplenium platyneuron

Because of the variety of habitat, a number of birds were observed during the habitat evaluation. Both resident and migratory birds were identified including the following:

- Robin- Turdus migratorius
- Cardinal- Richmondia cardinalis
- Carolina Chickadee- Parus carolinensis
- Fish Crow- Corvus ossifragus

- Carolina Wren- Thryothorus ludovicianus
- Yellow Warbler- Dendroica petechia
- Blue Jay- Cyanocitta cristata
- Mourning Dove- Zenaida macroura
- Red-bellied Woodpecker- Melanerpes carolinus
- Grackle- Quiscalus quiscula

Although no mammals were observed during the habitat evaluation, mammal sign was noted. Tracks of whitetail deer (Odocoileus virginianus), opossum (Didelphis marsupialis), and raccoon (Procyon lotor) were all found. A buck rub was also observed, as was feeding sign of a squirrel (Sciurus sp.) The only reptile or amphibian observed was a frog, which was not seen at close enough range for identification.

2.8 References

Barnhill, W.L. 1984. Soil Survey of Camp Lejeune, North Carolina. USDA, Soil Conservation Service.

Cardinell, A.P., Berg, S.A., and Lloyd O.B. Jr. 1993. Hydrogeologic Framework of U.S. Marine Corps Base at Camp Lejeune, North Carolina. USGS. Water-Resources Investigations Report 93-4049.

Fetter, C.W. 1986. Applied Hydrogeology. Charles E. Merrill Publishing Co., Columbus, Ohio.

Geophex, Ltd. 1992. Wellhead Management Program Engineering Study 91-36. Prepared for Marine Corps Base, Camp Lejeune, North Carolina. January 22, 1992.

Greenhorne & O'Mara. 1992. Preliminary Draft Report Wellhead Monitoring Study. Prepared for the Department of the Navy, Civil Branch. December, 1992.

Harned, D.A., Lloyd, O.B., Jr., and Treece, M.W., Jr. 1989. Assessment of Hydrologic and Hydrogeologic Data at Camp Lejeune Marine Corps Base, North Carolina. USGS. Water-Resources Investigations Report 89-4096.

LeBlond, Richard. 1991. Critical Species List - Camp Lejeune Endangered Species and Special-Interest Communities Survey. Principal Investigator.

SECTION 2.0 TABLES

TABLE 2-1

SUMMARY OF SOIL PHYSICAL PROPERTIES AT SITE 44
 REMEDIAL INVESTIGATION CTO - 0303
 MCAS, NEW RIVER, NORTH CAROLINA

Soil Name	Soil Symbol	USCS Classification	Depth (inches)	Moist Bulk Density (g/cc)	Permeability (cm/s)	Soil Reaction (pH)	Shrink-Swell Potential	Organic Matter (percent)
Baymeade-Urban	BaB	SM, SP-SM	0 - 30	1.60 - 1.75	4.2×10^{-3} - 1.37×10^{-2}	4.5 - 6.5	Low	0.5 - 1.0
Muckalee	Mk	ML	0 - 28	--	4.2×10^{-4} - 1.37×10^{-3}	5.1 - 7.3	Low	0.5 - 2.0

Source: Soil Survey: Camp Lejeune, North Carolina, U. S. Department of Agriculture - Soil Conservation Service, 1984.

- Notes:
- ML - Loam
 - SM - Loamy Fine Sand
 - SP - Fine Sand
 - - Not Estimated
 - SC - Fine Sandy Loam

TABLE 2-2

SUMMARY OF GROUNDWATER AND SURFACE WATER ELEVATIONS
 SITE 44
 REMEDIAL INVESTIGATION CTO-0303
 MCAS NEW RIVER, NORTH CAROLINA

Well No.	Casing Elevation	Static Water Levels (TOC)			Groundwater Elevations		
		3/26/95	4/10/95	5/6/95	3/26/95	4/10/95	5/6/95
44-GW01	14.68	8.48	9.15	10.17	6.20	5.53	4.51
44-GW02	12.90	6.95	7.63	8.67	5.95	5.27	4.23
44-GW03	17.34	10.45	11.12	11.99	6.89	6.22	5.35
44-GW04	17.55	11.03	11.61	12.50	6.52	5.94	5.05
44-GW05	14.26	8.79	9.28	10.03	5.47	4.98	4.23
44-GW06	13.13	4.66	5.49	6.74	8.47	7.64	6.39
44-GW01DW	13.89	7.58	8.11	9.00	6.31	5.78	4.89
44-GW06DW	13.29	4.71	5.29	6.21	8.58	8.00	7.08
44-SG01	4.08	NA	NA	1.10	NA	NA	1.84
44-SG02	2.91	NA	NA	1.10	NA	NA	0.67
44-SG03	2.57	NA	NA	1.22	NA	NA	0.45
44-SG04	2.82	NA	NA	1.60	NA	NA	1.08

TABLE 2-3

HYDRAULIC PROPERTIES SUMMARY
 SITE 44
 REMEDIAL INVESTIGATION CTO - 0303
 MCAS, NEW RIVER, NORTH CAROLINA

Well ID	Conductivity		Transmissivity		Conductivity		Transmissivity		General Soil Description
	Rising Head (ft/day)	Falling Head (ft/day)	Rising Head (ft ² /day)	Falling Head (ft ² /day)	Rising Head (cm/day)	Falling Head (cm/day)	Rising Head (cm ² /day)	Falling Head (cm ² /day)	
44-GW04	2.0	--	90.0	--	7.06e-04	--	1.0	--	F sand, trace silt w/ silty sand layer
44-GW05	0.4	--	18.0	--	1.41e-04	--	0.2	--	F/M sand & silty sand layers
44-GW06	1.7	--	76.5	--	6.00e-04	--	0.8	--	F sand & silt
MAXIMUM	2.0	--	90.0	--	7.06e-04	--	1.0	--	
MINIMUM	0.4	--	18.0	--	1.41e-04	--	0.2	--	
AVERAGE	1.4	--	61.5	--	4.82e-04	--	0.7	--	
44-GW01DW	18.1	22.5	3,620.0	4,500.0	6.39e-03	7.94e-03	38.9	48.4	F sand, trace med. sand, shell frag., & silt
44-GW06DW	17.5	22.7	3,500.0	4,540.0	6.18e-03	8.01e-03	3.8	4.9	F sand, some shell frag.
AVERAGE	17.8	22.6	3,560.0	4,520.0	6.28e-03	7.98e-03	21.4	26.7	

Notes:

- "--" Falling head slug test not performed as well level was within screened interval.
- Transmissivity calculation assumed 45 ft thickness for surficial aquifer
- Transmissivity calculation assumed 200 ft thickness for the Castle Hayne aquifer.

TABLE 2-4

SUMMARY OF POTABLE WATER SUPPLY WELLS
 WITHIN A ONE-MILE RADIUS OF SITE 44
 REMEDIAL INVESTIGATION CTO-0303
 MCAS NEW RIVER, NORTH CAROLINA

Supply Well Number	Well Depth (ft)	Screened Interval (ft)	Well Dia. (in)	Approx. Dist. and Dir.	Status of Well	Al (µg/L)	Cu (µg/L)	Fe (µg/L)	Pb (µg/L)	Mn (µg/L)	Zn (µg/L)	Chloride (µg/L)	Fluoride (µg/L)	Nitrate/Nitrite (µg/L)	Sulfate	TDS
TC-502	184	110-184	10	1 mile/ENE	On	340 (5)	ND (3)	ND	ND	ND	ND	160,000	2,200 (6)	20	41,000	840,000 (4)
NC-52	70	25-66	NA	5,000ft/ENE	-1	NA	NA	NA	NA	NA	NA	NA	NA	NA	NA	NA
TC-600	70	48-70	8	5,000ft/ENE	On	290 (5)	ND	9,800 (4)	ND	100 (4)	ND	25,000	300	80	86,000	430,000
TC-700	76	27.5-76	18	4,600ft/E	-1	270 (5)	ND	9,300 (4)	ND	120 (4)	ND	11,000	20	80	200,000	250,000
TC-901	77	46-56	8	5,000ft/ESE	Off	NA	NA	NA	NA	NA	NA	NA	NA	NA	NA	NA
TC-1251	240	120-140	NA	4,300ft/SE	On	260 (5)	ND	490 (4)	ND	120 (4)	ND	170,000	500	30	6,000	660,000 (4)
TC-1253	250	120-135	NA	1 mile/ESE	Off	330 (5)	ND	40	ND	ND	ND	60,000	1,200	ND	5,800	500,000
MCAS-106	NA (2)	NA	NA	4,000ft/SSW	Off	NA	NA	NA	NA	NA	NA	NA	NA	NA	NA	NA
MCAS-203	173	NA	NA	4,000ft/SSW	On	360 (5)	ND	470 (4)	ND	ND	ND	180,000	1,400	ND	22,000	760,000 (4)
MCAS-131	200	NA	NA	5,000ft/SSW	On	ND	60	540 (4)	7	50	20	110,000	400	50	28,000	550,000 (4)

Notes:

- The analytical data presented in this table represent detected analytes.
- (1) Status not available
 - (2) Not available
 - (3) Not detected
 - (4) TC-1254 designated as MCAS-1254 on well location map.
 - (4) Above USEPA & NC SMCL/Standard (Fe=300 µg/L, Mn=50 µg/L, TDS=500,000 µg/L)
 - (5) Above USEPA SMCL (Al=200 µg/L)
 - (6) Above NC Standard (Fl=2,000 µg/L)
- See Figure 2-6 for well locations.

SECTION 2.0 FIGURES

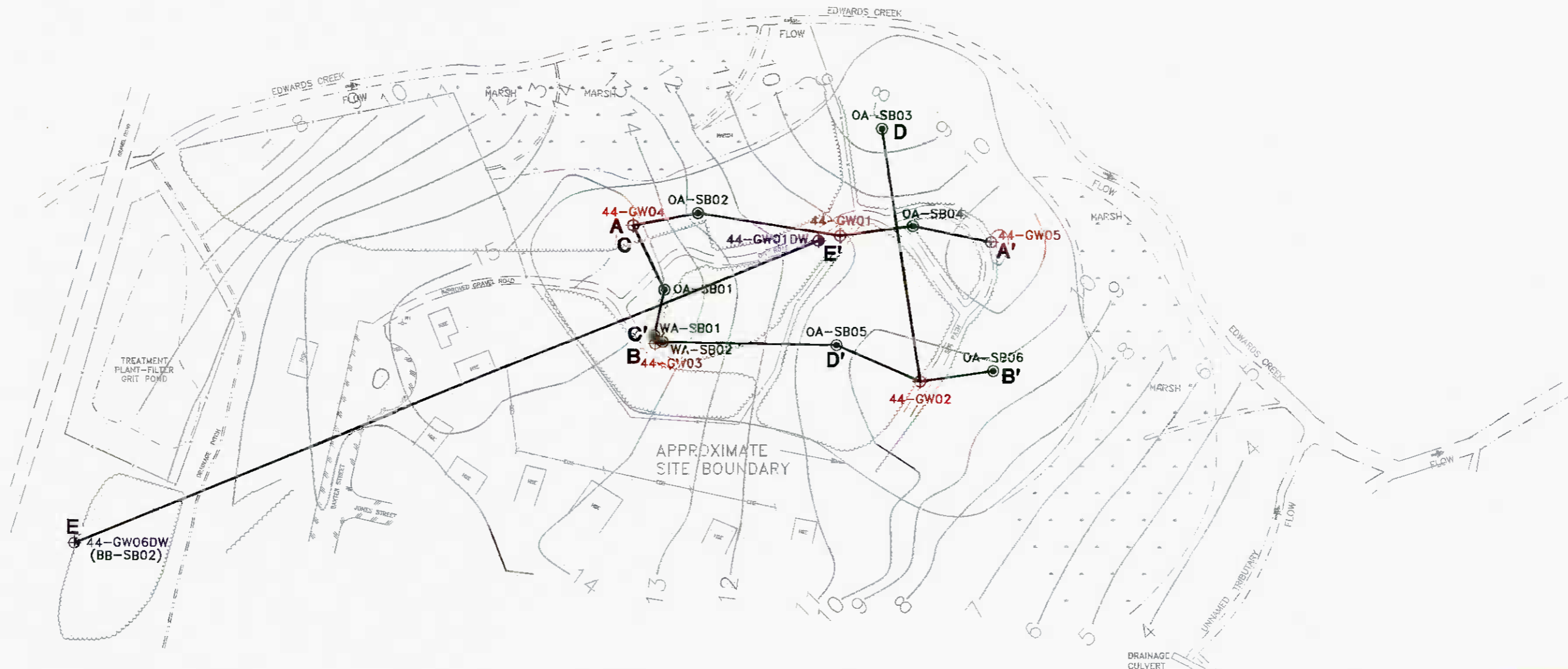

LEGEND

- | | | | |
|-----------|---------------------------------|-----------|--|
| 44-GW06 | SHALLOW MONITORING WELL | EOE | OVERHEAD ELECTRIC LINE & UTILITY POLE |
| 44-GW06DW | DEEP MONITORING WELL | —x—x— | FENCE |
| OA-SB02 | SOIL BORING LOCATION | —/—/—/— | ASPHALT ROAD |
| A—A' | CROSS SECTION TRAVERSE | - - - - - | GRAVEL OR DIRT ROAD |
| FLOW | DIRECTION OF SURFACE WATER FLOW | - - - - - | EDGE OF CREEK, DRAINAGE DITCH, MARSH OR POND |
| MARSH | MARSH | —w—w— | TREE LINE |
| | | HSE | BASE HOUSING UNIT |

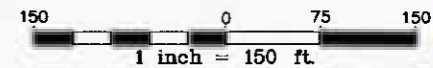
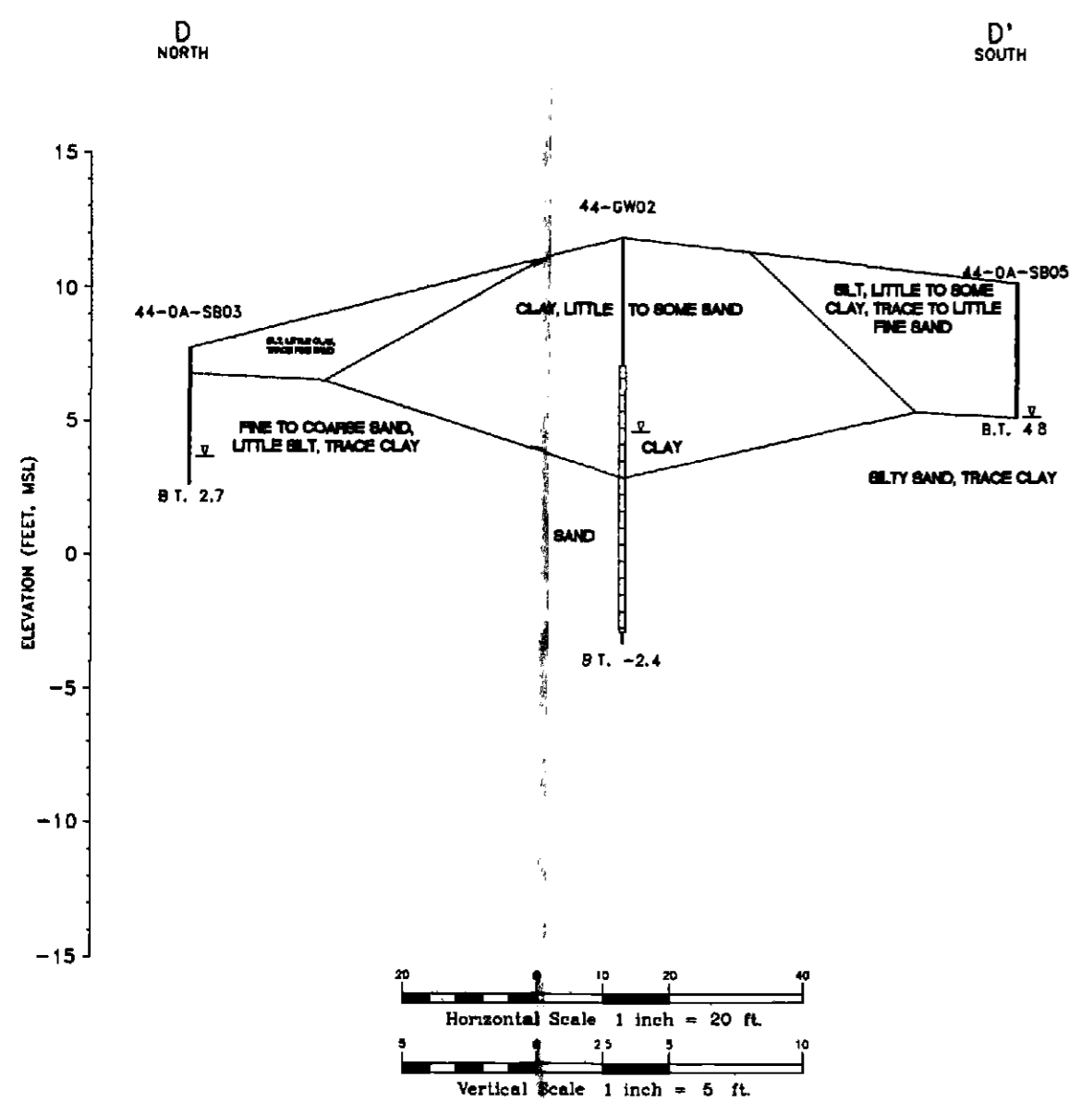
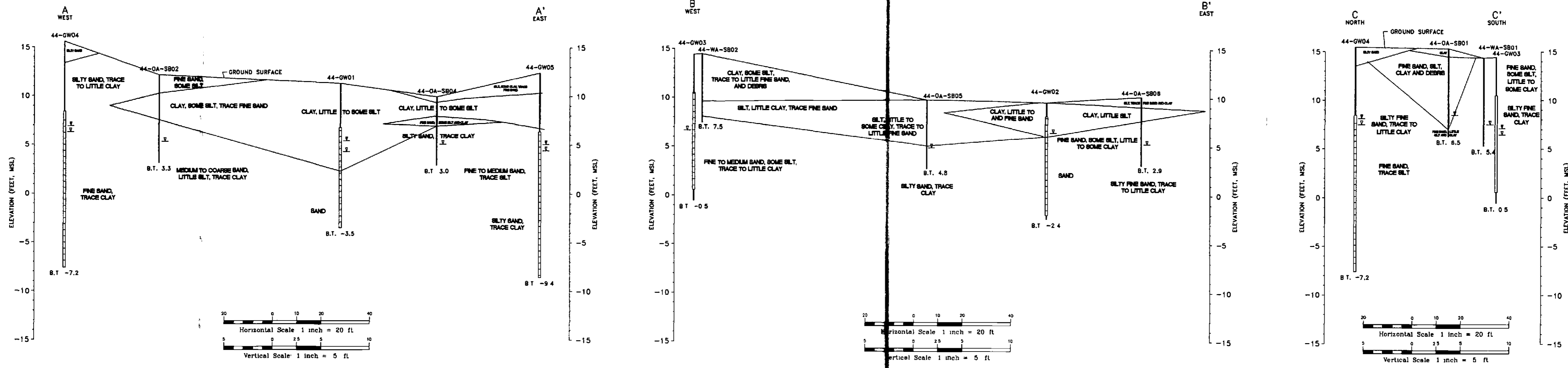

FIGURE 2-1
CROSS SECTION LOCATION AND APPROXIMATE SURFACE ELEVATION CONTOUR MAP
SITE 44, JONES STREET DUMP
REMEDIAL INVESTIGATION, CTO-0303
MARINE CORPS AIR STATION, NEW RIVER
NORTH CAROLINA

01715Y04Y



LEGEND
 - GROUNDWATER ELEVATION (5/4/85)
 - GROUNDWATER ENCOUNTERED DURING DRILLING
 - BORING TERMINATED, ELEVATION MSL
 - WELL SCREEN INTERVAL
 - PROJECTED
 - ESTIMATED
 - FORMATION CONTACT

NOTE:
 - THE SOIL BORING INFORMATION IS CONSIDERED TO BE REPRESENTATIVE OF SUBSURFACE CONDITIONS AT THE RESPECTIVE BORING LOCATIONS. SUBSURFACE CONDITIONS INTERPOLATED BETWEEN BORINGS ARE ESTIMATED BASED ON ACCEPTED SOIL ENGINEERING PRINCIPLES AND GEOLOGIC JUDGEMENT.

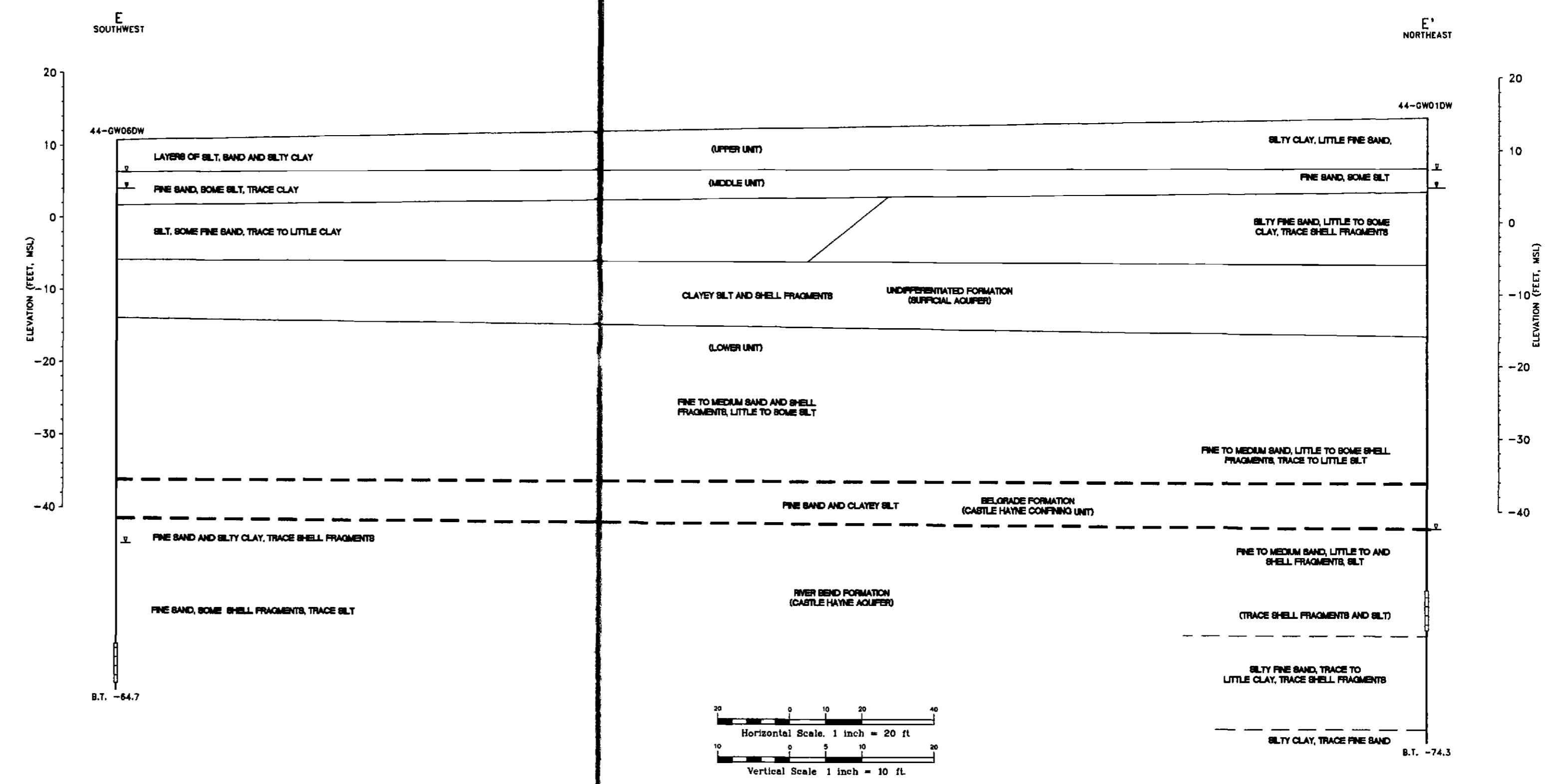

Horizontal Scale 1 inch = 20 ft
 Vertical Scale 1 inch = 10 ft

REVISIONS DRAWN WJH REVIEWED MKD S.O.# 62470-303-0000-05200 CADD# 303013RI	NORTH 	REMEDIAL INVESTIGATION, CTO-0303 MARINE CORPS AIR STATION, NEW RIVER NORTH CAROLINA		 Baker Environmental, Inc. Coraopolis, Pennsylvania	GEOLOGIC CROSS SECTIONS A-A', B-B', C-C', D-D' & E-E' SITE 44, JONES STREET DUMP		FIGURE No. 2-2
		SCALE AS SHOWN			DATE JANUARY 1995		

01715Y05X

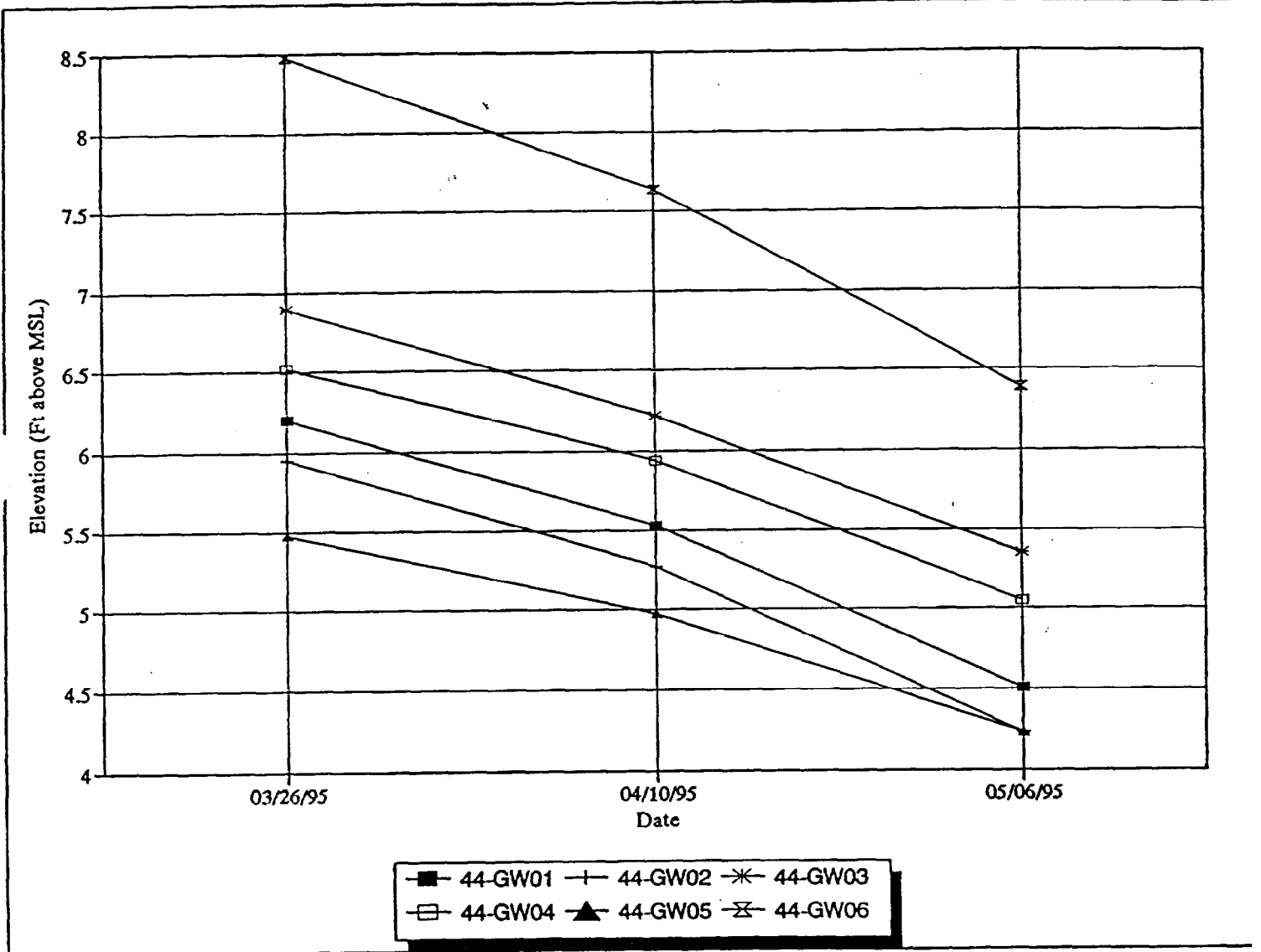

FIGURE 2-3A
 GROUNDWATER ELEVATION TREND
 AT SITE 44
 REMEDIAL INVESTIGATION CTO-03C
 MCAS NEW RIVER, NORTH CAROLIN

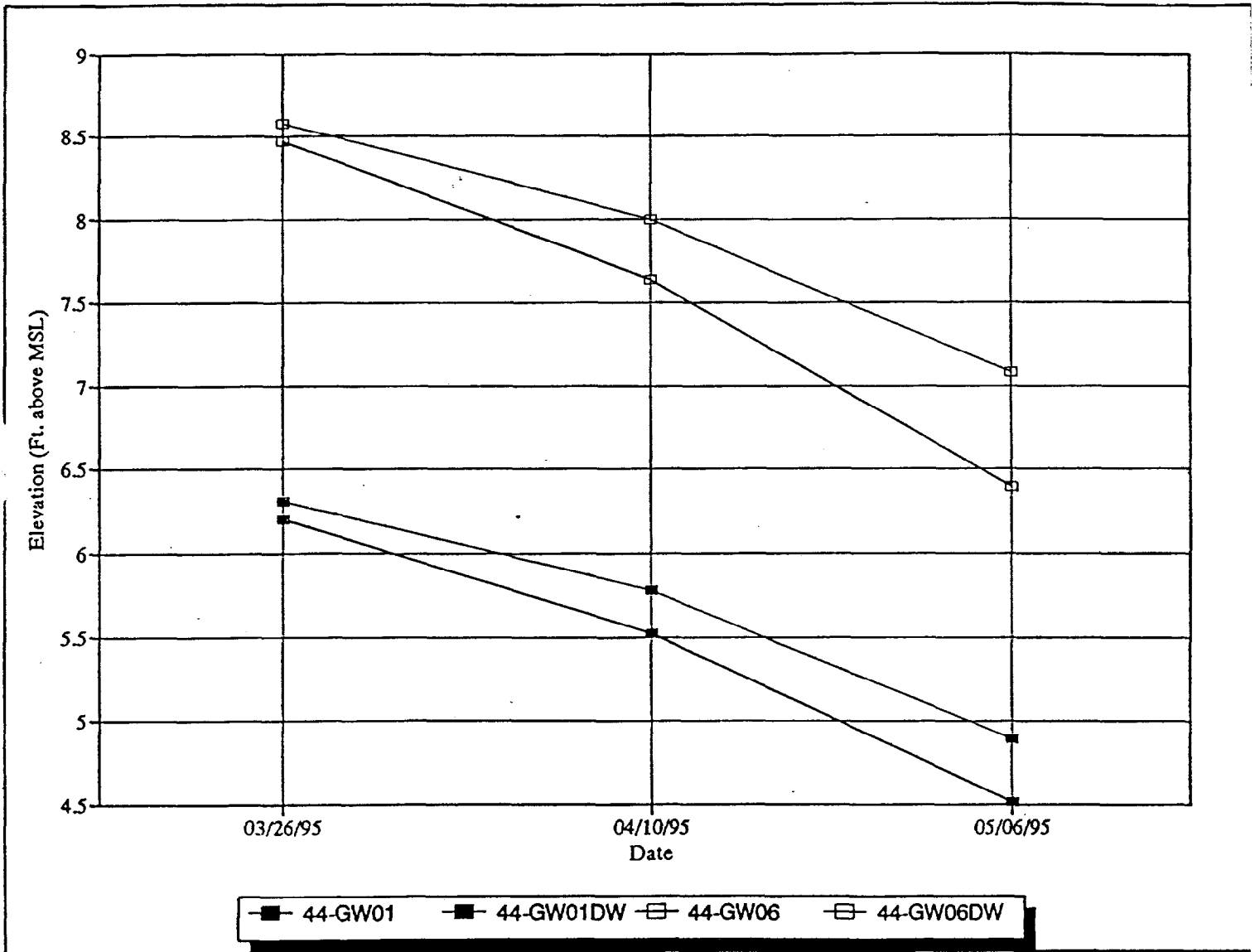
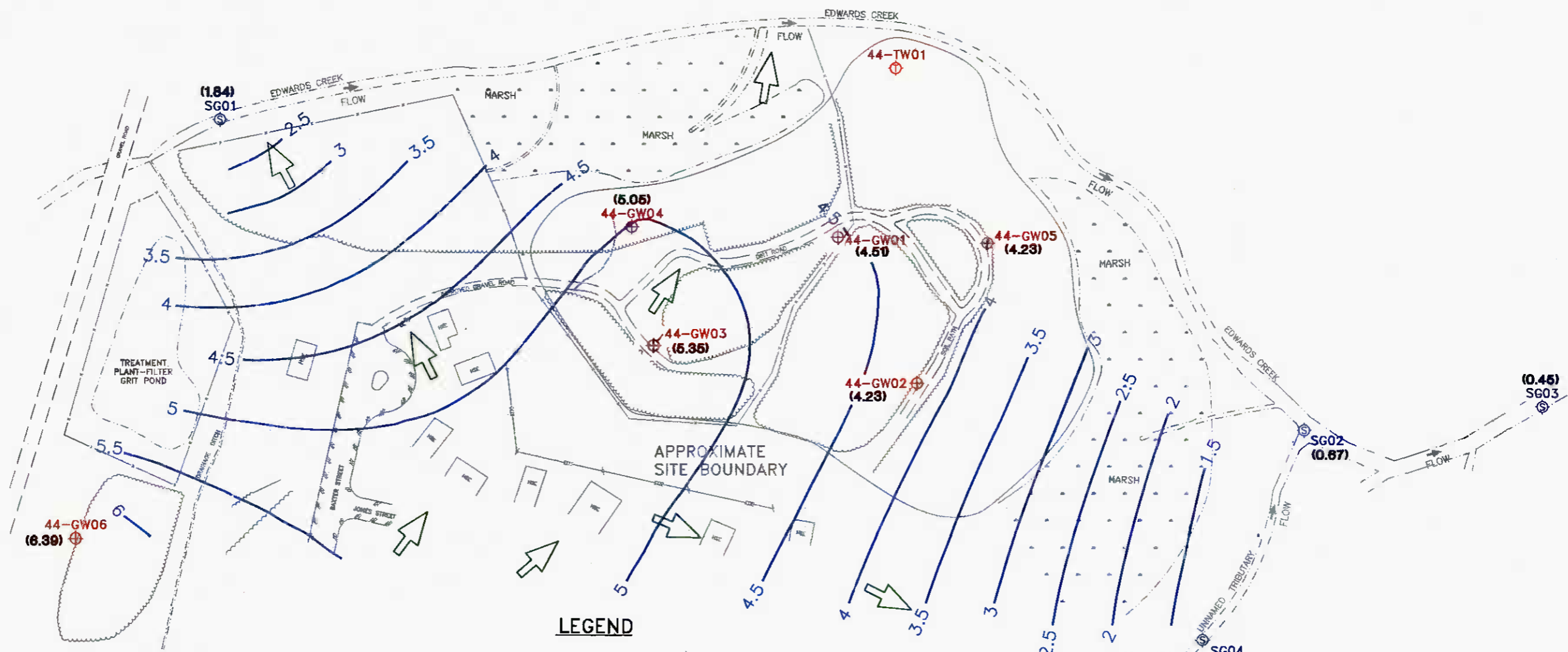

FIGURE 2-3B
GROUNDWATER ELEVATION TRENDS
AT SITE 44
REMEDIAL INVESTIGATION CTO-0303
MCAS NEW RIVER, NORTH CAROLINA



LEGEND

- | | | | |
|--------------|-------------------------------|-------------|--|
| 44-GW06
⊕ | SHALLOW MONITORING WELL | → FLOW | DIRECTION OF SURFACE WATER FLOW |
| 44-TW01
⊕ | TEMPORARY MONITORING WELL | ⊕ | MARSH |
| SG01
⊕ | STAFF GAUGE | — EOE — | OVERHEAD ELECTRIC LINE & UTILITY POLE |
| 6 — | GROUNDWATER ELEVATION CONTOUR | — x — x — | FENCE |
| (6.39) | GROUNDWATER ELEVATION | — / — / — / | ASPHALT ROAD |
| → | GROUNDWATER FLOW DIRECTION | — - - - - | GRAVEL OR DIRT ROAD |
| | | — · — · — · | EDGE OF CREEK, DRAINAGE DITCH, MARSH OR POND |
| | | ⌞ | TREE LINE |
| | | HSE | BASE HOUSING UNIT |

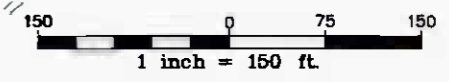

FIGURE 2-4
SURFICIAL AQUIFER GROUNDWATER
CONTOUR MAP (AUGUST 1995)
SITE 44, JONES STREET DUMP
REMEDIAL INVESTIGATION, CTO-0303
MARINE CORPS AIR STATION, NEW RIVER
NORTH CAROLINA

01715Y06Y

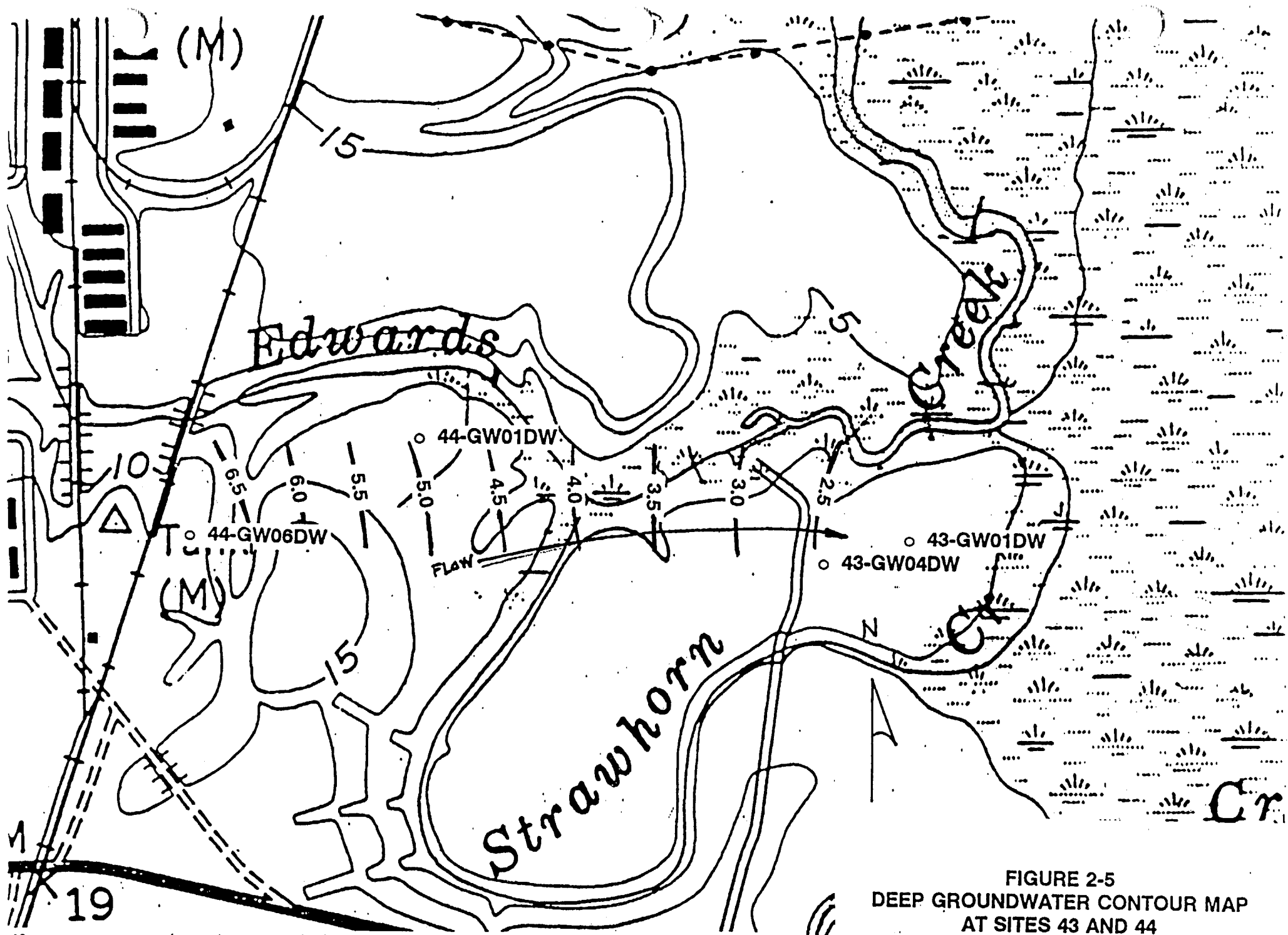
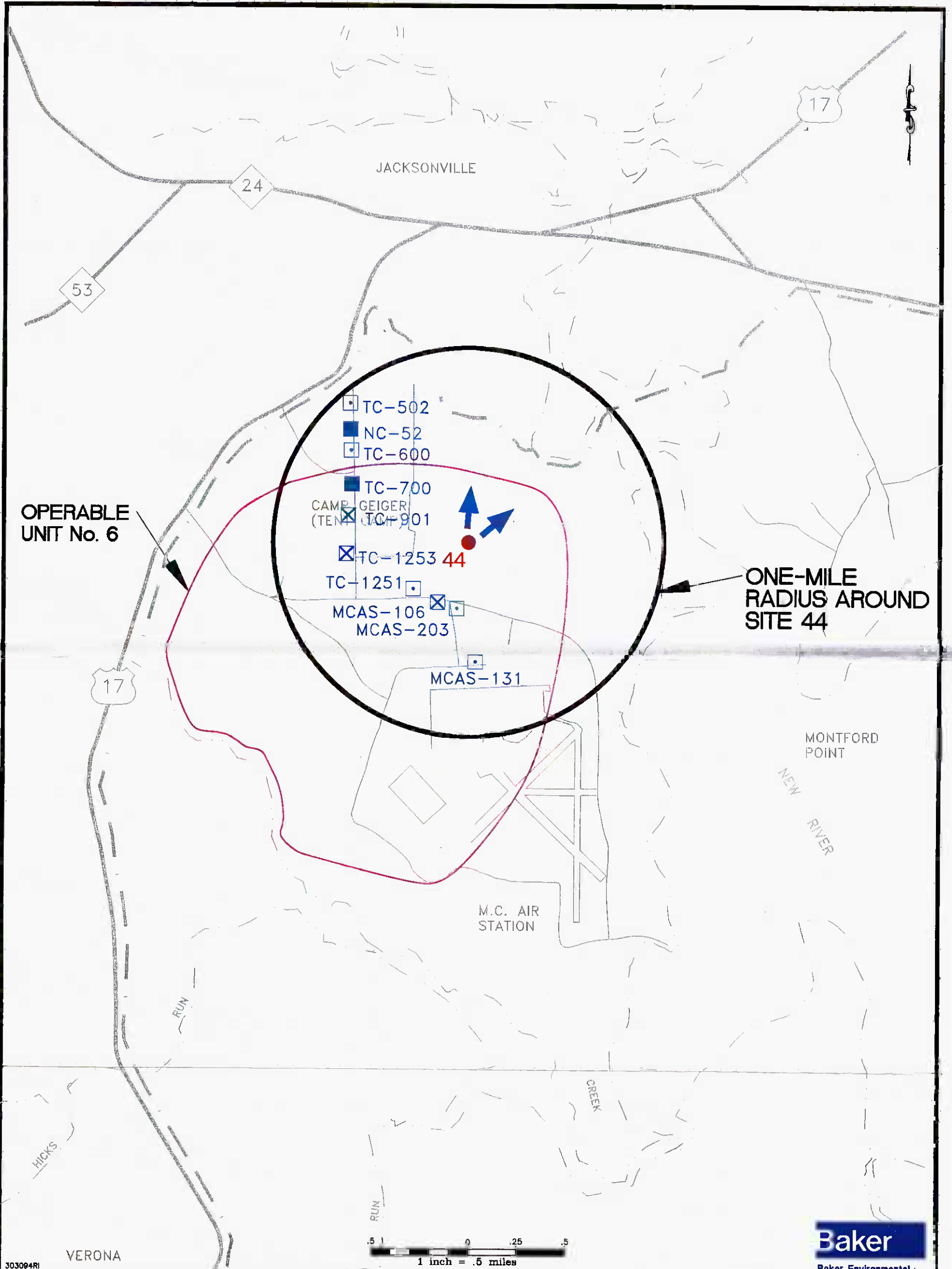

FIGURE 2-5
 DEEP GROUNDWATER CONTOUR MAP
 AT SITES 43 AND 44
 REMEDIAL INVESTIGATION CTO-0303
 MCAS NEW RIVER, NORTH CAROLINA

Note: Monitoring well locations and contours are estimated and superimposed on a USGS quadrangle (Scale approx. 1-inch = 500-feet).



OPERABLE UNIT No. 6

ONE-MILE RADIUS AROUND SITE 44

Baker
Baker Environmental, Inc.

303084R1

VERONA

LEGEND

TC-502	□	- WATER SUPPLY WELL IN SERVICE
NC-52	■	- WATER SUPPLY WELL, STATUS NOT AVAILABLE
TC-901	⊠	- WATER SUPPLY WELL OUT OF SERVICE
	➔	- APPROXIMATE DIRECTION OF GROUNDWATER FLOW FROM SITE







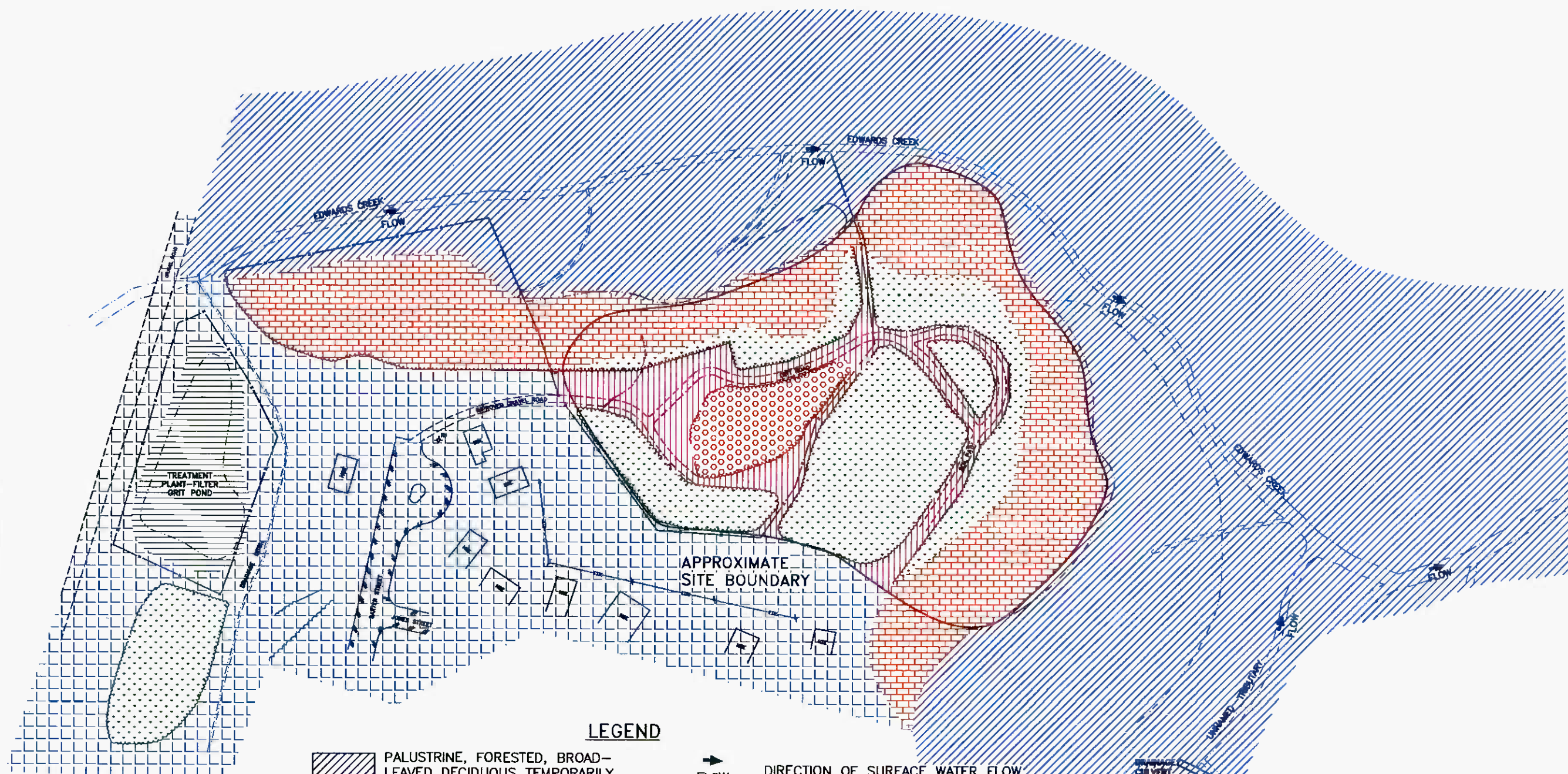



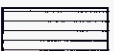

SOURCE: LANTDIV, OCT. 1991

FIGURE 2-6
POTABLE WATER SUPPLY WELLS
WITHIN A ONE-MILE RADIUS
SITE 44, JONES STREET DUMP
REMEDIAL INVESTIGATION, CTO-0303
MARINE CORPS BASE, CAMP LEJEUNE
NORTH CAROLINA

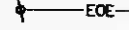
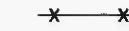
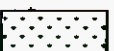
01715YB2Y

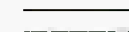

LEGEND

- | | | | | | | |
|--|---------------------|---|---|---|---------------------|---------------------------------|
|  | OPEN AREA |  | PALUSTRINE, FORESTED, BROAD-LEAVED DECIDUOUS TEMPORARILY FLOODED, PARTIALLY DRAINED WETLAND |  | FLOW | DIRECTION OF SURFACE WATER FLOW |
|  | HOUSING/OTHER |  | PALUSTRINE, UNCONSOLIDATED BOTTOM, PERMANENTLY FLOODED DIKED WETLAND |  | MARSH | |
|  | UPLAND FOREST |  | |  | FENCE | |
|  | MIXED FOREST |  | |  | GRAVEL OR DIRT ROAD | |
|  | YOUNG PINES IN OPEN |  | |  | TREE LINE | |
| | |  | | | HSE | BASE HOUSING UNIT |

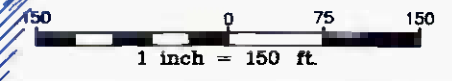

FIGURE 2-7
BIOHABITAT MAP
SITE 44, JONES STREET DUMP
REMEDIAL INVESTIGATION, CTO-0303
MARINE CORPS AIR STATION, NEW RIVER
NORTH CAROLINA

3.0 STUDY AREA INVESTIGATIONS

The field investigation program at OU No. 6, Site 44, was initiated to detect and characterize potential impacts to human health and the environment resulting from past waste management activities. This section discusses the site-specific RI field investigation activities that were conducted to fulfill the objective. The RI field investigation of OU No. 6 commenced on February 20, 1995 and continued through May 10, 1995. The RI field program at Site 44 consisted of a site survey; a soil investigation, which included sampling and test pit excavations; a groundwater investigation, which included monitoring well installation, sampling, and aquifer testing; a surface water and sediment investigation; a habitat evaluation; and a bioassay study. The following sections detail the various investigation activities carried out during the RI.

3.1 Site Survey

The site survey task was performed in two phases: Phase I - Initial Survey of Site Features; and Phase II - Post Investigation Survey of Monitoring Wells and Sampling Locations. Phase I of the survey task was conducted at Site 44 during December of 1994. Based upon the Initial Site Assessment Study (WAR, 1983) and Site Inspection Report (Baker, 1994a), surface features within and surrounding the suspected disposal areas were surveyed. The proposed soil boring and monitoring well locations identified in the Final RI/FS Work Plan for OU No. 6 (Baker, 1994b), were subsequently located as part of the Phase I survey and marked with wooden stakes. Each sample location was assigned a unique identification number that corresponded to the site and media to be sampled.

Phase II of the site survey task was completed at Site 44 during the week of May 10, 1995. During Phase II, all existing and newly installed monitoring wells were surveyed. Supplemental or relocated soil borings and exploratory test pits completed during the investigation were also surveyed. A number of soil borings were relocated from the locations proposed in the project plans (i.e., moved more than ten feet from their proposed locations) due to the presence of either underground or overhead utilities. Soil test borings were also moved from their proposed locations based upon observed site conditions. Additionally, staff gauges installed in Edwards Creek were also surveyed during Phase II. Latitude, longitude, and elevation in feet above mean sea level (msl) were recorded for each surveyed point.

3.2 Soil Investigation

The soil investigation performed at Site 44 was intended to:

- Assess the nature and extent of contamination that may have resulted from previous disposal practices or site activities;
- Assess the human health, ecological, and environmental risks associated with exposure to surface and subsurface soils; and
- Characterize the geologic setting of the study area.

The subsections which follow describe soil sample collection procedures, soil boring locations, and the analytical program initiated during the soil investigation at Site 44.

3.2.1 Soil Sampling Procedures

Sampling activities at Site 44 commenced on March 8, 1995. Soil collection was performed using a direct-push (GeoProbe™) sampling system. Borings were advanced by either a truck-mounted rig or by a hand sampler unit. The direct-push sampling system employed a stainless steel cutting shoe and collection tube. A dedicated acetate liner, inserted into the stainless steel collection tube, was used to collect and then extrude soil samples for field and laboratory analyses. All soil sampling activities conducted at Site 44 were performed in Level D personnel protection. Soil cuttings obtained during the soil investigation were collected, handled, and stored according to the procedures outlined in Section 3.7.

Two types of borings were installed during the soil investigation: exploratory test borings (i.e., borings installed for sample collection and description of subsurface units) and borings advanced for the purpose of monitoring well installation. Selected soil samples from each of the two types of borings were submitted for laboratory analysis (see Section 3.2.4). Soils obtained from exploratory borings were collected from the surface (i.e., ground surface to a depth of twelve inches) and at continuous two-foot intervals starting at one foot below ground surface. Continuous sample collection proceeded until the boring was terminated at the approximate depth of the water table, which varied at Site 44 from 3 to 9 feet below ground surface. An additional soil sample was collected from below the water table to confirm groundwater depth and ensure that the true water table had been encountered (i.e., not a perched zone).

Samples were collected for soil description from the ground surface and at continuous two-foot intervals to the water table. Each soil was classified in the field by a geologist using the Unified Soil Classification System (USCS) in accordance with the visual-manual methods described by the American Society for Testing and Materials (ASTM, 1993a). Descriptions were recorded in a field logbook and later transposed onto boring log records. Soil classification included characterization of soil type, grain size, color, moisture content, relative density, plasticity, and other pertinent information such as indications of contamination. Descriptions of site soils are provided on Test Boring Records in Appendix A and on Test Boring and Well Construction Records in Appendix B.

Surface and selected subsurface (i.e., greater than one foot below ground surface) soil samples were retained for laboratory analysis from each of the soil borings. Both surface and subsurface samples were collected to evaluate the nature and extent of potentially impacted soils and to perform the human health risk assessment; however, only the surface soils were employed for the ecological risk assessment. A summary of test boring identification numbers, boring depths, sampling intervals, and laboratory analyses for Site 44 soil samples is provided in Tables 3-1 and 3-2.

A minimum of two samples were retained for laboratory analysis from each of the soil boring locations. Each soil sample was prepared and handled according to USEPA Region IV Standard Operating Procedures (SOPs). Samples collected for volatile organic analysis were extracted with a stainless-steel spoon from different sections of the extruded soil core so that the resulting composite was representative of the entire sampling interval. Precautions were taken not to aerate the sample, thus minimizing volatilization. Samples retained for other analytical parameters (e.g., semivolatiles, pesticides, PCBs, and metals) were thoroughly homogenized prior to being placed in the appropriate laboratory containers.

Following sample collection, each sample retained for laboratory analysis was stored on ice in a cooler. Sample preparation also included documentation of sample number, depth, location, date,

time, and analytical parameters in a field logbook. Chain-of-Custody documentation, copies of which are provided in Appendix D, included information such as sample number, date, time of sampling, and sampling personnel, accompanied the samples to the laboratory. Samples were shipped by overnight courier to the laboratory.

3.2.2 Sampling Locations

Representative samples from the study area were collected and submitted for laboratory analysis of target compound list (TCL) organics (i.e., volatiles, semivolatiles, pesticides, and PCBs) and target analyte list (TAL) metals. A total of 13 test borings were sampled during the soil investigation at Site 44. Two additional borings, to the west of the study area, were advanced to assess background contaminant concentrations (44-BB-SB01 and 44-BB-SB02).

Soil samples were collected throughout Site 44 as shown on Figure 3-1. The sampling distribution employed was intended to identify if contamination was present and, if so, to evaluate the vertical and horizontal extent within the study area. The soil sampling program at Site 44 focused on known or suspected disposal areas. Previous investigatory data and background reports were used to locate potential sampling locations.

A total of 13 borings were advanced to assess suspected waste disposal at Site 44; three of those borings were utilized for the installation of monitoring wells. Four of the 13 boring locations were completed in an area immediately surrounding monitoring well 44-GW03, identified in the Final RI/FS Work Plan for OU No. 6 (Baker, 1994b). The remaining nine soil borings were completed at the various locations throughout the site, as shown on Figure 3-1.

3.2.3 Exploratory Test Pits

A total of three exploratory test pits were completed in conjunction with the soil investigation at Site 44 (refer to Figure 3-1). The exploratory test pit investigation was conducted to assess the nature of any buried material within suspected disposal areas. Excavation logs, provided in Appendix C, describing the contents of each test pit were maintained during field operations. A soil sample from one test pit, 44-TP03, was submitted for laboratory analysis of compounds associated with toxicity characteristic leaching procedure (TCLP) and Resource Conservation and Recovery Act (RCRA) hazardous waste characteristics. Laboratory confirmation analysis of excavated soil was necessary when staining was evident or when organic contamination was indicated through field screening.

Potential test pit locations were identified through visual site inspection and use of a hand-held magnetometer. The visual site inspection sought to identify signs of contamination or waste disposal activity such as soil staining, debris, fill areas, or depressions. In conjunction with the visual site inspection, a magnetometer was employed during the test pit investigation to identify buried metallic objects. Because of the presence and wide distribution of metallic debris throughout the study area, only locations with magnetic detections indicating metallic objects greater than three feet in length were selected for excavation activities.

During the excavation of exploratory test pits by backhoe, Level B personal protective equipment (e.g., supplied air) was employed. In general, test pit dimensions measured 10 to 15 feet in length and 2 to 3 feet in width. The depth of each test pit varied according to the depth of the encountered water table and the total depth of fill material.

3.2.4 Analytical Program

The analytical program initiated during the soil investigation at Site 44 focused on suspected contaminants of concern, as indicated by information regarding previous disposal practices and investigation results. Each of the 13 soil samples were analyzed for TAL metals and full TCL organics (i.e., volatiles, semivolatiles, pesticides, and PCBs). Samples were prepared and handled as described in the previous section.

The soil sample from the selected exploratory test pit was submitted for laboratory analysis of the compounds reported as part of TCLP and RCRA hazardous waste characteristics. Laboratory confirmation analysis of excavated soil was requested when staining was evident or when organic contamination was indicated by field screening. The TCLP samples were employed to characterize the nature of the visually contaminated material. Samples were prepared and handled as described in the previous section. Tables 3-1 through 3-3 present a summary of requested soil analyses.

In addition to chemical analyses, a thin-walled tube (i.e., shelly tube) was employed to collect, according to ASTM D-1587 (ASTM, 1994), an undisturbed sample of the semi-confining layer that separates the surficial and Castle Hayne aquifers. The sample was tested in accordance with the following procedures:

- ASTM D-422 - Particle Size Analysis of Soils (ASTM, 1990a)
- ASTM D-4418 - Liquid Limit, Plastic Limit, and Plasticity Index of Soils (ASTM, 1993b)
- ASTM D-5084 - Hydraulic Conductivity of Saturated Porous Materials (ASTM, 1990b)

Findings from these and USCS soil classification analyses are presented in Appendix L.

3.2.5 Quality Assurance and Quality Control

Field QA/QC samples were collected during the soil investigation. These samples were obtained to: (1) monitor that decontamination procedures were properly implemented (equipment rinsate samples); (2) evaluate field methodologies (duplicate samples); (3) establish field background conditions (field blanks); and (4) evaluate whether cross-contamination occurred during sampling and shipping (trip blanks). Data Quality Objectives (DQOs) for the QA/QC samples were implemented in accordance with DQO Level IV as defined in the Environmental Compliance Branch SOPs and Quality Assurance Manual, USEPA Region IV (USEPA, 1991). This DQO level is equivalent to the Naval Facilities Engineering Service Center (NFESC) DQO Level D, as specified in the "Sampling and Chemical Analysis Quality Assurance Requirements for the Navy Installation Restoration Programs" document (NEESA, 1988).

Four types of field QA/QC samples were collected and analyzed including: duplicate samples; equipment rinsates samples; field blanks; and trip blanks. The definition of each is listed below (USEPA, 1991):

- Duplicate Sample: Two or more samples collected simultaneously into separate containers from the same source under identical conditions.
- Equipment Blanks: Equipment field blanks (or rinsate blanks) are defined as samples which are obtained by running organic free water over/through sample collection equipment after it has been cleaned. These samples are used to determine if decontamination procedures were adequate. A minimum of one equipment blank per sample media was collected daily, however, only every other blank was analyzed.
- Field Blanks: Organic-free water is taken to the field in sealed containers and poured into the appropriate sample containers at designated locations. This is done to determine if contaminants present in the area may have an affect on the sample integrity.
- Trip Blanks: Trip blanks are prepared prior to the sampling event, placed in the actual sample container, and kept with the investigative samples throughout the sampling event. They are then packaged for shipment with the other samples and sent for analysis. At no time after their preparation are the sample containers to be opened before they return to the laboratory. Field sampling teams utilize volatile organic trip blanks to determine if samples were contaminated during storage and transportation back to the laboratory. If samples are to be shipped, trip blanks are to be provided for each shipment but not necessarily for each cooler (i.e., trip blanks in coolers with samples for VOC analyses only).

Table 3-4 summarizes field QA/QC sample types, sample frequencies, the number of QA/QC samples, and parameters analyzed. Field QA/QC samples were collected at Site 44 according to the procedures outlined in the USEPA Region IV SOPs.

3.2.6 Air Monitoring and Field Screening

Several air monitoring and field screening procedures were implemented during soil investigation activities at Site 44. Ambient air monitoring for volatile contaminants was performed at each open borehole using a photoionization detector (PID). During exploratory test pit operations, the ambient air was monitored for volatile organics with both a PID and a flame ionization detector (FID).

Soil samples were field screened for volatile organic contaminants with a PID. Excavated soil from exploratory test pits was screened with both PID and FID. Measurements obtained in the field were recorded in a logbook and later transposed onto the Test Boring Records and the Well Construction Records (provided in Appendices A, B, and C). Prior to daily monitoring, the field instruments were calibrated and documentation was recorded in a field logbook and on appropriate calibration forms.

3.3 Groundwater Investigation

The groundwater investigation performed at Site 44 was intended to:

- Assess the nature and extent of contamination that may have resulted from previous disposal practices or site activities;

- Assess human health and environmental risks associated with exposure to groundwater; and
- Characterize the hydrogeologic setting of the study area.

The subsections which follow describe well installation procedures, sample collection procedures, the analytical program, and hydraulic conductivity test procedures employed during the groundwater investigation at Site 44.

3.3.1 Monitoring Well Installation

Three shallow Type II monitoring wells (i.e., wells installed without casing to seal off a semi-confining or confining layer) were installed at Site 44 during March of 1995. Locations of the newly installed monitoring wells are depicted on Figure 3-2. The three shallow monitoring wells were situated spatially to intercept potentially impacted groundwater from the suspected disposal areas, and to characterize the nature and horizontal extent of possible contamination. The existing and newly-installed monitoring wells were also used to evaluate groundwater flow patterns within the upper portion of the surficial aquifer. In addition to the shallow monitoring wells, two deep Type III monitoring wells (i.e., wells installed with casing to seal off a confining or semi-confining layer) were also installed during March of 1995, at Site 44 (refer to Figure 3-2). The two deep monitoring wells were installed to assess the nature and vertical extent of contamination and to evaluate the flow pattern of the deeper aquifer (i.e., the Castle Hayne aquifer). Placement of the newly installed monitoring wells was based on review of previous investigation analytical data.

Shallow monitoring wells were installed after the pilot hole test boring was advanced to the desired depth. Each borehole was reamed with 6-1/4-inch internal diameter (ID) hollow stem augers prior to shallow well installation. Shallow well depths ranged from 18 to 22 feet below ground surface. In general, the shallow wells were installed approximately 10 feet below the water table encountered during the pilot hole test boring. Shallow monitoring wells were installed with screened intervals bi-secting the water table sufficiently to compensate for seasonal variations in the water table which is known to fluctuate from two to four feet. The two deep wells were set at depths of 70 and 75 feet below ground surface. Well construction details are summarized in Table 3-5, and well construction diagrams are shown on the Test Boring and Well Construction Records provided in Appendix B.

The two deep monitoring wells were installed upon completion of pilot hole test borings which were advanced using the wash and mud rotary drilling methods. Each borehole was drilled with a 6-inch wing bit prior to well installation. The two deep monitoring wells were screened at intervals just below the semi-confining unit in the upper portion of the Castle Hayne aquifer. Screened intervals for the two deep wells ranged from approximately 65 to 75 feet below ground surface (refer to Table 3-5 and Appendix B for well construction details).

All of the permanent monitoring wells were constructed of two-inch nominal diameter, Schedule 40, flush-joint and threaded, polyvinyl chloride (PVC) casing. Justification for the use of PVC casing is provided in Appendix B of the Field Sampling and Analysis Plan for Operable Unit No. 6 (Baker, 1994b). Each shallow well utilized a 15-foot screened interval comprised of a 10- and 5-foot long No. 10 (i.e., 0.01 inch) slotted screen sections. Deep monitoring wells were constructed with five-foot No. 10 slotted screen sections. A fine-grained sand pack (i.e., No. 1 silica sand), extending approximately 2 feet above the top of the screen, was placed in the annulus between the screen and the borehole wall from inside the augers during shallow well installation. The sand pack was poured

manually down the borehole during deep well installation and checked continuously with a weighted tape measure to determine sand pack depth. A two- to three-foot sodium bentonite pellet seal was placed above the sand pack by dropping pellets down the borehole. The bentonite pellets were hydrated with potable water after placement. A sodium bentonite slurry was used to backfill the annular space from above the bentonite pellet seal to the bottom of the steel casing (i.e., above the semi-confining unit). The remaining annular space was backfilled with a mixture of Portland cement and five percent powdered bentonite. During construction of the Type III deep wells, portland cement was used to secure six-inch steel casing to the uppermost portion of the semi-confining layer. A five-foot by five-foot concrete pad was placed around the protective well casing and four protective bollard posts were installed around the corners of the concrete pad. A four-inch protective well casing with locking cover was placed over the well and set into the cement. Well tags, which provide construction information, were installed at the top of each well. Typical shallow Type II and Type III well construction details are shown on Figures 3-3 and 3-4.

One temporary well was employed to assess groundwater conditions in a low-lying area adjacent to the northern boundary and Edwards Creek which was not suited for permanent well construction. The temporary well was constructed of one-inch nominal diameter, Schedule 40, flush-joint and threaded PVC casing placed in an open borehole. A filter sock was used to filter fine materials from the surrounding formation. Immediately following sample acquisition the temporary well was removed.

3.3.2 Monitoring Well Development

Following well construction and curing of the bentonite seal and cement grout, each newly installed monitoring well was developed to remove fine-grained sediment from the screen and sandpack and to establish interconnection between the well and the surrounding formation. The shallow wells were developed by a combination of surging and pumping. The deep wells were developed using a forced air system, equipped with a filter, and "lifting" the water out of the well. Typically, 20 to 40 gallons of water were evacuated from the shallow wells, followed by 10 minutes of surging, then continued pumping. Between 100 and 250 gallons of water, approximately 3 to 5 borehole volumes, were evacuated from the deep wells. Groundwater recovered during well development was temporarily stored in drums, then transferred into on-site storage tanks (refer to Section 3.7). Pumping hoses, constructed of flexible PVC, were used once and discarded to minimize the potential for cross contamination.

Three to five borehole volumes were removed from each well, where conditions permitted, until the groundwater was essentially sediment-free. Measurements of pH, specific conductance, and temperature were generally recorded after each volume was removed to assist in assessing well stabilization. Additionally, periodic flow and volume measurements were also recorded during development to evaluate flow rates of the shallow water-bearing zone. Well Development Forms that summarize this information are provided in Appendix E.

3.3.3 Water Level Measurements

Static water level measurements were collected after all well development activities had been completed. Measurements were recorded from top-of-casing (TOC) reference points marked on the PVC casing at each existing and newly-installed well. Water level measurements were collected on March 26, April 10, and May 6, 1995. Groundwater measurements were recorded using an electric measuring tape which were recorded to the nearest 0.01 foot. Water level data from site monitoring

wells and staff gauges were collected within a three-hour period. A summary of water level measurements is provided in Table 3-6.

3.3.4 Aquifer Testing

Well-head tests (i.e., slug tests) were performed on selected wells at Site 44 as part of the groundwater investigation. Aquifer testing results, provided in Appendix N. Both falling- and rising-head tests were performed to approximate individual well characteristics and to provide generalized information regarding aquifer parameters within the study area.

3.3.5 Sampling Locations

Groundwater samples were collected from three existing shallow wells (44-GW01, 44-GW02, and 44-GW03), the three newly installed shallow wells (44-GW04, 44-GW05, and 44-GW06), one temporary well (44-TW01), and the two newly installed deep wells (44-GW01DW and 44-GW04DW) at Site 44. The locations of the newly installed, temporary, and existing monitoring wells are shown on Figure 3-2. The groundwater sampling round was conducted at Site 44 in April of 1995.

3.3.6 Sampling Procedures

Groundwater samples were collected to assess whether contamination was present in the shallow and deep aquifers resulting from previous disposal practices at Site 44. Based upon previous investigative results and historical records, the contaminants of concern were volatiles, aromatic hydrocarbons (PAHs), and metals. Accordingly, the sampling program initiated at Site 44 focused on these contaminants.

Prior to groundwater purging, a water level measurement from each well was obtained according to procedures outlined in Section 3.3.3. The total well depth was also recorded from each well to the nearest 0.1 foot using a decontaminated steel tape. Water level and well depth measurements were used to calculate the volume of water in each well and the volume of water necessary to purge the well.

A minimum of three to five well volumes were purged from each well prior to sampling. Measurements of pH, specific conductance, temperature, and turbidity were taken after each well volume was purged to ensure that the groundwater characteristics had stabilized before sampling. These measurements were recorded in a field logbook and are provided in Table 3-7. Purge water was contained and handled as described in Section 3.7.

During the groundwater sampling event, a low flow well purging and sampling technique was employed. The sampling methodology was developed in response to conversations with USEPA Region IV personnel in Athens, Georgia. A peristaltic pump (GeoPump), with the intake set two to three feet into the static water column, was used to purge each of the wells. While purging groundwater from each of the monitoring wells, a flow rate of less than 0.25 gpm was maintained. Samples collected for both organic and metal analyses were obtained directly from the pump discharge. The Teflon™ tubing was decontaminated with a Liquinox soap solution and thoroughly rinsed with deionized water (refer to Section 3.6 for decontamination procedures). A dedicated one-foot section of silicon pump-head tubing was used during purge and sampling activities at each well.

Rinsate blanks were collected from the Teflon™ and silicon tubing to verify that proper decontamination procedures were being followed.

Preparation of groundwater samples incorporated procedures similar to those described for soil samples. Sample information, including well number, sample identification, time and date of sample collection, samplers, analytical parameters, and required laboratory turnaround time, was recorded in a field logbook and on the sample labels. Chain-of-custody documentation (provided in Appendix D) accompanied the samples to the laboratory.

3.3.7 Analytical Program

Groundwater samples from three existing shallow wells, three newly installed shallow wells, two newly installed deep wells, and one temporary well were submitted for laboratory analysis from Site 44. Samples were analyzed for full TCL organics (i.e., volatiles, semivolatiles, pesticides, and PCBs), TAL total metals, total suspended solids (TSS), and total dissolved solids (TDS). In addition, the groundwater sample obtained from 44-GW01 was also analyzed for TAL dissolved metals. Table 3-8 provides a summary of groundwater samples submitted for laboratory analysis during the groundwater investigation. The groundwater samples were analyzed using Contract Laboratory Program (CLP) protocols and Level IV data quality.

3.3.8 Quality Assurance and Quality Control

Field QA/QC samples were also submitted for analyses during the groundwater investigation. These samples included trip blanks, equipment rinsates, and duplicates. Equipment rinsates were collected from the peristaltic pump and Teflon™ tubing after decontamination was completed and prior to reuse. Section 3.2.5 provides a summary of QA/QC samples collected during the investigation. Table 3-9 summarizes the QA/QC sampling program employed for the groundwater investigation conducted at Site 44.

3.3.9 Field Screening and Air Monitoring

Air monitoring and field screening procedures for volatile organic vapors implemented at Site 44 included the screening of well heads and the purged groundwater with a PID. Measurements obtained in the field were recorded in a field logbook. Prior to daily monitoring, the field instruments were calibrated and documentation was recorded in a field logbook and on calibration forms.

3.4 Surface Water and Sediment Investigations

An overview of the surface water and sediment investigations conducted at Site 44 is provided in this section. Surface water and sediment samples were collected at Site 44 during May of 1995. A supplemental round of surface water samples were collected from Edwards Creek in September of 1995. The subsections which follow describe the surface water and sediment sampling locations, sampling procedures, analytical program, and quality assurance and quality control program for Site 44.

3.4.1 Sampling Locations

A total of 8 surface water and 16 sediment samples were collected at Site 44 during the initial sampling event in May of 1995. Each sampling station yielding one surface water and two sediment samples. Five of the sampling stations were located in Edwards Creek and three were located in an unnamed tributary to Edwards Creek. Surface water samples were assigned the designation "SW" and "SD" was specified for identification of sediment samples.

An additional eight samples were later collected to more adequately assess the extent of surface water contamination in Edwards Creek. The eight samples from Edwards Creek were submitted in September of 1995 for laboratory analysis of volatile organic compounds only. Based upon the results of the initial surface water sampling event, four of the eight additional samples were collected from previously sampled locations (44-EC-SW01 through 44-EC-SW04). The remaining four additional sample locations were situated upgradient of the initial sampling stations. Figure 3-5 depicts the locations of the surface water and sediment sampling locations.

3.4.2 Sampling Procedures

At each of the surface water sampling stations, samples were collected by dipping containers directly into the water. Samples to be analyzed for volatiles were obtained first, samples for additional analytical fractions collected immediately following. Care was taken to avoid excessive agitation that could result in loss of VOCs. Water quality readings were taken at each sampling station (i.e., pH, dissolved oxygen, salinity, specific conductance, and temperature). The water quality readings compiled during the surface water and sediment investigation are presented in Table 3-10.

Sediment samples were collected below the aqueous layer by driving a sediment corer, equipped with a disposable tube, into the sediments. The sediment was extruded from the disposable sampling tube and placed into the appropriate sample containers. Sampling containers were provided by the laboratory and certified to be contaminant free. The volatile fraction was collected first, followed by the remaining analytical parameters. Samples to be analyzed for TCL semivolatiles, pesticides, PCBs, total organic carbon (TOC), and TAL metals were thoroughly homogenized before the sample jars were filled. The first 6 inches of sediment at each station were submitted for analyses separately from sediments collected in the 6- to 12-inch depth range. Surface water and sediment samples were collected at downstream sampling locations first. All sample locations were marked by placing a pin flag or wooden stake at the nearest point along the bank.

3.4.3 Analytical Program

The analytical program at Site 44 was intended to assess the nature and extent of contamination in surface waters and sediments that may have resulted from past disposal practices. As a result, the analytical program focused on suspected contaminants of concern, based upon knowledge of suspected wastes and the overall quality of surface water and sediment. Both surface water and sediment samples were analyzed for full TCL organics and TAL metals. Surface water samples were also analyzed for TAL dissolved metals and hardness. In addition to organic and inorganic analyses, sediment samples were also analyzed for TOC and grain size.

An additional eight surface water samples from Edwards Creek were analyzed for TCL volatiles only. The additional samples were requested as a result of analytical data gathered during the initial sampling event. Volatile organic compounds were observed in Edwards Creek surface water

samples with increasing upgradient concentrations. A summary of the surface water and sediment analytical program is provided in Table 3-11.

3.4.4 Quality Assurance and Quality Control

Field QA/QC samples were collected during the surface water and sediment investigation at Site 44, including duplicate samples, equipment rinsate samples, and trip blanks. Table 3-12 provides a summary of the QA/QC sampling program conducted during the surface water and sediment investigation. Section 3.2.5 lists the various QA/QC samples collected during the sampling program at Site 44 and the frequency at which they were obtained.

3.5 Ecological Investigation

An ecological investigation, consisting of a habitat evaluation and a bioassay study, was conducted at Site 44. During the habitat evaluation, dominant vegetation types and species were identified in the field; those plants that could not be readily identified were collected for further examination in the office. Amphibians, reptiles, birds, and mammals were also identified as visual sightings or evidence allowed. In many cases, the animals themselves were not seen, but scat, tracks, feeding areas, or remains were noted. From this information, ecological communities were established and biohabitat maps developed (refer to Section 2.0).

The bioassay study was conducted in a laboratory environment, using surface water and sediment samples that were retained from Site 44. A 7-day survival and growth study of fathead minnows was performed with each of the surface water samples. The tests were conducted with sample dilutions of 100 percent, 50 percent, 25 percent, 12.5 percent, and 6.25 percent. A control sample that consisted of 100 percent dilution water was also tested. Survival of the minnows was recorded daily and growth of the minnows (i.e., weight gain or loss) was recorded at the end of 7 days.

In addition to the surface water test, a 10-day survival and growth bioassay study was conducted using the sediments retained from Site 44. During the sediment bioassay tests, the overlying water was replaced twice daily. The sediment, however, was not replaced or diluted during the tests. A control sediment sample was also tested in order to statistically correlate sediment findings with the presence or absence of contamination. The control sample was retained from an area within MCB, Camp Lejeune that is not known or suspected to have received contamination. The survival and growth of the introduced amphipods were recorded at the end of the 10 days. Results from the bioassay study are provided in Appendix W.

3.6 Decontamination Procedures

Decontamination procedures performed in the field were initiated in accordance with USEPA Region IV SOPs. Sampling and drilling equipment were divided into two decontamination groups, heavy equipment and routine sample collection equipment. Heavy equipment included the drill rig, hollow-stem augers, and drill and sampling rods. Routine sample collection equipment included split spoons, stainless steel core barrels (used with the GeoProbe™), and stainless steel spoons and bowls, and Teflon™ tubing.

The following procedures were implemented for heavy equipment:

- Removal of caked-on soil with brush

- Steam clean with high-pressure steam
- Air dry

The following procedures were implemented for routine sample collection equipment:

- Clean with distilled water and laboratory detergent (Liquinox soap solution)
- Rinse thoroughly with distilled water
- Rinse twice with isopropol alcohol
- Air dry
- Wrap in aluminum foil, if appropriate

Temporary decontamination pads, constructed of wood and plastic, were constructed to prevent spillage of fluids onto the ground surface. Decontamination fluids generated during the field program were containerized and handled according to the procedures outlined in Section 3.8.

3.7 Investigation Derived Waste (IDW) Handling

Field investigation activities at Site 44 resulted in the generation of various IDW. This IDW included drilling mud, soil cuttings, well development and purge water, and solutions used to decontaminate non-disposable sampling equipment. The general management techniques utilized for the IDW were:

1. Collection and containerization of IDW material.
2. Temporary storage of IDW while awaiting confirmatory analytical data.
3. Final disposal of aqueous and solid IDW material.

The management of the IDW was performed in accordance with guidelines developed by the USEPA Office of Emergency and Remedial Response, Hazardous Site Control Division (USEPA, 1992). Both the IDW soils and water were returned, based on confirmatory analytical data, to their respective source areas. Contaminated wastewater was sent off site to a licensed hazardous waste disposal facility. Appendix F provides information regarding the management and disposal of the IDW.

3.8 References

American Society for Testing and Materials (ASTM). 1990a. Standard Test Method for Particle Size Analysis of Soils. ASTM D-422-63 (Reapproved 1990). American Society for Testing and Materials, Philadelphia, Pennsylvania.

American Society for Testing and Materials (ASTM). 1990b. Test Method for Hydraulic Conductivity of Saturated Porous Materials Using a Flexible Wall Permeameter. ASTM D-5084-90. American Society for Testing and Materials, Philadelphia, Pennsylvania.

American Society for Testing and Materials (ASTM). 1993a. Standard Practice for Description and Identification of Soils (Visual Manual Procedure). ASTM D-2488-93. American Society for Testing and Materials, Philadelphia, Pennsylvania.

American Society for Testing and Materials (ASTM). 1993b. Standard Test Method for Liquid Limit, Plastic Limit, and Plasticity Index of Soils. ASTM D-4418-93. American Society for Testing and Materials, Philadelphia, Pennsylvania.

American Society for Testing and Materials (ASTM). 1994. Standard Practice for Thin-Walled Tube Geotechnical Sampling of Soils. ASTM D-1587-94. American Society for Testing and Materials, Philadelphia, Pennsylvania.

Baker Environmental, Inc. 1994a. Site Inspection Report - Site 43, Agan Street Dump. Final. Prepared for the Department of the Navy, Naval Facilities Engineering Command, Atlantic Division, Norfolk, Virginia. January 1994.

Baker Environmental, Inc. 1994b. Remedial Investigation/Feasibility Study Work Plan for Operable Unit No. 6 (Sites 43, 43, 44, 54, and 86), Marine Corps Base Camp Lejeune, North Carolina. Final. Prepared for the Department of the Navy, Naval Facilities Engineering Command, Atlantic Division, Norfolk, Virginia. December 1994.

Naval Energy and Environmental Support Activity (NEESA). 1988. Sampling and Chemical Analysis Quality Assurance Requirements for the Navy Installation Restoration Program. Department of the Navy, Naval Energy and Environmental Support Activity, Port Hueneme, California. NEESA 20.2-047B.

United States Environmental Protection Agency (USEPA). 1991. National Functional Guidelines for Organic Data Review. Draft. USEPA Contract Laboratory Program. June 1991.

United States Environmental Protection Agency (USEPA). 1992. Guide to Management of Investigation-Derived Wastes. Office of Emergency and Remedial Response Hazardous Site Control Division. Washington, D.C. OS-220W. April 1992.

Water and Air Research, Inc. (WAR). 1983. Initial Assessment Study of Marine Corps Base Camp Lejeune, North Carolina. Prepared for the Department of the Navy, Naval Energy and Environmental Support Activity, Port Hueneme, California. April 1983.

SECTION 3.0 TABLES

TABLE 3-1

**SOIL SAMPLING SUMMARY
TEST BORINGS
SITE 44, JONES STREET DUMP
REMEDIAL INVESTIGATION, CTO-0303
MCAS, NEW RIVER, NORTH CAROLINA**

Sample Location	Depth of Borehole (feet, below ground surface)	Sampling Interval (feet, below ground surface)	Analytical Parameters					
			TCL Pest/PCB	TAL Metals	TCL VOC	TCL SVOC	Duplicate Sample	MS/MSD
44-OA-SB01	11	0-1	X	X	X	X		
		7-9	X	X	X	X		
44-OA-SB02	9	0-1	X	X	X	X		
		5-7	X	X	X	X		
44-OA-SB03	5	0-1	X	X	X	X		
		1-3	X	X	X	X		
44-OA-SB04	7	0-1	X	X	X	X		
		3-5	X	X	X	X		X
44-OA-SB05	5	0-1	X	X	X	X		
		3-5	X	X	X	X		
44-OA-SB06	7	0-1	X	X	X	X		
		3-5	X	X	X	X		
44-WA-SB01	9	0-1	X	X	X	X	X	X
		5-7	X	X	X	X		
44-WA-SB02	7	0-1	X	X	X	X		
		5-7	X	X	X	X		
44-WA-SB03	9	0-1	X	X	X	X		
		5-7	X	X	X	X		
44-WA-SB04	9	0-1	X	X	X	X		
		5-7	X	X	X	X		
44-BB-SB01 ⁽¹⁾	9	0-1	X	X	X	X		
		5-7	X	X	X	X		
44-BB-SB02 ⁽¹⁾	3	0-1	X	X	X	X		
		1-3	X	X	X	X		

Notes:

⁽¹⁾ Background or control sample location.

TABLE 3-2

**SOIL SAMPLING SUMMARY
 MONITORING WELL TEST BORINGS
 SITE 44, JONES STREET DUMP
 REMEDIAL INVESTIGATION, CTO-0303
 MCAS, NEW RIVER, NORTH CAROLINA**

Sample Location	Depth of Borehole (feet, below ground surface)	Sampling Interval (feet, below ground surface)	Analytical Parameters					
			TCL Pest/PCB	TAL Metals	TCL VOC	TCL SVOC	Duplicate Sample	MS/MSD
44-GW01DW	9	0-1	X	X	X	X		
		5-7	X	X	X	X		
44-GW04	11	0-1	X	X	X	X		
		7-9	X	X	X	X		
44-GW05	9	0-1	X	X	X	X	X	X
		5-7	X	X	X	X		

TABLE 3-3

**SOIL SAMPLING SUMMARY
TEST PIT EXCAVATION
SITE 44, JONES STREET DUMP
REMEDIAL INVESTIGATION, CTO-0303
MCAS, NEW RIVER, NORTH CAROLINA**

Sample Location	Depth/ Length of Excavation (feet)	Sampling Interval (feet, below ground surface)	Analytical Parameters					
			TCL Pest/PCB	TAL Metals	TCL VOC	TCL SVOC	Duplicate Sample	MS/MSD
44-TP03	6/25	0-4	X	X	X	X		

Notes:

RCRA - Resource Conservation and Recovery Act
Hazardous Waste Characteristics

TCLP - Full Toxicity Characteristic Leaching Procedure Analysis (Volatiles, Semivolatiles, Pesticides, PCBs, and Metals).

TABLE 3-4

QUALITY ASSURANCE/QUALITY CONTROL SAMPLING PROGRAM
SOIL INVESTIGATION
SITE 44, JONES STREET DUMP
REMEDIAL INVESTIGATION, CTO-0303
MCAS, NEW RIVER, NORTH CAROLINA

QA/QC Sample ⁽¹⁾	Frequency of Collection	Number of Samples	Analytical Parameters
Trip Blanks ⁽²⁾	One per cooler	2	TCL Volatiles
Field Duplicates ⁽³⁾	10% of sample frequency	3	TCL VOA, TCL SVOA, TCL PEST/PCB, TAL Metals

Notes:

- ⁽¹⁾ QA/QC sample types defined in Section 3.2.5 in text.
- ⁽²⁾ Trip blanks submitted with coolers which contained samples for volatile analysis. Samples analyzed for TCL Volatiles only.
- ⁽³⁾ Field duplicate samples presented in Appendix J.

TABLE 3-5

**SUMMARY OF WELL CONSTRUCTION DETAILS
SITE 44, JONES STREET DUMP
REMEDIAL INVESTIGATION, CTO-0303
MCAS, NEW RIVER, NORTH CAROLINA**

Well No.	Date Installed	Top of PVC Casing Elevation (feet, above msl) ⁽¹⁾	Ground Surface Elevation (feet, above msl)	Boring Depth (feet, below ground surface)	Well Depth (feet, below ground surface)	Screen Interval Depth (feet, below ground surface)	Sand Pack Interval Depth (feet, below ground surface)	Bentonite Interval Depth (feet, below ground surface)
44-GW01DW	3/22/95	13.89	11.74	86	70	65-70	62-71	57-62
44-GW04	3/22/95	17.55	15.78	23	22	7-22	5-23	1-5
44-GW05	3/23/95	14.26	12.55	22	21	6-21	4-22	2-4
44-GW06	3/21/95	13.13	11.10	19	18	3-18	2-19	0-2
44-GW06DW	2/27/95	13.29	11.20	76	75	70-75	66.5-76	63-66.5

Notes:

⁽¹⁾ msl = mean sea level

Horizontal positions are referenced to N.C. State Plane Coordinate System (NAD 27) CF = 0.9999216 from USMC Monument Toney.

Vertical datum NGVD 29.

TABLE 3-6

SUMMARY OF WATER LEVEL MEASUREMENTS
 SITE 44, JONES STREET DUMP
 REMEDIAL INVESTIGATION, CTO-0303
 MCAS, NEW RIVER, NORTH CAROLINA

Well No.	Top of PVC Casing Elevation (feet, above msl) ⁽¹⁾	Depth to Groundwater (feet, below top of casing) March 26, 1995	Depth to Groundwater (feet, below top of casing) April 10, 1995	Depth to Groundwater (feet, below top of casing) May 6, 1995	Groundwater Elevation (feet, above msl) March 26, 1995	Groundwater Elevation (feet, above msl) April 10, 1995	Groundwater Elevation (feet, above msl) May 10, 1995
44-GW01	14.68	8.48	9.15	10.17	6.20	5.53	4.51
44-GW01DW ⁽²⁾	13.89	7.58	8.11	9.00	6.31	5.78	4.89
44-GW02	12.90	6.95	7.63	8.67	5.95	5.27	4.23
44-GW03	17.34	10.45	11.12	11.99	6.89	6.22	5.35
44-GW04	17.55	11.03	11.61	12.50	6.52	5.94	5.05
44-GW05	14.26	8.79	9.28	10.03	5.47	4.98	4.23
44-GW06	13.13	4.66	5.49	6.74	8.47	7.64	6.39
44-GW06DW ⁽²⁾	13.29	4.71	5.29	6.21	8.58	8.00	7.08
44-SG01 ⁽³⁾	4.08	NA	NA	1.10	NA	NA	2.98
44-SG02 ⁽³⁾	2.91	NA	NA	1.10	NA	NA	1.81
44-SG03 ⁽³⁾	2.57	NA	NA	1.22	NA	NA	1.35
44-SG04 ⁽³⁾	2.82	NA	NA	1.60	NA	NA	1.22

Notes:

- ⁽¹⁾ msl = mean sea level
- ⁽²⁾ Deep monitoring well
- ⁽³⁾ Staff gauge
- NA - Not applicable

TABLE 3-7

SUMMARY OF GROUNDWATER FIELD PARAMETERS
 SITE 44, JONES STREET DUMP
 REMEDIAL INVESTIGATION, CTO-0303
 MCAS, NEW RIVER, NORTH CAROLINA

Well No.	Depth of Well (ft.)	Purge Volume (gals.)	Field Parameters				
Date of Measurement			Well Volume	Specific Conductance at 25°C (micromhos/cm)	Temperature (°C)	pH (S.U.)	Turbidity (T.U.)
44-GW01	18.07	4.35	1.0	672.0	19.0	6.10	2.5
4/9/95			2.0	690.0	18.0	6.00	1.6
			3.0	690.0	18.0	6.15	1.3
44-GW01DW	71.6	30.51	0.5	708.0	17.0	7.22	31.0
4/9/95			1.0	708.0	17.0	7.46	19.9
			1.5	708.0	17.0	7.55	17.2
			2.0	708.0	17.0	7.59	7.1
			2.5	690.0	18.0	7.45	4.6
			3.0	672.0	19.0	7.56	4.0
			44-GW02	15.05	30.94	1.0	NA
4/10/95	2.0	60.0	16.0			5.16	174.5
	3.0	55.0	15.0			5.24	126.9
	4.0	55.0	15.0			5.24	115.2
	5.0	55.0	15.0			5.24	108.9
	6.0	56.0	14.5			5.28	93.8
	7.0	55.0	15.0			5.27	75.4
	8.0	55.0	15.0			5.25	72.2
	9.0	55.0	15.0			5.24	67.8
	11.0	55.0	15.0			5.26	60.7
	13.0	55.0	15.0			5.25	54.1
	15.0	54.0	16.0			5.24	51.2
	17.0	54.0	16.0			5.23	47.0
	20.0	54.0	16.0			5.23	44.7
	23.0	54.0	16.0			5.22	41.3
26.0	54.0	16.0	5.21	39.5			
44-GW03	17.01	2.85	1.0	720.0	16.0	6.36	4.9
4/10/95			2.0	732.0	15.5	6.40	3.2
			3.0	738.0	15.0	6.42	2.6

TABLE 3-7 (Continued)

SUMMARY OF GROUNDWATER FIELD PARAMETERS
 SITE 44, JONES STREET DUMP
 REMEDIAL INVESTIGATION, CTO-0303
 MCB, NEW RIVER, NORTH CAROLINA

Well No.	Depth of Well (ft.)	Purge Volume (gals.)	Field Parameters				
Date of Measurement			Well Volume	Specific Conductance at 25°C (micromhos/cm)	Temperature (°C)	pH (S.U.)	Turbidity (T.U.)
44-GW04	24.26	8.16	0.5	437.0	18.0	6.04	107.8
4/8/95			1.0	531.0	17.0	5.98	40.0
			1.5	554.0	17.0	6.35	27.0
			2.0	590.0	17.0	3.39	28.9
			2.5	632.0	18.0	6.41	26.1
			3.0	649.0	17.0	6.39	20.7
			3.5	632.0	18.0	6.06	10.7
			4.0	690.0	18.0	6.48	10.2
44-GW05	23.22	15.68	1.0	424.0	17.0	6.31	9.6
4/9/95			2.0	318.0	17.0	6.25	22.1
			3.0	306.0	17.0	6.26	22.9
			4.0	276.0	18.0	6.17	19.6
			5.0	264.0	18.0	6.12	20.5
			6.0	253.0	18.0	5.83	4.5
			7.0	241.0	18.0	6.14	3.0
44-GW06	20.02	6.96	0.5	275.0	14.0	5.75	3.3
4/8/95			1.0	256.0	14.5	5.65	2.3
			1.5	250.0	14.5	5.55	1.0
			2.0	237.0	14.5	5.47	0.8
			2.5	237.0	14.5	5.42	0.7
			3.0	237.0	14.5	5.40	0.6
44-GW-06DW	75.0	33.54	0.25	480.0	16.0	7.57	0.7
4/8/95			0.50	472.0	17.0	7.24	4.37
			0.75	483.0	17.0	7.59	3.20
			1.00	483.0	17.0	7.27	3.00
			1.25	489.0	17.0	7.58	2.58
			1.50	507.0	17.0	7.05	1.87
			1.75	507.0	17.0	7.56	1.5
			2.00	507.0	17.0	7.40	1.4
			2.25	507.0	17.0	7.35	1.1
			2.50	507.0	17.0	7.56	0.9
			2.75	507.0	17.0	7.55	0.7
			3.00	507.0	17.0	7.52	0.7

TABLE 3-7 (Continued)

SUMMARY OF GROUNDWATER FIELD PARAMETERS
 SITE 44, JONES STREET DUMP
 REMEDIAL INVESTIGATION, CTO-0303
 MCB, NEW RIVER, NORTH CAROLINA

Well No.	Depth of Well (ft.)	Purge Volume (gals.)	Field Parameters				
Date of Measurement			Well Volume	Specific Conductance at 25°C (micromhos/cm)	Temperature (°C)	pH (S.U.)	Turbidity (T.U.)
44-TW01	4.0	NA	NA	529.0	14.0	6.40	>200.0
4/10/95			NA	396.0	14.0	6.02	156.4
			NA	334.0	15.0	6.07	64.8
			NA	344.0	15.0	6.13	36.3
			NA	341.0	15.5	6.21	26.6
			NA	350.0	15.0	NA	8.20

Notes:

S.U. - Standard Units
 T.U. - Turbidity Units

TABLE 3-8

GROUNDWATER SAMPLING SUMMARY
 SITE 44, JONES STREET DUMP
 REMEDIAL INVESTIGATION, CTO-0303
 MCAS, NEW RIVER, NORTH CAROLINA

Sample Location	Analytical Parameters								
	TCL VOA	TCL SVOA	TCL Pest./ PCB	Total TAL Metals	Dissolved TAL Metals	TSS	TDS	Duplicate Sample	MS/MSD
44-TW01	X	X	X	X		X	X		
44-GW01	X	X	X	X	X	X	X	X	X
44-GW01DW	X	X	X	X		X	X		
44-GW02	X	X	X	X		X	X		
44-GW03	X	X	X	X		X	X		
44-GW04	X	X	X	X		X	X		
44-GW05	X	X	X	X		X	X		
44-GW06	X	X	X	X		X	X		
44-GW06DW	X	X	X	X		X	X		

Notes:

TDS - Total Dissolved Solids
 TSS - Total Suspended Solids

TABLE 3-9

QUALITY ASSURANCE/QUALITY CONTROL SAMPLING PROGRAM
 GROUNDWATER INVESTIGATION
 SITE 44, JONES STREET DUMP
 REMEDIAL INVESTIGATION, CTO-0303
 MCAS, NEW RIVER, NORTH CAROLINA

QA/QC Sample ⁽¹⁾	Frequency of Collection	Number of Samples	Analytical Parameters
Trip Blanks ⁽²⁾	One per cooler	2	TCL Volatiles
Equipment ⁽³⁾	One per day	2	TCL VOA, TCL SVOA, TCL PEST/PCB, TAL Metals, Dissolved TAL Metals
Field Duplicates ⁽⁴⁾	10% of sample frequency	1	TCL VOA, TCL SVOA, TCL PEST/PCB, TAL Metals, Dissolved TAL Metals, TSS, & TDS

Notes:

- (1) QA/QC sample types defined in Section 3.2.5 in text.
- (2) Trip blanks submitted with coolers which contained samples for volatile analysis. Samples analyzed for TCL Volatiles only.
- (3) Equipment rinsates collected from various sampling equipment (e.g., peristaltic pump).
- (4) Field duplicate samples presented in Appendix J.

TABLE 3-10

SUMMARY OF SURFACE WATER FIELD PARAMETERS
 SITE 44, JONES STREET DUMP
 REMEDIAL INVESTIGATION, CTO-0303
 MCAS, NEW RIVER, NORTH CAROLINA

Station	Temperature (°C)	pH (S.U.)	Dissolved Oxygen (mg/L)	Conductivity (umhos/cm)	Salinity (ppt)
44-EC-SW/SD01	18.1	3.58	2.9	6.84	0
44-EC-SW/SD02	16.4-18.4	6.57-7.14	2.6-6.9	350-441	0
44-EC-SW/SD03	13.0-15.8	6.92	3.0	320-354	0.1
44-EC-SW/SD04	16.0-16.5	7.08	3.2	909-950	0.8-0.9
44-EC-SW/SD05	17.7-18.5	7.16-7.32	4.3-5.1	950-5,400	0.9-4.1
44-UT-SW/SD01	16.3-16.6	6.87	3.0	425-511	0.1
44-UT-SW/SD02	15.5-15.9	6.93	8.2	509-850	0.2-1
44-UT-SW/SD03	15.5-16.5	6.78-6.93	0.7-1.7	750-2,020	0.5-2.1

Notes:

mg/L - Milligrams per Liter

S.U. - Standard Units

umhos/cm - Micromhos per centimeter

ppt - Parts Per Thousand

EC - Edwards Creek

UT - Unnamed Tributary

TABLE 3-11

**SURFACE WATER AND SEDIMENT SAMPLING SUMMARY
SITE 44, JONES STREET DUMP
REMEDIAL INVESTIGATION, CTO-0303
MCAS, NEW RIVER, NORTH CAROLINA**

Sample Location	Sample Matrix	Sample Depth ⁽¹⁾	Analytical Parameters										
			TCL VOC	TCL SVOC	TCL Pest/PCB	TAL Metals	Diss. TAL Metals	Hardness	TOC	Grain Size	Duplicate Sample	MS/MSD	
44-EC-SW/SD01	SW	NA	X	X	X	X	X	X	X				
	SD	0-6	X	X	X	X			X	X			
	SD	6-12	X	X	X	X							
44-EC-SW/SD02	SW	NA	X	X	X	X	X	X	X			X	X
	SD	0-6	X	X	X	X	X		X	X			
	SD	6-12	X	X	X	X							
44-EC-SW/SD03	SW	NA	X	X	X	X	X	X	X				
	SD	0-6	X	X	X	X					X		
	SD	6-12	X	X	X	X							
44-EC-SW/SD04	SW	NA	X	X	X	X	X	X	X				
	SD	0-6	X	X	X	X							
	SD	6-12	X	X	X	X							
44-EC-SW/SD05	SW	NA	X	X	X	X	X	X	X				
	SD	0-6	X	X	X	X							
	SD	6-12	X	X	X	X							
44-UT-SW/SD01	SW	NA	X	X	X	X	X	X	X				
	SD	0-6	X	X	X	X			X				
	SD	6-12	X	X	X	X			X		X		
44-UT-SW/SD02	SW	NA	X	X	X	X	X	X	X				
	SD	0-6	X	X	X	X							
	SD	6-12	X	X	X	X				X			

TABLE 3-11 (Continued)

**SURFACE WATER AND SEDIMENT SAMPLING SUMMARY
SITE 44, JONES STREET DUMP
REMEDIAL INVESTIGATION, CTO-0303
MCAS, NEW RIVER, NORTH CAROLINA**

Sample Location	Sample Matrix	Sample Depth ⁽¹⁾	Analytical Parameters									
			TCL VOC	TCL SVOC	TCL Pest/PCB	TAL Metals	Diss. TAL Metals	Hardness	TOC	Grain Size	Duplicate Sample	MS/MSD
44-UT-SW/SD03	SW	NA	X	X	X	X	X	X				
	SD	0-6	X	X	X	X						
	SD	6-12	X	X	X	X						

Notes:

- ⁽¹⁾ NA - Not applicable for surface water samples
- SW - Surface Water
- SD - Sediment
- TOC - Total Organic Carbon

TABLE 3-12

QUALITY ASSURANCE/QUALITY CONTROL SAMPLING PROGRAM
 SURFACE WATER AND SEDIMENT INVESTIGATION
 SITE 44, JONES STREET DUMP
 REMEDIAL INVESTIGATION, CTO-0303
 MCAS, NEW RIVER, NORTH CAROLINA

QA/QC Sample ⁽¹⁾	Frequency of Collection	Number of Samples	Analytical Parameters
Trip Blanks ⁽²⁾	One per cooler	2	TCL Volatiles
Equipment ⁽³⁾	One per day	1	TCL VOA, TCL SVOA, TCL PEST/PCB, TAL Metals
Field Duplicates ⁽⁴⁾	10% of sample frequency	3	TCL VOA, TCL SVOA, TCL PEST/PCB, TAL Metals, TOC

- Notes: (1) QA/QC sample types defined in Section 3.1.5 in text.
 (2) Trip blanks submitted with coolers which contained samples for volatile analysis. Samples analyzed for TCL Volatiles only.
 (3) Equipment rinsates collected from various sampling equipment.
 (4) Field duplicate samples presented in Appendix J.

SECTION 3.0 FIGURES

LEGEND

- 44-GW04 SOIL TEST BORING FOR SHALLOW MONITORING WELL
- 44-GW01DW SOIL TEST BORING FOR DEEP MONITORING WELL
- OA-SB02 SOIL BORING LOCATION
- TP01 EXPLORATORY TEST PIT
- FLOW DIRECTION OF SURFACE WATER FLOW
- MARSH MARSH
- EDGE OVERHEAD ELECTRIC LINE & UTILITY POLE
- FENCE FENCE
- ASPHALT ROAD ASPHALT ROAD
- GRAVEL OR DIRT ROAD GRAVEL OR DIRT ROAD
- EDGE OF CREEK, DRAINAGE DITCH, MARSH OR POND EDGE OF CREEK, DRAINAGE DITCH, MARSH OR POND
- TREE LINE TREE LINE
- HSE BASE HOUSING UNIT

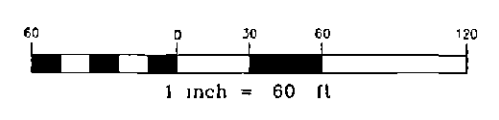
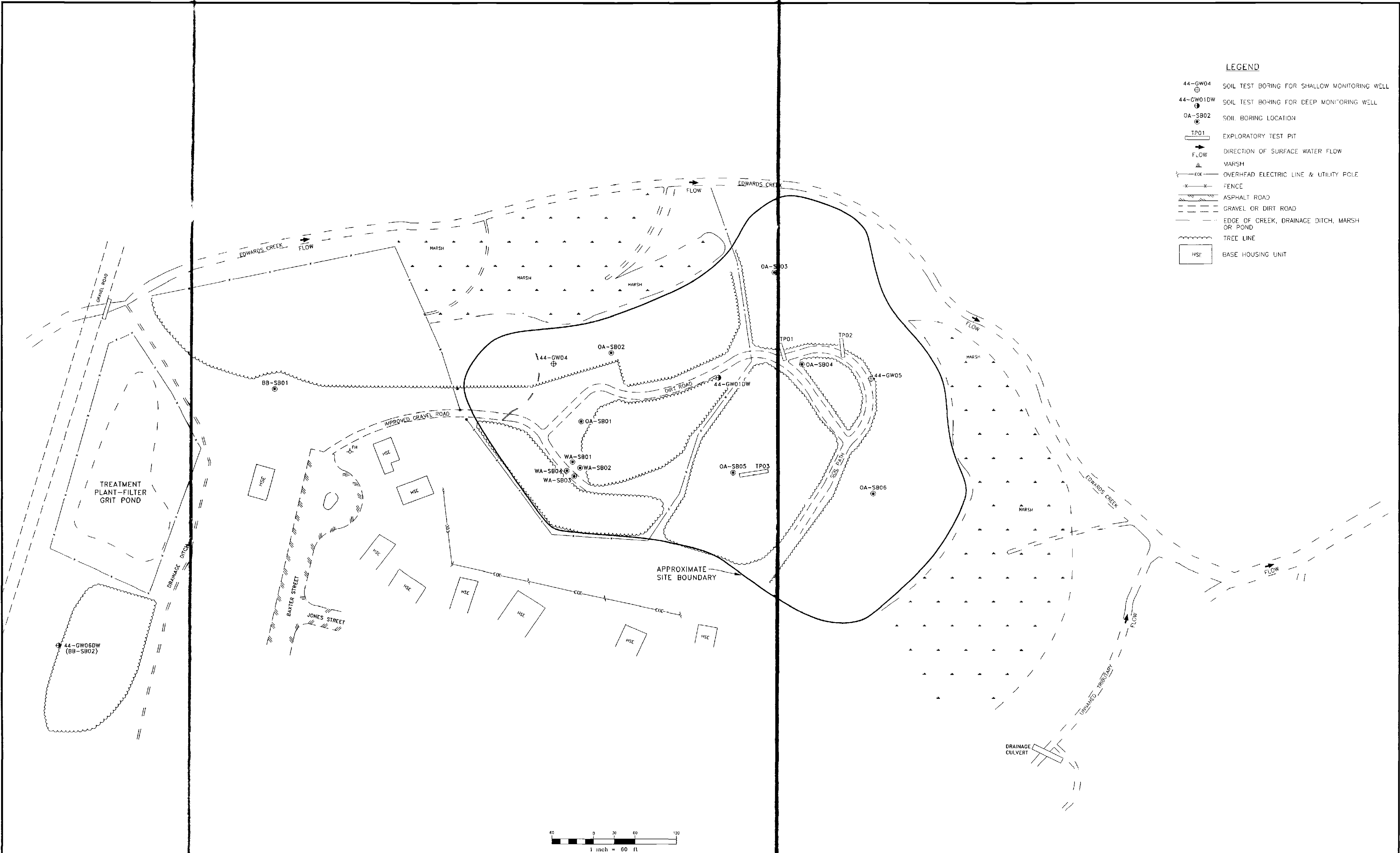

REVISIONS	

DRAWN	REL
REVIEWED	TFT/JEZ
S O #	62470-303
CADD#	303027RI

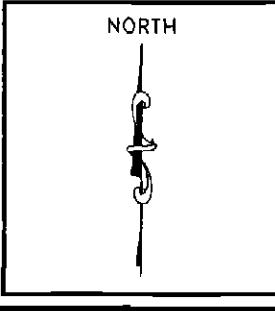

REMEDIAL INVESTIGATION CTO-0303
 MARINE CORPS AIR STATION, NEW RIVER
 NORTH CAROLINA

 BAKER ENVIRONMENTAL, Inc.
 Coraopolis, Pennsylvania

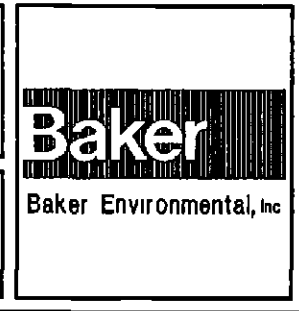

SURFACE AND SUBSURFACE SOIL SAMPLING LOCATIONS SITE 44, JONES STREET DUMP		FIGURE No 3-1	
SCALE	1" = 60'	DATE	JANUARY 1995

SOURCE LANTDIV, FEBRUARY 1992
 SURVEY BRENT A LANIER AND ASSOCIATES, 1995

01715407X

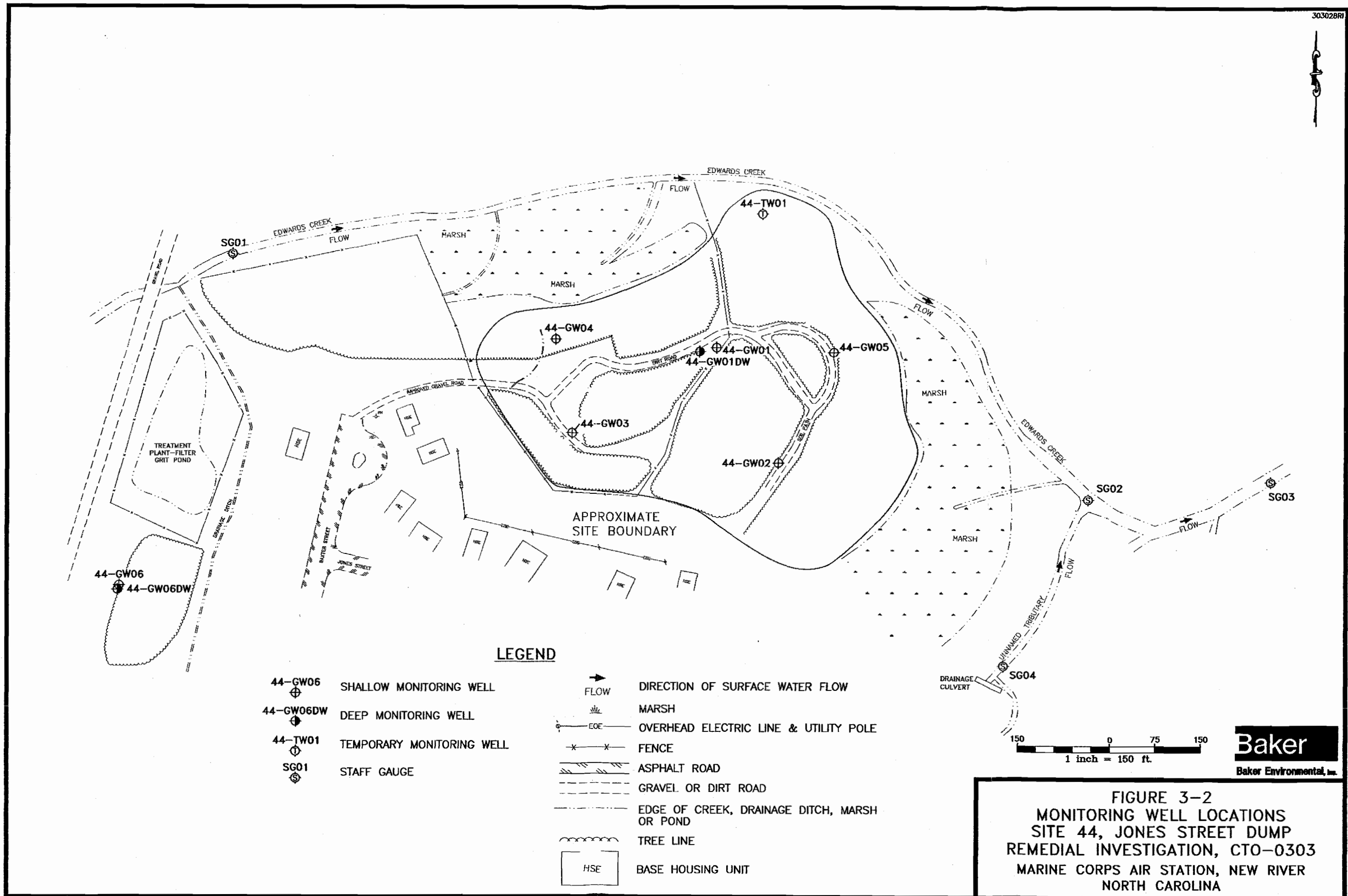
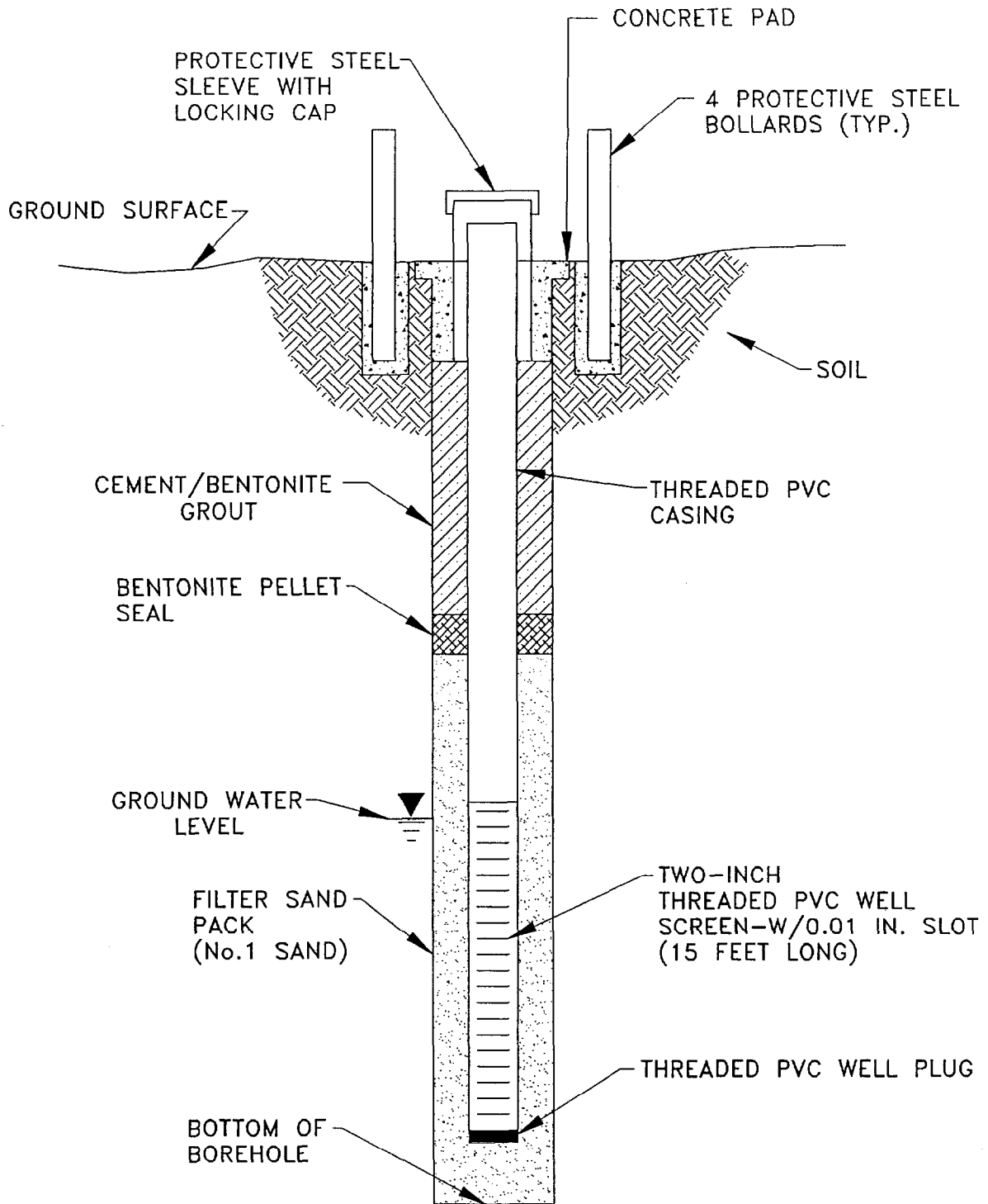

FIGURE 3-2
MONITORING WELL LOCATIONS
SITE 44, JONES STREET DUMP
REMEDIAL INVESTIGATION, CTO-0303
MARINE CORPS AIR STATION, NEW RIVER
NORTH CAROLINA



01715Y082



N.T.S.



FIGURE 3-3
TYPICAL SHALLOW TYPE II GROUNDWATER
MONITORING WELL CONSTRUCTION DIAGRAM
REMEDIAL INVESTIGATION CTO-0303

MARINE CORPS BASE, CAMP LEJEUNE
NORTH CAROLINA

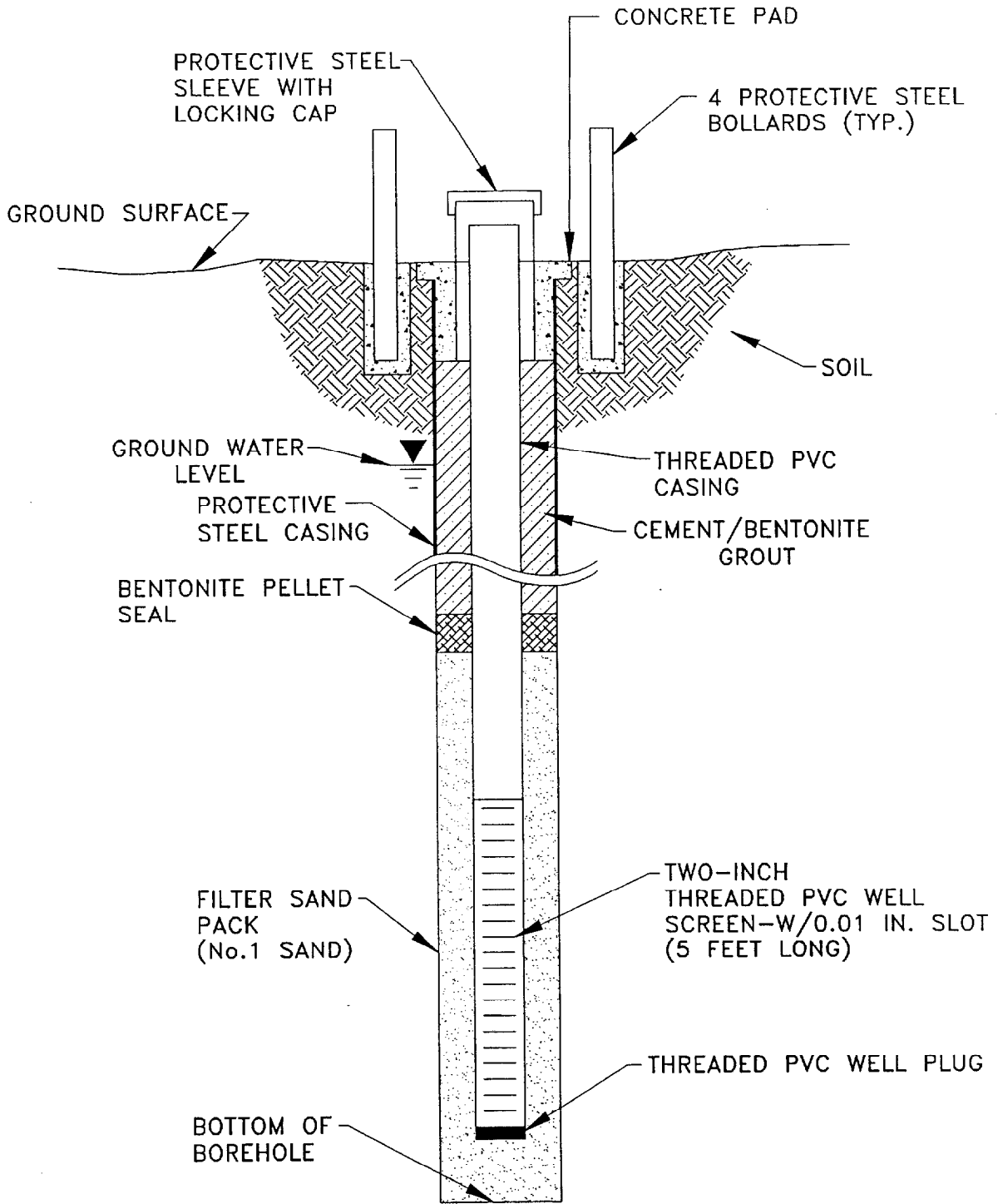

N.T.S.

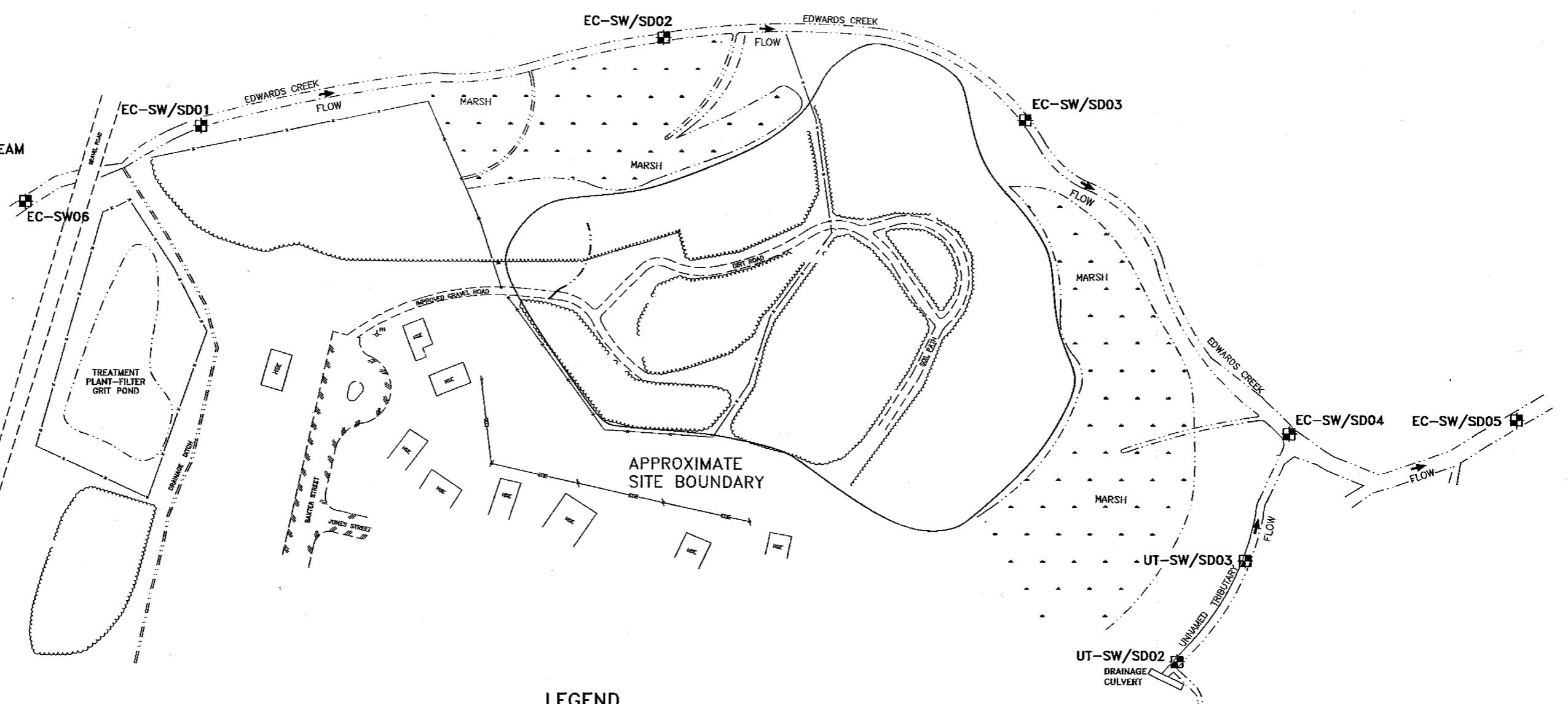

FIGURE 3-4
TYPICAL DEEP TYPE III GROUNDWATER
MONITORING WELL CONSTRUCTION DIAGRAM
REMEDIAL INVESTIGATION CTO-0303
MARINE CORPS BASE, CAMP LEJEUNE
NORTH CAROLINA

EC-SW09
1200' UPSTREAM

EC-SW08
480' UPSTREAM

EC-SW07



LEGEND

- | | | | |
|------------|--|-------------|--|
| EC-SW/SD01 | SURFACE WATER AND SEDIMENT SAMPLING LOCATION | —○— | OVERHEAD ELECTRIC LINE & UTILITY POLE |
| EC-SW06 | SURFACE WATER SAMPLING LOCATION ONLY | -x-x- | FENCE |
| → | DIRECTION OF SURFACE WATER FLOW | | ASPHALT ROAD |
| 🌿 | MARSH | - - - - - | GRAVEL OR DIRT ROAD |
| | | - · - · - · | EDGE OF CREEK, DRAINAGE DITCH, MARSH OR POND |
| | | ~~~~~ | TREE LINE |
| | | [HSE] | BASE HOUSING UNIT |

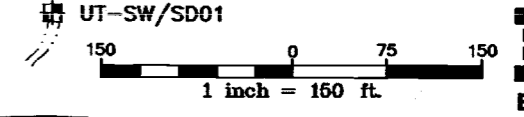

FIGURE 3-5
SURFACE WATER AND SEDIMENT
SAMPLING LOCATIONS
SITE 44, JONES STREET DUMP
REMEDIAL INVESTIGATION, CTO-0303
MARINE CORPS AIR STATION, NEW RIVER
NORTH CAROLINA

01715Y09Z

4.0 NATURE AND EXTENT OF CONTAMINATION

This section presents the nature and extent of contamination at OU No. 6, Site 44. The objective of this section is to characterize the nature and extent of any contamination which may be present as a result of past waste management activities. The characterization of contaminants at Site 44 was performed by sampling and laboratory analysis of soil, groundwater, surface water, and sediment environmental media. Appendices G through M present the Sampling Summaries; Data and Frequency Summaries; Statistical Summaries; Field Duplicate Summaries; Quality Assurance and Quality Control Summaries; TCLP, RCRA, and TPH Results; and Engineering Parameter Results for the various media at Site 44.

4.1 Data Quality

The majority of data generated during the RI was submitted for third-party validation; wet chemistry, TCLP, RCRA, grain size, and permeability results were not validated. The usability of the data was determined by the third party data validator, Heartland Environmental Services, Inc. Procedures stipulated by the National Functional Guidelines for Organic (USEPA, 1991) and Inorganic (USEPA, 1988) Analyses were observed during the validation process. Validation of the analytical data serves to reduce the inherent uncertainties associated with its usability. Data qualified as "J" were retained as estimated. Estimated analytical results within a data set are common and considered to be usable by the USEPA (USEPA, 1989). Data may be qualified as estimated for several reasons including an exceedance of holding times, high or low surrogate recovery or intra-sample variability. In addition, values may be assigned an estimated "J" qualifier if the reported value is below the Contract Required Detection Limit (CRDL) or the Contract Required Quantitation Limit (CRQL). Data assigned a rejected "R" qualifier was excluded from the usable data set. Under these conditions estimated positive results were designated with "J" qualifiers and all rejected were assigned the "R" qualifiers. Table 4-1 provides a summary of all rejected Site 44 data.

Additional qualifiers were employed during the validation of data. The "NJ" qualifier denotes that a compound was tentatively identified, but the reported value may not be accurate or precise. Compounds that were not detected and had inaccurate or imprecise quantitation limits were assigned the "UJ" qualifier.

4.1.1 Data Management and Tracking

The management and tracking of data, from time of field collection to receipt of validation report, is of primary importance to the overall quality of laboratory analytical results. Field samples and their corresponding analyses were recorded on chain-of-custody forms, provided in Appendix D. Chain-of-custody forms were compared to the Field Sampling and Analysis Plan (Baker, 1994); this comparison was used to verify that appropriate laboratory analyses had been requested. Upon receipt of laboratory analytical results, a further comparison was performed to verify that each sample received by the laboratory was analyzed for the correct parameters. Finally, the validation report was compared to the requested laboratory analyses.

The management and tracking of data was used to determine the following items:

- Identify and correct chain-of-custody discrepancies prior to laboratory analysis
- Verify the receipt of all samples by the laboratory

- Confirm that requested sample analyses and validation were performed
- Ensure the delivery of a complete data set

4.2 Non-Site Related Analytical Results

Many of the organic compounds and inorganic analytes detected in environmental media at Site 44 may be attributable to non-site related conditions or activities. Two primary sources of non-site related analytical results include laboratory contaminants and naturally-occurring inorganic species. In addition, non-site related operational activities and conditions may contribute to "on-site" contamination (e.g., pesticides). A discussion of non-site related analytical results for Site 44 is provided in the subsections which follow.

4.2.1 Laboratory Contaminants

Field blank and trip blank samples provide a measure of contamination that has been introduced into a sample set during the collection, transportation, preparation, or analysis of samples. To remove non-site related constituents from further consideration, the concentrations of chemicals detected in blanks were compared with concentrations of the same chemicals detected in environmental samples.

Common laboratory contaminants (i.e., acetone, 2-butanone, chloroform, methylene chloride, toluene, and phthalate esters) were retained for use in interpreting site conditions only when observed concentrations in any environmental sample exceeded ten times the maximum concentration detected in any blank. If the concentration of a common laboratory contaminant was less than ten times the maximum blank concentration, its presence among the data set was attributed to laboratory contamination in that particular sample (USEPA, 1989) and excluded from further evaluation. The maximum concentrations of detected common laboratory contaminants in blanks were as follows:

- | | |
|-------------------------------|------------|
| ● Acetone | 24 J µg/L |
| ● Chloroform | 13 µg/L |
| ● 2-Butanone | 32 µg/L |
| ● bis-(2-Ethylhexyl)phthalate | 280 J µg/L |

Blanks containing organic constituents that were not considered common laboratory contaminants (i.e., all other TCL compounds) were retained in the site analytical database only when observed concentrations exceeded five times the maximum concentration detected in any QA/QC blank (USEPA, 1989). All TCL compounds detected at less than five times the maximum level of contamination noted in any QA/QC blank were attributed to blank contamination and excluded from further evaluation. The maximum concentrations of all other detected blank contaminants were as follows:

- | | |
|------------------------|---------|
| ● Bromodichloromethane | 13 µg/L |
| ● Dibromochloromethane | 10 µg/L |

A limited number of environmental samples that exhibited high concentrations of tentatively identified compounds (TICs) were subjected to an additional sample preparation. Medium level sample preparation provides a corrected Contract Required Quantitation Limit (CRQL) based on the volume of sample used for analysis. The corrected CRQL produces higher detection limits than the

low level sample preparation. A comparison to laboratory blanks used in the medium level preparation was used to evaluate the relative amount of contamination within these samples.

4.2.2 Naturally-Occurring Inorganic Analytes

In order to differentiate between inorganic contamination due to site operations and naturally-occurring inorganic analytes in site media, the results of the sample analyses were compared to information regarding background conditions at MCB, Camp Lejeune. The following guidelines were used for each media:

Soil:	MCB, Camp Lejeune Background Soil Samples
Groundwater:	MCB, Camp Lejeune Background Groundwater Samples
Surface Water:	MCB, Camp Lejeune Background Surface Water Samples
Sediment:	MCB, Camp Lejeune Background Sediment Samples

The following subsections address the various comparison criteria used to evaluate soil, groundwater, surface water, and sediment analytical results from samples collected at Site 44.

4.2.2.1 Soil

In general, applicable or relevant and appropriate requirements (ARARs) are not available for specific contaminants in soil. As a result, base-specific background concentrations have been compiled from a number of locations throughout MCB, Camp Lejeune to evaluate reference levels of inorganic analytes in the surface and subsurface soil.

Typical background concentration values for inorganic analytes in soils at MCB, Camp Lejeune are presented in Appendix P. These ranges are based on analytical results of background samples collected in areas not known to have been impacted by operations or disposal activities adjacent to Sites 1, 2, 6, 7, 16, 28, 30, 35, 36, 41, 43, 44, 54, 69, 74, 78, 80, and 86 (refer to Figure 1-2 for site locations throughout MCB, Camp Lejeune). Subsequent discussions of the analytical results from samples collected during the soil investigation only consider those inorganic analytes with concentrations exceeding twice the average base-specific background concentration, as recommended by USEPA Region IV.

In general, background soil samples have been collected outside the known boundaries of those sites listed above in areas with similar soil types. According to the SCS Soil Survey, the greatest portion of MCB, Camp Lejeune is underlain by a number of similar soil units. Soils found on this portion of the coastal plain are moderately to strongly acidic in nature and are classified under the USCS as SM, SM-SP (i.e., fine sand or loamy fine sand). Section 3.0 provides the locations of background soil borings completed at Site 44 during this investigation.

4.2.2.2 Groundwater

Chemical-specific ARARs are available for evaluation of analytical results from groundwater samples. In the subsequent sections which address the analytical results of samples collected during the groundwater investigation, only those inorganic parameters with concentrations exceeding applicable state or federal regulations will be discussed.

Groundwater samples were analyzed for total inorganic parameters. In addition, a limited number of selected groundwater samples were submitted for dissolved (i.e., "filtered") inorganic analyses. Concentrations of dissolved inorganics were found to be generally lower than total inorganic concentrations, particularly for metals such as chromium, iron, lead, and manganese. A 0.45-micron filter was used in the field to remove small particles of silt and clay that would otherwise be dissolved during sample preservation, resulting in higher concentrations of inorganic analytes. The total metal analyses from unfiltered samples is considered to reflect the concentrations of inorganics in the natural lithology and inorganic analytes dissolved in the groundwater.

Higher concentrations of certain metals in unfiltered groundwater samples collected at MCB, Camp Lejeune are not considered atypical based on experience gained during other studies. The difference between the two analytical results (i.e., total and filtered) is important in terms of understanding and separating naturally-occurring elements (e.g., lead) from contamination by site operations (e.g., lead in gasoline). An evaluation report which pertains to naturally occurring metals in groundwater at MCB, Camp Lejeune is provided in Appendix P.

USEPA Region IV requires that unfiltered inorganic concentrations be used in evaluating ARARs and risk to human health and the environment. In the subsequent sections, which discuss the groundwater sample analytical results, both total and dissolved inorganics (which exceed applicable state or federal limits) will be presented and discussed for comparison purposes.

Groundwater in the MCB, Camp Lejeune area is naturally rich in iron and manganese. Iron and manganese concentrations, both for total and filtered samples, in groundwater at MCB, Camp Lejeune often exceed the North Carolina Water Quality Standards (NCWQS) of 300 and 50 µg/L, respectively. Elevated levels of iron and manganese, at concentrations above the NCWQS, were reported in samples collected from a number of base potable water supply wells which are installed at depths greater than 162 feet below ground surface (Greenhorne and O'Mara, 1992). Iron and manganese concentrations from several wells at Site 44 exceeded the NCWQS but fell within the range of concentrations for samples collected elsewhere at MCB, Camp Lejeune. There is no record of any historical use of iron or manganese at Site 44. In light of this, it is assumed that iron and manganese are naturally-occurring inorganic analytes in groundwater, and their presence is not attributable to site operations.

4.2.2.3 Surface Water

In the sections which address the analytical results of samples collected during the surface water investigation, only those inorganic parameters with concentrations exceeding applicable state or federal regulatory limits will be discussed. Base-specific background concentrations have been compiled from a number of locations throughout MCB, Camp Lejeune to supplement the evaluation of detected inorganic analytes in surface water. Typical inorganic background concentration values for surface waters at MCB, Camp Lejeune are presented in Appendix P. These values are based on analytical results of background samples collected upgradient of areas known or suspected to have been impacted by operations or disposal activities. Inorganic parameters detected below these levels are assumed to be naturally-occurring elements.

4.2.2.4 Sediment

Base-specific inorganic background concentrations have been compiled from a number of locations throughout MCB, Camp Lejeune to supplement the evaluation of detected inorganic analytes in

sediment. Those inorganic analytes that exceed applicable state or federal regulatory limits are compared to base-specific background concentrations in subsequent sections. Typical inorganic background concentration values for sediments at MCB, Camp Lejeune are presented in Appendix P. These values are based on analytical results of background samples collected upgradient of areas known or suspected to have been impacted by operations or disposal activities. Inorganic parameters detected below these levels are assumed to be naturally-occurring elements.

4.3 Analytical Results

This section presents the results of the soil, groundwater, surface water, and sediment investigations performed at Site 44. A summary of site contamination, by media, is provided in Table 4-2.

4.3.1 Soil Investigation

Unique sample notations were employed to identify soil sampling locations and sample depths at Site 44. Samples designated by "WA" and "OA" were collected from specific portions of the site (as described in Section 3.0). Samples designated with the prefix "GW" were collected from monitoring well pilot test borings. The suffix "DW" after the monitoring well number indicates that the sample was obtained from a deep monitoring well test boring. The following suffix designations refer to the depth at which a sample was obtained:

- 00 - ground surface to 12 inches bgs
- 01 - 1 to 3 feet bgs
- 02 - 3 to 5 feet bgs
- 03 - 5 to 7 feet bgs
- 04 - 7 to 9 feet bgs
- 05 - 9 to 11 feet bgs

Surface soil positive detection summaries for organic compounds and inorganic analytes are presented in Tables 4-3 and 4-4. A positive detection summary of organic compounds in subsurface soil is presented in Table 4-5; a summary of inorganic analytes is provided in Table 4-6. The majority of soil samples collected at Site 44 were analyzed for full TCL organics and TAL inorganics using CLP protocols and Level IV data quality (refer to Section 3.0). Soil samples obtained from monitoring well test borings were also analyzed for full TCL organics and TAL inorganics.

4.3.1.1 Surface Soil

A total of 13 surface soil samples were collected at Site 44; each of the samples were analyzed for full TCL organics and TAL inorganics. As indicated in Table 4-2, only semivolatile and pesticide organic compounds were detected in surface soils at Site 44.

Four semivolatile compounds were detected in 4 of the 13 surface soil samples that were submitted for laboratory analyses. Semivolatile concentrations ranged from 57 µg/kg of benzo(g,h,i)perylene to 550 µg/kg of bis(2-chloroethyl)ether. As presented in Table 4-2, two of the four SVOCs were polynuclear aromatic hydrocarbon (PAH) compounds. The four borings with positive semivolatile detections were located in separate portions of the study area.

The pesticides 4,4'-DDE, 4,4'-DDD, and 4,4'-DDT were detected in surface soil samples that were submitted for analysis from Site 44. Detectable concentrations of organic pesticide compounds were identified in 4 of the 13 surface soil samples. Three of the four surface samples with pesticide compounds also had positive SVOC detections. As indicated in Table 4-2, the compounds 4,4'-DDE and 4,4'-DDT were each detected four times among surface soil samples. Pesticide concentrations ranged from 4.6 µg/kg of 4,4'-DDT to 140 µg/kg of 4,4'-DDE. 4,4'-DDD was detected once at a concentration of 7.4 µg/kg at sample station OA-SB03.

Seventeen of 23 TAL inorganics were detected among the 13 surface soil samples obtained from Site 44 (antimony, beryllium, cadmium, mercury, silver, and thallium were not detected). Table 4-2 provides a summary of the priority pollutant metals found within soil samples at Site 44. Priority pollutant metals are a subset of TAL metals that include antimony, arsenic, beryllium, cadmium, chromium, copper, lead, mercury, nickel, selenium, silver, thallium, and zinc. Arsenic, chromium, and manganese were each detected at concentrations exceeding twice the average base-specific background levels among 11 of the 13 surface soil samples. Both copper and zinc were detected at concentrations greater than one order of magnitude above the appropriate base-specific background level in sample OA-SB03 (refer to Appendix P for base-specific inorganic background concentrations). Lead and manganese were also detected at their respective maximum concentrations in sample OA-SB03.

4.3.1.2 Subsurface Soil

A total of 13 subsurface (i.e., greater than one-foot below ground surface) soil samples from Site 44 were submitted for laboratory analyses; each sample was analyzed for full TCL organics and TAL inorganics. No volatile or PCB compounds were detected among the 13 samples obtained from Site 44.

Semivolatile compounds were detected among 3 of the 13 subsurface soil samples (refer to Table 4-2). Only two SVOCs were detected, indeno(1,2,3-cd)pyrene and benzo(g,h,i)perylene. Both compounds were detected at maximum concentrations in a sample obtained from OA-SB05. In all, SVOC detections ranged from 40 to 130 µg/kg.

Three pesticide compounds were detected in subsurface soils at Site 44. A total of four subsurface samples had detectable concentrations of organic pesticides. The pesticide 4,4'-DDT was detected once among the 13 subsurface samples; 4,4'-DDE and 4,4'-DDD were each detected four times. As presented in Table 4-2, pesticide concentrations ranged from 3.2 µg/kg of 4,4'-DDE to 2,500 µg/kg of 4,4'-DDD in sample 44-GW01DW. Concentrations of the three organic pesticides were highest in a sample obtained from monitoring well test boring 44-GW01DW.

Fifteen of 23 TAL inorganics were detected in subsurface soils at Site 44 (antimony, beryllium, cadmium, cobalt, mercury, selenium, silver, and thallium were not detected). As presented in Table 4-2, arsenic, copper, lead, manganese, nickel, and zinc were each detected at concentrations which exceeded twice their average base-specific background concentration. However, none of the analytes were detected at concentrations greater than one order of magnitude above their respective base-specific background levels for subsurface soil (refer to Appendix P).

4.3.1.3 Summary

A total of four semivolatile contaminants, including two PAH compounds, were identified during the soil investigation at Site 44. The two PAH compounds were identified in both surface and subsurface soil samples. As provided in Table 4-2, each of the semivolatile compounds were detected at concentrations less than 550 µg/kg.

The pesticides 4,4'-DDE, 4,4'-DDD, and 4,4'-DDT appear to be the most widely distributed compounds in soil at Site 44. Each of the observed pesticides were detected in at least 5 of the 26 soil samples. The pesticide 4,4'-DDE was the most prevalent, with eight positive detections ranging from 3.2 to 370 µg/kg. The highest pesticide concentration was that of 4,4'-DDD at 2,500 µg/kg. In general, slightly higher concentrations of pesticides were observed in samples obtained from the central portion of the study area, particularly in samples 44-GW01DW and OA-SB05.

Inorganic analytes were detected in both surface and subsurface soil samples throughout the study area. Arsenic, chromium, and manganese were each detected above twice their average base-specific background levels in 11 of the 13 surface soil samples. Both copper and zinc were detected at concentrations in excess of ten times the average base-specific background level in a surface sample obtained from station OA-SB03. In general, however, inorganic analytes in subsurface soils were detected at concentrations within base-specific background levels.

4.3.2 **Groundwater Investigation**

The groundwater investigation at Site 44 entailed the collection of samples from three existing shallow wells (44-GW01, 44-GW02, and 44-GW03), three newly installed shallow wells (44-GW04, 44-GW05, and 44-GW06), one temporary well (44-TW01), and two newly installed deep wells (44-GW01DW and 44-GW06DW). Each of the groundwater samples collected at Site 44 were analyzed for full TCL organics and TAL total metals using CLP protocols and Level IV data quality. In addition, one of the groundwater samples was submitted for dissolved TAL metal analyses. (Dissolved or filtered TAL inorganic results are presented in this report for comparative purposes only. These results were not used to evaluate site-related risks or to determine compliance with groundwater standards.)

Analytical results from the groundwater investigation at Site 44 are provided in subsections which follow. A positive detection summary of organic compounds is provided in Table 4-7. Total and dissolved metal results are presented in Tables 4-8 and 4-9.

4.3.2.1 Shallow Groundwater

Groundwater conditions within the upper portion of the surficial aquifer were evaluated through collection and analysis of samples from both shallow and temporary monitoring wells (refer to Section 3.0 and Appendix B for well construction details).

A total of seven shallow groundwater samples from Site 44 were submitted for laboratory analysis. As indicated in Table 4-2, the detections of volatiles was limited to one of the existing shallow monitoring wells and the temporary monitoring well. Total 1,2-dichloroethene and trichloroethene were detected in the sample obtained from temporary well 44-TW01 at concentrations of 15 and 1 µg/L, respectively. Vinyl chloride was detected at a concentration of 10 µg/L, which exceeded the NCWQS of 0.015 µg/L. Tetrachloroethene was detected at a concentration of 1 µg/L in existing

well 44-GW03, which exceeded the 0.7 µg/L water quality standard. No other VOCs were detected among the seven groundwater samples submitted for analyses from the shallow aquifer; nor were pesticide and PCB contaminants detected.

Seven semivolatile compounds were detected in the groundwater sample obtained from existing well 44-GW03; the same monitoring well that exhibited tetrachloroethene contamination. Four of the seven semivolatiles detected were PAH compounds. Semivolatile concentrations ranged from 4 µg/L of 2-methylnaphthalene and carbazole to 71 µg/L of naphthalene. Acenaphthene, dibenzofuran, fluorene, and phenanthrene were also detected in the same groundwater sample.

TAL total metals were detected in each of the temporary and shallow monitoring wells at Site 44. Dissolved metals were also detected the groundwater sample submitted for filtered analysis. Complete positive detection summaries for total and dissolved metals are provided in Tables 4-8 and 4-9. Fourteen of the 23 TAL total metals were detected within at least one groundwater sample at Site 44 (antimony, beryllium, cadmium, chromium, cobalt, copper, mercury, silver, and thallium). Only seven of 23 TAL dissolved metals were detected within the one groundwater sample submitted for analysis. Iron and manganese were detected with the greatest frequency among groundwater samples and at concentrations in excess of NCWQS levels, as depicted in Table 4-2. Iron exceeded the NCWQS of 300 µg/L in each of the seven shallow groundwater samples, with a maximum concentration of 72,900 µg/L. Manganese was detected at concentrations exceeding the NCWQS of 50 µg/L in groundwater samples from four of the seven monitoring wells, with a maximum concentration of 241 µg/L.

4.3.2.2 Deep Groundwater

Two groundwater samples were obtained from the deep aquifer at Site 44; one from an upgradient location and the other from the central portion of the study area. Deep monitoring wells were screened at intervals just below a semi-confining unit, into the upper portion of the Castle Hayne aquifer. Volatile, semivolatile, pesticide, and PCB organic compounds were not detected in either of the samples obtained from the deep aquifer.

TAL total metals were detected in both of the deep monitoring wells at Site 44. Six of the 23 TAL total metals were detected in both of the deep groundwater samples. Neither of the deep aquifer samples were submitted for dissolved metal analyses. Manganese was detected in well 44-GW01DW at a concentration of 60.6 µg/L that exceeded the NCWQS of 50 µg/L. Iron was detected at a concentration of 743 µg/L in upgradient well 44-GW06DW, which exceeded the North Carolina screening standard of 300 µg/L. None of the other TAL total metals that were detected in the two samples obtained from the deep aquifer exceeded MCL or NCWQS levels.

4.3.2.3 Summary

Inorganics were the most prevalent and widely distributed constituents in groundwater at Site 44. Concentrations of TAL total metals were generally higher in shallow groundwater samples than in samples collected from the deeper aquifer. Iron and manganese were the most prevalent inorganic analytes, detected at concentrations that exceeded standards in each of the groundwater samples. Table 4-2 presents a summary of inorganic analytes in excess of applicable state standards.

Positive detections of organic compounds were limited to the temporary monitoring well (44-TW01) and an existing shallow monitoring well (44-GW03). Of the eight organic compounds detected in

44-GW03, only tetrachloroethene and naphthalene concentrations exceeded state or federal screening standards. Only one of the three volatile compounds detected in sample 44-TW01, vinyl chloride, exceeded screening criteria.

4.3.3 Surface Water Investigation

Environmental samples were collected from Edwards Creek and an unnamed tributary to Edwards Creek as part of the surface water investigation at Site 44. A total of eight surface water samples were collected at Site 44 during the initial sampling event in May of 1995. Five of the sampling stations were located in Edwards Creek and three were located in an unnamed tributary to Edwards Creek. Each of the eight surface water samples were analyzed for full TCL organics and TAL inorganics (both total and dissolved fractions), using CLP protocols and Level IV data quality.

An additional eight samples were later collected to more adequately assess the extent of surface water contamination in Edwards Creek. The eight samples from Edwards Creek were submitted in September of 1995 for laboratory analysis of volatile organic compounds only. Based upon the results of the initial surface water sampling event, four of the eight additional samples were collected from previously sampled locations (44-EC-SW01 through 44-EC-SW04). The remaining four additional samples were obtained locations upgradient of the initial sampling stations, toward the southeastern portion of Camp Geiger.

Analytical results from the surface water investigation at Site 44 are provided in the subsections which follow. Table 4-2 provides a summary of surface water contamination. A positive detection summary of organic compounds found in surface water samples is provided in Table 4-10. Analytical results from supplemental samples obtained from Edwards Creek are presented in Table 4-11. Total and dissolved metal results from both surface water bodies at Site 44 are presented in Tables 4-12 and 4-13. Pesticide and PCB organic compounds were not detected in any of the eight surface water samples submitted for those analyses and, therefore, will not be considered further. Semivolatile organic compounds were not detected in any of the surface water samples obtained from Edwards Creek and, correspondingly, will not be addressed.

4.3.3.1 Edwards Creek

A total of 6 VOCs were detected among the 13 surface water samples obtained from Edwards Creek. As provided in Tables 4-10 and 4-11, both 1,2-dichloroethene (total) and trichloroethene were detected in each of the 13 samples obtained from Edwards Creek. The maximum concentrations of 1,2-dichloroethene (total) and trichloroethene were 150 and 66 µg/L. Vinyl chloride and 1,1,2,2-tetrachloroethane were next most prevalent VOCs detected among Edwards Creek surface water samples. Vinyl chloride was detected in eight surface water samples with a maximum concentration of 38 µg/L. As provided in Table 4-2, 1,1,2,2-tetrachloroethane was detected in 12 of the samples obtained from Edwards Creek with a maximum concentration of 42 µg/L. Nine of the 1,1,2,2-tetrachloroethane detections exceeded the NCWQS screening value of 10.8 µg/L. Twelve of the 1,2-dichloroethene (total) detections exceeded the NCWQS (15A NCAC 2B) screening value of 7.0 µg/L. None of the other positive VOC detections exceeded applicable screening values. Lastly, the VOCs 1,1-dichloroethene and 1,1,2-trichloroethane were also detected among the surface water samples at maximum concentrations of 2 and 1 µg/L, respectively.

As presented in Table 4-12, thirteen of 23 TAL total metals were positively identified among the five surface water samples obtained from Edwards Creek (antimony, arsenic, beryllium, cadmium,

chromium, cobalt, mercury, selenium, silver, and thallium were not detected). Positive detections of metals were compared to screening standards for surface water bodies classified as fresh water (i.e., containing less than five percent saltwater). Lead was detected in only one of the five surface water samples obtained from Edwards Creek in excess of the 10.4 µg/L maximum base background value. None of the total metal concentrations among the surface water samples exceeded state or federal screening values.

4.3.3.2 Unnamed Tributary

Positive detections of two volatile organic compounds were observed among the three surface water samples obtained from the unnamed tributary to Edwards Creek. The VOCs 1,2-dichloroethene and trichloroethene were detected at concentrations of 5 and 2 µg/L in sample UT-SW03, located approximately 150 feet upstream of the Edwards Creek confluence. Phenol was the only SVOC detected among surface water samples submitted for laboratory analysis from Site 44. At sampling location UT-SW01 phenol was detected at a concentration of 1 µg/L. None of the volatile or semivolatile detections exceeded applicable state or federal screening values.

Laboratory analyses of four surface water samples retained from the unnamed tributary indicate that 12 of 23 possible total metals were positively detected. As indicated in Table 4-2, none of the total metal concentrations in the three surface water samples obtained from the unnamed tributary to Edwards Creek exceeded state or federal screening values.

4.3.4 **Sediment Investigation**

Environmental samples were collected from Edwards Creek and an unnamed tributary to Edwards Creek as part of the sediment investigation at Site 44. A total of 16 sediment samples were collected at Site 44; 2 samples were collected from each of the 8 sampling stations. Samples were collected from zero to six inches and also from six to twelve inches into the sediment. Ten of the 16 samples were retained from Edwards Creek and the remaining 6 samples were obtained from the unnamed tributary to Edwards Creek that lies beyond the southeast portion of the site. Each of the 16 sediment samples was analyzed for full TCL organics and TAL inorganics, using CLP protocols and Level IV data quality.

Analytical results from the sediment investigation at Site 44 are provided in the subsections which follow. Table 4-2 provides a summary of sediment contamination. A positive detection summary of organic compounds found in Edwards Creek and the unnamed tributary to Edwards Creek are provided in Table 4-14. Total metal results from sediment samples obtained as part of the Site 44 investigation are presented in Table 4-15. PCB compounds were not detected in any of 16 sediment samples and therefore will not be addressed.

4.3.4.1 Edwards Creek

Unlike surface water, volatile organic compounds were not detected in any of the ten sediment samples obtained from Edwards Creek. A total of seven SVOCs were detected, however, among seven of the ten sediment samples; six of the seven SVOCs detected were PAHs. A majority of the SVOC detections in Edwards Creek sediment samples were from station EC-SD05, located downstream of the unnamed tributary confluence. Pentachlorophenol was positively detected in two of the sediment samples at a maximum concentration of 740 µg/kg in upstream location EC-SD01. As indicated in Table 4-14, the maximum PAH concentration was that of fluoranthene at 120 µg/kg.

Phenanthrene, pyrene, chrysene, benzo(b)fluoranthene, and benzo(g,h,i)perylene were also detected in at least one of the ten Edwards Creek samples. None of the positive SVOC detections in samples obtained from Edwards Creek exceeded applicable NOAA screening values.

The pesticides 4,4'-DDE and 4,4'-DDD were detected in each of the ten sediment samples obtained from Edwards Creek. Both of these pesticides were detected at their respective maximum concentrations within a sample obtained from station EC-SD05, located downstream of the unnamed tributary confluence. As indicated in Table 4-2, each of the 4,4'-DDE and 4,4'-DDD detections were in excess of NOAA Effects Range-Low (ER-L) screening values. Alpha-chlordane and gamma-chlordane were detected in nine of the ten sediment samples at concentrations in excess of screening values. Both alpha-chlordane and gamma-chlordane were detected at maximum concentrations of 14 and 16 µg/kg in sample EC-SD05. The pesticide 4,4'-DDT was detected in eight of the ten Edwards Creek sediment samples, at concentrations exceeding screening values. The maximum 4,4'-DDT detection, 130 µg/kg, was also observed in one of the samples obtained from station EC-SD05. Each of the pesticide detections in sediment samples represented an exceedance of appropriate NOAA screening criteria.

Twenty of 23 TAL total metals were positively identified among the ten Edwards Creek sediment samples (antimony, mercury, and thallium were not detected). Lead and zinc were detected at concentrations in excess of their respective NOAA screening values of 35 and 120 mg/kg. As provided in Table 4-15, one detection of lead at 43.5 mg/kg and one detection of zinc at 144 mg/kg exceeded applicable sediment screening values in a sample obtained from station EC-SD05. Neither the lead nor the zinc detection in EC-SD05 exceeded base-specific background concentrations (refer to Appendix P).

4.3.4.2 Unnamed Tributary

Acetone was the only volatile organic compound detected among the six unnamed tributary sediment samples. No other VOC was detected among sediment samples from both Edwards Creek and the unnamed tributary to Edwards Creek. Acetone was identified at a concentration of 610 µg/kg in a sample obtained from station UT-SD01, which exceeded ten times the maximum QA/QC blank concentration.

A total of 11 semivolatile compounds were identified in sediment samples obtained from the unnamed tributary to Edwards Creek. As provided in Table 4-14, 9 of the 11 SVOCs detected were PAH compounds. No semivolatile compounds were detected at location UT-SD01, located upstream of two 36-inch drainage culverts which discharge to the unnamed tributary. The majority of maximum SVOC detections were observed in samples obtained from location UT-SD03. The maximum semivolatile concentration among sediment samples obtained from the unnamed tributary was that of fluoranthene. As presented in Table 4-2, four semivolatiles were each detected once among unnamed tributary samples at concentrations exceeding applicable NOAA screening values. Fluoranthene, pyrene, and chrysene were detected at their maximum concentrations of 740, 490, and 460 µg/kg in a sample obtained from UT-SD03, approximately 150 feet from the confluence with Edwards Creek. Benzo(g,h,i)perylene was detected at a maximum concentration of 71 µg/kg in sample UT-SD02, adjacent to the culvert outfall.

The pesticides 4,4'-DDD, and 4,4'-DDE were detected in each of the six unnamed tributary sediment samples. As indicated in Table 4-2, 4,4'-DDD and 4,4'-DDE were detected at maximum concentrations of 310 and 770 µg/kg in a sample obtained from station UT-SD02. The pesticide

4,4'-DDT was detected in three of the six samples at a maximum concentration of 3.7 µg/kg. Alpha-chlordane and gamma-chlordane were detected in four of the six samples at maximum concentrations of 7.8 and 9.5 µg/kg. Each of the pesticide detections in sediment samples represented an exceedance of appropriate NOAA screening criteria. The upstream sampling station, UT-SD01, had the fewest detections of pesticide compounds.

Sixteen of 23 TAL total metals were positively identified in the seven sediment samples from the unnamed tributary (antimony, beryllium, cadmium, cobalt, mercury, silver, and thallium were not detected). Of the 16 metals detected, only lead was identified at concentrations in excess of NOAA ER-L screening value of 35 mg/kg. As provided in Table 4-15, lead was detected twice among the six sediment samples obtained from the unnamed tributary at concentrations in excess of the screening value. Lead was detected at 53 and 56 mg/kg in the two samples obtained from station UT-SD03. All other TAL metals detected in sediment samples from the unnamed tributary were within base-specific background concentrations.

4.4 Extent of Contamination

This section addresses the extent of contamination within soil, groundwater, surface water, and sediment at Site 44.

4.4.1 Extent of Soil Contamination

Positive detections of organic compounds in both surface and subsurface soil samples at Site 44 are depicted on Figures 4-1 and 4-2. Selected TAL metal detections among soil samples are depicted on Figures 4-3 and 4-4. The following subsections detail the presence of both organic compounds and inorganic analytes in soil samples at Site 44. As addressed in Section 4.3.1, volatile and PCB organic contaminants were not detected in any of the soil samples submitted for laboratory analyses. As a result of those analyses, the extent of volatile and PCB contamination in soil will not be addressed.

4.4.1.1 Semivolatiles

The presence and dispersion of SVOCs in soil, particularly the two PAH compounds, are most likely the result of former operations at Site 44. Concentrations of PAH compounds in soil samples are consistent with the historical use of the site as a dump and indicative of waste or refuse disposal. Semivolatile compounds were identified in both surface and subsurface soil samples obtained from the eastern portion of the site. As depicted on Figures 4-1 and 4-2, concentrations of SVOCs were typically higher in surface samples obtained at Site 44. In general, soil analytical results correspond directly to the visual identification of fill or graded soil material observed during the field investigation (see Appendices A, B, and C for soil descriptions).

4.4.1.3 Pesticides

Positive detections of pesticides were observed in both surface and subsurface soil samples throughout Site 44. As Figures 4-1 and 4-2 depict, the detected pesticide levels were generally low and most likely the result of former base-wide application and use of pesticides. However, soils samples obtained from the eastern portion of the study area had a majority of the pesticide concentrations. As described in Section 2.0, the eastern and central portions of the study may have been graded during site operations; the reworked soil may have also included residual concentrations

of pesticides. However, the frequency and overall concentration of pesticides in soil does not suggest pesticide disposal activities.

4.4.1.4 Metals

As addressed in Section 4.3.1 and depicted in Tables 4-4 and 4-6, only two of the 26 samples submitted for analyses had TAL metal concentrations greater than one order of magnitude above twice the average base-specific background levels. The metals copper and zinc were detected at concentrations greater than one order of magnitude above base-specific background levels in a monitoring well test boring located within the central portion of the study area. Inorganic analytes were detected in both surface and subsurface soil samples from the study area, as depicted on Figures 4-3 and 4-4. Findings from the analytical program are consistent with visual observations of buried metallic objects and graded surface material recorded during the field investigation (see Appendices A, B, and C). The concentrations of metals which exceeded base-specific background levels were in samples obtained from portions of the study area that coincide directly with graded areas and buried material. Elevated concentrations of metal analytes are most probably the result of buried material, in the presence of naturally-occurring acidic soils.

4.4.2 **Extent of Groundwater Contamination**

Positive detections of organic compounds in groundwater samples collected at Site 44 are depicted on Figure 4-5. Figure 4-6 presents TAL metal groundwater sampling results in excess of either Federal MCL or North Carolina WQS levels. As addressed in Section 4.3.2, organic pesticide and PCB compounds were not detected in any of the shallow or deep aquifer samples submitted for analysis from Site 44. As a result of those analyses, the extent of pesticides and PCBs in groundwater will not be addressed.

4.4.2.1 Volatiles

Positive detections of volatile compounds were limited to samples obtained from the shallow aquifer. The lack of positive VOC detections in samples obtained from the deep aquifer suggests that these contaminants have not migrated from the surficial aquifer.

Tetrachloroethene was detected at an estimated concentration of 1 µg/L in the groundwater sample obtained from existing well 44-GW03. No other volatile contaminants were detected at this location; however, six semivolatile compounds were detected. The concentration of tetrachloroethene in well 44-GW03 represents an exceedance of the NCWQS of 0.7 µg/L. The lack of positive detections in other permanent wells which are hydraulically downgradient to well 44-GW03, indicates that the extent of volatile contamination in groundwater is limited to that location. Moreover, the relatively low VOC concentration suggest that its presence may be the result of unintentional spillage or limited disposal rather than from long-term disposal or buried containers.

Vinyl chloride, 1,2-dichloroethene (total), and trichloroethene were detected at concentrations of 10, 15, and 1 µg/L in the sample obtained from temporary well 44-TW01. None of these volatile compounds were detected in any of the other Site 44 monitoring wells; however, the same compounds were detected in a majority of surface water samples from nearby Edwards Creek. Temporary well 44-TW01 was installed in a low lying area, within 50 feet of Edwards Creek. During periods of seasonal flooding the same volatile compounds detected in surface water samples

most probably migrated from surface water to groundwater in areas immediately adjacent to Edwards Creek. The ground surface elevation at temporary well location 44-TW01 is approximately 2 feet above the Edwards Creek stream channel.

4.4.2.2 Semivolatiles

Semivolatile organic compounds were detected in only one of the nine groundwater samples from Site 44. No SVOCs were detected in the two samples obtained from the deep aquifer (i.e., the Castle Hayne aquifer), which suggests that contamination has not migrated to depths greater than 70 feet below ground surface.

A total of seven semivolatile compounds were detected in the sample obtained from shallow monitoring well 44-GW03, located near the main site access route (see Figure 4-5). Five of the six SVOCs were detected at concentrations of less than 15 µg/L, naphthalene was detected at a concentration of 71 µg/L. Previous soil and groundwater analytical results from the same location, collected during the 1991 Site Inspection (refer to Section 1.4), also exhibited similar concentrations of semivolatile compounds. No semivolatile compounds were detected in the four soil samples (WA-SB01 through WA-SB04) collected within 15 feet of monitoring well 44-GW03 during the RI. As in the case of volatile organics, the limited occurrence of semivolatile compounds in groundwater at this location suggests that they may be the result of spillage or limited disposal rather than from long-term disposal or buried containers.

4.4.2.3 Metals

Inorganic analytes were detected in each of the nine groundwater samples submitted for analyses from Site 44. Iron and manganese were the only TAL total metals detected at levels in excess of either Federal MCL or North Carolina WQS (refer to Figure 4-6). Positive detections of both iron and manganese were distributed throughout the site, indicative of natural site conditions rather than disposal activities. Generally, concentrations of TAL metals in groundwater at Site 44 were higher in samples obtained from the shallow aquifer.

Elevated total metal observations have been recorded at other MCB, Camp Lejeune sites and have been attributed as the likely consequence of loose surficial soils. During sampling, a low flow purge method was utilized to minimize the presence suspended solids or colloids in samples that are associated with the surficial soils. The DON is currently evaluating the presence and distribution of total and dissolved metals in groundwater throughout the facility. The draft report entitled "Evaluation of Metals in Groundwater at MCB, Camp Lejeune, North Carolina," (provided as Appendix P) addresses the pervasiveness of total metals in groundwater and identifies a number of potential causes. Preliminary conclusions of the study support the opinion that total metal concentrations in groundwater are due more to geologic conditions (i.e., naturally occurring concentrations and unconsolidated soils) and sample acquisition methods than to mobile metal concentrations in the surficial aquifer.

4.4.3 **Extent of Surface Water Contamination**

Figure 4-7 depicts the study area relative to IR Sites 93 and 89, which are situated upgradient of Site 44. Positive detections of organic compounds in surface water samples collected at Site 44 are depicted on Figure 4-8. A summary of site contamination is presented in Table 4-2. As addressed in Section 4.3.3, pesticide and PCB contaminants were not detected in any of the surface water

samples submitted for analysis from Site 44. As a result of those analyses, the extent of pesticides and PCBs in surface water will not be addressed. Semivolatile organic compounds were not detected among surface water samples obtained from Edwards Creek, correspondingly, the extent of semivolatile contamination in Edwards Creek will not be addressed.

4.4.3.1 Volatiles

Edwards Creek

As depicted on Figure 4-8, the following VOCs were detected at least once among the 13 surface water samples obtained from Edwards Creek (the maximum concentration of each VOC is provided):

● Vinyl chloride	38 µg/L
● 1,1-Dichloroethene	2 µg/L
● 1,2-Dichloroethene (total)	150 µg/L
● Trichloroethene	66 µg/L
● 1,1,2-Trichloroethane	1 µg/L
● 1,1,2,2-Tetrachloroethane	42 µg/L

Trichloroethene, 1,2-dichloroethene (total), and 1,1,2,2-tetrachloroethane were detected in at least 12 of the 13 surface water samples obtained from Edwards Creek. Vinyl chloride and 1,1-Dichloroethene were detected eight and three times, respectively, among the surface water samples. Lastly, 1,1,2-trichloroethane was detected in only one Edwards Creek surface water sample.

Several VOC concentrations were detected in samples obtained from portions of Edwards Creek that are upgradient of Site 44. As depicted on Figure 4-8, results from both the initial and supplemental sampling events illustrate a reduction in total VOC concentrations from upgradient to downgradient sampling stations. Volatile analytical results from the September of 1995 sampling event were generally lower than results from the initial sampling event, conducted in May of 1995; however, the same trend of relatively higher upgradient and lower downgradient VOC concentrations is evident on Figure 4-8.

During the September 1995 sampling event an additional four sampling stations were added to the Edwards Creek surface water investigation. As shown on Figure 4-7, the additional sampling stations were placed several hundred feet upstream of Site 44, beyond the initial sampling stations. The analytical data from Edwards Creek suggests that a possible VOC source lies somewhere in the southeastern portion of Camp Geiger. Several storage and maintenance facilities are located in this general area of Camp Geiger. Two former waste oil underground storage tanks, Sites 89 and 93, are also situated in this general vicinity.

Unnamed Tributary

Two volatile contaminants, 1,2-dichloroethene and trichloroethene, were detected at concentrations of 5 and 2 µg/L in a sample obtained from the unnamed tributary to Edwards Creek. The same two contaminants were identified among each of the Edwards Creek surface water samples. As depicted on Figure 4-7, sampling station UT-SW03 is located approximately 150 feet upstream of the Edwards Creek confluence. The downstream portions of both Edwards Creek and its tributary are

of lesser hydraulic gradient in this area. It is possible that VOCs at this location migrated from Edwards Creek, given that the same contaminants were not detected in samples obtained from upstream sampling stations.

4.4.3.3 Semivolatiles

Unnamed Tributary

One semivolatile compound was detected among the three samples submitted for analysis from the unnamed tributary to Edwards Creek. Phenol was detected at a concentration of 1 µg/L in sample UT-SW01, located near the headwaters of the tributary. The trace concentration and lack of other corroborating semivolatile detections make it difficult to suggest a possible source of phenol at this location.

4.4.3.3 Metals

Edwards Creek

Lead was the only TAL metals identified among five samples obtained from the Edwards Creek that exceeded base background levels. None of the metal detections exceeded state screening values. At location EC-SW03 lead was detected at a concentration of 11.2 µg/L, which slightly exceeded the 10.4 µg/L background concentration.

Unnamed Tributary

None of the TAL metals identified in the three surface water samples obtained from the unnamed tributary to Edwards Creek were detected at concentrations in excess of chronic screening values. Positive detections of metals were compared to standards for surface water bodies classified as fresh (i.e., containing less than five percent saltwater).

4.4.4 **Extent of Sediment Contamination**

Positive detections of organic compounds in sediment samples collected at Site 44 are depicted on Figure 4-9. Figure 4-10 presents TAL metal sampling results in excess of federal sediment screening values. A summary of site contamination is presented in Table 4-2. As addressed in Section 4.3.4, PCB contaminants were not detected in any of the 16 sediment samples submitted for analyses from Site 44. As a result of those analyses, the extent of PCBs in sediment will not be addressed.

4.4.4.1 Volatiles

Unnamed Tributary

Only one VOC was detected among the 16 sediment samples obtained from Edwards Creek and the unnamed tributary to Edwards Creek. Acetone was identified at a concentration of 610 µg/kg in a sample collected from a slightly upstream location to the southeast of the study area. Sampling station UT-SD01 was positioned in a separate drainage basin from the two other unnamed tributary sampling stations. The limited occurrence of acetone suggests that its presence may be the result of laboratory contamination since there is no history of usage at this site.

4.4.4.2 Semivolatiles

Edwards Creek and the Unnamed Tributary

A total of 12 semivolatile compounds were detected within the 16 sediment samples obtained from Edwards Creek and an unnamed tributary which lies to the southeast of Site 44. As Figure 4-9 suggests, the highest concentrations of SVOCs were detected at two sampling stations from the unnamed tributary. The maximum PAH concentration was that of fluoranthene, 740 µg/kg, in a sample obtained from the unnamed tributary. Concentrations of SVOCs in the two samples located immediately downstream of a drainage culvert in the unnamed tributary were higher than those detections observed upstream and adjacent to the study area. Excess liquid discharge from a lift station flows through the drainage culvert and into Edwards Creek via the unnamed tributary.

Edwards Creek serves as a main drainage basin for the northern portion of MCAS New River and the southeastern portion of Camp Geiger. Surface water runoff from residential, light industrial, and maintenance areas flows to the New River via the Edwards Creek and its tributaries. Given the low concentration of semivolatile compounds among sediment samples and the lack of similar soil analytical data at Site 44, suggests that contaminants may have migrated to nearby surface water bodies from various off-site sources such as roadways, maintenance facilities, and residential areas.

4.4.4.3 Pesticides

Edwards Creek and the Unnamed Tributary

The pesticides aldrin, heptachlor epoxide, 4,4'-DDE, 4,4'-DDD, 4,4'-DDT, alpha-chlordane, and gamma-chlordane were detected in sediment samples retained for analysis from Edwards Creek and an unnamed tributary to the southeast of Site 44. As depicted on Figure 4-9, the maximum concentrations of pesticides were obtained from samples located downstream of the study area. Higher detections of pesticides at this downstream location may be the result of particles settling out of suspension as they reach this area of lesser hydraulic gradient. In general, pesticides were observed throughout Edwards Creek at low and varying concentrations. These positive detections in Edwards Creek are typical of concentrations observed in sediments throughout MCB, Camp Lejeune and are most likely the result of former base-wide pesticide application.

4.4.4.4 Metals

Edwards Creek and the Unnamed Tributary

Lead and zinc were each identified at concentrations in excess of NOAA ER-L screening values. As depicted on Figure 4-10, lead was detected in excess of the 35 mg/kg screening value in three samples obtained from Edwards Creek and the unnamed tributary to Edwards Creek. Lead was detected at 53 and 56 mg/kg in the two samples obtained from a single station, UT-SD03, located on the unnamed tributary. One detection of lead at 43.5 mg/kg also exceeded the sediment screening value in a sample obtained from Edwards Creek, downstream of the unnamed tributary confluence. Zinc was detected at 144 mg/kg in the same sample obtained from Edwards Creek in excess of the 120 mg/kg screening value. Neither the lead nor the zinc detections in samples obtained from Site 44 exceeded maximum base-specific background concentrations (refer to Appendix P). The observed concentrations of metals among sediment samples obtained from Site 44 are not indicative of disposal activities.

4.5 References

Baker Environmental, Inc. December 1994. Remedial Investigation/Feasibility Study Work Plan for Operable Unit No. 6 (Sites 36, 43, 44, 54, and 86), Marine Corps Base Camp Lejeune, North Carolina. Final. Prepared for the Department of the Navy, Naval Facilities Engineering Command, Atlantic Division, Norfolk, Virginia.

Greenhorne & O'Mara, Inc. 1992. Wellhead Monitoring Study Marine Corps Base, Camp Lejeune, North Carolina. Preliminary Draft. Prepared for Department of the Navy, Naval Facilities Engineering Command, Atlantic Division, Norfolk, Virginia.

United States Environmental Protection Agency (USEPA). 1988. Laboratory Guidelines for Evaluating Inorganics Analysis. Prepared for: Hazardous Site Evaluation Division, U.S. Environmental Protection Agency. Compiled by: Ruth Bleyler. Prepared by: The USEPA Data Review Work Group.

USEPA. 1989. United States Environmental Protection Agency. Risk Assessment Guidance for Superfund Volume II. Environmental Evaluation Manual Interim Final. Office of Solid Waste and Emergency Response. Washington, D.C. EPA/540/1-89-001. May 1989.

USEPA. 1991. National Functional Guidelines for Organic Data Review. Draft. USEPA Contract Laboratory Program.

SECTION 4.0 TABLES

TABLE 4-1

SUMMARY OF REJECTED DATA
 SITE 44, JONES STREET DUMP
 REMEDIAL INVESTIGATION, CTO-0303
 MCAS, NEW RIVER, NORTH CAROLINA

Media	Sample Number	Chemical/Category	Comment	
Soils	44-OA-SB06-00RE 44-OA-SB04-00	VOCs	1	
	44-WA-SB02-00 44-WA-SB02-03 44-WA-SB03-00 44-WA-SB03-03 44-OA-SB03-00 44-OA-SB03-01 44-OA-SB06-00 44-OA-SB06-02	SVOCs	2	
	44-OA-SB03-00 44-OA-SB05-00	4,4'-DDE	3	
	44-WA-SB02-00 44-WA-SB02-03 44-WA-SB03-00 44-WA-SB03-03 44-OA-SB03-00 44-OA-SB03-01 44-OA-SB06-00 44-OA-SB06-02	Lead	4	
	Groundwater	86-GW19DW-00	VOCs	1
		44-GW01DW-03	4,4'-DDE 4,4'-DDD	3

Comments:

1. Reject all results for the re-analyzed sample(s) in favor of the original sample(s) due to noncompliant internal standard areas.
2. Reject results in favor of the re-extracted sample results due to non compliant surrogate recoveries.
3. For the specified compounds, reject results in favor of the diluted analysis for the sample. Results for all other compounds are from the undiluted analysis.
4. Reject all nondetect results because the matrix spike recovery was below 30%.

TABLE 4-2

**SUMMARY OF SITE CONTAMINATION
SITE 44, JONES STREET DUMP
REMEDIAL INVESTIGATION, CTO-0303
MCB, CAMP LEJEUNE, NORTH CAROLINA**

Media	Fraction	Detected Contaminants	Comparison Criteria		Site Contamination				
			Standard	Base Background	Min.	Max.	Max. Location	Detection Frequency	Distribution
Surface Soil	Volatiles	ND	NA	NA				0/13	
	Semivolatiles	bis(2-Chloroethyl)ether	NA	NA	550	550	OA-SB06	1/13	eastern
		2,6-Dinitrotoluene	NA	NA	380	380	OA-SB02	1/13	open area
		I(1,2,3-cd)pyrene (PAH)	NA	NA	220	220	OA-SB05	1/13	east central
		B(g,h,i)perylene (PAH)	NA	NA	57	200	OA-SB05	2/13	east central
	Pesticides	4-4'-DDE	NA	NA	10	140	OA-SB05	4/13	scattered
		4-4'-DDD	NA	NA	7.4	7.4	OA-SB03	1/13	near marsh area
		4-4'-DDT	NA	NA	4.6	45	OA-SB03	4/13	scattered
	PCBs	ND	NA	NA				0/7	
	Metals (1)	Arsenic	NA	1.3	0.8	4.9	WA-SB02	13/13	11 exceed BB, evenly dispersed
		Chromium	NA	6.7	4.2	16.4	OA-SB01	12/13	11 exceed BB, evenly dispersed
		Copper	NA	7.2	0.9	910	OA-SB03	12/13	1 exceeds BB, near marsh area
		Lead	NA	23.7	5.9	31.7	OA-SB03	11/13	1 exceeds BB, near marsh area
		Manganese	NA	18.5	4.9	44.2	OA-SB03	13/13	11 exceed BB, evenly dispersed
		Zinc	NA	13.9	2.7	156	OA-SB03	13/13	2 exceed BB, max. near marsh
Subsurface Soil	Volatiles	ND	NA	NA				0/13	
	Semivolatiles	I(1,2,3-cd)pyrene (PAH)	NA	NA	55	130	OA-SB05	2/13	east central
		B(g,h,i)perylene (PAH)	NA	NA	40	120	OA-SB05	3/13	east central
	Pesticides	4,4'-DDE	NA	NA	3.2	370	44-GW01DW	4/13	scattered
		4,4'-DDD	NA	NA	5.6	2,500	44-GW01DW	4/13	scattered
		4,4'-DDT	NA	NA	150	150	44-GW01DW	1/13	central
	PCBs	ND	NA	NA				0/7	

TABLE 4-2 (Continued)

SUMMARY OF SITE CONTAMINATION
 SITE 44, JONES STREET DUMP
 REMEDIAL INVESTIGATION, CTO-0303
 MCB, CAMP LEJEUNE, NORTH CAROLINA

Media	Fraction	Detected Contaminants	Comparison Criteria		Site Contamination				
			Standard	Base Background	Min.	Max.	Max. Location	Detection Frequency	Distribution
Subsurface Soil (Continued)	Metals (1)	Arsenic	NA	1.9	0.3	2.5	WA-SB04	10/13	1 exceeds BB, west central
		Copper	NA	2.4	0.4	3	44-GW01DW	9/13	1 exceeds BB, central
		Lead	NA	8.3	1.4	9	44-GW01DW	11/13	2 exceed BB, central
		Manganese	NA	7.9	1.3	9.3	WA-SB02	13/13	2 exceed BB
		Nickel	NA	3.7	1.3	15.8	44-GW01DW	6/13	2 exceed BB
		Zinc	NA	6.7	0.8	10.8	WA-SB04	12/13	1 exceeds BB, west central
Groundwater	Volatiles	Vinyl Chloride	NCWQS - 0.015	NA	10	10	44-TW01	1/9	1 exceeds standard, marsh area
		1,2-Dichloroethene (total)	MCL - 70	NA	15	15	44-TW01	1/9	does not exceed standard, marsh
		Trichloroethene	MCL - 5	NA	1	1	44-TW01	1/9	does not exceed standard, marsh
		Tetrachloroethene	NCWQS - 0.7	NA	1	1	44-GW03	1/9	1 exceeds standard, southwestern
	Semivolatiles	Naphthalene (PAH)	NCWQS - 21	NA	71	71	44-GW03	1/9	1 exceeds standard, southwestern
		2-Methylnaphthalene	NA	NA	4	4	44-GW03	1/9	southwestern, near access road
		Acenaphthene (PAH)	NCWQS - 800	NA	13	13	44-GW03	1/9	does not exceed standard
		Dibenzofuran	NA	NA	6	6	44-GW03	1/9	southwestern, near access road
		Fluorene (PAH)	NCWQS - 280	NA	7	7	44-GW03	1/9	does not exceed standard
		Phenanthrene (PAH)	NCWQS - 210	NA	7	7	44-GW03	1/9	does not exceed standard
		Carbazole	NA	NA	4	4	44-GW03	1/9	southwestern, near access road
	Pesticides	ND	NCWQS/MCL	NA				0/9	
	PCBs	ND	NCWQS/MCL	NA				0/9	
	Total Metals	Iron	NCWQS - 300	NA	285	72,900	44-GW04	9/9	8 exceed standard, scattered
Manganese		NCWQS - 50	NA	21.6	241	44-GW04	8/9	5 exceed standard, scattered	

TABLE 4-2 (Continued)

**SUMMARY OF SITE CONTAMINATION
SITE 44, JONES STREET DUMP
REMEDIAL INVESTIGATION, CTO-0303
MCB, CAMP LEJEUNE, NORTH CAROLINA**

Media	Fraction	Detected Contaminants	Comparison Criteria		Site Contamination				
			Standard	Base Background	Min.	Max.	Max. Location	Detection Frequency	Distribution
Surface Water (2)	Volatiles	Vinyl Chloride	NCWQS - 525	NA	7	38	EC-SW08	8/16	max. upgradient, decreases by site
		1,1-Dichloroethene	NCWQS - 3.2	NA	1	2	EC-SW06	3/16	each detection upgradient
		1,2-Dichloroethene (total)	NCWQS - 7.0	NA	2	150	EC-SW01	14/16	12 exceed standard, max. upgradient
		Trichloroethene	NCWQS - 92.4	NA	2	66	EC-SW01	14/16	max. upgradient, decreases by site
		1,1,2-Trichloroethane	NCWQS - 42	NA	1	1	EC-SW08	1/16	upgradient
		1,1,2,2-Tetrachloroethane	NCWQS - 10.8	NA	5	42	EC-SW08	12/16	9 exceed standard, max. upgradient
	Semivolatiles	Phenol	NCWQS - 300	NA	1	1	UT-SW01	1/8	low detection, UT
	Pesticides	ND	NCWQS/NOAA	NA				0/8	
	PCBs	ND	NCWQS/NOAA	NA				0/8	
Metals (3)	Lead	NCWQS - 25	10.4	0.8	11.2	EC-SW02	2/8	1 exceeds BB not standard	
Sediment	Volatiles	Acetone	NA	NA	15	610	UT-SD01	11/16	1 exceeds blank cont. level (240)
	Semivolatiles	Pentachlorophenol	NA	NA	340	740	EC-SD01	2/16	up and downgradient, EC
		Phenanthrene (PAH)	NOAA - 225	NA	49	250	UT-SD03	5/16	primarily UT
		Carbazole	NA	NA	79	79	UT-SD03	1/16	near confluence with EC, UT
		Fluoranthene (PAH)	NOAA - 600	NA	95	740	UT-SD03	6/16	1 exceeds standard, UT
		Pyrene (PAH)	NOAA - 350	NA	42	490	UT-SD03	7/16	1 exceeds standard, UT
		Butylbenzylphthalate	NA	NA	48	48	UT-SD02	1/16	by concrete outflow/culvert, UT
		B(a)anthracene (PAH)	NOAA - 230	NA	50	170	UT-SD03	3/16	do not exceed standard, UT
		Chrysene (PAH)	NOAA - 400	NA	44	460	UT-SD03	7/16	1 exceeds standard, UT
		B(b)fluoranthene (PAH)	NA	NA	52	600	UT-SD03	6/16	UT and downgradient of UT
		B(k)fluoranthene (PAH)	NA	NA	49	200	UT-SD03	3/16	all detections from UT
Benzo(a)pyrene (PAH)	NOAA - 400	NA	56	300	UT-SD03	3/16	do not exceed standard, UT		
B(g,h,i)perylene (PAH)	NA	NA	49	71	UT-SD02	2/16	1 detection EC and 1 UT		

TABLE 4-2 (Continued)

SUMMARY OF SITE CONTAMINATION
 SITE 44, JONES STREET DUMP
 REMEDIAL INVESTIGATION, CTO-0303
 MCB, CAMP LEJEUNE, NORTH CAROLINA

Media	Fraction	Detected Contaminants	Comparison Criteria		Site Contamination				
			Standard	Base Background	Min.	Max.	Max. Location	Detection Frequency	Distribution
Sediment (Continued)	Pesticides	Aldrin	NA	NA	2.6	2.6	UT-SD03	1/14	UT
		Heptachlor Epoxide	NA	NA	5.2	5.2	UT-SD03	1/14	UT
		4,4'-DDE	NOAA - 2	NA	9.3	310	UT-SD02	16/16	16 exceed standard
		4,4'-DDD	NOAA - 2	NA	5.5	770	UT-SD02	16/16	16 exceed standard
		4,4'-DDT	NOAA - 1	NA	2.5	130	EC-SD05	10/14	10 exceed standard, prevalent
		alpha-Chlordane	NOAA - 0.5	NA	2	14	EC-SD05	13/16	13 exceed standard, prevalent
		gamma-Chlordane	NOAA - 0.5	NA	2.7	16	EC-SD05	13/16	13 exceed standard, prevalent
	PCBs	ND	NOAA	NA				0/13	
	Metals (3)	Lead	NOAA - 35	314	8.4	56.3	UT-SD03	16/16	3 exceed standard, not BB
		Zinc	NOAA - 120	926	6.3	144	EC-SD05	16/16	1 exceeds standard, not BB

Notes:

- Concentrations are presented in µg/L for liquid and µg/Kg for solids (ppb), metal concentrations for soils and sediments are presented in mg/Kg (ppm).
 - (1) Metals in both surface and subsurface soils were compared to twice the average base background positive concentrations for priority pollutant metals only (i.e., antimony, arsenic, beryllium, cadmium, chromium, copper, lead, mercury, nickel, selenium, silver, thallium, zinc).
 - (2) Surface water detections were compared to appropriate NCWQS and NOAA screening values, based upon the observed percentage of saltwater at each sampling location.
 - (3) Total metals in surface water and sediment were compared to the maximum positive detections in upgradient samples at MCB, Camp Lejeune.
- BB - Base background, value equals two times average value for soil and the maximum value for surface water and sediment (refer to Appendix P)
- BEHP - bis(2-ethylhexyl)phthalate
- EC - Edwards Creek
- NA - Not applicable
- NCWQS - North Carolina Water Quality Standard
- ND - Not detected
- NOAA - National Oceanic and Atmospheric Administration
- MCL - Federal Maximum Contaminant Level
- PAH - Polynuclear aromatic hydrocarbon
- UT - Unnamed Tributary

TABLE 4-3
SURFACE SOIL - POSITIVE DETECTION SUMMARY
SITE 44, JONES STREET DUMP
REMEDIAL INVESTIGATION, CTO-0303
MCAS, NEW RIVER, NORTH CAROLINA
TCL ORGANICS

LOCATION	44-GW01DW-00	44-GW04-00	44-GW05-00	44-OA-SB01-00	44-OA-SB02-00	44-OA-SB03-00
DATE SAMPLED	03/13/95	03/13/95	03/14/95	03/08/95	03/08/95	03/14/95
DEPTH	0-12"	0-12"	0-12"	0-12"	0-12"	0-12"
UNITS	UG/KG	UG/KG	UG/KG	UG/KG	UG/KG	UG/KG
VOLATILES						
ACETONE	13 U	12 U	13 U	12 U	12 U	13 U
SEMIVOLATILES						
BIS(2-CHLOROETHYL)ETHER	430 U	390 U	400 U	390 U	390 U	430 U
2,6-DINITROTOLUENE	430 U	390 U	400 U	390 U	380 J	430 U
BIS(2-ETHYLHEXYL)PHTHALATE	430 U	390 U	400 U	390 U	260 J	430 U
INDENO(1,2,3-CD)PYRENE	430 U	390 U	400 U	390 U	390 U	430 U
BENZO(G,H,I)PERYLENE	430 U	390 U	400 U	390 U	390 U	430 U
PESTICIDE/PCBS						
4,4'-DDE	4.3 U	3.9 UJ	4 U	4 U	4 U	80
4,4'-DDD	4.3 U	3.9 UJ	4 U	4 U	4 U	7.4 J
4,4'-DDT	4.3 U	3.9 UJ	4 U	4 U	4 U	45 J

UG/KG - microgram per kilogram
 J - value is estimated
 U - not detected
 UJ - not detected, value is estimated

TABLE 4-3
SURFACE SOIL - POSITIVE DETECTION SUMMARY
SITE 44, JONES STREET DUMP
REMEDIAL INVESTIGATION, CTO-0303
MCAS, NEW RIVER, NORTH CAROLINA
TCL ORGANICS

LOCATION	44-OA-SB04-00	44-OA-SB05-00	44-OA-SB06-00	44-WA-SB01-00	44-WA-SB02-00	44-WA-SB03-00
DATE SAMPLED	03/14/95	03/14/95	03/14/95	03/13/95	03/13/95	03/13/95
DEPTH	0-12"	0-12"	0-12"	0-12"	0-12"	0-12"
UNITS	UG/KG	UG/KG	UG/KG	UG/KG	UG/KG	UG/KG
VOLATILES						
ACETONE	13 U	19 UJ	13 U	12 U	12 U	24 U
SEMIVOLATILES						
BIS(2-CHLOROETHYL)ETHER	420 U	400 U	550 J	390 U	410 U	390 U
2,6-DINITROTOLUENE	420 U	400 U	420 U	390 U	410 U	390 U
BIS(2-ETHYLHEXYL)PHTHALATE	420 U	400 U	420 U	390 U	410 U	390 U
INDENO(1,2,3-CD)PYRENE	420 U	220 J	420 U	390 U	410 U	390 U
BENZO(G,H,I)PERYLENE	57 J	200 J	420 U	390 U	410 U	390 U
PESTICIDE/PCBS						
4,4'-DDE	50 J	140	10 J	3.9 UJ	4.1 U	3.9 U
4,4'-DDD	4.1 UJ	4 UJ	4.2 UJ	3.9 UJ	4.1 U	3.9 U
4,4'-DDT	19 J	25 J	4.6 J	3.9 UJ	4.1 U	3.9 U

UG/KG - microgram per kilogram
 J - value is estimated
 U - not detected
 UJ - not detected, value is estimated

TABLE 4-3
SURFACE SOIL - POSITIVE DETECTION SUMMARY
SITE 44, JONES STREET DUMP
REMEDIAL INVESTIGATION, CTO-0303
MCAS, NEW RIVER, NORTH CAROLINA
TCL ORGANICS

LOCATION	44-WA-SB04-00
DATE SAMPLED	03/13/95
DEPTH	0-12"
UNITS	UG/KG
VOLATILES	
ACETONE	13 J
SEMIVOLATILES	
BIS(2-CHLOROETHYL)ETHER	400 U
2,6-DINITROTOLUENE	400 U
BIS(2-ETHYLHEXYL)PHTHALATE	400 U
INDENO(1,2,3-CD)PYRENE	400 U
BENZO(G,H,I)PERYLENE	400 U
PESTICIDE/PCBS	
4,4'-DDE	4 U
4,4'-DDD	4 U
4,4'-DDT	4 U

UG/KG - microgram per kilogram
 J - value is estimated
 U - not detected
 UJ - not detected, value is estimated

TABLE 4-4
 SURFACE SOIL - POSITIVE DETECTION SUMMARY
 SITE 44, JONES STREET DUMP
 REMEDIAL INVESTIGATION, CTO-0303
 MCAS, NEW RIVER, NORTH CAROLINA
 TAL METALS

LOCATION	44-GW01DW-00	44-GW04-00	44-GW05-00	44-OA-SB01-00	44-OA-SB02-00	44-OA-SB03-00
DATE SAMPLED	03/13/95	03/13/95	03/14/95	03/08/95	03/08/95	03/14/95
DEPTH	0-12"	0-12"	0-12"	0-12"	0-12"	0-12"
UNITS	MG/KG	MG/KG	MG/KG	MG/KG	MG/KG	MG/KG
ANALYTES						
ALUMINUM, TOTAL	10100	11300	14100	11800	3520	4780
ARSENIC, TOTAL	2.1 J	4.6 J	1.4 J	3.4	0.84	1.9 J
BARIUM, TOTAL	21.7	18.7	18.1	19.9	8.3	26.2
CALCIUM, TOTAL	2390	1390	111	5800 J	343 J	2360
CHROMIUM, TOTAL	13.2	14.5	16.4	16.4	4.4 U	6.7
COBALT, TOTAL	0.59 U	0.61	1.2	1.3	0.62 U	1 U
COPPER, TOTAL	2.6	2.3	1.1	3	0.81 U	910
IRON, TOTAL	15400	12000	13100	11300 J	2430 J	4590
LEAD, TOTAL	10.7	13.9	8.5	10.3 U	5.7 U	31.7 J
MAGNESIUM, TOTAL	343	399	401	546	115	230
MANGANESE, TOTAL	6.2	9	6.9	8.7	8.2	44.2
NICKEL, TOTAL	1.3	1.6	2.5 U	1.9	1.3	2.8
POTASSIUM, TOTAL	227	293	292	339	109	187
SELENIUM, TOTAL	0.52 UJ	0.55 UJ	0.72	0.41	0.28 U	0.43 U
SODIUM, TOTAL	32.4	17.2	34.6	44.5	7.3 U	22.7
VANADIUM, TOTAL	23.3	28.6	27	24.3	7	11.1
ZINC, TOTAL	3.5	4.3	4.5	5.2	2.8	156

MG/KG - milligram per kilogram
 J - value is estimated
 U - not detected
 UJ - not detected, value is estimated

TABLE 4-4
 SURFACE SOIL - POSITIVE DETECTION SUMMARY
 SITE 44, JONES STREET DUMP
 REMEDIAL INVESTIGATION, CTO-0303
 MCAS, NEW RIVER, NORTH CAROLINA
 TAL METALS

LOCATION	44-OA-SB04-00	44-OA-SB05-00	44-OA-SB06-00	44-WA-SB01-00	44-WA-SB02-00	44-WA-SB03-00
DATE SAMPLED	03/14/95	03/14/95	03/14/95	03/13/95	03/13/95	03/13/95
DEPTH	0-12"	0-12"	0-12"	0-12"	0-12"	0-12"
UNITS	MG/KG	MG/KG	MG/KG	MG/KG	MG/KG	MG/KG
ANALYTES						
ALUMINUM, TOTAL	5900	7990	5470	6610	8740	7110
ARSENIC, TOTAL	2.6	1.4	0.79 J	2 J	4.9 J	1.7 J
BARIUM, TOTAL	15.7	20.9	11.7	12.7	20.5	14
CALCIUM, TOTAL	245	2160	163	1550	2150	5130
CHROMIUM, TOTAL	8.7	10.8	4.2	8.8	12.3	10
COBALT, TOTAL	0.49 U	0.71	0.69 U	0.38 U	0.55 U	0.69 U
COPPER, TOTAL	2.8	2.3	0.86	1.9	1.2	1
IRON, TOTAL	5420	9060	2660	7410	10500	7300
LEAD, TOTAL	14.9	8.3	12.5 J	5.9	13.6 J	7.2 J
MAGNESIUM, TOTAL	215	289	143	212	297	317
MANGANESE, TOTAL	5.1	31	6	4.9	5.3	8.1
NICKEL, TOTAL	1.3	1.4	2.5 U	0.97	1.9	2.5 U
POTASSIUM, TOTAL	286	258	156 U	170	197	208
SELENIUM, TOTAL	0.3 U	0.43	0.44 U	0.42 UJ	0.31 U	0.31 J
SODIUM, TOTAL	15 U	24.2 U	16.6	17.6 U	31.3	48.3
VANADIUM, TOTAL	14.9	16.4	9.7	15.5	20.9	14.6
ZINC, TOTAL	7.4	22.4	4.5	2.7	3.7	2.8

MG/KG - milligram per kilogram
 J - value is estimated
 U - not detected
 UJ - not detected, value is estimated

TABLE 4-4
SURFACE SOIL - POSITIVE DETECTION SUMMARY
SITE 44, JONES STREET DUMP
REMEDIAL INVESTIGATION, CTO-0303
MCAS, NEW RIVER, NORTH CAROLINA
TAL METALS

LOCATION	44-WA-SB04-00
DATE SAMPLED	03/13/95
DEPTH	0-12"
UNITS	MG/KG

ANALYTES	
ALUMINUM, TOTAL	13100
ARSENIC, TOTAL	2.9
BARIUM, TOTAL	20.4
CALCIUM, TOTAL	2620
CHROMIUM, TOTAL	15.5
COBALT, TOTAL	0.57
COPPER, TOTAL	2.1
IRON, TOTAL	9670
LEAD, TOTAL	12.5
MAGNESIUM, TOTAL	482
MANGANESE, TOTAL	6.4
NICKEL, TOTAL	2.1
POTASSIUM, TOTAL	315
SELENIUM, TOTAL	0.33
SODIUM, TOTAL	57.1
VANADIUM, TOTAL	25.5
ZINC, TOTAL	4.4

MG/KG - milligram per kilogram
 J - value is estimated
 U - not detected
 UJ - not detected, value is estimated

TABLE 4-5
SUBSURFACE SOIL - POSITIVE DETECTION SUMMARY
SITE 44, JONES STREET DUMP
REMEDIAL INVESTIGATION, CTO-0303
MCAS, NEW RIVER, NORTH CAROLINA
TCL ORGANICS

LOCATION	44-GW01DW-03	44-GW04-04	44-GW05-03	44-OA-SB01-04	44-OA-SB02-03	44-OA-SB03-01
DATE SAMPLED	03/13/95	03/13/95	03/14/95	03/08/95	03/08/95	03/14/95
DEPTH	5-7'	7-9'	5-7'	7-9'	5-7'	1-3'
UNITS	UG/KG	UG/KG	UG/KG	UG/KG	UG/KG	UG/KG
VOLATILES						
ACETONE	72 U	12 U	13 UJ	61	12 U	11 U
SEMIVOLATILES						
BIS(2-ETHYLHEXYL)PHTHALATE	430 U	390 U	380 U	410 U	83 J	380 U
INDENO(1,2,3-CD)PYRENE	430 U	390 U	55 J	410 U	390 U	380 U
BENZO(G,H,I)PERYLENE	430 U	390 U	62 J	410 U	390 U	380 U
PESTICIDE/PCBS						
4,4'-DDE	370 J	3.9 UJ	3.7 UJ	4	3.9 U	3.7 UJ
4,4'-DDD	2500	3.9 UJ	3.7 UJ	5.6	3.9 U	3.7 UJ
4,4'-DDT	150 J	3.9 UJ	3.7 UJ	4 U	3.9 U	3.7 UJ

UG/KG - microgram per kilogram
 J - value is estimated
 U - not detected
 UJ - not detected, value is estimated

TABLE 4-5
SUBSURFACE SOIL - POSITIVE DETECTION SUMMARY
SITE 44, JONES STREET DUMP
REMEDIAL INVESTIGATION, CTO-0303
MCAS, NEW RIVER, NORTH CAROLINA
TCL ORGANICS

LOCATION	44-OA-SB04-02	44-OA-SB05-02	44-OA-SB06-02	44-WA-SB01-03	44-WA-SB02-03	44-WA-SB03-03
DATE SAMPLED	03/14/95	03/14/95	03/14/95	03/13/95	03/13/95	03/13/95
DEPTH	3-5'	3-5'	3-5'	5-7'	5-7'	5-7'
UNITS	UG/KG	UG/KG	UG/KG	UG/KG	UG/KG	UG/KG
VOLATILES						
ACETONE	20 UJ	18 UJ	12 U	53 U	NA	33 U
SEMIVOLATILES						
BIS(2-ETHYLHEXYL)PHTHALATE	390 U	370 U	390 U	390 U	370 U	400 U
INDENO(1,2,3-CD)PYRENE	390 U	130 J	390 U	390 U	370 U	400 U
BENZO(G,H,I)PERYLENE	40 J	120 J	390 U	390 U	370 U	400 U
PESTICIDE/PCBS						
4,4'-DDE	3.9 UJ	3.7 UJ	4 UJ	3.8 UJ	3.8 U	3.2 J
4,4'-DDD	3.9 UJ	3.7 UJ	4 UJ	3.8 UJ	3.8 U	8
4,4'-DDT	3.9 UJ	3.7 UJ	4 UJ	3.8 UJ	3.8 U	4 U

UG/KG - microgram per kilogram
 J - value is estimated
 U - not detected
 UJ - not detected, value is estimated

TABLE 4-5
SUBSURFACE SOIL - POSITIVE DETECTION SUMMARY
SITE 44, JONES STREET DUMP
REMEDIAL INVESTIGATION, CTO-0303
MCAS, NEW RIVER, NORTH CAROLINA
TCL ORGANICS

LOCATION	44-WA-SB04-03
DATE SAMPLED	03/13/95
DEPTH	5-7'
UNITS	UG/KG
VOLATILES	
ACETONE	92 UJ
SEMIVOLATILES	
BIS(2-ETHYLHEXYL)PHTHALATE	390 U
INDENO(1,2,3-CD)PYRENE	390 U
BENZO(G,H,I)PERYLENE	390 U
PESTICIDE/PCBS	
4,4'-DDE	3.9 J
4,4'-DDD	21 J
4,4'-DDT	3.9 UJ

UG/KG - microgram per kilogram
 J - value is estimated
 U - not detected
 UJ - not detected, value is estimated

TABLE 4-6
 SUBSURFACE SOIL - POSITIVE DETECTION SUMMARY
 SITE 44, JONES STREET DUMP
 REMEDIAL INVESTIGATION, CTO-0303
 MCAS, NEW RIVER, NORTH CAROLINA
 TAL METALS

LOCATION	44-GW01DW-03	44-GW04-04	44-GW05-03	44-OA-SB01-04	44-OA-SB02-03	44-OA-SB03-01
DATE SAMPLED	03/13/95	03/13/95	03/14/95	03/08/95	03/08/95	03/14/95
DEPTH	5-7'	7-9'	5-7'	7-9'	5-7'	1-3'
UNITS	MG/KG	MG/KG	MG/KG	MG/KG	MG/KG	MG/KG
ANALYTES						
ALUMINUM, TOTAL	6020	4300	2240	7300	9940	1850
ARSENIC, TOTAL	1.3 J	0.51 J	0.32 U	1.2	1.1	0.31 J
BARIUM, TOTAL	11.9	6.8	5.7	10.7	10.5	2.6 U
CALCIUM, TOTAL	3880	268	15.6	702 J	40.7 J	93.9
CHROMIUM, TOTAL	9.2	5.3	2.4	8.3	9.1	2.5
COPPER, TOTAL	2.9	0.93 U	0.7	1.1	0.94 U	0.42
IRON, TOTAL	8270	4810	1480	4790 J	4200 J	2690
LEAD, TOTAL	9.1	7	4.3	8.5 U	7.4 U	4.5 J
MAGNESIUM, TOTAL	236	87.9	57.1	254	250	43.2
MANGANESE, TOTAL	7.2	1.9	1.3	9.1	4.2	1.5
NICKEL, TOTAL	15.8	0.97 U	0.71 U	1.3	1.7	1.8 U
POTASSIUM, TOTAL	221	77	53	261	173	113 U
SODIUM, TOTAL	28	10.4 U	6.3 U	20.3 U	15.4 U	5.3
VANADIUM, TOTAL	19.2	8.4	3.5	11.6	12.2	3.6
ZINC, TOTAL	4.7	1	1.5	2.7	2.5	0.94

MG/KG - milligram per kilogram
 J - value is estimated
 U - not detected
 UJ - not detected, value is estimated

TABLE 4-6
 SUBSURFACE SOIL - POSITIVE DETECTION SUMMARY
 SITE 44, JONES STREET DUMP
 REMEDIAL INVESTIGATION, CTO-0303
 MCAS, NEW RIVER, NORTH CAROLINA
 TAL METALS

LOCATION	44-OA-SB04-02	44-OA-SB05-02	44-OA-SB06-02	44-WA-SB01-03	44-WA-SB02-03	44-WA-SB03-03
DATE SAMPLED	03/14/95	03/14/95	03/14/95	03/13/95	03/13/95	03/13/95
DEPTH	3-5'	3-5'	3-5'	5-7'	5-7'	5-7'
UNITS	MG/KG	MG/KG	MG/KG	MG/KG	MG/KG	MG/KG
ANALYTES						
ALUMINUM, TOTAL	3330	5030	5550	1520	6790	6500
ARSENIC, TOTAL	0.36 U	0.48	1.3 J	0.4 UJ	0.41 J	1 J
BARIUM, TOTAL	5	9.4	8.7	3.4	13.7	13.3
CALCIUM, TOTAL	31.1	309	22.4	161	379	168
CHROMIUM, TOTAL	3.3	5.8	9.1	2.1	6.2	9.5
COPPER, TOTAL	0.66 U	0.9	0.56	0.82 U	0.78	0.78
IRON, TOTAL	1900	1870	4040	389	3690	5680
LEAD, TOTAL	3.7	2.9	8.5 J	1.4	5.9 J	5.9 J
MAGNESIUM, TOTAL	70.3	181	117	65.9	194	218
MANGANESE, TOTAL	1.5	5.3	1.7	2.7	9.3	6.1
NICKEL, TOTAL	0.7 U	3.1	2.5 U	0.86 U	2.2 U	4.9
POTASSIUM, TOTAL	91.4	176	168	104	233	151 U
SODIUM, TOTAL	12.1 U	12.8 U	32	3.9	31.4	30.5
VANADIUM, TOTAL	3.8	7.3	8.4	3.2	10.1	14.2
ZINC, TOTAL	0.79	2.3	0.88 U	0.76	1.8	2.6

MG/KG - milligram per kilogram
 J - value is estimated
 U - not detected
 UJ - not detected, value is estimated

TABLE 4-6
SUBSURFACE SOIL - POSITIVE DETECTION SUMMARY
SITE 44, JONES STREET DUMP
REMEDIAL INVESTIGATION, CTO-0303
MCAS, NEW RIVER, NORTH CAROLINA
TAL METALS

LOCATION	44-WA-SB04-03
DATE SAMPLED	03/13/95
DEPTH	5-7'
UNITS	MG/KG
ANALYTES	
ALUMINUM, TOTAL	6210
ARSENIC, TOTAL	2.5
BARIUM, TOTAL	11.9
CALCIUM, TOTAL	1080
CHROMIUM, TOTAL	6.2
COPPER, TOTAL	1.1
IRON, TOTAL	3210
LEAD, TOTAL	7
MAGNESIUM, TOTAL	231
MANGANESE, TOTAL	7.6
NICKEL, TOTAL	2.3
POTASSIUM, TOTAL	203
SODIUM, TOTAL	22 U
VANADIUM, TOTAL	9.4
ZINC, TOTAL	10.8

MG/KG - milligram per kilogram
 J - value is estimated
 U - not detected
 UJ - not detected, value is estimated

TABLE 4-7
GROUNDWATER - POSITIVE DETECTION SUMMARY
SITE 44, JONES STREET DUMP
REMEDIAL INVESTIGATION, CIO-0303
MCAS, NEW RIVER, NORTH CAROLINA
TCL ORGANICS

LOCATION	44-GW01-01	44-GW01DW-01	44-GW02-01	44-GW03-01	44-GW04-01	44-GW05-01
DATE SAMPLED	04/09/95	04/09/95	04/10/95	04/10/95	04/08/95	04/09/95
UNITS	UG/L	UG/L	UG/L	UG/L	UG/L	UG/L
VOLATILES						
VINYL CHLORIDE	10 U	10 U	10 U	10 U	10 U	10 U
1,2-DICHLOROETHENE (TOTAL)	10 U	10 U	10 U	10 U	10 U	10 U
TRICHLOROETHENE	10 U	10 U	10 U	10 U	10 U	10 U
TETRACHLOROETHENE	10 U	10 U	10 U	1 J	10 U	10 U
SEMIVOLATILES						
NAPHTHALENE	10 U	10 U	10 U	71	10 U	10 U
2-METHYLNAPHTHALENE	10 U	10 U	10 U	4 J	10 U	10 U
ACENAPHTHENE	10 U	10 U	10 U	13	10 U	10 U
DIBENZOFURAN	10 U	10 U	10 U	6 J	10 U	10 U
FLUORENE	10 U	10 U	10 U	7 J	10 U	10 U
PHENANTHRENE	10 U	10 U	10 U	7 J	10 U	10 U
CARBAZOLE	10 U	10 U	10 U	4 J	10 U	10 U
BIS(2-ETHYLHEXYL)PHTHALATE	10 U	10 U	2 J	10 U	10 U	10 U

UG/L - microgram per liter
J - value is estimated
U - not detected

TABLE 4-7
GROUNDWATER - POSITIVE DETECTION SUMMARY
SITE 44, JONES STREET DUMP
REMEDIAL INVESTIGATION, CTO-0303
MCAS, NEW RIVER, NORTH CAROLINA
TCL ORGANICS

LOCATION	44-GW06-01	44-GW06DW-01	44-TW01-01
DATE SAMPLED	04/08/95	04/08/95	04/10/95
UNITS	UG/L	UG/L	UG/L
VOLATILES			
VINYL CHLORIDE	10 U	10 U	10 J
1,2-DICHLOROETHENE (TOTAL)	10 U	10 U	15
TRICHLOROETHENE	10 U	10 U	1 J
TETRACHLOROETHENE	10 U	10 U	10 U
SEMIVOLATILES			
NAPHTHALENE	10 U	11 U	10 U
2-METHYLNAPHTHALENE	10 U	11 U	10 U
ACENAPHTHENE	10 U	11 U	10 U
DIBENZOFURAN	10 U	11 U	10 U
FLUORENE	10 U	11 U	10 U
PHENANTHRENE	10 U	11 U	10 U
CARBAZOLE	10 U	11 U	10 U
BIS(2-ETHYLHEXYL)PHTHALATE	10 U	11 U	10 U

UG/L - microgram per liter
J - value is estimated
U - not detected

**TABLE 4-8
GROUNDWATER - POSITIVE DETECTION SUMMARY
SITE 44, JONES STREET DUMP
REMEDIAL INVESTIGATION, CTO-0303
MCAS, NEW RIVER, NORTH CAROLINA
TAL METALS**

LOCATION	44-GW01-01	44-GW01DW-01	44-GW02-01	44-GW03-01	44-GW04-01	44-GW05-01
DATE SAMPLED	04/09/95	04/09/95	04/10/95	04/10/95	04/08/95	04/09/95
UNITS	UG/L	UG/L	UG/L	UG/L	UG/L	UG/L
ANALYTES						
ALUMINUM, TOTAL	25.9 U	21.2 U	2820	26.1 U	169 U	147 U
ARSENIC, TOTAL	1.7	1.7 U	1.7 U	1.7 U	2.8	1.7 U
BARIUM, TOTAL	62.5 J	7.4 U	19.3 U	100	56.6 J	15.6 U
CALCIUM, TOTAL	70000	48200	1290	98300	92600	29900
CHROMIUM, TOTAL	4.1 U	4.1 U	6.9	3.8 U	4.1 U	4.1 U
COBALT, TOTAL	3.4 U	3.4 U	3.4 U	2.6 U	3.5	3.4 U
IRON, TOTAL	65500	285	3160	42000	72900	1400
LEAD, TOTAL	0.6 U	0.6 U	1.4	0.8 U	0.6 U	0.6 U
MAGNESIUM, TOTAL	8720	4370	880	11900	7510	2410
MANGANESE, TOTAL	192	60.6	12.6 U	217	241	65.2
POTASSIUM, TOTAL	2930	5850	2840	8160	2620	2480
SELENIUM, TOTAL	1.8 U	1.8 U	1.8 U	1.8 U	1.8 U	2
SODIUM, TOTAL	5370	74100	4890	7220	5260	6260
ZINC, TOTAL	6 U	6 U	7	2.2 U	16.4	6.8

UG/L - microgram per liter
J - value is estimated
U - not detected

**TABLE 4-8
GROUNDWATER - POSITIVE DETECTION SUMMARY
SITE 44, JONES STREET DUMP
REMEDIAL INVESTIGATION, CTO-0303
MCAS, NEW RIVER, NORTH CAROLINA
TAL METALS**

LOCATION	44-GW06-01	44-GW06DW-01	44-TW01-01
DATE SAMPLED	04/08/95	04/08/95	04/10/95
UNITS	UG/L	UG/L	UG/L
ANALYTES			
ALUMINUM, TOTAL	374	21.2 U	668
ARSENIC, TOTAL	1.7 U	1.7 U	1.7 U
BARIUM, TOTAL	49.9 J	4.4 U	30.8 J
CALCIUM, TOTAL	23300	57000	44500
CHROMIUM, TOTAL	4.1 U	4.1 U	4.1 U
COBALT, TOTAL	3.4 U	3.4 U	3.4 U
IRON, TOTAL	1100	743	1060
LEAD, TOTAL	0.6 U	0.6 U	1.3
MAGNESIUM, TOTAL	3140	4060	2510
MANGANESE, TOTAL	44.5	32.7	21.6
POTASSIUM, TOTAL	1340	6590	1790
SELENIUM, TOTAL	1.8 U	1.8 U	1.8 U
SODIUM, TOTAL	14700	49100	21800
ZINC, TOTAL	11.7	6 U	6 U

UG/L - microgram per liter
J - value is estimated
U - not detected

TABLE 4-9
GROUNDWATER - POSITIVE DETECTION SUMMARY
SITE 44, JONES STREET DUMP
REMEDIAL INVESTIGATION, CTO-0303
MCAS, NEW RIVER, NORTH CAROLINA
TAL DISSOLVED METALS

LOCATION	44-GW01D-01
DATE SAMPLED	04/09/95
DEPTH	N/A
UNITS	UG/L
ANALYTES	
BARIUM, SOLUBLE	64.9 J
CALCIUM, SOLUBLE	74000
IRON, SOLUBLE	68400
MAGNESIUM, SOLUBLE	8980
MANGANESE, SOLUBLE	198
POTASSIUM, SOLUBLE	3170
SODIUM, SOLUBLE	5460

UG/L - microgram per liter
 J - value is estimated

TABLE 4-10
SURFACE WATER - POSITIVE DETECTION SUMMARY
SITE 44, JONES STREET DUMP
REMEDIAL INVESTIGATION, CTO-0303
MCAS, NEW RIVER, NORTH CAROLINA
TCL ORGANICS

LOCATION	44-EC-SW01	44-EC-SW02	44-EC-SW03	44-EC-SW04	44-EC-SW05	44-UT-SW01
DATE SAMPLED	05/03/95	05/03/95	05/03/95	05/03/95	05/03/95	05/03/95
UNITS	UG/L	UG/L	UG/L	UG/L	UG/L	UG/L
VOLATILES						
VINYL CHLORIDE	24	15	8 J	10 U	10 U	10 U
ACETONE	13	10 U	10 U	10 U	10	10 U
1,2-DICHLOROETHENE (TOTAL)	150	100	59	24	18	10 U
TRICHLOROETHENE	66	54	34	12	7 J	10 U
1,1,2,2-TETRACHLOROETHANE	32	32	34	7 J	5 J	10 U
SEMIVOLATILES						
PHENOL	11 U	10 U	10 U	10 U	10 U	1 J
BIS(2-ETHYLHEXYL)PHTHALATE	1 J	10 U	1 J	1 J	3 J	10 U

UG/L - microgram per liter
 J - value is estimated
 U - not detected

TABLE 4-10
SURFACE WATER - POSITIVE DETECTION SUMMARY
SITE 44, JONES STREET DUMP
REMEDIAL INVESTIGATION, CTO-0303
MCAS, NEW RIVER, NORTH CAROLINA
TCL ORGANICS

LOCATION	44-UT-SW02	44-UT-SW03
DATE SAMPLED	05/03/95	05/03/95
UNITS	UG/L	UG/L
VOLATILES		
VINYL CHLORIDE	10 U	10 U
ACETONE	10 U	11
1,2-DICHLOROETHENE (TOTAL)	10 U	5 J
TRICHLOROETHENE	10 U	2 J
1,1,2,2-TETRACHLOROETHANE	10 U	10 U
SEMIVOLATILES		
PHENOL	10 U	10 U
BIS(2-ETHYLHEXYL)PHTHALATE	1 J	1 J

UG/L - microgram per liter
 J - value is estimated
 U - not detected

TABLE 4-11
SURFACE WATER - POSITIVE DETECTION SUMMARY
SUPPLEMENTAL SAMPLING EVENT
SITE 44, JONES STREET DUMP
REMEDIAL INVESTIGATION, CTO-0303
MCAS, NEW RIVER, NORTH CAROLINA
TCL VOLATILES

LOCATION	44-EC-SW01-02	44-EC-SW02-02	44-EC-SW03-02	44-EC-SW04-02	44-EC-SW06-01	44-EC-SW07-01
DATE SAMPLED	09/28/95	09/28/95	09/28/95	09/28/95	09/28/95	09/28/95
UNITS	UG/L	UG/L	UG/L	UG/L	UG/L	UG/L
VOLATILES						
VINYL CHLORIDE	16	7 J	10 U	10 U	25	15
1,1-DICHLOROETHENE	1 J	10 U	10 U	10 U	2 J	10 U
1,2-DICHLOROETHENE (TOTAL)	93 J	51 J	42 J	21 J	110 J	68 J
TRICHLOROETHENE	22	11	10	5 J	22	4 J
1,1,2-TRICHLOROETHANE	10 U	10 U	10 U	10 U	10 U	10 U
1,1,2,2-TETRACHLOROETHANE	26	19	16	8 J	32	32

UG/L - microgram per liter
 J - value is estimated
 U - not detected

TABLE 4-11
SURFACE WATER - POSITIVE DETECTION SUMMARY
SUPPLEMENTAL SAMPLING EVENT
SITE 44, JONES STREET DUMP
REMEDIAL INVESTIGATION, CTO-0303
MCAS, NEW RIVER, NORTH CAROLINA
TCL VOLATILES

LOCATION	44-EC-SW08-01	44-EC-SW09-01
DATE SAMPLED	09/28/95	09/28/95
UNITS	UG/L	UG/L
VOLATILES		
VINYL CHLORIDE	38	10 U
1,1-DICHLOROETHENE	1 J	10 U
1,2-DICHLOROETHENE (TOTAL)	120 J	2 J
TRICHLOROETHENE	7 J	4 J
1,1,2-TRICHLOROETHANE	1 J	10 U
1,1,2,2-TETRACHLOROETHANE	42	10 U

UG/L - microgram per liter
 J - value is estimated
 U - not detected

TABLE 4-12
 SURFACE WATER - POSITIVE DETECTION SUMMARY
 SITE 44, JONES STREET DUMP
 REMEDIAL INVESTIGATION, CTO-0303
 MCB, CAMP LEJEUNE, NORTH CAROLINA
 TAL METALS

LOCATION	44-EC-SW01	44-EC-SW02	44-EC-SW03	44-EC-SW04	44-EC-SW05	44-UT-SW01
DATE SAMPLED	05/03/95	05/03/95	05/03/95	05/03/95	05/03/95	05/03/95
UNITS	UG/L	UG/L	UG/L	UG/L	UG/L	UG/L
ANALYTES						
ALUMINUM, TOTAL	353	416	206	509	232	132 U
BARIUM, TOTAL	26.2	24.4	23.7	27.1	25.5	16.5 U
CALCIUM, TOTAL	54700	54000	53400	54600	55500	36500
COPPER, TOTAL	1.8 U	2.2	1.9	1.9	2.3	2.3
IRON, TOTAL	1940	1840	1700	1980	1320	1280 J
LEAD, TOTAL	5.7 U	6.2 U	11.2	8.6 U	3.4 U	0.83 J
MAGNESIUM, TOTAL	2710	2550	2530	11300	23300	5890
MANGANESE, TOTAL	231	74.9	74.7	89.8	80	47.2
NICKEL, TOTAL	21.1	15.3	7.7	5.4 U	5.4 U	10.9 U
POTASSIUM, TOTAL	3950	3560	3390	6170	10000	5210 J
SODIUM, TOTAL	17600	16200	16800	90500	195000	51200
VANADIUM, TOTAL	29.9	20	12.7	7.4 U	6 U	2 U
ZINC, TOTAL	41.9 J	61.3 J	17.3 J	26.5 J	16.8 J	12 U

UG/L - microgram per liter
 J - value is estimated
 U - not detected

TABLE 4-12
 SURFACE WATER - POSITIVE DETECTION SUMMARY
 SITE 44, JONES STREET DUMP
 REMEDIAL INVESTIGATION, CTO-0303
 MCB, CAMP LEJEUNE, NORTH CAROLINA
 TAL METALS

LOCATION	44-UT-SW02	44-UT-SW03
DATE SAMPLED	05/03/95	05/03/95
UNITS	UG/L	UG/L
ANALYTES		
ALUMINUM, TOTAL	122	140
BARIUM, TOTAL	14.5	18.2
CALCIUM, TOTAL	33500	39300
COPPER, TOTAL	2.2	2.3
IRON, TOTAL	1400	1170
LEAD, TOTAL	2.2 U	3.1 U
MAGNESIUM, TOTAL	4120	9420
MANGANESE, TOTAL	38.8	74.2
NICKEL, TOTAL	5.4 U	5.4 U
POTASSIUM, TOTAL	4590	6020
SODIUM, TOTAL	43000	81000
VANADIUM, TOTAL	9.4 U	11.7
ZINC, TOTAL	55.8 J	42.4 J

UG/L - microgram per liter
 J - value is estimated
 U - not detected

TABLE 4-13
SURFACE WATER - POSITIVE DETECTION SUMMARY
SITE 44, JONES STREET DUMP
REMEDIAL INVESTIGATION, CTO-0303
MCAS, NEW RIVER, NORTH CAROLINA
TAL DISSOLVED METALS

LOCATION	44-EC-DSW01	44-EC-DSW02	44-EC-DSW03	44-EC-DSW04	44-EC-DSW05	44-UT-DSW01
DATE SAMPLED	05/03/95	05/03/95	05/03/95	05/03/95	05/03/95	05/03/95
UNITS	UG/L	UG/L	UG/L	UG/L	UG/L	UG/L
ANALYTES						
ALUMINUM, SOLUBLE	21.9	25.2	15.7 U	15.7 U	15.7 U	21.2 U
BARIUM, SOLUBLE	21.2	21.2	21.3	21	22.4	15 U
CALCIUM, SOLUBLE	53800	52100	52300	51200	55500	37400
COPPER, SOLUBLE	1.8 U	1.9	1.9	1.8 U	1.8 U	1.8 U
IRON, SOLUBLE	454	493	501	326	268	654 J
LEAD, SOLUBLE	1.1 U	0.81 U	1.1 U	0.8 U	0.8 U	0.8 UJ
MAGNESIUM, SOLUBLE	2650	2470	2490	11500	24400	6030
MANGANESE, SOLUBLE	11	17.2	20.9	20.8	33.3	26.3
NICKEL, SOLUBLE	19.8	12.1	6.2	5.4 U	5.4 U	10.9 U
POTASSIUM, SOLUBLE	3840	3490	3420	6020	10300	4820 J
SODIUM, SOLUBLE	17600	16200	16900	92300	205000	52500
VANADIUM, SOLUBLE	11.6	8.4 U	5 U	2 U	3.5 U	2.5
ZINC, SOLUBLE	17.7 J	12.2 J	8.4 J	7.3 J	8 J	6 U

UG/L - microgram per liter
 J - value is estimated
 U - not detected

TABLE 4-13
 SURFACE WATER - POSITIVE DETECTION SUMMARY
 SITE 44, JONES STREET DUMP
 REMEDIAL INVESTIGATION, CTO-0303
 MCAS, NEW RIVER, NORTH CAROLINA
 TAL DISSOLVED METALS

LOCATION	44-UT-DSW02	44-UT-DSW03
DATE SAMPLED	05/03/95	05/03/95
UNITS	UG/L	UG/L
ANALYTES		
ALUMINUM, SOLUBLE	15.7 U	25.9
BARIUM, SOLUBLE	12.7	16
CALCIUM, SOLUBLE	33200	39700
COPPER, SOLUBLE	3.7	3
IRON, SOLUBLE	352	418
LEAD, SOLUBLE	41.8	0.8 U
MAGNESIUM, SOLUBLE	4080	9590
MANGANESE, SOLUBLE	6.5	29.7
NICKEL, SOLUBLE	5.4 U	5.4 U
POTASSIUM, SOLUBLE	4550	6070
SODIUM, SOLUBLE	42800	83400
VANADIUM, SOLUBLE	5.8 U	7.7 U
ZINC, SOLUBLE	8 J	24.3 J

UG/L - microgram per liter
 J - value is estimated
 U - not detected

TABLE 4-14
 SEDIMENT - POSITIVE DETECTION SUMMARY
 SITE 44, JONES STREET DUMP
 REMEDIAL INVESTIGATION, CTO-0303
 MCAS, NEW RIVER, NORTH CAROLINA
 TCL ORGANICS

LOCATION	44-EC-SD01-06	44-EC-SD01-612	44-EC-SD02-06	44-EC-SD02-612	44-EC-SD03-06	44-EC-SD03-612
DATE SAMPLED	05/04/95	05/04/95	05/04/95	05/04/95	05/04/95	05/04/95
DEPTH	0-6"	6-12"	0-6"	6-12"	0-6"	6-12"
UNITS	UG/KG	UG/KG	UG/KG	UG/KG	UG/KG	UG/KG
VOLATILES						
ACETONE	12 U	12 U	12 U	33	12 U	29
2-BUTANONE	12 U	12 U	12 U	13 U	12 U	12 U
SEMIVOLATILES						
PENTACHLOROPHENOL	980 U	740 J	1000 U	1100 U	1000 U	340 J
PHENANTHRENE	390 U	390 U	400 U	420 U	400 U	390 U
CARBAZOLE	390 U	390 U	400 U	420 U	400 U	390 U
FLUORANTHENE	390 U	390 U	400 U	95 J	400 U	390 U
PYRENE	390 U	390 U	400 U	81 J	400 U	390 U
BUTYLBENZYLPHTHALATE	390 U	390 U	400 U	420 U	400 U	390 U
BENZO(A)ANTHRACENE	390 U	390 U	400 U	420 U	400 U	390 U
CHRYSENE	44 J	390 U	400 U	50 J	400 U	390 U
BIS(2-ETHYLHEXYL)PHTHALATE	390 U	390 U	400 U	420 U	400 U	160 J
BENZO(B)FLUORANTHENE	66 J	390 U	400 U	52 J	400 U	390 U
BENZO(K)FLUORANTHENE	390 U	390 U	400 U	420 U	400 U	390 U
BENZO(A)PYRENE	390 U	390 U	400 U	420 U	400 U	390 U
BENZO(G,H,I)PERYLENE	390 U	390 U	400 U	420 U	400 U	390 U
PESTICIDE/PCBS						
ALDRIN	1.9 UJ	1.9 UJ	2 U	2.1 UJ	2 UJ	2 UJ
HEPTACHLOR EPOXIDE	1.9 UJ	1.9 UJ	2 U	2.1 UJ	2 UJ	2 UJ
4,4'-DDE	30 J	21 J	24 J	58 J	9.3 J	17 J
4,4'-DDD	81	34 J	66	120	23 J	35 J
4,4'-DDT	9 J	3.1 J	4.4 J	3.8 J	4.1 UJ	4 UJ
ALPHA-CHLORDANE	2.3 J	2.7 J	2	3.3 J	2 UJ	2.4 J
GAMMA-CHLORDANE	2.7 J	2.7 J	2.8	4.2 J	2 UJ	2.8 J

UG/KG - microgram per kilogram
 J - value is estimated
 NJ - estimated/tentative identification
 R - rejected
 U - not detected
 UJ - not detected, value is estimated

TABLE 4-14
SEDIMENT - POSITIVE DETECTION SUMMARY
SITE 44, JONES STREET DUMP
REMEDIAL INVESTIGATION, CTO-0303
MCAS, NEW RIVER, NORTH CAROLINA
TCL ORGANICS

LOCATION	44-EC-SD04-06	44-EC-SD04-612	44-EC-SD05-06	44-EC-SD05-612	44-UT-SD01-06	44-UT-SD01-612
DATE SAMPLED	05/04/95	05/04/95	05/04/95	05/04/95	05/04/95	05/04/95
DEPTH	0-6"	6-12"	0-6"	6-12"	0-6"	6-12"
UNITS	UG/KG	UG/KG	UG/KG	UG/KG	UG/KG	UG/KG
VOLATILES						
ACETONE	13 U	61	160	72	610 J	220
2-BUTANONE	13 U	13 U	14 U	14 U	200	51
SEMIVOLATILES						
PENTACHLOROPHENOL	1100 U	1000 U	1200 U	1200 U	1700 U	1900 U
PHENANTHRENE	430 U	420 U	470 U	77 J	680 U	750 U
CARBAZOLE	430 U	420 U	470 U	480 U	680 U	750 U
FLUORANTHENE	430 U	420 U	120 J	100 J	680 U	750 U
PYRENE	430 U	42 J	100 J	100 J	680 U	750 U
BUTYLBENZYLPHTHALATE	430 U	420 U	470 U	480 U	680 U	750 U
BENZO(A)ANTHRACENE	430 U	420 U	470 U	480 U	680 U	750 U
CHRYSENE	430 U	420 U	84 J	61 J	680 U	750 U
BIS(2-ETHYLHEXYL)PHTHALATE	430 U	420 U	470 U	530	680 U	750 U
BENZO(B)FLUORANTHENE	430 U	420 U	99 J	480 U	680 U	750 U
BENZO(K)FLUORANTHENE	430 U	420 U	470 U	480 U	680 U	750 U
BENZO(A)PYRENE	430 U	420 U	470 U	480 U	680 U	750 U
BENZO(G,H,I)PERYLENE	430 U	420 U	49 J	480 U	680 U	750 U
PESTICIDE/PCBS						
ALDRIN	2.2 R	2.1 UJ	2.3 UJ	2.4 UJ	3.5 U	3.7 U
HEPTACHLOR EPOXIDE	2.2 R	2.1 UJ	2.3 UJ	2.4 UJ	3.5 U	3.7 U
4,4'-DDE	20 J	21 J	56 J	150 J	20 J	25 J
4,4'-DDD	33 J	43 J	140	370	5.5 J	13 J
4,4'-DDT	2.6 J	2.5 J	6.5 J	130	6.9 UJ	7.5 UJ
ALPHA-CHLORDANE	2.6 J	2.9 J	6.1 J	14 J	3.5 U	3.7 U
GAMMA-CHLORDANE	3 J	3.3 J	6.5 J	16 J	3.5 U	3.7 U

UG/KG - microgram per kilogram
 J - value is estimated
 NJ - estimated/tentative identification
 R - rejected
 U - not detected
 UJ - not detected, value is estimated

TABLE 4-14
 SEDIMENT - POSITIVE DETECTION SUMMARY
 SITE 44, JONES STREET DUMP
 REMEDIAL INVESTIGATION, CTO-0303
 MCAS, NEW RIVER, NORTH CAROLINA
 TCL ORGANICS

LOCATION	44-UT-SD02-06	44-UT-SD02-612	44-UT-SD03-06	44-UT-SD03-612
DATE SAMPLED	05/04/95	05/04/95	05/04/95	05/04/95
DEPTH	0-6"	6-12"	0-6"	6-12"
UNITS	UG/KG	UG/KG	UG/KG	UG/KG
VOLATILES				
ACETONE	38	44	15	37
2-BUTANONE	14 U	16 U	13 U	13 U
SEMIVOLATILES				
PENTACHLOROPHENOL	1200 U	1300 U	1100 U	1100 U
PHENANTHRENE	65 J	69 J	49 J	250 J
CARBAZOLE	460 U	510 U	430 U	79 J
FLUORANTHENE	170 J	510 U	210 J	740
PYRENE	120 J	510 U	150 J	490
BUTYLBENZYLPHTHALATE	48 J	510 U	430 U	440 U
BENZO(A)ANTHRACENE	50 J	510 U	59 J	170 J
CHRYSENE	99 J	510 U	130 J	460
BIS(2-ETHYLHEXYL)PHTHALATE	570	510 U	560	870
BENZO(B)FLUORANTHENE	110 J	510 U	160 J	600
BENZO(K)FLUORANTHENE	49 J	510 U	160 J	200 J
BENZO(A)PYRENE	56 J	510 U	89 J	300 J
BENZO(G,H,I)PERYLENE	71 J	510 U	430 U	440 U
PESTICIDE/PCBS				
ALDRIN	2.3 UJ	2.6 UJ	2.1 R	2.6 J
HEPTACHLOR EPOXIDE	2.3 UJ	2.6 UJ	2.1 R	5.2 J
4,4'-DDE	110 J	310 J	9.9 J	15 J
4,4'-DDD	85	770	14 J	21 J
4,4'-DDT	3.7 J	3.1 J	4.3 R	4.3 R
ALPHA-CHLORDANE	5.1 NJ	2.6 NJ	5.6 J	7.8 J
GAMMA-CHLORDANE	5.1 J	3.6 J	6.9 J	9.5 J

UG/KG - microgram per kilogram
 J - value is estimated
 NJ - estimated/tentative identification
 R - rejected
 U - not detected
 UJ - not detected, value is estimated

TABLE 4-15
 SEDIMENT - POSITIVE DETECTION SUMMARY
 SITE 44, JONES STREET DUMP
 REMEDIAL INVESTIGATION, CTO-0303
 MCAS, NEW RIVER, NORTH CAROLINA
 TAL METALS

LOCATION	44-EC-SD01-06	44-EC-SD01-612	44-EC-SD02-06	44-EC-SD02-612	44-EC-SD03-06	44-EC-SD03-612
DATE SAMPLED	05/04/95	05/04/95	05/04/95	05/04/95	05/04/95	05/04/95
DEPTH	0-6"	6-12"	0-6"	6-12"	0-6"	6-12"
ANALYTES (MG/KG)						
ALUMINUM, TOTAL	1420 J	787 J	811 J	1020 J	556 J	795
ARSENIC, TOTAL	0.8 J	0.45 J	0.32 U	0.59 J	0.29 U	0.36 U
BARIUM, TOTAL	7	5.1	7.7	7.1	4.9	5.5
BERYLLIUM, TOTAL	0.11 U	0.11	0.1 U	0.07 U	0.07 U	0.06 U
CADMIUM, TOTAL	0.7 U	0.71 U	0.79 U	0.91 U	0.85 U	0.83 U
CALCIUM, TOTAL	40000	33500	15600	9910	4190	7850
CHROMIUM, TOTAL	3.9	3.2	3.1	3	2.6	2.8
COBALT, TOTAL	0.59 U	0.26 U	0.95 U	0.54 U	0.56 U	0.48
COPPER, TOTAL	2.2	2.4	2.9	5.5	2	2.2
IRON, TOTAL	3380	1320	1100	1340	613	1040
LEAD, TOTAL	15.2 J	13.6 J	9.3 J	24.9 J	8.4 J	14.2
MAGNESIUM, TOTAL	637	534	288	171	95.8	156
MANGANESE, TOTAL	10.1	7	4.5	3.3	2	3.4
NICKEL, TOTAL	1.7	1.1	2.1	1.9	1.2	1.2 U
POTASSIUM, TOTAL	49.5 U	53.5 U	71.5 U	58.2 U	56.3 U	60.2
SELENIUM, TOTAL	0.3 U	0.28 U	0.33 U	0.34 U	0.31 U	0.38 U
SILVER, TOTAL	0.34 U	0.35 U	0.38 U	0.44 U	0.42 U	0.41 U
SODIUM, TOTAL	90	96.1	58.7	35.6	34.2	42.7
VANADIUM, TOTAL	7.8	5.3	3.4	4.4	1.9	3.2
ZINC, TOTAL	25	19.2	21.6	26	18.4	23.3

MG/KG - milligram per kilogram
 J - value is estimated
 U - not detected

TABLE 4-15
 SEDIMENT - POSITIVE DETECTION SUMMARY
 SITE 44, JONES STREET DUMP
 REMEDIAL INVESTIGATION, CTO-0303
 MCAS, NEW RIVER, NORTH CAROLINA
 TAL METALS

LOCATION	44-EC-SD04-06	44-EC-SD04-612	44-EC-SD05-06	44-EC-SD05-612	44-UT-SD01-06	44-UT-SD01-612
DATE SAMPLED	05/04/95	05/04/95	05/04/95	05/04/95	05/04/95	05/04/95
DEPTH	0-6"	6-12"	0-6"	6-12"	0-6"	6-12"
ANALYTES (MG/KG)						
ALUMINUM, TOTAL	934 J	841 J	1420 J	2650 J	10700 J	12200 J
ARSENIC, TOTAL	0.29 U	0.33 U	0.75 J	0.83 J	1.1	1.1
BARIUM, TOTAL	6.9	8.9	9	13	41.5	49.5
BERYLLIUM, TOTAL	0.06 U	0.07 U	0.08 U	0.17	0.22 U	0.25 U
CADMIUM, TOTAL	0.8 U	0.96 U	0.99 U	1.2	1.4 U	1.6 U
CALCIUM, TOTAL	3140	4650	3540	5490	5140	5840
CHROMIUM, TOTAL	3.9	2.8	4.5	8.8	10	11.1
COBALT, TOTAL	0.7 U	0.58 U	0.88 U	0.94 U	0.69 U	0.93 U
COPPER, TOTAL	3.8	3.7	4.9	7.7	1.9	2.8
IRON, TOTAL	1540	1490	1940	5290	5340	5830
LEAD, TOTAL	25.4 J	16.3 J	43.5 J	34.6 J	14.7 J	14.1 J
MAGNESIUM, TOTAL	116	124	246	250	383	588
MANGANESE, TOTAL	2.9	2.6	5.5	15.3	15.9	15.1
NICKEL, TOTAL	2.6	2.1	2.6	4	2.8	3.9
POTASSIUM, TOTAL	55.9 U	53.9 U	96.8 U	123	275	299
SELENIUM, TOTAL	0.3 U	0.35 U	0.38 U	0.47	1	1.4
SILVER, TOTAL	0.39 U	0.47 U	0.51	0.53 U	0.7 U	0.8 U
SODIUM, TOTAL	34.4	30.3	185	71.8	107	224
VANADIUM, TOTAL	4.3	4.3	6	9.2	13.7	15.1
ZINC, TOTAL	30.2	28.6	144	41.7	9	6.3

MG/KG - milligram per kilogram
 J - value is estimated
 U - not detected

TABLE 4-15
 SEDIMENT - POSITIVE DETECTION SUMMARY
 SITE 44, JONES STREET DUMP
 REMEDIAL INVESTIGATION, CTO-0303
 MCAS, NEW RIVER, NORTH CAROLINA
 TAL METALS

LOCATION	44-UT-SD02-06	44-UT-SD02-612	44-UT-SD03-06	44-UT-SD03-612
DATE SAMPLED	05/04/95	05/04/95	05/04/95	05/04/95
DEPTH	0-6"	6-12"	0-6"	6-12"
ANALYTES (MG/KG)				
ALUMINUM, TOTAL	2670 J	7830 J	1070 J	1110 J
ARSENIC, TOTAL	1.4	0.8	0.38	0.34
BARIUM, TOTAL	8.3	16	6.4	5.5
BERYLLIUM, TOTAL	0.08 U	0.17 U	0.06 U	0.6 U
CADMIUM, TOTAL	1 U	1.1 U	0.64 U	0.83 U
CALCIUM, TOTAL	6400	2610	16100	7540
CHROMIUM, TOTAL	5	7.8	4	3.4
COBALT, TOTAL	0.64 U	0.9 U	0.44 U	0.57 U
COPPER, TOTAL	3.4	2.2	2.7	2.8
IRON, TOTAL	2950	5150	1240	1340
LEAD, TOTAL	15.9 J	11 J	53 J	56.3 J
MAGNESIUM, TOTAL	194	205	348	283
MANGANESE, TOTAL	4.8	5.5	5.3	5.3
NICKEL, TOTAL	2.3	2.3	1.4	1.6
POTASSIUM, TOTAL	91.2 U	173	75.7 U	96.4 U
SELENIUM, TOTAL	0.38 U	0.79	0.31 U	0.31 U
SILVER, TOTAL	0.5 U	0.52 U	0.31 U	0.41 U
SODIUM, TOTAL	59.4	48.1	98.7	155
VANADIUM, TOTAL	6.8	9.9	5.5	5.4
ZINC, TOTAL	46.6	9	70.9	67.8

MG/KG - milligram per kilogram
 J - value is estimated
 U - not detected

SECTION 4.0 FIGURES

LOCATION	44-OA-SB02
DATE SAMPLED	03/08/95
SEMIVOLATILES (ug/L)	
2,6-DINITROTOLUENE	380 J

LOCATION	44-OA-SB03
DATE SAMPLED	03/14/95
PESTICIDE/PCBS (ug/L)	
4,4'-DDE	80
4,4'-DDD	7.4 J
4,4'-DDT	45 J

LOCATION	44-OA-SB04
DATE SAMPLED	03/14/95
SEMIVOLATILES (ug/L)	
BENZO(G,H,I)PERYLENE	57 J
PESTICIDE/PCBS (ug/L)	
4,4'-DDE	50 J
4,4'-DDT	19 J

LOCATION	44-OA-SB05
DATE SAMPLED	03/14/95
SEMIVOLATILES (ug/L)	
INDENO(1,2,3-CD)PYRENE	220 J
BENZO(G,H,I)PERYLENE	200 J
PESTICIDE/PCBS (ug/L)	
4,4'-DDE	140
4,4'-DDT	25 J

LOCATION	44-OA-SB06
DATE SAMPLED	03/14/95
SEMIVOLATILES (ug/L)	
BIS(2-CHLOROETHYL)ETHER	550 J
PESTICIDE/PCBS (ug/L)	
4,4'-DDE	10 J
4,4'-DDT	4.6 J

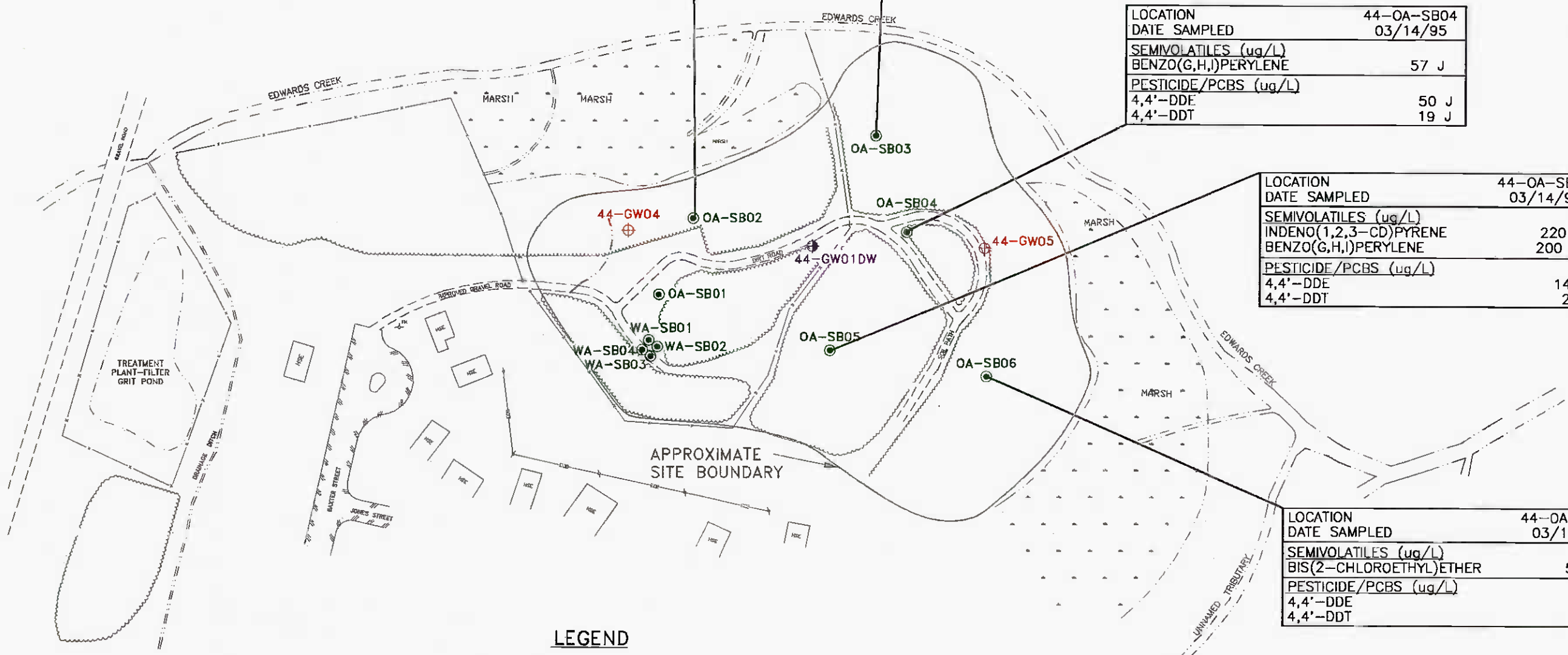

LEGEND

- 44-GW04 (⊕) PILOT TEST BORING FOR SHALLOW MONITORING WELL
- 44-GW01DW (⊕) PILOT TEST BORING FOR DEEP MONITORING WELL
- OA-SB02 (●) SOIL BORING LOCATION
- (X-X) FENCE
- (//) ASPHALT ROAD
- (---) GRAVEL OR DIRT ROAD
- (---) MARSH
- (---) OVERHEAD ELECTRIC LINE & UTILITY POLE
- (---) EDGE OF CREEK, DRAINAGE DITCH, MARSH OR POND
- (---) TREE LINE
- (HSE) BASE HOUSING UNIT



FIGURE 4-1
ORGANIC COMPOUNDS IN SURFACE SOIL
SITE 44, JONES STREET DUMP
REMEDIATION INVESTIGATION, CTO-0303
MARINE CORPS AIR STATION, NEW RIVER
NORTH CAROLINA

NOTE: LOCATIONS SHOWN WITHOUT CONCENTRATIONS INDICATE NONDETECTABLE LEVELS.

01715YR3Y

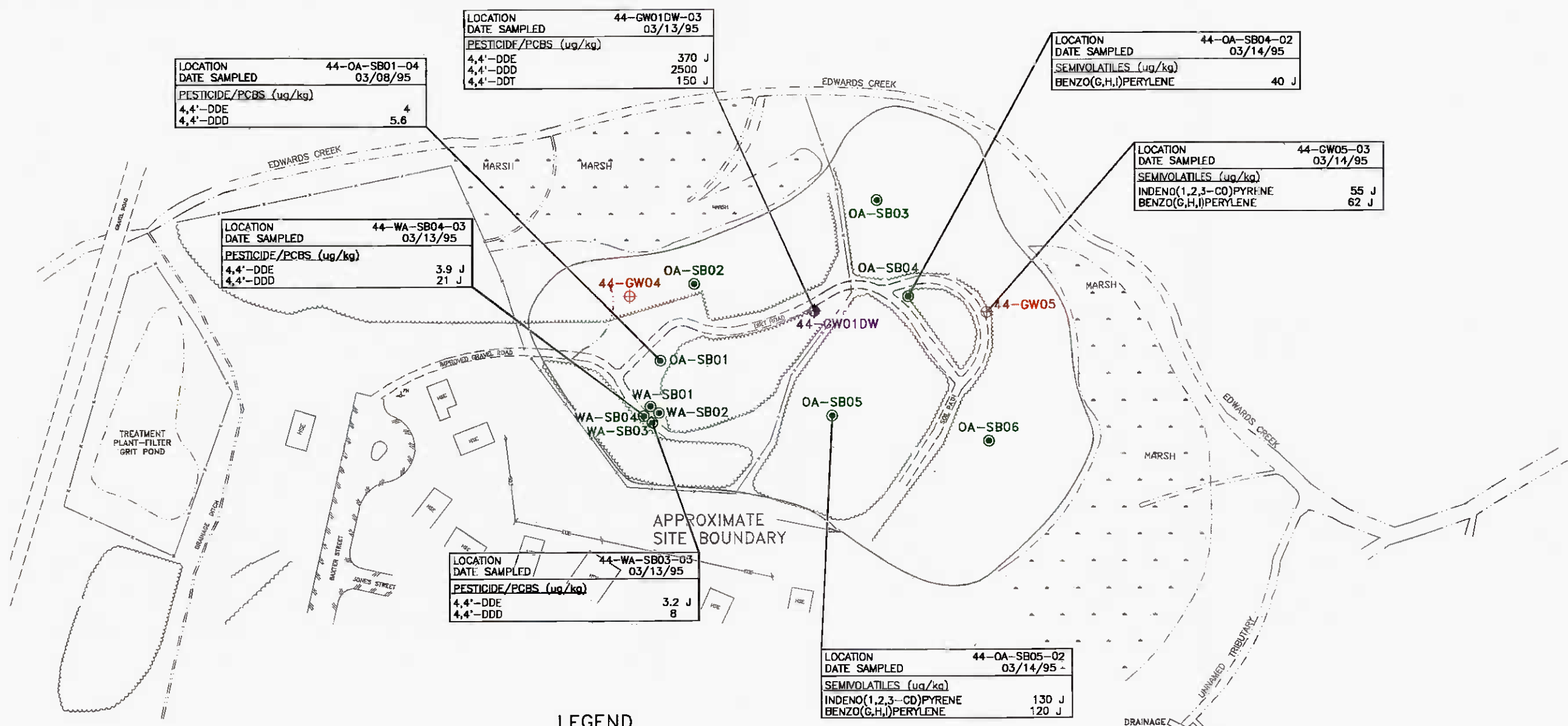

LEGEND

- 44-GW04 ⊕ PILOT TEST BORING FOR SHALLOW MONITORING WELL
- 44-GW01DW ⊙ PILOT TEST BORING FOR DEEP MONITORING WELL
- OA-SB02 ⊙ SOIL BORING LOCATION
- EOE — OVERHEAD ELECTRIC LINE & UTILITY POLE
- x - x - FENCE
- ▨ ASPHALT ROAD
- - - - GRAVEL OR DIRT ROAD
- - - - EDGE OF CREEK, DRAINAGE DITCH, MARSH OR POND
- ~ ~ ~ ~ TREE LINE
- HSE BASE HOUSING UNIT
- ▨ MARSH

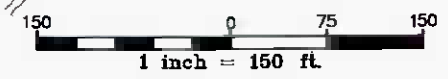

NOTE: LOCATIONS SHOWN WITHOUT CONCENTRATIONS INDICATE NONDETECTABLE LEVELS.

FIGURE 4-2
ORGANIC COMPOUNDS IN SUBSURFACE SOIL
SITE 44, JONES STREET DUMP
REMEDIAL INVESTIGATION, CTO-0303
MARINE CORPS AIR STATION, NEW RIVER
NORTH CAROLINA

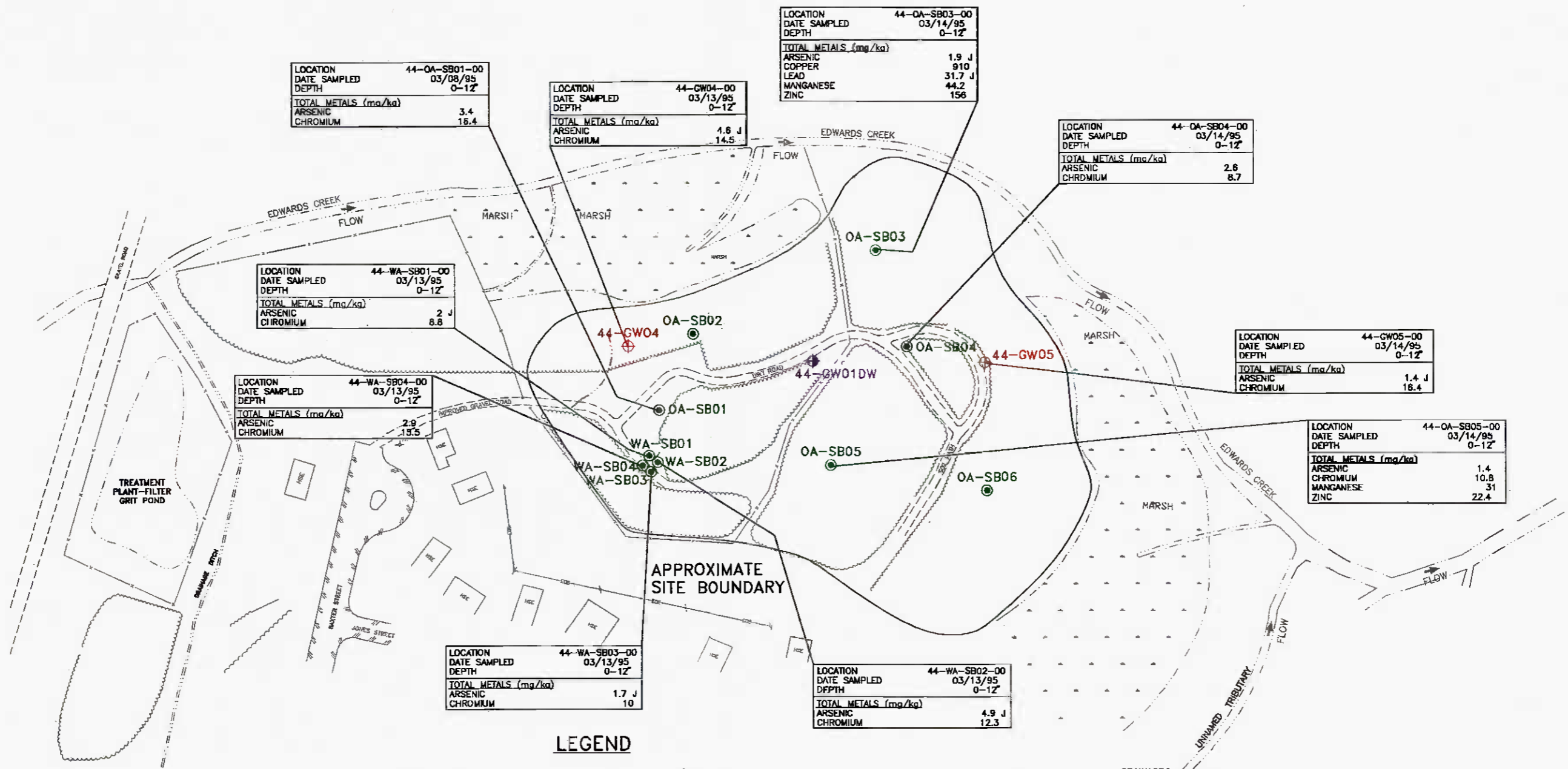

- 44-GW04 ⊕ PILOT TEST BORING FOR SHALLOW MONITORING WELL
- 44-GW01DW ⊕ PILOT TEST BORING FOR DEEP MONITORING WELL
- OA-SB02 ⊙ SOIL TEST BORING LOCATION

LEGEND

- FLOW DIRECTION OF SURFACE WATER FLOW
- Marsh symbol MARSH
- LOE symbol OVERHEAD ELECTRIC LINE & UTILITY POLE
- *-*- FENCE
- Asphalt road symbol ASPHALT ROAD
- Gravel or dirt road symbol GRAVEL OR DIRT ROAD
- Edge of creek, drainage ditch, marsh or pond symbol EDGE OF CREEK, DRAINAGE DITCH, MARSH OR POND
- Tree line symbol TREE LINE
- HSE symbol BASE HOUSING UNIT

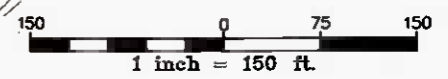
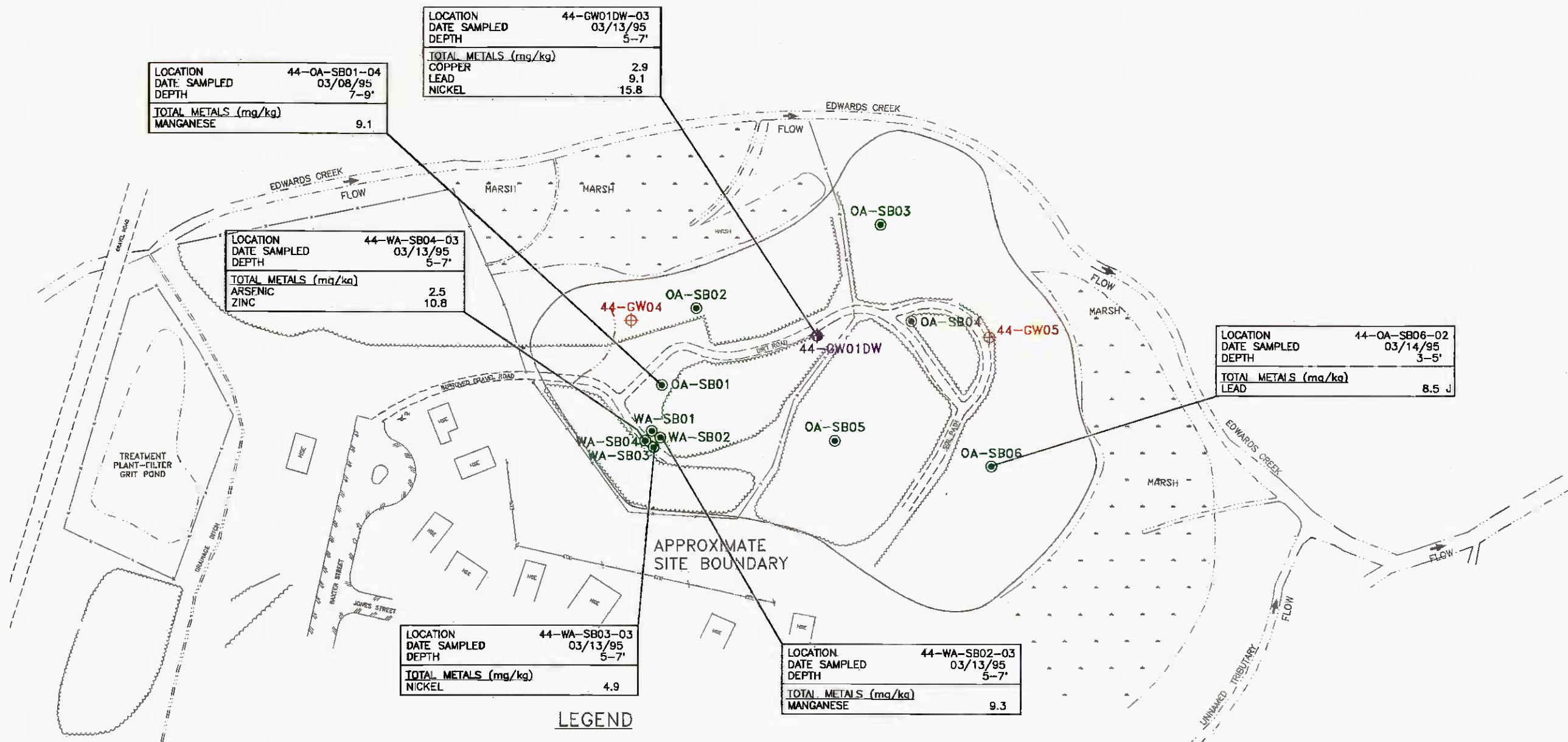

FIGURE 4-3
SELECTED TAL METALS IN SURFACE SOIL
SITE 44, JONES STREET DUMP
REMEDIAL INVESTIGATION, CTO-0303
MARINE CORPS AIR STATION, NEW RIVER,
NORTH CAROLINA



LOCATION	44-OA-SB01-04
DATE SAMPLED	03/08/95
DEPTH	7-9'
TOTAL METALS (mg/kg)	
MANGANESE	9.1

LOCATION	44-GW01DW-03
DATE SAMPLED	03/13/95
DEPTH	5-7'
TOTAL METALS (mg/kg)	
COPPER	2.9
LEAD	9.1
NICKEL	15.8

LOCATION	44-WA-SB04-03
DATE SAMPLED	03/13/95
DEPTH	5-7'
TOTAL METALS (mg/kg)	
ARSENIC	2.5
ZINC	10.8

LOCATION	44-OA-SB06-02
DATE SAMPLED	03/14/95
DEPTH	3-5'
TOTAL METALS (mg/kg)	
LEAD	8.5

LOCATION	44-WA-SB03-03
DATE SAMPLED	03/13/95
DEPTH	5-7'
TOTAL METALS (mg/kg)	
NICKEL	4.9

LOCATION	44-WA-SB02-03
DATE SAMPLED	03/13/95
DEPTH	5-7'
TOTAL METALS (mg/kg)	
MANGANESE	9.3

LEGEND

- 44-GW04 PILOT TEST BORING FOR SHALLOW MONITORING WELL
- 44-GW01DW PILOT TEST BORING FOR DEEP MONITORING WELL
- OA-SB02 SOIL TEST BORING LOCATION

- FLOW DIRECTION OF SURFACE WATER FLOW
- MARSH
- OVERHEAD ELECTRIC LINE & UTILITY POLE
- FENCE
- ASPHALT ROAD
- GRAVEL OR DIRT ROAD
- EDGE OF CREEK, DRAINAGE DITCH, MARSH OR POND
- TREE LINE
- HSE BASE HOUSING UNIT

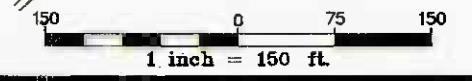
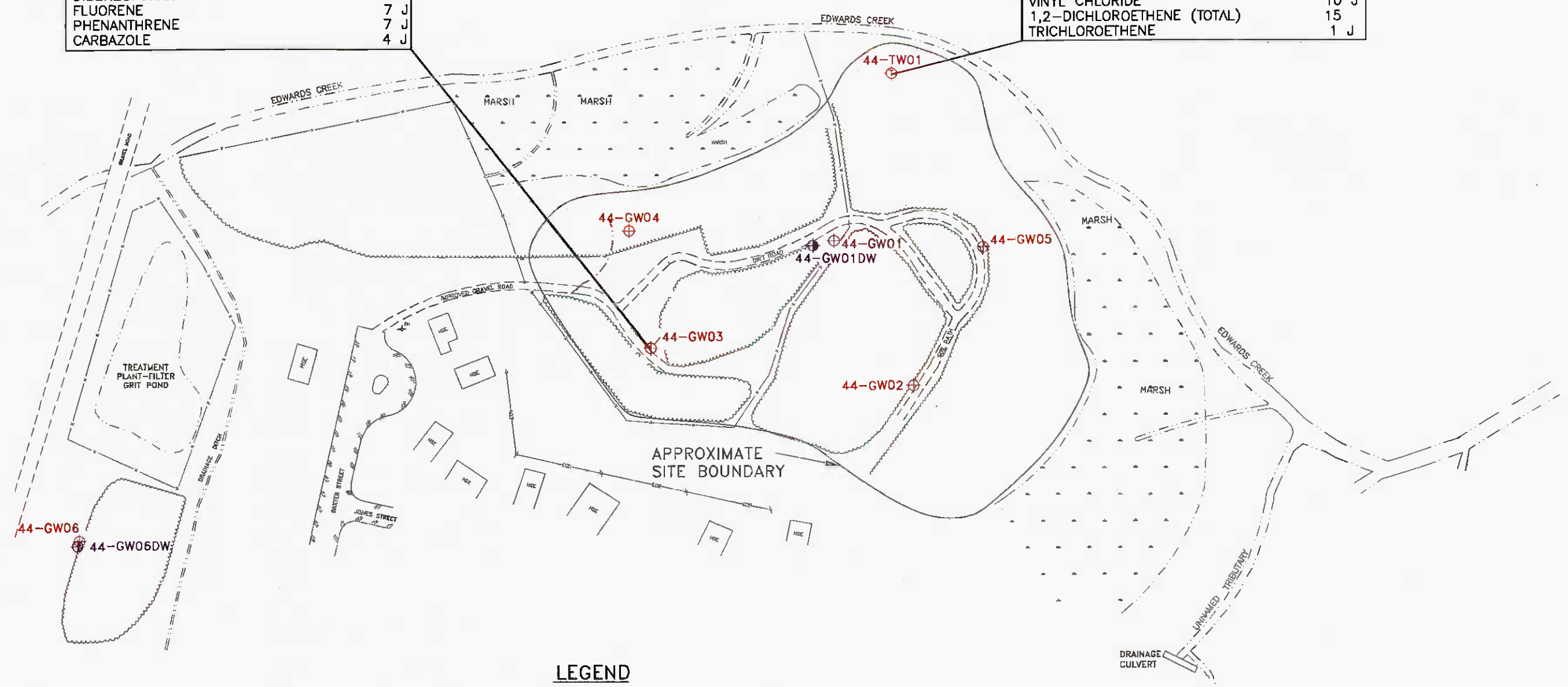

FIGURE 4-4
SELECTED TAL METALS IN
SUBSURFACE SOIL
SITE 44, JONES STREET DUMP
REMEDIAL INVESTIGATION, CTO-0303
MARINE CORPS AIR STATION, NEW RIVER
NORTH CAROLINA

LOCATION	44-GW03-01
DATE SAMPLED	04/10/95
VOLATILES (ug/L)	
TETRACHLOROETHENE	1 J
SEMIVOLATILES (ug/L)	
NAPHTHALENE	71
2-METHYLNAPHTHALENE	4 J
ACENAPHTHENE	13
DIBENZOFURAN	6 J
FLUORENE	7 J
PHENANTHRENE	7 J
CARBAZOLE	4 J

LOCATION	44-TW01-01
DATE SAMPLED	04/10/95
VOLATILES (ug/L)	
VINYL CHLORIDE	10 J
1,2-DICHLOROETHENE (TOTAL)	15
TRICHLOROETHENE	1 J



LEGEND

- 44-GW06 SHALLOW MONITORING WELL
- 44-GW01DW DEEP MONITORING WELL
- 44-TW01 TEMPORARY MONITORING WELL
- MARSH
- OVERHEAD ELECTRIC LINE & UTILITY POLE
- FENCE
- ASPHALT ROAD
- GRAVEL OR DIRT ROAD
- EDGE OF CREEK, DRAINAGE DITCH, MARSH OR POND
- TREE LINE
- BASE HOUSING UNIT

NOTE: LOCATIONS SHOWN WITHOUT CONCENTRATIONS INDICATE NONDETECTABLE LEVELS.

FIGURE 4-5
ORGANIC COMPOUNDS IN GROUNDWATER
SITE 44, JONES STREET DUMP
REMEDIAL INVESTIGATION, CTO-0303
MARINE CORPS AIR STATION, NEW RIVER
NORTH CAROLINA



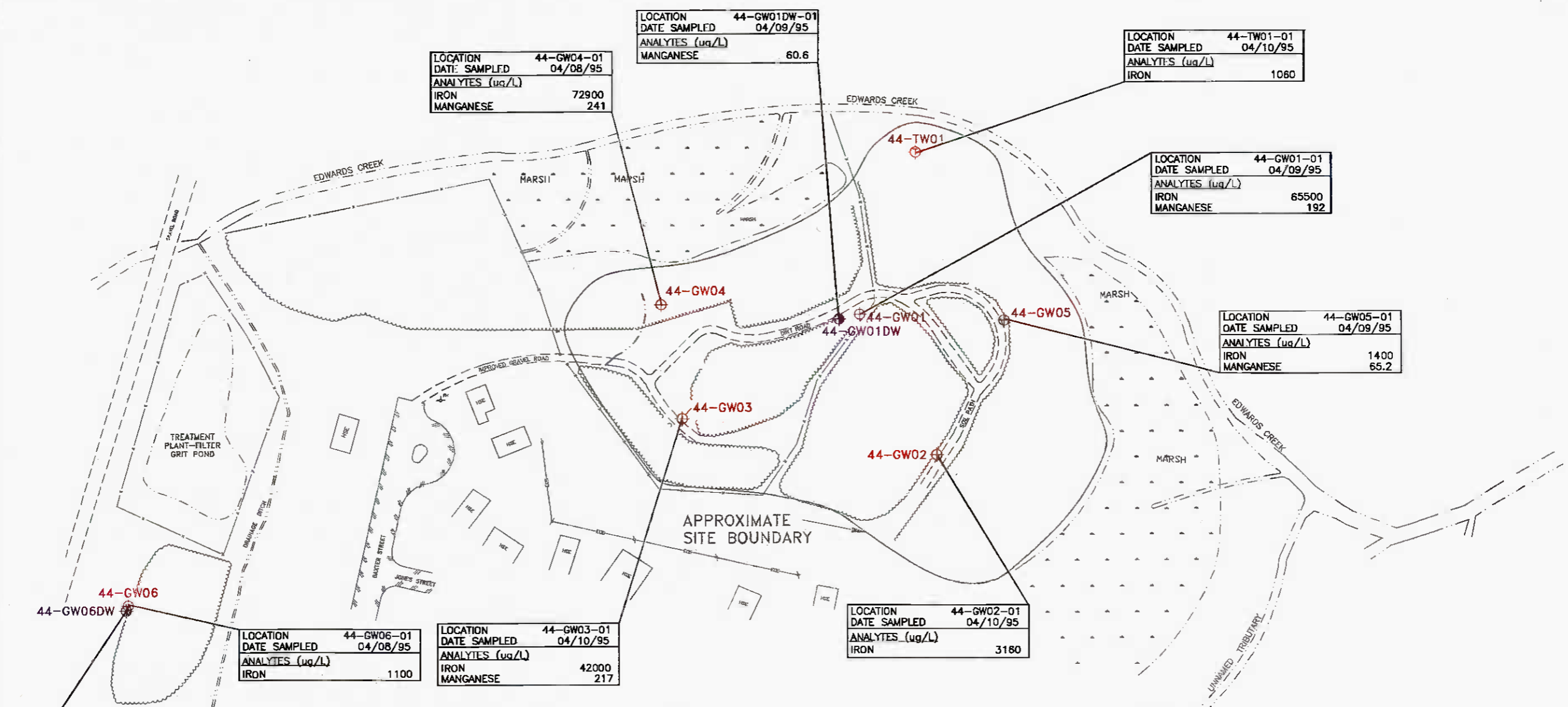

LEGEND

- 44-GW06 SHALLOW MONITORING WELL
- 44-GW06DW DEEP MONITORING WELL
- 44-TW01 TEMPORARY MONITORING WELL
- MARSH
- OVERHEAD ELECTRIC LINE & UTILITY POLE
- FENCE
- ASPHALT ROAD
- GRAVEL OR DIRT ROAD
- EDGE OF CREEK, DRAINAGE DITCH, MARSH OR POND
- TREE LINE
- BASE HOUSING UNIT

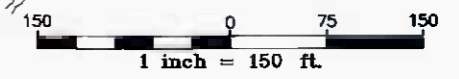
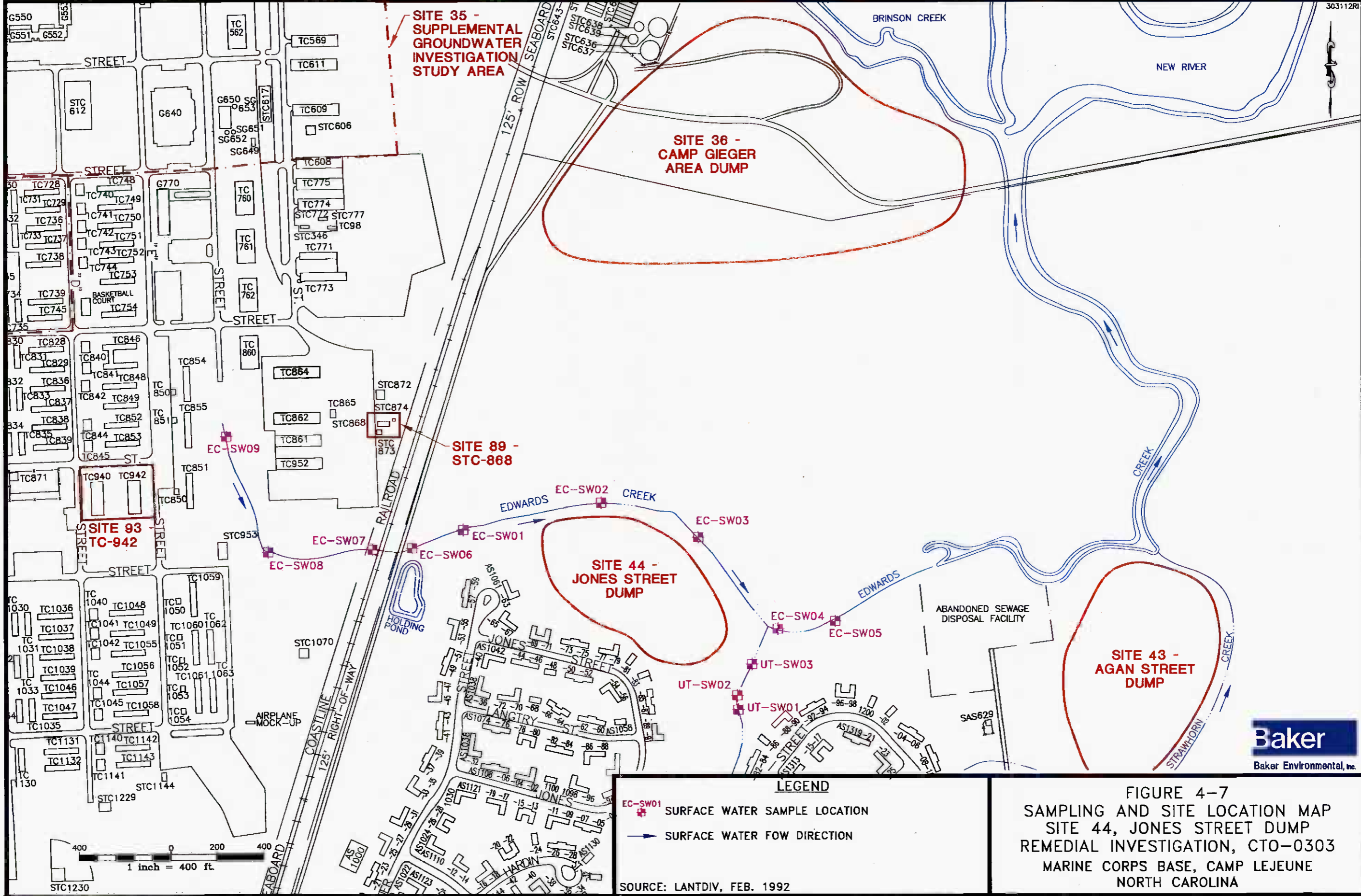

FIGURE 4-6
TAL METALS IN GROUNDWATER
ABOVE SCREENING STANDARDS
SITE 44, JONES STREET DUMP
REMEDIAL INVESTIGATION, CTO-0303
MARINE CORPS AIR STATION, NEW RIVER
NORTH CAROLINA



LEGEND

- EC-SW01 SURFACE WATER SAMPLE LOCATION
- SURFACE WATER FLOW DIRECTION

SOURCE: LANTDIV, FEB. 1992

FIGURE 4-7
SAMPLING AND SITE LOCATION MAP
SITE 44, JONES STREET DUMP
REMEDIAL INVESTIGATION, CTO-0303
MARINE CORPS BASE, CAMP LEJEUNE
NORTH CAROLINA

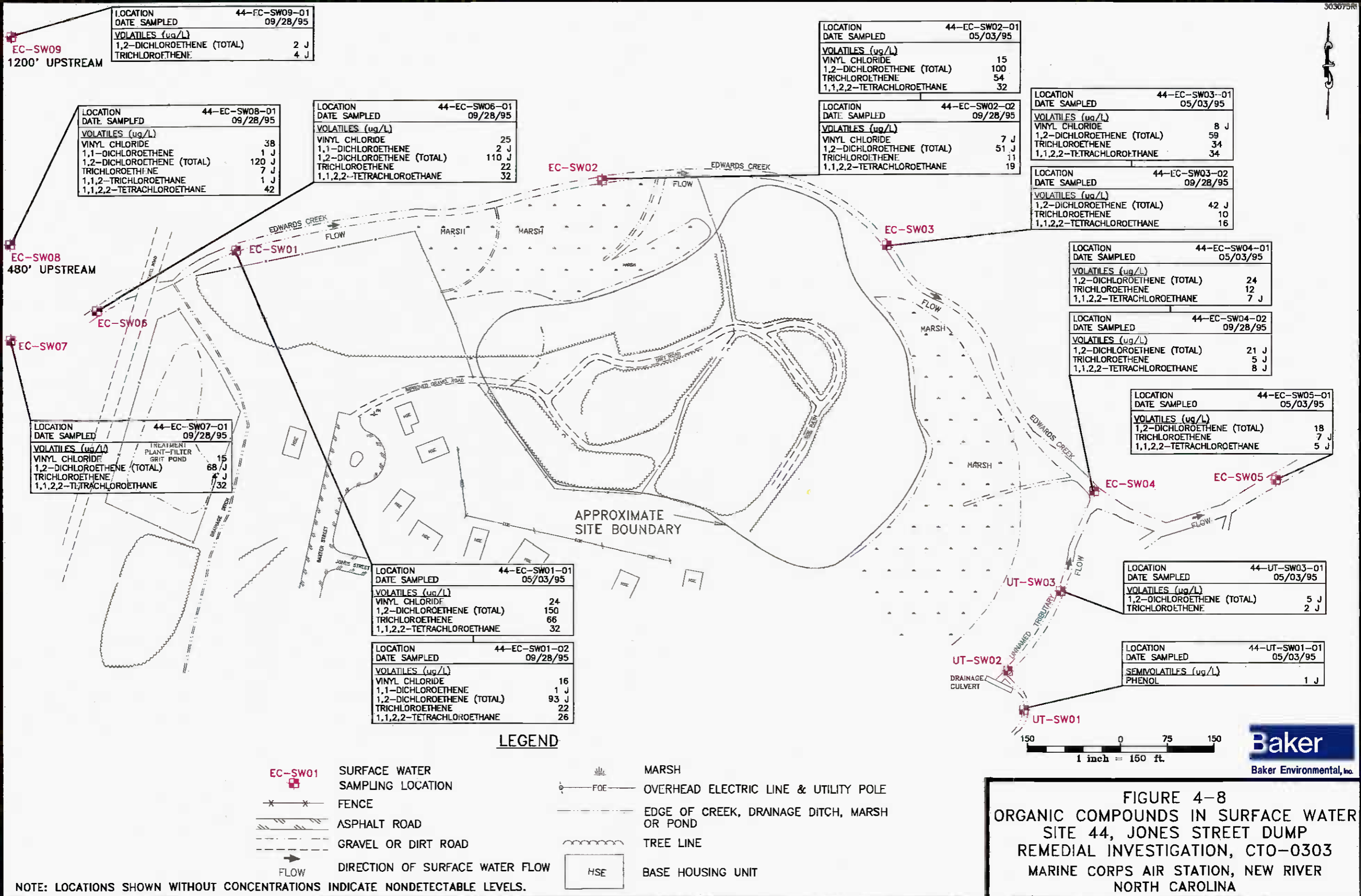

LOCATION	44-EC-SW09-01
DATE SAMPLED	09/28/95
VOLATILES (ug/L)	
1,2-DICHLOROETHENE (TOTAL)	2 J
TRICHLOROETHENE	4 J

LOCATION	44-EC-SW02-01
DATE SAMPLED	05/03/95
VOLATILES (ug/L)	
VINYL CHLORIDE	15
1,2-DICHLOROETHENE (TOTAL)	100
TRICHLOROETHENE	54
1,1,2,2-TETRACHLOROETHANE	32

LOCATION	44-EC-SW03-01
DATE SAMPLED	05/03/95
VOLATILES (ug/L)	
VINYL CHLORIDE	8 J
1,2-DICHLOROETHENE (TOTAL)	59
TRICHLOROETHENE	34
1,1,2,2-TETRACHLOROETHANE	34

LOCATION	44-EC-SW08-01
DATE SAMPLED	09/28/95
VOLATILES (ug/L)	
VINYL CHLORIDE	38
1,1-DICHLOROETHENE	1 J
1,2-DICHLOROETHENE (TOTAL)	120 J
TRICHLOROETHENE	7 J
1,1,2-TRICHLOROETHANE	1 J
1,1,2,2-TETRACHLOROETHANE	42

LOCATION	44-EC-SW06-01
DATE SAMPLED	09/28/95
VOLATILES (ug/L)	
VINYL CHLORIDE	25
1,1-DICHLOROETHENE	2 J
1,2-DICHLOROETHENE (TOTAL)	110 J
TRICHLOROETHENE	22
1,1,2,2-TETRACHLOROETHANE	32

LOCATION	44-EC-SW02-02
DATE SAMPLED	09/28/95
VOLATILES (ug/L)	
VINYL CHLORIDE	7 J
1,2-DICHLOROETHENE (TOTAL)	51 J
TRICHLOROETHENE	11
1,1,2,2-TETRACHLOROETHANE	19

LOCATION	44-EC-SW03-02
DATE SAMPLED	09/28/95
VOLATILES (ug/L)	
1,2-DICHLOROETHENE (TOTAL)	42 J
TRICHLOROETHENE	10
1,1,2,2-TETRACHLOROETHANE	16

LOCATION	44-EC-SW04-01
DATE SAMPLED	05/03/95
VOLATILES (ug/L)	
1,2-DICHLOROETHENE (TOTAL)	24
TRICHLOROETHENE	12
1,1,2,2-TETRACHLOROETHANE	7 J

LOCATION	44-EC-SW04-02
DATE SAMPLED	09/28/95
VOLATILES (ug/L)	
1,2-DICHLOROETHENE (TOTAL)	21 J
TRICHLOROETHENE	5 J
1,1,2,2-TETRACHLOROETHANE	8 J

LOCATION	44-EC-SW05-01
DATE SAMPLED	05/03/95
VOLATILES (ug/L)	
1,2-DICHLOROETHENE (TOTAL)	18
TRICHLOROETHENE	7 J
1,1,2,2-TETRACHLOROETHANE	5 J

LOCATION	44-EC-SW07-01
DATE SAMPLED	09/28/95
VOLATILES (ug/L)	
VINYL CHLORIDE	15
1,2-DICHLOROETHENE (TOTAL)	68 J
TRICHLOROETHENE	4 J
1,1,2,2-TETRACHLOROETHANE	32

LOCATION	44-EC-SW01-01
DATE SAMPLED	05/03/95
VOLATILES (ug/L)	
VINYL CHLORIDE	24
1,2-DICHLOROETHENE (TOTAL)	150
TRICHLOROETHENE	66
1,1,2,2-TETRACHLOROETHANE	32

LOCATION	44-EC-SW01-02
DATE SAMPLED	09/28/95
VOLATILES (ug/L)	
VINYL CHLORIDE	16
1,1-DICHLOROETHENE	1 J
1,2-DICHLOROETHENE (TOTAL)	93 J
TRICHLOROETHENE	22
1,1,2,2-TETRACHLOROETHANE	26

LOCATION	44-UT-SW03-01
DATE SAMPLED	05/03/95
VOLATILES (ug/L)	
1,2-DICHLOROETHENE (TOTAL)	5 J
TRICHLOROETHENE	2 J

LOCATION	44-UT-SW01-01
DATE SAMPLED	05/03/95
SEMI-VOLATILES (ug/L)	
PHENOL	1 J

LEGEND

- EC-SW01 ■ SURFACE WATER SAMPLING LOCATION
- x — x — FENCE
- ▬ ASPHALT ROAD
- - - GRAVEL OR DIRT ROAD
- FLOW DIRECTION OF SURFACE WATER FLOW
- ▬ MARSH
- FGE — OVERHEAD ELECTRIC LINE & UTILITY POLE
- - - EDGE OF CREEK, DRAINAGE DITCH, MARSH OR POND
- ~ ~ ~ TREE LINE
- [HSE] BASE HOUSING UNIT

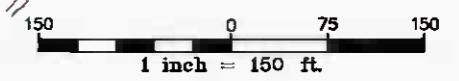

FIGURE 4-8
ORGANIC COMPOUNDS IN SURFACE WATER
SITE 44, JONES STREET DUMP
REMEDIAL INVESTIGATION, CTO-0303
MARINE CORPS AIR STATION, NEW RIVER
NORTH CAROLINA

NOTE: LOCATIONS SHOWN WITHOUT CONCENTRATIONS INDICATE NONDETECTABLE LEVELS.

LOCATION	44-EC-SD01-06
DATE SAMPLED	05/04/95
SEMIVOLATILES (ug/kg)	
CHRYSENE	44 J
BENZO(B)FLUORANTHENE	66 J
PESTICIDE/PCBS (ug/kg)	
4,4'-DDE	30 J
4,4'-DDD	81
4,4'-DDT	9 J
ALPHA-CHLORDANE	2.3 J
GAMMA-CHLORDANE	2.7 J

LOCATION	44-EC-SD02-06
DATE SAMPLED	05/04/95
PESTICIDE/PCBS (ug/kg)	
4,4'-DDE	24 J
4,4'-DDD	66
4,4'-DDT	4.4 J
ALPHA-CHLORDANE	2
GAMMA-CHLORDANE	2.8

LOCATION	44-EC-SD03-06
DATE SAMPLED	05/04/95
PESTICIDE/PCBS (ug/kg)	
4,4'-DDE	9.3 J
4,4'-DDD	23 J

LOCATION	44-EC-SD01-612
DATE SAMPLED	05/04/95
SEMIVOLATILES (ug/kg)	
PENTACHLOROPHENOL	740 J
PESTICIDE/PCBS (ug/kg)	
4,4'-DDE	21 J
4,4'-DDD	34 J
4,4'-DDT	3.1 J
ALPHA-CHLORDANE	2.7 J
GAMMA-CHLORDANE	2.7 J

LOCATION	44-EC-SD02-612
DATE SAMPLED	05/04/95
SEMIVOLATILES (ug/kg)	
FLUORANTHENE	95 J
PYRENE	81 J
CHRYSENE	50 J
BENZO(B)FLUORANTHENE	52 J
PESTICIDE/PCBS (ug/kg)	
4,4'-DDE	58 J
4,4'-DDD	120
4,4'-DDT	3.8 J
ALPHA-CHLORDANE	3.3 J
GAMMA-CHLORDANE	4.2 J

LOCATION	44-EC-SD03-612
DATE SAMPLED	05/04/95
SEMIVOLATILES (ug/kg)	
PENTACHLOROPHENOL	340 J
PESTICIDE/PCBS (ug/kg)	
4,4'-DDE	17 J
4,4'-DDD	35 J
ALPHA-CHLORDANE	2.4 J
GAMMA-CHLORDANE	2.8 J

LOCATION	44-EC-SD05-06
DATE SAMPLED	05/04/95
SEMIVOLATILES (ug/kg)	
FLUORANTHENE	120 J
PYRENE	100 J
CHRYSENE	84 J
BENZO(B)FLUORANTHENE	99 J
BENZO(G,H,I)PERYLENE	49 J
PESTICIDE/PCBS (ug/kg)	
4,4'-DDE	56 J
4,4'-DDD	140
4,4'-DDT	6.5 J
ALPHA-CHLORDANE	6.1 J
GAMMA-CHLORDANE	6.5 J

LOCATION	44-UT-SD02-06
DATE SAMPLED	05/04/95
SEMIVOLATILES (ug/kg)	
PHENANTHRENE	65 J
FLUORANTHENE	170 J
PYRENE	120 J
BUTYLBENZYLPHTHALATE	48 J
BENZO(A)ANTHRACENE	50 J
CHRYSENE	99 J
BENZO(B)FLUORANTHENE	110 J
BENZO(K)FLUORANTHENE	49 J
BENZO(A)PYRENE	56 J
BENZO(G,H,I)PERYLENE	71 J
PESTICIDE/PCBS (ug/kg)	
4,4'-DDE	110 J
4,4'-DDD	85
4,4'-DDT	3.7 J
ALPHA-CHLORDANE	5.1 NJ
GAMMA-CHLORDANE	5.1 J

LOCATION	44-UT-SD03-06
DATE SAMPLED	05/04/95
SEMIVOLATILES (ug/kg)	
PHENANTHRENE	149 J
FLUORANTHENE	210 J
PYRENE	150 J
BENZO(A)ANTHRACENE	58 J
CHRYSENE	130 J
BENZO(B)FLUORANTHENE	160 J
BENZO(K)FLUORANTHENE	160 J
BENZO(A)PYRENE	89 J
PESTICIDE/PCBS (ug/kg)	
4,4'-DDE	9.9 J
4,4'-DDD	14 J
ALPHA-CHLORDANE	5.6 J
GAMMA-CHLORDANE	6.9 J

LOCATION	44-EC-SD04-06
DATE SAMPLED	05/04/95
PESTICIDE/PCBS (ug/kg)	
4,4'-DDE	20 J
4,4'-DDD	33 J
4,4'-DDT	2.6 J
ALPHA-CHLORDANE	2.6 J
GAMMA-CHLORDANE	3 J

LOCATION	44-EC-SD05-612
DATE SAMPLED	05/04/95
SEMIVOLATILES (ug/kg)	
PHENANTHRENE	77 J
FLUORANTHENE	100 J
PYRENE	100 J
CHRYSENE	61 J
PESTICIDE/PCBS (ug/kg)	
4,4'-DDE	150 J
4,4'-DDD	370
4,4'-DDT	130
ALPHA-CHLORDANE	14 J
GAMMA-CHLORDANE	16 J

LOCATION	44-UT-SD03-612
DATE SAMPLED	05/04/95
SEMIVOLATILES (ug/kg)	
PHENANTHRENE	250 J
CARBAZOLE	79 J
FLUORANTHENE	740
PYRENE	490
BENZO(A)ANTHRACENE	170 J
CHRYSENE	460
BENZO(B)FLUORANTHENE	600
BENZO(K)FLUORANTHENE	200 J
BENZO(A)PYRENE	300 J
PESTICIDE/PCBS (ug/kg)	
ALDRIN	2.6 J
HEPTACHLOR EPOXIDE	5.2 J
4,4'-DDE	15 J
4,4'-DDD	21 J
ALPHA-CHLORDANE	7.8 J
GAMMA-CHLORDANE	9.5 J

LOCATION	44-EC-SD04-612
DATE SAMPLED	05/04/95
SEMIVOLATILES (ug/kg)	
PYRENE	42 J
PESTICIDE/PCBS (ug/kg)	
4,4'-DDE	21 J
4,4'-DDD	43 J
4,4'-DDT	2.5 J
ALPHA-CHLORDANE	2.9 J
GAMMA-CHLORDANE	3.3 J

LOCATION	44-UT-SD02-612
DATE SAMPLED	05/04/95
SEMIVOLATILES (ug/kg)	
PHENANTHRENE	69 J
PESTICIDE/PCBS (ug/kg)	
4,4'-DDE	310 J
4,4'-DDD	770
4,4'-DDT	3.1 J
ALPHA-CHLORDANE	2.6 NJ
GAMMA-CHLORDANE	3.6 J

LOCATION	44-UT-SD01-06
DATE SAMPLED	05/04/95
VOLATILES (ug/kg)	
ACETONE	610 J
PESTICIDE/PCBS (ug/kg)	
4,4'-DDE	20 J
4,4'-DDD	5.5 J

LOCATION	44-UT-SD01-612
DATE SAMPLED	05/04/95
PESTICIDE/PCBS (ug/kg)	
4,4'-DDE	25 J
4,4'-DDD	13 J

- LEGEND**
- EC-SD01 SEDIMENT SAMPLING LOCATION
 - FENCE
 - ASPHALT ROAD
 - GRAVEL OR DIRT ROAD

- MARSH
- OVERHEAD ELECTRIC LINE & UTILITY POLE
- EDGE OF CREEK, DRAINAGE DITCH, MARSH OR POND
- TREE LINE
- BASE HOUSING UNIT

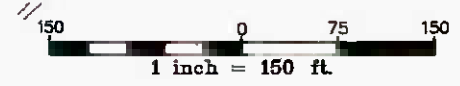
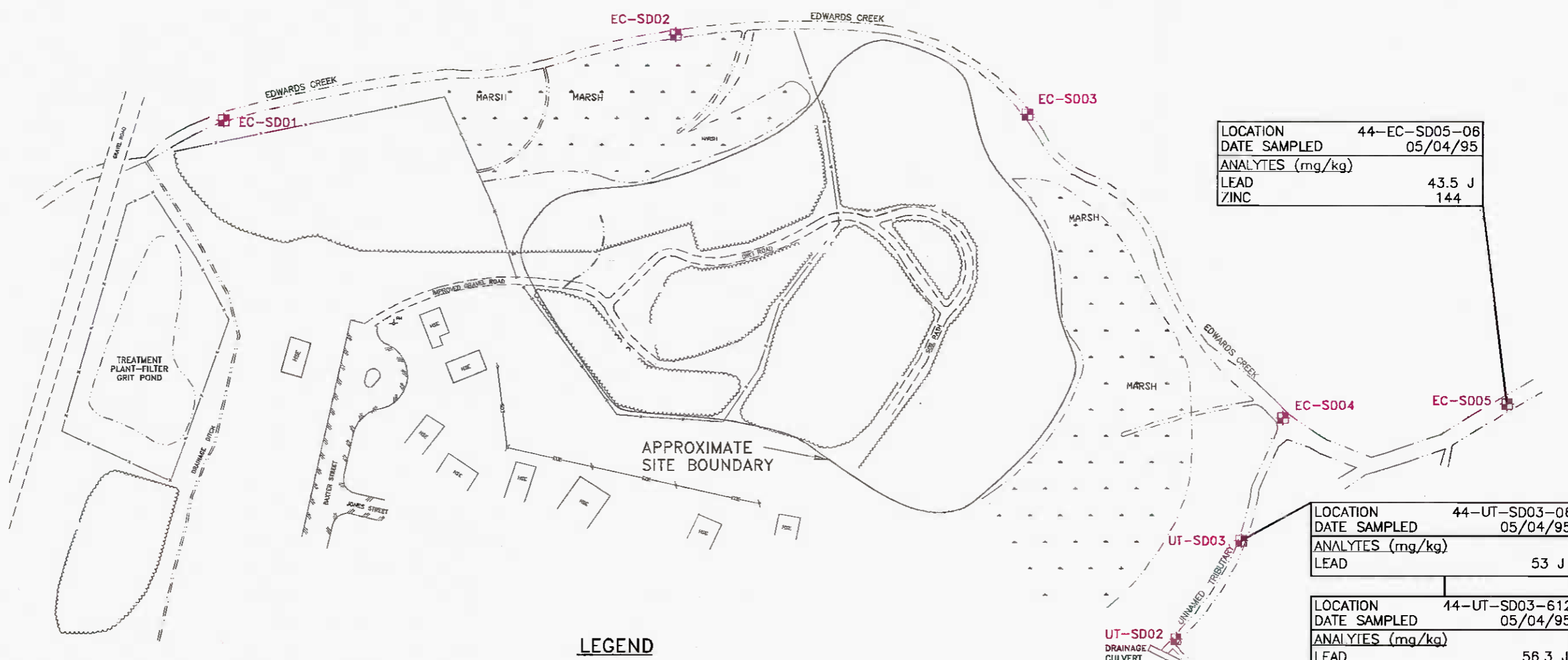

FIGURE 4-9
ORGANIC COMPOUNDS IN SEDIMENT
SITE 44, JONES STREET DUMP
REMEDIAL INVESTIGATION, CTO-0303
MARINE CORPS AIR STATION, NEW RIVER
NORTH CAROLINA



LOCATION	44-EC-SD05-06
DATE SAMPLED	05/04/95
ANALYTES (mg/kg)	
LEAD	43.5 J
ZINC	144

LOCATION	44-UT-SD03-06
DATE SAMPLED	05/04/95
ANALYTES (mg/kg)	
LEAD	53 J

LOCATION	44-UT-SD03-612
DATE SAMPLED	05/04/95
ANALYTES (mg/kg)	
LEAD	56.3 J

LEGEND

- + EC-SD01 SEDIMENT SAMPLING LOCATION
- TREE LINE
- HSE BASE HOUSING UNIT
- MARSH
- OVERHEAD ELECTRIC LINE & UTILITY POLE
- FENCE
- ASPHALT ROAD
- GRAVEL OR DIRT ROAD
- EDGE OF CREEK, DRAINAGE DITCH, MARSH OR POND

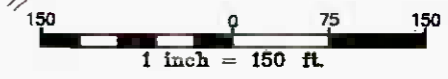

FIGURE 4-10
TAL METALS IN SEDIMENT
ABOVE SCREENING VALUES
SITE 44, JONES STREET DUMP
REMEDIAL INVESTIGATION, CTO-0303
MARINE CORPS AIR STATION, NEW RIVER
NORTH CAROLINA

5.0 CONTAMINANT FATE AND TRANSPORT

The potential for a contaminant to migrate and persist in an environmental medium is critical when evaluating the potential for a chemical to elicit an adverse human health or ecological effect. The environmental mobility of a chemical is influenced by its physical and chemical properties, the physical characteristics of the site, and the site chemistry. This section presents a discussion of the various physical and chemical properties of significant contaminants in Site 44 media discussed in Section 4.0, and their fate and transport in the environment.

5.1 Chemical and Physical Properties Impacting Fate and Transport

Table 5-1 presents the physical and chemical properties associated with the organic compounds detected during this investigation. These properties determine the inherent environmental mobility and fate of a contaminant. The properties of interest include:

- Vapor pressure
- Water solubility
- Octanol/water partition coefficient
- Organic carbon adsorption coefficient (sediment partition)
- Specific gravity
- Henry's Law constant

A discussion of the environmental significance of each of these properties follows.

Vapor pressure provides an indication of the rate at which a chemical may volatilize. It is of primary significance at environmental interfaces such as surface soil/air and surface water/air. Volatilization can be important when evaluating groundwater and subsurface soils, particularly when selecting remedial technologies. Vapor pressure for monocyclic aromatics is generally higher than vapor pressures for PAHs. Contaminants with higher vapor pressures (e.g., VOCs) will enter the atmosphere at a quicker rate than the contaminants with low vapor pressures (e.g., PCBs).

The rate at which a contaminant is leached from soil by infiltrating precipitation is proportional to its water solubility. More soluble contaminants are usually more readily leached than less soluble contaminants. The water solubilities indicate that the volatile organic contaminants, including monocyclic aromatics, are usually several orders-of-magnitude more soluble than PAHs. Consequently, highly soluble compounds such as the chlorinated VOCs will go into solution faster and possibly in greater concentrations than less soluble compounds. The solubility of a specific compound is dependent on the chemistry of the groundwater and aquifer material. Factors such as groundwater pH, Eh (redox potential), temperature, and the presence of other compounds can affect solubility.

The octanol/water partition coefficient (K_{ow}) is the ratio of the chemical concentration in octanol divided by the concentration in water. The octanol/water partition coefficient has been shown to correlate well with bioconcentration factors in aquatic organisms and adsorption to soil or sediment. Specifically, a linear relationship between octanol/water partition coefficients and the uptake of chemicals by fatty tissues of animal and human receptors (the bioconcentration factor - BCF) has been established (Lyman et al., 1982). The coefficient is also useful in characterizing the sorption of compounds by organic soils where experimental values are not available.

The organic carbon adsorption coefficient (K_{oc}) indicates the tendency of a chemical to adhere to the organic carbon in soil particles. The solubility of a chemical in water is inversely proportional to the K_{oc} . Contaminants with high soil/sediment adsorption coefficients generally have low water solubilities. For example, contaminants such as PAHs are relatively immobile in the environment, are preferentially bound to the soil, and have a higher K_{oc} value. These compounds are not subject to aqueous transport to the extent of compounds with higher water solubilities. Mechanical activities (e.g., erosion) and the physical characteristics of surface soils may, however, increase the mobility of these bound soil contaminants.

Specific gravity is the ratio of a given volume of pure chemical at a specified temperature to the weight of the same volume of water at a specified temperature. Its primary use is to determine whether a contaminant will have a tendency to "float" or "sink" (as an immiscible liquid) in water if it exceeds its corresponding water solubility.

Vapor pressure and water solubility are of use in determining volatilization rates from surface water bodies and from groundwater. These two parameters can be used to estimate an equilibrium concentration of a contaminant in the water phase and in the air directly above the water. This relationship is expressed as Henry's Law Constant.

A quantitative assessment of mobility has been developed that uses water solubility (S), vapor pressure (VP), and organic carbon partition coefficient (K_{oc}) (Laskowski, 1983). This value is referred to as the Mobility Index (MI). It is defined as:

$$MI = \log((S*VP)/K_{oc})$$

A scale to evaluate MI as presented by Ford and Gurba (1984) is:

<u>Relative MI</u>	<u>Mobility Description</u>
> 5	extremely mobile
0 to 5	very mobile
-5 to 0	slightly mobile
-10 to -5	immobile
< -10	very immobile

The mobility index for each organic analyte detected at Site 44 is presented on Table 5-1.

5.2 Contaminant Transport Pathways

Based on the evaluation of existing conditions at Site 44, the following potential contaminant transport pathways have been identified.

- Windblown dust
- Leaching of sediment contaminants to surface water
- Migration of contaminants in surface water
- Leaching of soil contaminants to groundwater
- Migration of contaminants in groundwater to surface water

Contaminant concentrations may be affected by one or more mechanisms during transport. Contaminants may be physically transformed by volatilization or precipitation. Contaminants may be chemically transformed through photolysis, hydrolysis, oxidation/reduction. Contaminants may be biologically transformed by biodegradation. Additionally, contaminants may accumulate in one or more media. Because different transformation mechanisms are important for different contaminants, mechanisms are discussed as necessary in Section 5.3.

The paragraphs which follow describe the potential transport pathways listed above with respect to significant compound concentrations. Significant compound concentrations refer to those compounds discussed in Section 4.0 frequently occurring above criteria comparisons. Specific fate and transport concerns are discussed in Section 5.3.

5.2.1 Windblown Dust

The compounds detected in surface soil samples were primarily metals, pesticides and PAHs. These compounds were detected generally in low concentrations at a few, scattered locations across Site 44 (Figure 4-1). The pesticides and PAHs tend to be immobile and adhere to soil particles. Under certain geochemical conditions, metals also can be immobile. Physical movement of these soil particles may be the only mechanism by which these compounds can migrate.

Wind serves as a contaminant transport pathway agent by eroding exposed soil and exposed sediment. This effect is influenced by wind velocity, the grain size/density of the soil/sediment particles, moisture conditions, and the amount of vegetative cover over the soil or sediment.

A majority of the surface area of Site 44 is vegetated. This vegetation reduces the likelihood of fugitive dust generation.

5.2.2 Leaching of Sediment Contaminants to Surface Water

At Site 44, there are two surface water bodies of concern, Edwards Creek and an unnamed tributary to Edwards Creek. The compounds detected in sediment samples were primarily pesticides and PAHs. These compounds were detected in a number of sediment samples collected from both streams (Figures 4-7 and 4-8).

When in contact with surface water, contaminants attached to sediment particles can disassociate from the particle into surface water. This is primarily influenced by the physical and chemical properties of the contaminant (i.e., water solubility, K_{oc}) and the physical and chemical properties of the sediment particle (i.e., grain size, f_{oc}).

5.2.3 Migration of Contaminants in Surface Water

The compounds detected in surface water samples were primarily chlorinated VOCs. These compounds were detected in surface water samples from Edwards Creek (Figures 4-5 and 4-6) and form a distinct trend in the creek, which is discussed in Section 5.3.1. Lead and nickel also appeared in multiple surface water samples.

Releases of VOCs to streams are expected to rapidly volatilize to the atmosphere as a result of high vapor pressures (USHHS, 1991). The portion of a release not evaporating, may dissolve into surface waters as a result of high water solubilities. For larger releases, evaporation may not be a significant

pathway. Additionally, pools of immiscible product may form on the bottom of the surface water body (USHHS, 1991). VOCs tend to have low K_{oc} values and will not readily absorb to sediments with low organic content. Once released to a stream, VOC solute and/or immiscible liquid transport will be dependent on stream flow conditions.

The chlorinated VOCs detected in surface water samples are either primary compounds or daughter products of the primary compounds. According to USDHHS toxicological profile manuals, 1,1,2,2-tetrachloroethane will degrade to trichloroethene. Trichloroethene will degrade primarily to cis-1,2-dichloroethene, and to a lesser extent, trans-1,2-dichloroethene. cis-1,2-Dichloroethene will degrade to chloroethane and, to a lesser extent, vinyl chloride. trans-1,2-Dichloroethene will degrade to vinyl chloride.

A considerable fraction of metals in water is associated with suspended particles. The extent of this association varies greatly with the compound, the properties of the particles, and the type of water. Metals in surface water carried on particles of different types will settle in areas of active sedimentation and will be deposited in the sediments. The metals may be released again through microbial activity and changes in various physical and chemical factors, including pH and Eh.

5.2.4 Leaching of Soil Contaminants to Groundwater

The contaminants present in soil samples at Site 44 are primarily pesticides. These compounds were detected in a limited number of soil samples. Other compounds such as heavy metals and PAHs were also detected, but in a more limited extent than pesticides.

Contaminants that adhere to soil particles or have accumulated in soil pore spaces can leach and migrate vertically to the groundwater as a result of infiltration of precipitation. The rate and extent of leaching is influenced by the depth to the water table, amount of precipitation, rate of infiltration, and the physical and chemical properties of the soil and contaminant.

A qualitative comparison between soil and groundwater analytical data indicates groundwater contamination at Site 44 resultant of contaminants leaching from soil is not evident. This conclusion is supported by facts presented in Section 5.3

5.2.5 Migration of Contaminants in Groundwater to Surface Water

As shown in Section 2.0, shallow groundwater appears to discharge to Edwards Creek. Thus, the potential exists for any contaminants present in groundwater to migrate to surface water; however, as shown in Section 5.3, this pathway is not apparent at this time.

5.3 Fate and Transport Summary

The paragraphs which follow summarize the site-specific fate and transport data for contaminants detected in media collected at Site 44.

5.3.1 Volatile Organic Compounds (VOCs)

VOCs tend to be mobile in environmental media as indicated by their presence in surface water and their corresponding MI values. Their environmental mobility is a function of high water solubilities, high vapor pressures, low K_{ow} and K_{oc} values, and high mobility indices.

In surface media, VOCs will readily volatilize into the atmosphere. VOCs will not partition significantly from the water column to sediment. In natural water and soil systems, VOCs will be slowly biodegraded. Hydrolysis and oxidation are not important fate processes for VOCs in water.

1,1,2,2-Tetrachloroethane, trichloroethene, 1,2-dichloroethene, and vinyl chloride were detected in surface water samples from Edwards Creek. The data and information from this investigation suggests that there is a continuing, upstream source. The source appears to be upstream because the analytical data show a decreasing concentration trend at progressively downstream sampling points, with the highest concentrations located upstream of Site 44. This trend is especially noted with the compound trichloroethene. The trichloroethene concentration in Edwards Creek is highest at Stations 44-EC-SW01 and 44-EC-SW06, located immediately upstream of Site 44. Downstream of these stations, trichloroethene concentrations decrease at stations located adjacent to Site 44. The source appears to be continuing for two reasons. The first reason is the persistence of these compounds throughout the creek, given their volatility. The second reason is that the data are at similar concentrations between the two sampling events.

Two potential upstream sources were noted during a site walk-through in early January, 1996: the DRMO storage facility and Site 89 (former waste oil UST). These two sites are identified on Figure 4-7. A ditch with flowing surface water originating from Site 89 and migrating through the eastern portion of the DRMO facility was observed discharging into Edwards Creek in the vicinity where the VOCs were at their highest concentration. Groundwater at Site 89 is known to have elevated levels of VOCs, (trichloroethene [80 to 1,500 µg/L]; 1,1,2,2-tetrachloroethane [240 to 4,300 µg/L]; tetrachloroethene [35 to 38 µg/L]) similar to those identified in Edwards Creek. This site, as well as the DRMO facility, are scheduled to be investigated by Baker in late 1996.

Similar chlorinated VOCs detected in one groundwater sample collected from temporary well 44-TW01. The occurrence of VOCs in groundwater appears to be limited to this area since VOCs were not detected in the permanent wells located within the suspected disposal area. It appears that the presence of VOCs in this well is related to surface water contaminants rather than the migration of groundwater contaminants from within the suspected disposal area. Well 44-TW01 is approximately 50 feet from Edwards Creek, within the flood plain of the stream (i.e., swampy conditions). This area floods during periods of heavy rain events causing surface water to overflow its banks onto the flood plain. Surface water will infiltrate through the soil into the groundwater. A probable source of the presence of VOCs in well 44-TW01 appears to be infiltration of contaminated surface water. VOCs were not detected in surface soil, subsurface soil, and other groundwater samples at Site 44.

5.3.2 Semivolatile Organic Compounds (SVOCs)

The SVOCs detected were primarily PAH compounds. PAH contamination was encountered primarily in sediment samples, but also in a few surface and subsurface soil samples. Low water solubilities and high K_{ow} and K_{oc} values indicate a strong tendency for PAHs to adsorb to soils, and remain immobile. PAHs have not been detected in groundwater or surface water samples at Site 44, indicating that PAHs are not migrating via these media.

Several other SVOCs were detected in one groundwater sample collected from well 44-GW03. These SVOCs are only slightly more mobile than PAHs. Low water solubilities, and high K_{oc} values indicate a tendency for these SVOCs to adsorb to soils, and be only slightly mobile. These

compounds were not detected in any wells downgradient of 44-GW03, and do not appear to be migrating at this time.

5.3.3 Pesticides

Pesticides have been detected in surface soil, subsurface soil, and sediment samples at a few, scattered locations at Site 44. The pattern of distribution and concentration suggests routine application for insect control rather than product disposal are the source of the pesticides. Table 5-1 shows that pesticides are immobile, mainly due to their affinity for soil surfaces. Pesticides likely have migrated to stream sediment possibly through soil erosion and/or direct deposition from pesticide application at mosquito breeding areas. Pesticides will likely continue to accumulate in sediment as erosion of soils continues. Routine pesticide application is no longer practiced; therefore, the rate of accumulation should diminish with time due to the diminishing availability of pesticides.

5.3.4 Metals

The presence of metals in soil and sediment above criteria levels is limited. Given the limited extent and heavy vegetation, wind transport is not a significant migration pathway. Furthermore, the dissolution of these metals from sediment to surface water, or soils to groundwater has not resulted in concentrations exceeding Federal MCLs, state drinking water standards or other ARARs.

Only iron and manganese occur in groundwater samples exceeding comparison criteria. The paragraphs which follow discuss the occurrence of these metals in groundwater. Table 5-2 presents the relative mobilities of metals as a function of environmental conditions.

Iron and manganese were detected in nearly all groundwater samples from Site 44, and are ubiquitous in all media at MCB, Camp Lejeune. These compounds often exceed comparison criteria and can be contaminants-of-potential-concern for human health and/or ecological risk assessments. Previous studies at Camp Lejeune show that concentrations of iron and manganese are variable and can occur in sediments, surface water, and groundwater at levels exceeding ARARs. It appears that iron and manganese in a particular media may not be associated with waste disposal, but rather be representative of natural conditions.

In a study of trace elements in a coastal plain estuary (Cross, et.al., 1970), iron, manganese, and zinc were found in sediments, surface water, and worm tissue. The study was conducted over a two year period in a river estuary near Morehead City, North Carolina (approximately 40 miles northeast of Camp Lejeune). Multiple samples of surface water, sediment, and worms were collected monthly. Analysis was performed on an extract of the sediments. This study found that iron and manganese levels varied temporally. Levels decreased in samples collected at or near the Atlantic Ocean. The highest concentrations of iron, manganese, and zinc occurred inland, in a station in the Newport River. At this station, the mean levels of iron in sediment extract were reported to range from 380 µg/L to 1,800 µg/L, while manganese ranged from 12 µg/L to 71 µg/L. Median level of iron in surface water was 300 µg/L, while manganese was 22 µg/L. The study found that iron was most abundant, followed by manganese.

According to a study of chemical characteristics of natural waters (Hem, 1992), iron and manganese can occur in water through natural effects. Hem cited a report that observed manganese at 1.0 mg/L small streams due to low dissolved oxygen levels. Hem also reported that manganese can occur in

groundwater above 1.0 mg/L. Manganese can dissolve into groundwater from manganese oxide coatings on soil/sediment particles. Manganese is a significant constituent of many igneous and metamorphic rocks. Small amounts of manganese are commonly present in limestone and dolomite, substituting for calcium. Partially cemented limestone and calcareous sediments are common in the Camp Lejeune area, and were observed at Site 43.

Hem observed iron in surface water at 1.4 mg/L due to organic complexing. Typically, iron in surface water is on the order of 10 µg/L. Iron can occur in groundwater at levels as high as 50 mg/L given certain chemical conditions (a pH between 6 and 8 SU and a bicarbonate activity less than 61 mg/L). A high level of dissolved iron can occur with oxidation of ferrous sulfides. Sulfur is altered to sulfate releasing ferrous iron. Metallic sulfides are common in sedimentary and igneous rocks, or soils/sediments with those source rocks. Hem reported, "The availability of iron for aqueous solutions is strikingly affected by environmental conditions, especially changes in degree or intensity of oxidation or reduction."

Iron and manganese were detected at significant levels only in groundwater at Site 44. The average concentration of iron and manganese in groundwater samples is 20.9 mg/L and 0.1 mg/L, respectively. These concentrations appear to be within natural conditions described by Hem.

5.4 References

Cross, Ford A., Duke, Thomas W., and James N. Willis. 1970. "Biogeochemistry of Trace Elements in a Coastal Plain Estuary: Distribution of Manganese, Iron, and Zinc in Sediments, Water, and Polychaetous Worms." Chesapeake Science. Vol. 11, No. 4, 221-234. December 1970.

Feenstra S., Cherry, J.A., and B.L. Parker. 1995. Dense Chlorinated Solvents in Groundwater: Background History of the Problem. July 1995.

Fetter, C.W. 1986. Applied Hydrogeology. Charles E. Merrill Publishing Co., Columbus, Ohio.

Ford and Gruba. 1984. Methods of Determining Relative Contaminant Mobilities and Migration Pathways Using Physical-Chemical Data.

Hem. 1992. Study of Interpretation of the Chemical Characteristics of Natural Waters. USGS Water-Supply Paper 22254.

Howard, Philip H. 1989. Handbook of Environmental Fate and Exposure Data for Organic Chemicals - Pesticides. Lewis Publishers. Chelsea, Michigan.

Howard, Philip H. 1990. Handbook of Environmental Fate and Exposure Data for Organic Chemicals - Large Production and Priority Pollutants. Lewis Publishers. Chelsea, Michigan.

Howard, Philip H. 1991. Handbook of Environmental Fate and Exposure Data for Organic Chemicals - Solvents. Lewis Publishers. Chelsea, Michigan.

Laskowski, D.A., Goring, C.A., McCall, P.J., and R.L. Swann. 1983. "Terrestrial Environment in Environmental Risk Analysis for Chemicals." Environmental Risk Analysis for Chemicals. R.A. Conways, ed., Van Nostrand Reinhold Company, New York, New York.

Lyman, W.J., Rechl, W.F. and D.H. Rosenblatt. 1982. Handbook of Chemical Property Estimation Methods. McGraw-Hill, Inc., New York,.

Superfund Chemical Data Matrix (SCDM). 1991. United States Environmental Protection Agency Hazardous Site Evaluation Division. December 1991.

Swartbaugh, et al. "Remediating Sites Contaminated with Heavy Metals." Hazardous Materials Control. November/December 1992.

United States Department of Human and Health Services (USHHS). 1991. Toxicological Profile for Trichloroethene. U.S. Department of Human and Health Services.

United States Department of Human and Health Services (USHHS). 1990. Toxicological Profile for 1,1-Dichloroethene. U.S. Department of Human and Health Services.

SECTION 5.0 TABLES

TABLE 5-1

**ORGANIC PHYSICAL AND CHEMICAL PROPERTIES
SITE 44, JONES STREET DUMP
REMEDIAL INVESTIGATION, CTO-0303
MCB, CAMP LEJEUNE, NORTH CAROLINA**

Contaminants of Potential Concern	Vapor Pressure (mm Hg)	Water Solubility (mg/L)	Log K _{ow}	Log K _{oc}	Specific Gravity (g/cm ³)	Henry's Law Constant (atm-m ³ /mole)	Mobility Index	Comments
Volatiles								
Acetone	270	1.00E+06	-0.24	0.34	NA	2.06E-05	8.1	Extremely Mobile
2-Butanone	77.5	2.68E+05	0.26	0.65	NA	2.74E-05	6.67	Very Mobile
1,1-Dichloroethene	600	2250	1.84	1.81	NA	3.40E-02	4.3	Very Mobile
1,2-Dichloroethene	200	600	1.48	2.26	1.22	1.90E-01	3.00	Very Mobile
1,1,2-Trichloroethane	30	4500	2.47	1.75	1.44	1.17E-03	3.4	Very Mobile
1,1,2,2-Tetrachloroethane	5	2900	2.39	118	1.6	3.81E-04	2.2	Very Mobile
Trichloroethene	57.9	1100	2.38	126	1.46	9.1E-03	2.8	Very Mobile
Vinyl Chloride	2660	2670	1.38	1.8	0.91	8.19E-02	5	Very Mobile
Semivolatiles								
Benzo(a)anthracene	5.0E-09	0.014	5.61	5.34	NA	1.00E-06	-15.50	Very Immobile
Benzo(a)pyrene	5.0E-09	0.0038	6.04	5.72	NA	4.90E-07	-16.40	Very Immobile
Benzo(b)fluoranthene	1E-06 to 1E-07	0.009	6.57	6.26	NA	1.22E-06	-14.00	Very Immobile
Benzo(g,h,i)perylene	0	0	6.51	NA	NA	1.21E-07	NA	NA
Benzo(k)fluoranthene	9.6E-11	0.0016	6.84	6.22	NA	3.87E-05	-19.00	Very Immobile
Bis(2-ethylhexyl)phthalate	6.45E-06	0.3	5.11	4-5	NA	1.1E-05	NA	NA
Carbazole	NA	NA	NA	NA	NA	NA	NA	NA
Chrysene	1E-06 to 1E-11	0.006	5.61	5.44	1.274	1.10E-06	-13.70	Very Immobile
Fluoranthene	1E-06 to 1E-04	0.265	5.33	4.84	NA	6.50E-06	-9.40	Immobile
Pentachlorophenol	1.10E-04	14	5	4.7	NA	2.75E-06	-7.5	Immobile
Phenanthrene	6.8E-04	1.29	4.46	4.1	1.025	2.25E-04	NA	NA
Phenol	3.41E-01	9.30E+04	1.46	1.2	NA	4.54E-07	3.3	Very Mobile
Pyrene	6.85	0.14	5.32	4.91	NA	5.10E-06	-11.90	Very Immobile

TABLE 5-1 (Continued)

ORGANIC PHYSICAL AND CHEMICAL PROPERTIES
 SITE 44, JONES STREET DUMP
 REMEDIAL INVESTIGATION, CTO-0303
 MCB, CAMP LEJEUNE, NORTH CAROLINA

Contaminants of Potential Concern	Vapor Pressure (mm Hg)	Water Solubility (mg/L)	Log K _{ow}	Log K _{oc}	Specific Gravity (g/cm ³)	Henry's Law Constant (atm-m ³ /mole)	Mobility Index	Comments
Pesticides								
Aldrin	6.00E-06	1.80E-01	5.30	5	NA	1.60E-05	-11.00	Very Immobile
4,4'-DDD	1.0E-06	0.09	5.99	4.47	NA	2.20E-08	-12.00	Very Immobile
4,4'-DDE	0.0000065	0.04	4.28	3.66	NA	6.80E-05	-10.00	Immobile
4,4'-DDT	1.9E-07	0.0034	6.19	4.89	NA	1.58E-05	-14.00	Very Immobile
Heptachlor epoxide	1.95E-05	0.200	5.40	NA	NA	3.20E-05	NA	NA
alpha-Chlordane	4.6E-04	1.0E-01	5.54	NA	NA	4.85E-05	NA	NA
gamma-Chlordane	4.6E-04	1.0E-01	5.54	NA	NA	4.85E-05	NA	NA

Notes:

NA = Not Available

References:

- Howard, 1989-1991
- Montgomery, 1990
- Sax and Lewis, 1987
- SCDM, 1991
- USEPA, 1986
- USEPA, 1986a
- Verscheuren, 1983

TABLE 5-2

RELATIVE MOBILITIES OF METALS AS A FUNCTION OF ENVIRONMENTAL CONDITIONS (Eh, pH)
 SITE 44, JONES STREET DUMP
 REMEDIAL INVESTIGATION, CTO-0303
 MCB, CAMP LEJEUNE, NORTH CAROLINA

Relative Mobility	Environmental Conditions			
	Oxidizing	Acidic	Neutral/ Alkaline	Reducing
Very high			Se	
High	Se, Zn	Se, Zn, Cu, Ni, Hg, Ag		
Medium	Cu, Ni, Hg, Ag, As, Cd	As, Cd	As, Cd	
Low	Pb, Ba, Se	Pb, Ba, Be	Pb, Ba, Be	
Very Low	Fe, Cr	Cr	Cr, Zn, Cu, Ni, Hg, Ag	Cr, Se, Zn, Cu, Ni, Hg, Pb, Ba, Be, Ag

Notes:

Se = Selenium	Cd = Cadmium
Zn = Zinc	Ba = Barium
Cu = Copper	Pb = Lead
Ni = Nickel	Fe = Iron
Hg = Mercury	Cr = Chromium
Ag = Silver	Be = Beryllium
As = Arsenic	Zn = Zinc

Source: Swartzbaugh, et al. "Remediating Sites Contaminated with Heavy Metals."
 Hazardous Materials Control, November/December 1992.

6.0 BASELINE HUMAN HEALTH RISK ASSESSMENT

The following subsections present the baseline human health risk assessment (BRA) conducted for Site 44, Jones Street Dump. This assessment was performed in accordance with the USEPA document Risk Assessment Guidance for Superfund, Human Health Evaluation Manual: Part A (USEPA, 1989). The purpose of the BRA is to assess whether the contaminants of potential concern (COPCs) at the site pose a current or future risk to human health in the absence of remedial action. COPCs are site-related contaminants used to quantitatively estimate human exposures and associated potential health effects. Because the purpose of the risk assessment is to estimate the degree of risk to human health and to be protective of human health, the approach of the USEPA guidance is designed to be conservative. This protectiveness is achieved by the use of assumptions and models that result in upper bound estimates of risk, i.e., the true or actual risk is expected to fall between the estimated value and zero. As a result, the actual site risks are unlikely to exceed the estimated upper bound values and are probably lower than these values. The following paragraphs present a brief overview of the risk assessment process and how the assessment affects further activity at the sites.

For the BRA, both current and future land use exposure scenarios were assumed for the site. The current scenario reflects potential human exposure pathways to the COPCs that presently exist at the site (i.e., exposure pathways currently available). Likewise, the future use scenario represents exposure pathways that are conceivable in the future (e.g., residential development). The future use is typically determined by zoning and the environmental setting of the site. The development of current and future use exposure scenarios is consistent with the methodology for baseline risk assessment, as specified by USEPA.

The National Contingency Plan (NCP) stipulates a range of acceptable cancer risk levels of 1×10^{-4} to 1×10^{-6} for total risk at a hazardous waste site (USEPA, 1990). These cancer risk levels represent the probability of an individual developing cancer over his or her lifetime if exposed to the COPCs at the site. For example, a risk level of 1×10^{-6} is the probability that one person in 1,000,000 exposed persons will develop cancer in a lifetime. The total noncarcinogenic acceptable risk level is a hazard index of less than or equal to 1.0. This noncancer risk level depicts a level at or below which adverse systemic effects are not expected in the exposed population.

A remedial action is recommended when either the total cancer or noncancer risks are above the criteria established by the NCP. Some form of remedial action also is necessary when either the current or future exposure point concentrations at the site are above the applicable or suitable analogous standards (e.g., maximum contaminant levels [MCLs] for drinking water) for those COPCs for which standards exist. When a remedial action is necessary, applicable or relevant and appropriate requirements (ARARs) and/or risk-based cleanup levels are used in determining acceptable concentrations in the environmental media. No remedial response is required when the cancer and noncancer criteria and the ARARs are not exceeded.

6.1 Introduction

The BRA investigates the potential for COPCs to affect human health and/or the environment, both now and in the future, under a "no further remedial action scenario." The BRA process evaluates the data generated during the sampling and analytical phase of the RI, identifying areas of interest and COPCs with respect to geographical, demographic, and physical and biological characteristics of the study area. These, combined with the current understanding of physical and chemical

properties of the site-associated constituents (with respect to environmental fate and transport processes), are then used to estimate the concentrations of contaminants at the end points of logical exposure pathways. Finally, contaminant intakes by hypothetical receptors are determined and combined with the toxicological properties of the contaminants to estimate (inferentially) the potential public health impacts posed by constituents detected at the site.

The BRA for the site was conducted in accordance with current USEPA Risk Assessment Guidance (USEPA, 1989 and USEPA, 1991), and USEPA Region IV Supplemental Risk Guidance (USEPA, 1992d).

The components of the BRA include the following:

- Hazard Identification: determination as to whether a substance has the potential to elicit an adverse effect (toxicity) upon exposure to humans
- Exposure Assessment: identification of the human population(s) likely to be exposed and the development of specific exposure pathways for the population
- Toxicity Assessment: quantification of the relationship between the human exposure and the probability of occurrence (risk) of a toxic response
- Risk Characterization: development of a quantitative estimation of the potential risk from a combination of information collected during the exposure and toxicity assessment
- Uncertainty Analysis: identification and qualitative discussion of any major sources of uncertainty pertaining to the finding of the BRA
- Conclusions: summarization and conclusion of the results of the BRA relating to the total site risk are drawn

Each of these components of the BRA is discussed and addressed for the site. Introductory text is presented first, followed by a site-specific discussion. Referenced tables and figures are presented after the text portion of this section.

6.2 Hazard Identification

Data generated during the remedial investigation and previous studies at the site were used to draw conclusions and to identify data gaps in the BRA. The data were evaluated to assess which data were of sufficient quality to include in the risk assessment. The objective when selecting data to include in the risk assessment was to provide accurate and precise data to characterize contamination and evaluate exposure pathways.

6.2.1 Data Evaluation and Reduction

The initial hazard identification step entailed the validation and evaluation of the site data to determine its usability in the risk assessment. This process resulted in the identification of COPCs for the site. During this validation and evaluation, data that would result in inaccurate conclusions (e.g., data that were rejected or attributed to blank contamination, as qualified by the validator) were

reduced within the data set. Data reduction entailed the removal of unreliable data from the original data set based on the guidelines established by USEPA. A summary of the data quality was presented in Section 5.0.

6.2.2 Identification of Data Suitable for Use in a Quantitative Risk Assessment

To provide for accurate conclusions to be drawn from sampling results, analytical data were reviewed and evaluated. During this review and evaluation, data that would lead to inaccurate conclusions were reduced within each data set. This section presents the criteria that were used to review, reduce, and summarize the analytical data. These criteria are consistent with USEPA guidance for data reduction.

Five environmental media were investigated at the site during this RI: surface soils, subsurface soils, groundwater, surface water, and sediment. For Site 44, these media were assessed for potential risk to human receptors. Specifically, surface water and sediment samples were collected from the two surface water bodies of concern at the site: Edwards Creek and an unnamed tributary to Edwards Creek. For a more detailed discussion on sampling procedure, refer to Section 3.0.

In addition, the shallow and deep groundwater at Site 44 were evaluated as a single exposure source. Although shallow groundwater is not used potably at the sites, it has been shown that there is a potential interconnection between the shallow and deep aquifers (see Section 3.0). Consequently, exposure to both sources of groundwater were evaluated. Current receptors (military personnel, military dependents, and civilian base personnel) are exposed via ingestion, dermal contact, and inhalation to groundwater drawn from the deep zone. Hence, assessing current risks to contaminants detected in the shallow aquifer for current receptors is unnecessary and, if estimated, may present an unlikely risk. Therefore, groundwater exposure to current receptors was not estimated for this investigation.

Information relating to the nature and extent of contamination at the site is provided in Section 4.0 of this report. The discussion provided in Section 4.0 also was utilized in the selection of COPCs at the site. The reduced data sets for all media of concern at the site are provided in Appendices H and I of this report.

6.2.3 Criteria Used in Selection of COPCs

This section presents the criteria used in the selection of COPCs for the evaluation of potential human health risk. As exemplified by the data summary tables in Appendices H and I, the number of constituents positively detected at least once during the field investigation is large. Quantifying risk for all positively identified parameters may distract from the dominant risks presented by the site. Therefore, the data set (resulting data set after applying the criteria listed in the previous section) was reduced to a list of COPCs. As stated previously, COPCs are site-related contaminants used to quantitatively estimate human exposures and associated potential health effects.

The selection of the COPCs was based on a combination of detected concentrations; toxicity; frequency of detection; comparison to background values, including site-specific, base-specific and published ranges; and comparison of physiochemical properties, including mobility, persistence, and toxicity. In addition, historical information pertaining to past site activities was considered. USEPA guidance states that a contaminant may not be retained for quantitative evaluation in the BRA if: (1) it is detected infrequently in an environmental medium (e.g., equal to or less than 5 percent

for at least 20 samples per data set), (2) it is absent or detected at low concentrations in other media, or (3) site history does not provide evidence the contaminant to be present (USEPA, 1989). To qualitatively assess the COPCs, comparisons of results to Federal and state criteria and Region III Contaminant of Concern (COC) Screening Values (USEPA, 1995) were used. A brief description of the selection criteria used in choosing final COPCs is presented below. A contaminant did not need to meet the criteria of all of these three categories in order to be retained as a COPC.

6.2.3.1 Site Setting and History

Setting

The Jones Street Dump (Site 44) encompasses approximately 5 acres and is situated within the operations area of Marine Corps Air Station (MCAS) New River, two miles east of the main entrance. There is vehicle access to the site via Baxter Street, behind base housing units along Jones Street. The site lies to the east of the fenced compound. The site is bordered to the north and west by Edwards Creek, to the south by base housing units along Jones Street, and to the east by woods and an unnamed tributary to Edwards Creek. Edwards Creek flows east from the study area toward Site 43, which is located about 2,000 feet to the east of Site 44.

A majority of the site is comprised of a gently dipping open field that slopes toward Edwards Creek. The field is covered with high grass, weeds, and small pine trees that are less than two inches in diameter. Surrounding the open field is a mature wooded area with dense understory. Presently, access to Site 44 is unrestricted.

History

The Jones Street Dump was officially in operation during the 1950s. Reportedly, Site 44 served as a dump for municipal waste and various debris. It has also been reported that some potentially hazardous materials may have been disposed at this site. The particular types and quantities of these wastes, however, are not known. WAR conducted an IAS at Site 44 in 1983. This study produced evidence that construction debris and small quantities of potentially hazardous waste were disposed of at the dump.

Baker conducted an SI at Site 44 in 1991. Soil samples obtained at Site 44 contained low levels of PAHs and specific pesticides (i.e., 4,4'-DDE and 4,4'-DDD). Inorganics were detected in soil samples at concentrations exceeding twice the base-specific background levels. Groundwater samples contained inorganics at concentrations exceeding state and Federal criteria. Low concentrations of PAHs were detected in one well, and toluene and ethylbenzene were detected in another well at concentrations below state and Federal standards. Surface water samples contained inorganics at low levels. Sediment samples contained trace levels of pesticides and semivolatiles, as well as slightly elevated concentrations of copper, lead, and zinc.

6.2.3.2 Frequency of Detection

In general, constituents that were detected infrequently (e.g., equal to or less than 5 percent, when at least 20 samples of a medium are available) may be anomalies due to sampling or analytical errors or may be present simply in the environment due to past or current site activities. It should be noted, however, that detected constituents were individually evaluated prior to exclusion from the BRA.

Physiochemical properties (i.e., fate and transport) and toxicological properties for each detected constituent were evaluated (see following sections).

6.2.3.3 Comparison to Background

Sample concentrations were compared to site-specific (i.e., twice the base-specific average concentration) background levels. Background information was available for all media of concern at the site, except groundwater. The results of these comparisons are presented in Tables 6-1 through 6-7.

6.2.3.4 Physiochemical Properties

Mobility

The physical and chemical properties of a contaminant are responsible for its transport in the environment. These properties, in conjunction with site conditions, determine whether a contaminant will tend to volatilize into the air from surface soils or surface waters or be transported via advection or diffusion through soils, groundwaters, and surface waters. Physical and chemical properties also describe a contaminant's tendency to adsorb onto soil/sediment particles. Environmental mobility can correspond to either an increased or decreased potential to affect human health and/or the environment.

Persistence

The persistence of a contaminant in the environment depends on factors such as the microbial content of soil and water, organic carbon content, the concentration of the contaminant, climate, and the ability of the microbes to degrade the contaminant under site conditions. In addition, chemical degradation (i.e., hydrolysis), photochemical degradation, and certain fate processes such as sorption may contribute to the elimination or retention of a particular compound in a given medium.

6.2.3.5 Toxicity

The potential toxicity of a contaminant is an important consideration when selecting COPCs for further evaluation in the human health assessment. For example the weight-of-evidence (WOE) classification should be considered in conjunction with concentrations detected at the site. Some effects considered in the selection of COPCs include carcinogenicity, mutagenicity, teratogenicity, systemic effects, and reproductive toxicity. Bioaccumulation and bioconcentration properties may affect the severity of the toxic response in an organism and/or subsequent receptors and are evaluated if relevant data exist.

Despite their inherent toxicity, certain inorganic contaminants are essential nutrients. Essential nutrients need not be considered for further consideration in the quantitative risk assessment if they are present in relatively low concentrations (i.e., below twice the average base-specific background levels or slightly elevated above naturally occurring levels) or if the contaminant is toxic at doses much higher than those which could be assimilated through exposures at the site. Due to the difficulty of determining nutrient levels that were within acceptable dietary levels, only essential nutrients present at low concentrations (i.e., only slightly elevated above background) were eliminated from the BRA. Essential nutrients, however, were included in the ecological risk evaluation.

6.2.3.6 Contaminant Concentrations in Blanks

Sample concentrations were compared quantitatively to investigation-related blank concentrations. Sample concentrations of parameters that are typical laboratory or field contaminants (i.e., acetone, 2-butanone, methylene chloride, toluene, and phthalate esters) that exceeded blank concentrations by a factor of 10 and other parameter concentrations that exceeded blank concentrations by a factor of five were considered to be site related. Parameters not meeting this criteria were considered artifacts from field or laboratory practices and treated as non-detects.

For Site 44, the following contaminants were found in the blanks: chloroform (4 µg/l), 2-butanone (29 µg/l), 1,2-dichloroethene (4 µg/l), trichloroethene (1 µg/l) and bis(2-ethylhexyl)phthalate (2 µg/l).

6.2.3.7 Federal and State Criteria and Standards

Contaminants detected at the site were compared to state and Federal standards, criteria, and/or To Be Considered levels (TBCs). These comparisons may provide some qualitative information as to the relative potential for health impacts resulting from the site. It should be noted that COPC concentration ranges were directly compared to each standard/criteria/TBC. This comparison did not take into account the additive or synergistic effects of those constituents without standards or criteria. Consequently, conclusions regarding potential risk posed by each site cannot be inferred from this comparison. A brief explanation of the standards/criteria/TBCs used for the evaluation of COPCs is presented in Section 6.2.3.

North Carolina Water Quality Standards (NCWQSS) - Groundwater - NCWQSS are the maximum allowable concentrations resulting from any discharge of contaminants to the land or waters of the state, which may be tolerated without creating a threat to human health or which otherwise render the groundwater unsuitable for its intended purpose.

Maximum Contaminant Levels (MCLs) - Federal Groundwater Standards - 40 CFR 161 - MCLs are enforceable standards for public water supplies promulgated under the Safe Drinking Water Act and are designed for the protection of human health. MCLs are based on laboratory or epidemiological studies and apply to drinking water supplies consumed by a minimum of 25 persons. They are designed for prevention of human health effects associated with a lifetime exposure (70-year lifetime) of an average adult (70 kg) consuming 2 liters of water per day. MCLs also consider the technical feasibility of removing the contaminant from the public water supply.

North Carolina Water Quality Standards (Surface Water) - The NCWQSS for surface water are the standard concentrations that, either alone or in conjunction with other wastes in surface waters, will neither render waters injurious to aquatic life, wildlife, or public health, nor impair the waters for any designated use.

Ambient Water Quality Criteria - AWQCs are non-enforceable regulatory guidelines and are of primary utility in assessing acute and chronic toxic effects in aquatic systems. They may also be used for identifying the potential for human health risks. AWQCs consider acute and chronic effects in both freshwater and saltwater aquatic life, and potential carcinogenic and noncarcinogenic health effects in humans from ingestion of both water (2 liters/day) and aquatic organisms (6.5 grams/day), or from ingestion of water alone (2 liters/day). The human health AWQCs for potential carcinogenic

substances are based on the USEPA's specified incremental cancer risk range of one additional case of cancer in an exposed population of 10,000,000 to 100,000 (i.e. the 10E-7 to 10E-5 range).

Region IV Sediment Screening Values - Currently, Federal sediment quality criteria for the protection of aquatic life are being developed. In the interim, the USEPA Region IV Waste Management Division recommends using sediment values, compiled by the National Oceanic and Atmospheric Administration (NOAA), as screening values for evaluating the potential for chemical constituents in sediments to cause adverse biological effects. NOAA developed this screening method through evaluating biological effects data for marine and freshwater organisms obtained through equilibrium partitioning calculations, spiked-sediment bioassays, and concurrent biological and chemical field surveys. For each constituent having sufficient data available, the concentrations causing adverse biological effects were arrayed, and the lower 10 percentile (called an Effects Range-Low, or ER-L) and the median (called an Effects Range-Median, or ER-M) were determined.

If sediment contaminant concentrations are above the ER-M, adverse effects on the biota are considered probable. If contaminant concentrations are between the ER-L and the ER-M, adverse effects are considered possible, and the USEPA recommends conducting sediment toxicity tests as a follow-up. If contaminant concentrations are below the ER-L, adverse effects are considered unlikely.

Health Advisories (HAs) - HAs are guidelines developed by the USEPA Office of Drinking Water for nonregulated constituents in drinking water. These guidelines are designed to consider both acute and chronic toxic effects in children (assumed body weight 10 kg) who consume 1 liter of water per day or in adults (assumed body weight 70 kg) who consume 2 liters of water per day. HAs are generally available for acute (1 day), subchronic (10 days), and chronic (longer-term) exposure scenarios. These guidelines are designed to consider only threshold effects and, as such, are not used to set acceptable levels of potential human carcinogens.

USEPA Region III COC Screening Values - COC screening values are derived using conservative USEPA promulgated default values and the most recent toxicological criteria available. COC screening values for potentially carcinogenic and noncarcinogenic chemicals are individually derived based on a target incremental lifetime cancer risk (ILCR) of 1×10^{-6} and a target hazard quotient of 0.1, respectively. For potential carcinogens, the toxicity criteria applicable to the derivation of COC screening values are oral and inhalation cancer slope factors; for non carcinogens, they are chronic oral and inhalation reference doses. These toxicity criteria are subject to change as more updated information and results from the most recent toxicological/epidemiological studies become available. Therefore, the use of toxicity criteria in the derivation of COC screening values requires that the screening concentrations be updated periodically to reflect changes in the toxicity criteria.

Since the most recent COC screening values table was issued by USEPA in March 1995, the values from these tables can be updated by incorporating information from another set of tables containing risk-based concentrations (RBCs) that are issued by USEPA Region III on a quarterly basis. The RBCs are derived using the same equations and USEPA promulgated default exposure assumptions that were used by Region III to derive the COC screening values. In addition, the quarterly RBCs for potentially carcinogenic chemicals are based on a target ILCR of 1×10^{-6} . The only difference in the derivation methodologies for the COC screening values and the RBCs is that the RBCs for noncarcinogens are based on a target hazard quotient of 1.0 rather than 0.1. The COC screening values for noncarcinogens are to be derived based on a target hazard quotient of 0.1, to account for

cumulative risk from multiple chemicals in a medium. Re-derivation of the quarterly noncarcinogenic RBCs based on a target hazard quotient of 0.1, while using the most recent toxicological criteria available, results in a set of values that can be used, as a COC screening values. In other words, an updated set of COC screening values can be attained each quarter by using the carcinogenic RBCs issued quarterly by USEPA Region III and dividing the accompanying noncarcinogenic RBCs by a factor of 10.

As stated previously, COPCs in all media of concern at the site were compared these aforementioned criteria. The results of the standards/criteria/TBC comparison for the site are presented in Tables 7-1 through 6-6.

6.2.4 Contaminants of Potential Concern (COPCs)

The following sections present an overview of the analytical data obtained for each medium and the subsequent retention or elimination of chemicals as COPCs using the aforementioned criteria for selection of COPCs.

6.2.4.1 Surface Soil

Thirteen surface soil samples were analyzed for VOCs. Acetone was detected at a maximum concentration less than the residential soil screening value. For that reason, it is not retained as a COPC.

Thirteen surface soil samples were analyzed for SVOCs. The following contaminants were detected at maximum concentrations below respective residential soil screening values: bis(2-chloroethyl)ether, 2,6-dinitrotoluene, bis(2-ethylhexyl)phthalate, indeno(1,2,3-cd)pyrene and benzo(g,h,i)perylene. For this reason, these contaminants are not retained as COPCs.

Thirteen surface soil samples were analyzed for pesticide/PCBs. 4,4'-DDE, 4,4'-DDD and 4,4'-DDT were detected at maximum concentrations less than respective residential soil RBC values. For this reason, these contaminants are not retained as COPCs.

Thirteen surface soil samples were analyzed for inorganic contaminants. Cobalt, nickel, selenium, and sodium are not retained as COPCs because maximum concentrations are less than respective background levels. The following contaminants were detected at maximum concentrations less than respective residential soil screening values: barium, chromium, copper, lead, manganese, vanadium, and zinc. For this reason, these contaminants are not retained as COPCs. Calcium, magnesium, and potassium are not retained as COPCs because these analytes are considered essential nutrients.

Aluminum (100%), arsenic (100%), copper (92%), and iron (100%) are retained as surface soil COPCs since they were detected frequently and maximum detected concentrations exceed corresponding residential soil screening values. Organic and inorganic results are summarized in Tables 6-1 and 6-2, respectively.

6.2.4.2 Subsurface Soil

Twelve subsurface soil samples were analyzed for VOCs. Acetone was detected at a maximum concentration less than the residential soil screening value. For this reason, it is not retained as a COPC.

Thirteen subsurface soil samples were analyzed for SVOCs. The following contaminants were detected at maximum concentrations less than respective residential soil screening values: bis(2-ethylhexyl)phthalate, indeno(1,2,3-cd)pyrene, and benzo(g,h,i)perylene. For this reason, these contaminants are not retained as COPCs.

Thirteen subsurface soil samples were analyzed for pesticide/PCBs. 4,4'-DDE, 4,4'-DDD, and 4,4'-DDT were detected at concentrations less than respective residential soil screening values. For this reason, these contaminants are not retained as COPCs.

Thirteen subsurface soil samples were analyzed for inorganic contaminants. The following inorganics were detected at concentrations less than respective residential soil screening values: copper, lead, manganese, nickel, vanadium, and zinc. Barium, chromium, magnesium, potassium, and sodium were detected at maximum concentrations less than respective background levels. Consequently, these contaminants are not retained as COPCs. Calcium is not retained as COPCs because these contaminants are considered essential nutrients.

Aluminum (100%), arsenic (77%), and iron (100%) were detected at maximum concentrations exceeding their respective residential soil screening values. As a result, these analytes are retained as subsurface soil COPCs. Organic and inorganic results are presented in Tables 6-3 and 6-4, respectively.

6.2.4.3 Shallow and Deep Groundwater

Nine groundwater samples were analyzed for VOCs. Trichloroethene and tetrachloroethene were detected at maximum concentrations less than respective tap water screening values. For this reason, these contaminants are not retained as COPCs. 1,2-Dichloroethene was detected in groundwater at a maximum concentration less than five times the concentration detected in the blanks (15 µg/l vs. 20 µg/l). For this reason, this VOC was not retained as a ground water COPC.

Vinyl chloride was detected in one of nine groundwater samples at a maximum concentration greater than its tap water screening value. Therefore, this VOCs are retained as groundwater COPCs.

Nine groundwater samples were analyzed for SVOCs. The following contaminants were detected at maximum concentrations less than respective tap water screening levels: naphthalene, 2-methylnaphthalene, acenaphthene, dibenzofuran, fluorene, phenanthrene, and bis(2-ethylhexyl)phthalate. For this reason, these contaminants are not retained as COPCs.

Carbazole, a potentially carcinogenic PAH, was detected in one of nine groundwater samples at a concentration exceeding its tap water screening value. As a result, this SVOC is retained as a groundwater COPC.

No pesticide/PCBs were detected in groundwater samples. Therefore, no pesticide/PCBs are retained as groundwater COPCs.

Nine groundwater samples were analyzed for inorganic contaminants. The following inorganics were detected at maximum concentrations less than respective tap water screening levels: aluminum, barium, chromium, cobalt, manganese, selenium, and zinc. Lead was detected at a maximum concentration less than its action level of 15 µg/l. For this reason, these contaminants are not retained

as COPCs. Calcium, magnesium, potassium, and sodium are not retained as COPCs because these inorganic contaminants are considered essential nutrients.

Arsenic and iron were detected at maximum concentrations exceeding their respective tap water screening values. Therefore, they were retained as groundwater COPCs. These results are shown in Table 6-5.

6.2.4.4 Surface Water

Sixteen surface water samples were analyzed for VOCs. Vinyl chloride, acetone, 1,1-dichloroethene, 1,2-dichloroethene (total), trichloroethene, 1,1,2-trichloroethane, and 1,1,2,2-tetrachloroethane were detected frequently in Site 44 surface water. These VOCs were retained as surface water COPCs.

Eight surface water samples were analyzed for SVOCs. Bis(2-ethylhexyl)phthalate and phenol were detected in surface water. Therefore, these SVOCs are retained as COPCs.

No pesticide/PCBs were detected in Site 44 surface water. Therefore, no pesticide/PCBs are retained as COPCs.

Eight surface water samples were analyzed for inorganic contaminants. Calcium, magnesium, potassium, and sodium are not retained as COPCs since these contaminants are considered essential nutrients.

Aluminum, barium, copper, iron, lead, manganese, nickel, vanadium and zinc were detected frequently in surface water samples. Aluminum, barium, and iron were detected at concentrations that exceed background levels. Thus, aluminum and barium are retained as surface water COPCs. Copper, lead, manganese, nickel, vanadium, and zinc were not detected in background samples. These analytes are also retained as surface water COPCs. A summary of these results is shown in Table 6-6.

6.2.4.5 Sediment

Sixteen sediment samples were analyzed for VOCs. Acetone and 2-butanone were detected in eleven of sixteen and two of sixteen samples, respectively. 2-Butanone was detected at a maximum concentration less than ten times the concentration detected in blanks (200 µg/l vs. 290 µg/l). Acetone was not detected in blanks. Therefore, acetone is retained as a sediment COPC while 2-butanone was eliminated.

Sixteen sediment samples were analyzed for SVOCs. The following contaminants are retained as sediment COPCs due to their frequency and/or toxicity: pentachlorophenol, phenanthrene, carbazole, fluoroanthene, pyrene, butylbenzylphthalate, benzo(a)anthracene, chrysene, bis(2-ethylhexyl)phthalate, benzo(b)fluoranthene, benzo(k)fluoranthene, benzo(a)pyrene, and benzo(g,h,i)perylene.

Sixteen sediment samples were analyzed for pesticide/PCBs. Aldrin, heptachlor epoxide, 4,4'-DDE, 4,4'-DDD, 4,4'-DDT, alpha-chlordane, and gamma-chlordane were detected frequently and above background levels. Thus, these contaminants are retained as sediment COPCs.

Sixteen sediment samples were analyzed for inorganic contaminants. Calcium, magnesium, potassium, and sodium are not retained as COPCs because these analytes are considered essential nutrients.

Aluminum, arsenic, barium, beryllium, cadmium, chromium, copper, iron, lead, manganese, selenium, silver, vanadium, and zinc were detected frequently and at concentrations exceeding background levels. Cobalt and nickel were also detected frequently but were not detected in background samples. Therefore, these inorganic contaminants are retained as sediment COPCs. These results are presented in Table 6-7.

6.3 Exposure Assessment

The exposure assessment addresses each potential exposure pathway via soil (surface and subsurface), groundwater, surface water, sediment, biota, and air. To determine the likelihood of human exposure via these pathways in the absence of remedial action, an analysis including the identification and characterization of exposure pathways was conducted. The following four elements were examined to determine if a complete exposure pathway was present:

- 1) a source and mechanism of chemical release
- 2) an environmental transport medium
- 3) a feasible receptor exposure route
- 4) a receptor exposure point

The exposure scenarios presented in the following sections are used to estimate individual risks. Unless otherwise noted, all the statistical data associated with the factors used in the dose evaluation equations for assessing exposure were obtained from the Exposure Factors Handbook (USEPA, 1989b) and the accompanying guidance manuals. A reasonable maximum exposure (RME) scenario was utilized in this assessment, which is consistent with USEPA Region IV recommendations regarding human health risk assessment. As a result, the exposure scenarios presented include RME assumptions for the input parameters in the dose evaluation equations. These values are summarized in Table 6-8.

A mathematical model was used to estimate exposure from the inhalation of volatile contaminants in groundwater while showering, the "Integrated Household Exposure Model for Use of Tap Water Contaminated with Volatile Organic Chemicals," developed by S.A. Foster and P.C. Chrostowski, was applied. This model is presented in Appendix Q.

6.3.1 Potential Human Receptors and Adjacent Populations

The following sections provide a discussion of the potential exposure pathways and receptors at Site 44.

6.3.1.1 Site Conceptual Model for Site 44

A site conceptual model of potential sources, migration pathways and human receptors was developed to encompass all current and future potential routes of exposure at the site. This document is presented in Appendix R. Figure 6-1 presents the potential exposure pathways and receptors for Site 44. Qualitative descriptions of current and future land use patterns in the vicinity

of OU No. 6 were provided in the model. All available analytical data and meteorological data were considered in addition to general understanding of the demographics of surrounding communities.

From this information, the following general list of potential receptors was developed for inclusion in the quantitative health risk analysis for Site 44:

- Current military personnel
- Current trespassers (young child and adult)
- Future on-site residents (young child and adult)
- Future construction worker

The following sections present a discussion of the potential exposure pathways and receptors at Site 44.

6.3.1.2 Current and Future Scenarios

Site 44 no longer serves as a municipal waste dump. Currently, Site 44 has no official use.

Receptors exposed to surface soil include: future residents (i.e., young children and adults), current military personnel, and current trespassers (i.e., young children and adults) from adjacent, off-site residences. These residences are base housing units along Jones Street that border the site to the south. The young child receptor is one to six years of age. Surface soil exposure pathways for these receptors include incidental ingestion, dermal contact, and inhalation of fugitive dust.

Future construction workers are the only receptors exposed to subsurface soil. Exposure to subsurface soil may occur during ground excavation for on-site construction activities. Exposure pathways include incidental ingestion of subsurface soil, dermal contact with subsurface soil and inhalation of fugitive dust.

Presently, Site 44 groundwater is not used as a potable supply. For this reason, current groundwater exposure is not evaluated. In a future scenario, it is possible that residential developments may be constructed at Site 44. Consequently, future groundwater exposure was assessed for residential children and adults. Groundwater exposure was not evaluated for future military personnel. Groundwater exposure pathways include ingestion, dermal contact with groundwater and inhalation of volatilized constituents while showering.

In addition, the shallow and deep groundwater at Site 44 were evaluated as a single exposure source. Although shallow groundwater is not used potably at the sites, it has been shown that there is a potential interconnection between the shallow and deep aquifers (see Section 3.0). Consequently, exposure to both sources of groundwater were evaluated as one unit.

Receptors exposed to surface water and sediment are current on-site trespassers and future residents (i.e., child and adult). It should be noted that the two water bodies at Site 44, Edwards Creek and the unnamed tributary, were evaluated as one source because the tributary flows into Edwards Creek. Exposure pathways for these receptors are incidental ingestion of surface water/sediment and dermal contact with surface water/sediment. For evaluation purposes, a wading scenario is assumed.

Figure 6-1 presents a flowchart of the potential exposure pathways and receptors at Site 44.

6.3.2 Migration and Exposure Pathways

In general, the migration of COPCs from site soil sources could potentially occur by the following routes:

- Vertical migration of potential contaminants from surficial soils to subsurface soils.
- Leaching of potential contaminants from subsurface soils to the water-bearing zones.
- Vertical migration from shallow water-bearing zones to deeper flow systems.
- Horizontal migration in groundwater in the direction of groundwater flow.
- Groundwater discharge into local streams.
- Wind erosion and subsequent deposition of windblown dust.

The potential for a constituent to migrate spatially and persist in environmental media is important in the estimation of potential exposure. This section describes the potential exposure pathways presented on Figure 6-1 associated with each medium and each potential human receptor group, then qualitatively evaluates each pathway for further consideration in the quantitative risk analysis. Table 6-9 presents the potential human exposure scenarios for this site.

6.3.2.1 Surface Soil

The potential release source considered in the soil pathway was the chemical residuals in the surface soils. The release mechanisms considered were volatilization, fugitive dust generation/deposition, leaching, and surface runoff. The transport media were the surface soils and air. The routes for human exposure to the contaminated soils included inhalation, ingestion, and dermal contact. Potential exposure points from the site were areas of human activity on and adjacent to the site.

Soil Ingestion and Dermal Contact

Incidental ingestion and dermal contact with surface soil in the current case are complete exposure pathways at Site 44. These exposure pathways were evaluated for current military personnel, current adult and child trespassers, and future adult and child residents.

Soil Inhalation Via Volatilization

Surface soil represents a potential source of exposure at the site via volatilization of organic COPCs. The potentially exposed populations included current military personnel, current trespassers, future residents. Future construction workers may inhale volatilized COPCs emanating from excavated subsurface soil. However, no VOCs were identified as COPCs in either surface or subsurface soil at the site. As a result, this pathway was not considered to be significant for the site and was not evaluated for soils.

Soil Inhalation Via Fugitive Dust Generation

The surface soils in the current case and the subsurface soils in the future case represent a potential source of exposure at the site via fugitive dust generation from wind erosion and vehicular traffic on surface soils. Current military personnel, trespassers, future residents, and future construction workers (subsurface soil) may inadvertently inhale the contaminated particulates as dust while engaging in outdoor activities.

6.3.2.2 Subsurface Soil

The potential release source considered in the subsurface soil pathway was the chemical residuals in the contaminated soils. The release mechanism considered is leaching to groundwater. The transport medium was the groundwater infiltrating the subsurface soil. Therefore, exposure to subsurface soils would be indirect (i.e., leaching of contaminants to groundwater). As such, subsurface soil exposure was addressed in the groundwater pathway analysis. Additionally, subsurface soil exposure was mentioned as part of the soil medium. It is assumed that the subsurface soil would be excavated and used as surface grading, landscaping, etc., in the foreseeable future. As a result, exposure to subsurface soil via ingestion, dermal contact, and inhalation was evaluated for the construction worker receptor. It was assumed that this exposure would result from outdoor construction activities.

6.3.2.3 Groundwater

The potential release source considered in evaluating the groundwater pathway was contaminated soils. The release mechanism considered was soil leaching. The transport medium was the groundwater. The routes considered for human exposure to the groundwater were direct ingestion of groundwater, dermal contact during showering, and inhalation of volatilized contaminants during showering.

Residences located on-site in the future scenario were considered to be potential exposure points. At present, on-site groundwater is not potable. As a result, groundwater exposure from on-site sources is not significant and was not evaluated for potential risk in the current scenario. In the future scenario, it is conservatively assumed that a potable well will be installed on-site. However, as stated previously, it is not expected that this residential scenario will be implemented in the future at these military sites. However, future groundwater risks on-site were assessed conservatively in accordance with guidance.

6.3.2.4 Surface Water

Potential release sources considered in evaluating the surface water pathway were the contaminated soils and groundwater. The release mechanisms considered were surface runoff and groundwater seepage. The transport medium was the surface water. The potential routes considered for human exposure to the contaminated surface water were incidental ingestion and dermal contact. Potential exposure points were areas of human activity on and adjacent to the site. At Site 44 children and adults were evaluated for exposure to surface water during wading activities from Edwards Creek and an unnamed tributary to Edwards Creek.

6.3.2.5 Sediment

The chemical residuals in the contaminated soils and groundwater were the potential release sources to be considered in the sediment pathway. The routes for human exposure to the contaminated sediments by the sediment pathway included ingestion and dermal contact. Potential exposure points from the site were areas of human activity adjacent to the site.

The receptors previously described for evaluation of surface water exposure pathways were assumed to also come in contact with the underlying sediment while engaging in outdoor activities.

Consequently, the receptors identified for the surface water exposure pathway were also evaluated for exposure to sediment in the current and future scenarios.

6.3.2.6 Air

There are two potential release mechanisms to be considered in evaluating the atmospheric pathway: release of contaminated particulates (i.e., fugitive dust generation) and volatilization of contaminants from soil and groundwater. The transport mechanism is the air, and the potential exposure points are the areas of human activity on and adjacent to the site.

Fugitive Dust Generation

This air pathway was evaluated as a source of exposure outdoors at the site via fugitive dust generation of contaminants. Air exposure may occur when surface soils become airborne due to wind erosion or vehicular traffic. It is assumed that military personnel, child and adult receptors, and the construction worker may inhale soil particulates while engaging in outdoor activities. This is applicable for both the current and future cases. This exposure pathway is further assessed in Section 6.3.2.

Volatilization

The air pathway, specifically, volatilization of contaminants from groundwater, is a potential source of contaminant exposure. It is assumed in the future scenario that an adult and child receptor will inhale volatilized contaminants present in groundwater while showering. This pathway is further discussed in Section 6.3.2, Exposure Pathways, under Groundwater. Also, see the section on Surface Soil for a discussion of the volatilization of contaminants from surface soil.

6.3.2.7 Biota

The potential release sources to be considered in evaluating exposure via biota (such as fish and crab) consumption are contaminated surface water and sediments. Biota can uptake contaminants present in these media by bioaccumulation and biomagnification. The exposure route for human receptors is ingestion.

At Site 44, collection of biota samples was not in the scope of work. Consequently, biota consumption was not evaluated as an exposure pathway for Site 44.

6.3.3 Quantification of Exposure

The concentrations used in the estimation of chronic daily intakes (CDIs) must be representative of the type of exposure being considered. Exposure to groundwater, sediments, and surface waters can occur discretely or at a number of sampling locations. These media are transitory in that concentrations change frequently over time. Averaging transitory data obtained from multiple locations is difficult and requires many more data points at discrete locations than exist within this site. As a result, the best way to represent groundwater, sediment, and surface water contaminants from an exposure standpoint is to use a representative exposure concentration. Soils are less transitory than the aforementioned media and in most cases, exposure occurs over a wider area (i.e., residential exposure). Therefore, an upper confidence interval was used to represent a soil exposure concentration. Soil data collected from each of these areas was used separately in

estimating the potential human health risks under current and future exposure scenarios. The human health assessment for future groundwater use considered groundwater data collected from all of the monitoring wells within a site and estimated risks to individuals per area of concern.

The manner in which environmental data are represented depends on the number of samples and sampling locations available for a given area and a given medium. Ninety-fifth percent (95%) upper confidence limit (UCL) values of the arithmetic mean for a lognormal distribution were used as exposure point concentrations for surface, subsurface soil, groundwater, surface water, and sediment. For the sake of conservatism, the 95 percent UCL for the lognormal distribution was used for each contaminant in a given data set for quantifying potential exposure. For exposure areas with limited amounts of data or extreme variability in measured data, the 95 percent UCL can be greater than the maximum measured concentration; therefore, in cases where the 95 percent UCL for a contaminant exceeds the maximum detected value in a given data set, the maximum result was used in the estimate of exposure of the 95 percent UCL. However, the true mean may still be higher than this maximum value (i.e., the 95 percent UCL indicates a higher mean is possible), especially if the most contaminated portion of the site has not been sampled.

The 95 % UCL of the lognormal distribution was calculated using the following equation (USEPA, 1992b):

$$UCL = \exp(\bar{x} + sH/\sqrt{n-1})$$

where:

UCL	=	upper confidence limit
exp	=	constant (base of the natural log, equal to 2.718)
\bar{x}	=	mean of the transformed data
s	=	standard deviation of the transformed data
H	=	H-statistic
n	=	number of samples

The following criteria were used to calculate media-specific average concentrations for each parameter that was detected at least once:

- For results reported as "non-detect" (e.g., ND, U, etc.), a value of one-half of the sample-specific detection limit was used to calculate the mean. The use of one-half the detection limit commonly is assigned to non-detects when averaging data for risk assessment purposes, since the actual value could be between zero and a value just below the detection limit.
- Reported concentrations that were less than the detection limit were used to calculate the mean. Typically, these values are qualified with a "J" meaning that the value was estimated.
- The organic analytical results qualified with a "B" were not retained in the data set. The "B" qualifier means that the detected concentration was less than either five times or ten times the blank concentration (i.e., the 5-10 rule), depending upon the parameter. Common laboratory contaminants, such as phthalate esters, toluene,

methylene chloride, methyl ethyl ketone, and acetone, follow the five times rule, while all other parameters follow the ten times rule (USEPA, 1989).

- Reported concentrations qualified with "R" were excluded from the data set. The data flag "R" means that the QA/QC data indicated that analytical results were not usable for quantitative purposes.

The reduced data were summarized by medium and analytical parameter type (i.e., organics and inorganics) for the site. For each parameter detected during the sampling programs, the frequency of detection, maximum concentration, minimum concentration, average (arithmetic mean) concentration, and both the normal and lognormal upper 95 percent level for the arithmetic average were summarized. It should be noted that the number of times analyzed may differ per parameter per media per area of concern. This is primarily due to data rejected due to QA/QC problems and excluded from the data set. Consequently, these data are not reflected in the number of times analyzed. Data and frequency summaries and statistical summaries are presented in Appendices H and I, respectively.

6.3.4 Calculation of Chronic Daily Intakes

In order to numerically estimate the risks for current and future human receptors at Site 44, a CDI must be estimated for each COPC in every retained exposure pathway. Appendix S contains the specific CDI equations for each exposure scenario of interest. These equations were obtained from USEPA guidance (USEPA, 1989).

The following paragraphs present the general equations and input parameters used in the calculation of CDIs for each potential exposure pathway. Input parameters were taken from USEPA's default exposure factors guidelines where available and applicable. All inputs not defined by USEPA were derived from USEPA documents concerning exposure or from best professional judgment. All exposure assessments incorporate the representative contaminant concentrations in the estimation of intakes. Therefore, only one exposure scenario was developed for each exposure route/receptor combination.

CDIs calculated for carcinogens incorporate terms to represent the exposure duration (years) over the course of a lifetime (70 years, or 25,550 days). CDIs for noncarcinogens, on the other hand, were estimated using the concept of an average annual exposure. The intake incorporates terms describing the exposure time and/or frequency representing the number of hours per day and the number of days per year that exposure occurs. In general, noncarcinogenic risks for many exposure routes (e.g., soil ingestion) are greater for children than adults because of the differences in body weights, similar exposure frequencies, and higher ingestion rates.

Future residential exposure scenarios consider 1 to 6 year old children weighing 15 kg and adults weighing 70 kg on average (USEPA, 1989). For current military personnel, an exposure duration of 4 years was used to estimate a military residence. A one-year duration was used for future construction worker exposure scenarios.

6.3.4.1 Incidental Ingestion of Soil

The CDIs for COPCs detected in soil was estimated for all potential human receptors and was expressed as:

$$CDI = \frac{C \times IR \times CF \times Fi \times EF \times ED}{BW \times AT}$$

Where:

C	=	Contaminant concentration in soil (mg/kg)
IR	=	Ingestion rate (mg/day)
CF	=	Conversion factor (1x10 ⁻⁶ kg/mg)
Fi	=	Fraction ingested from source (dimensionless)
EF	=	Exposure frequency (days/year)
ED	=	Exposure duration (years)
BW	=	Body weight (kg)
AT	=	Averaging time (days)

The following paragraphs discuss the exposure assumptions used in the estimation of exposure to COPCs associated with the potential ingestion of soils.

Military Personnel

During the course of daily activities at Site 44, military personnel could potentially be exposed to COPCs by the incidental ingestion of surface soils. The IR for military personnel exposed to surficial soils was assumed to be 100 mg/day (USEPA, 1989), and the fraction ingested was assumed to be 100 percent. An exposure frequency (EF) of 250 days per year (USEPA, 1991) was used in conjunction with an exposure duration of 4 years. An averaging time (AT) of 70 years or 25,550 days was used for exposure to potentially carcinogenic compounds while an averaging time of 1,460 (4 years x 365 days/year) days was used for noncarcinogenic exposures. An adult average body weight (BW) of 70 kg was used (USEPA, 1989).

Trespassers

Current trespassers could potentially be exposed to COPCs in the surficial soils while outdoors. Children and adults could potentially be exposed to COPCs in soils by incidental ingestion via hand to mouth contact. Ingestion rates (IR) for adults and children in this scenario were assumed to be 100 mg/day and 200 mg/day, respectively (USEPA, 1991). EFs for the receptor groups were assumed to be 130 days per year (child) and 43 days/year (adult) (USEPA, 1992). These values represent exposure frequencies of individuals who spend a limited amount of time on-site. The exposure duration (ED) was 6 years (child) and 30 years (adult) (USEPA, 1991). Averaging times of 25,550 days for potential carcinogens and 10,950 days (30 years x 365 days/year) for noncarcinogenic constituents were used for estimating potential CDIs for adults. An AT of 2,190 days (6 years x 365 days/year) was used to estimate potential CDIs for children potentially exposed to noncarcinogens.

Future On-Site Residents

Future on-site residents could potentially be exposed to COPCs in the surficial soils during recreational or landscaping activities around their homes. Children and adults could potentially be exposed to COPCs in soils by incidental ingestion via hand to mouth contact. Ingestion rates (IR) for adults and children in this scenario were assumed to be 100 mg/day and 200 mg/day, respectively. EFs for both receptor groups were assumed to be 350 days per year (USEPA, 1991).

The residential exposure duration (ED) was divided into two parts. First, a six-year exposure duration was evaluated for young children which accounts for the period of highest soil ingestion (200 mg/day), and second a 30-year exposure was assessed for older children and adults by using a lower soil ingestion rate (100 mg/day) (USEPA, 1991). The BW for a resident child was assumed to be 15 kg, representing younger individuals. The rationale was that the younger child (1 to 6 years), as a resident, will have access to affected on-site soils. The body weight for the future resident adult is assumed to be 70 kg. Averaging times of 25,550 days for potential carcinogens and 10,950 days (30 years x 365 days/year) for noncarcinogenic constituents was used for estimating potential CDIs for adults. An AT of 2,190 days (6 years x 365 days/year) was used to estimate potential CDIs for children potentially exposed to noncarcinogens.

Construction Worker

During excavation activities, construction workers may be exposed to COPCs through the incidental ingestion of subsurface soil. The IR for future construction workers exposed to subsurface soils was assumed to be 480 mg/day (USEPA, 1991). An exposure frequency of 90 days per year was used in conjunction with an exposure duration of one year (USEPA, 1991). An adult BW of 70 kg was used.

A summary of the exposure factors used in the estimation of soil CDIs associated with incidental ingestion is presented in Table 6-8.

6.3.4.2 Dermal Contact with Soil

CDIs associated with potential dermal contact of soils containing COPCs were expressed using the following equation:

$$CDI = \frac{C \times CF \times SA \times AF \times ABS \times EF \times ED}{BW \times AT}$$

Where:

- C = Contaminant concentration in soil (mg/kg)
- CF = Conversion factor (kg/mg)
- SA = Skin surface available for contact (cm²)
- AF = Soil to skin adherence factor (1.0 mg/cm²)
- ABS = Absorption factor (dimensionless) - 0.01 for organics, 0.001 inorganics (USEPA, Region IV, 1992d)
- EF = Exposure frequency (days/year)
- ED = Exposure duration (years)
- BW = Body weight (kg)
- AT = Averaging time (days)

The following paragraphs discuss the exposure assumptions used in the estimation of exposure to COPCs from dermal contact with soils.

Military Personnel

There is a potential for base personnel to absorb COPCs by dermal contact. The exposed skin surface area (4,300 cm²) was limited to the head (1,180 cm²), arms (2,280 cm²), and hands (840 cm²) (USEPA, 1992). Values for exposure duration (ED), exposure frequency (EF), body weight (BW), and averaging time (AT) were the same as those used for the incidental ingestion of soil scenario. The values for AF and ABS were provided above and are in accordance with USEPA and Region IV guidance.

Trespassers

Current trespassers could be potentially exposed to COPCs in on-site soil through dermal contact experienced during activities near their homes. Skin surface areas (SA) used in this exposure scenario were developed for a reasonable worst case scenario for an individual wearing a short-sleeved shirt, shorts, and shoes. The exposed skin surface area was limited to the head, hands, forearms, and lower legs. Thus, applying 25 percent of the average total body surface area results in a default of 5,000 cm² for adults. The exposed skin surface for a child (2,000 cm²) was estimated using an average of the 50th (0.866 m²) percentile body surface for a six year old child multiplied by 25 percent (USEPA, 1992). The mean is used due to the more limited exposure a trespasser would have as compared to a resident. Exposure duration, exposure frequencies, body weights, and averaging times were the same as those discussed for the incidental ingestion scenario presented previously. The values for AF and ABS were provided above and are in accordance with USEPA and Region IV guidance.

Future On-Site Residents

Future on-site residents could also be potentially exposed to COPCs in on-site soil through dermal contact experienced during activities near their homes. It was assumed that residents would spend more recreational time in contact with site media than trespassers and, consequently, would make more skin surface area available for exposure. Thus, applying 25 percent of the total body surface area results in a default of 5,800 cm² for adults. The exposed skin surface for a child (2,300 cm²) was estimated using an average of the 50th (0.866 m²) and the 95th (1.06 m²) percentile body surface for a six year old child multiplied by 25 percent (USEPA, 1992). Exposure duration, exposure frequencies, body weights, and averaging times were the same as those discussed for the incidental ingestion scenario presented previously. The values for AF and ABS were provided above and are in accordance with USEPA and Region IV guidance.

Construction Worker

Dermal contact with subsurface soil COPCs could potentially occur during excavation activities. Skin surface area (SA) used for the construction worker exposure scenario were developed for an individual wear a short-sleeved shirt, long pants, and boots. The exposed skin surface area (4,300 cm²) was limited to the head (1,180 cm²), arms (2,280 cm²), and hands (840 cm²) (USEPA, 1992). The exposure frequency and exposure duration are the same as those discussed for incidental ingestion of subsurface soil. The values for AF and ABS were provided above and are in accordance with USEPA and Region IV guidance.

A summary of the soil exposure assessment input parameters for dermal contact is presented in Table 6-8.

6.3.4.3 Inhalation of Fugitive Particulates

Exposure to fugitive particulates was estimated for future residents, base personnel, trespassers, and construction workers. These populations may be exposed during daily recreational or work-related activities. The CDIs of contaminants associated with the inhalation of particulates was estimated using the following equation:

$$CDI = \frac{C \times IR \times ET \times EF \times ED \times 1/PEF}{BW \times AT}$$

Where:

C	=	Contaminant concentration in soil (mg/kg)
IR	=	Inhalation rate (m ³ /day)
EF	=	Exposure frequency (days/year)
ED	=	Exposure duration (years)
PEF	=	Particulate emission factor (1.32x10 ⁹ m ³ /kg)
BW	=	Body weight (kg)
AT	=	Averaging time (days)

The PEF relates the concentration in soil with the concentration of respirable particles in the air from fugitive dust emission. This relationship is derived by Cowherd (1985). The particulate emissions from contaminated sites are caused by wind erosion, and, therefore, depend on erodibility of the surface material. The value of 1.32E+09 m³/kg that is used was obtained from the final Soil Screening Level Guidance to be published by the USEPA in 1996 (USEPA, 1995c).

The following paragraphs discuss the exposure assumptions used in the estimation of exposure to COPCs from the inhalation of particulates.

Military Personnel

During work related activities, military personnel may inhale surface soil COPCs emitted as fugitive dust. An inhalation rate 30 m³/day was used for military personnel (USEPA, 1991). Values for exposure duration, exposure frequency, body weight, and averaging time were the same as those used for the incidental ingestion scenario.

Trespassers

Trespassers may also inhale surface soil particulates. Inhalation rates (IR) used in this exposure scenario were 20 m³/day (USEPA, 1989) and 15 m³/day (USEPA, 1995d) for adults and children, respectively. Exposure frequencies, duration, body weights, and averaging time were the same as those used for the incidental ingestion scenario. Table 6-8 presents the exposure factors used to estimate CDIs associated with the particulate inhalation scenario.

Future On-Site Residents

Future on-site residents may also inhale surface soil particulates. Inhalation rates (IR) used in the on-site resident exposure scenario were 20 m³/day (USEPA, 1989) and 15 m³/day (USEPA, 1995d) for adults and children, respectively. Exposure frequencies, duration, body weights, and averaging time were the same as those used for the incidental ingestion scenario. Table 6-8

presents the exposure factors used to estimate CDIs associated with the particulate inhalation scenario.

Construction Worker

Construction workers could become exposed to subsurface soil particulates during excavation activities. The inhalation rate (IR) used was 20 m³/day (USEPA, 1989). Exposure frequencies, duration, body weight, and averaging time were the same as those used for the soil incidental ingestion scenario. Table 6-8 presents the exposure factors used to estimate CDIs associated with the particulate inhalation scenario.

6.3.4.4 Ingestion of Groundwater

As stated previously, shallow groundwater is not currently being used as a potable supply at Site 44. Development of the shallow aquifer for potable use is unlikely because of its general water quality and poor flow rates. However, residential housing could be constructed in the future, and groundwater may be used for potable purposes.

The CDIs of contaminants associated with the future potential consumption of groundwater was estimated using the following general equation:

$$CDI = \frac{C \times IR \times EF \times ED}{BW \times AT}$$

Where:

C	=	Contaminant concentration in groundwater (mg/L)
IR	=	Ingestion rate (L/day)
EF	=	Exposure frequency (days/year)
ED	=	Exposure duration (years)
BW	=	Body weight (kg)
AT	=	Averaging time (days)

The following paragraphs discuss the exposure assumptions used in the estimation of exposure to COPCs from the ingestion of groundwater.

Future On-Site Residents

Exposure to COPCs via ingestion of groundwater was retained as a potential future exposure pathway for both children and adults. An IR of 1.0 L/day was used for the amount of water consumed by a 1 to 6 year old child weighing 15 kg. This ingestion rate provides a conservative exposure estimate (for systemic, noncarcinogenic toxicants) designed to protect young children who may be more affected than adolescents, or adults. This value assumes that children obtain all the tap water they drink from the same source for 350 days/year (which represents the exposure frequency [EF]). An averaging time (AT) of 2,190 days (6 years x 365 days/year) is used for noncarcinogenic compound exposure. The ingestion rate (IR) for adults was 2 liters/day (USEPA, 1989a). The ED used for the estimation of adult CDIs was 30 years (USEPA, 1989), which represents the national upper-bound (90th percentile) time at one residence. The averaging time for noncarcinogens was 10,950 days. An averaging time (AT) of 25,550 days (70 years x 365 days/year) was used to evaluate exposure for both children and adults to potential

carcinogenic compounds. Table 6-8 presents a summary of the input parameters for the ingestion of groundwater scenarios.

6.3.4.5 Dermal Contact with Groundwater

The CDIs associated with dermal contact with groundwater COPCs was estimated using the following general equation:

$$CDI = \frac{C \times SA \times PC \times ET \times EF \times ED \times CF}{BW \times AT}$$

Where:

C	=	Contaminant concentration in groundwater (mg/L)
SA	=	Surface area available for contact (cm ²)
PC	=	Dermal permeability constant (cm/hr)
ET	=	Exposure time (hour/day)
EF	=	Exposure frequency (days/year)
ED	=	Exposure duration (years)
CF	=	Conversion factor (1 L/1000 cm ³)
BW	=	Body weight (kg)
AT	=	Averaging time (days)

The following paragraphs discuss the exposure assumptions used in the estimation of exposure to COPCs from dermal contact with groundwater.

Future On-Site Residents

Children and adults could contact COPCs through dermal contact with groundwater while bathing or showering. It was assumed that bathing would take place 350 days/year using site groundwater as the sole source. The whole body skin surface area (SA) available for dermal absorption was estimated to be 10,000 cm² for children and 23,000 cm² for adults (USEPA, 1992). The permeability constant (PC) reflects the movement of a chemical across the skin and into the blood stream. The permeability of a chemical is an important property in evaluating actual absorbed dose, yet many compounds do not have literature PC values. For contaminants in which a PC value has not been established, the permeability constant was calculated (see Appendix Q). An exposure time (ET) of 0.25 hour/day was used to conservatively estimate the duration of bathing or showering. The exposure duration, body weight, and averaging time were the same as those used for the ingestion of groundwater scenario. Table 6-8 presents the exposure factors used to estimate CDIs associated with the future dermal contact with COPCs in groundwater.

6.3.4.6 Inhalation of Volatile Organics While Showering

In order to quantitatively assess the inhalation of contaminants volatilized from shower water, the model developed by Foster and Chrostowski (1986) was utilized (see Appendix Q). Contaminant concentrations in air were modeled by estimating the following: the rate of chemical releases into air (generation rate), the buildup of VOCs in the shower room air while the shower was on, the decay of VOCs in the shower room after the shower was turned off, and the quantity of airborne VOCs inhaled while the shower was both on and off. The contaminant concentrations calculated to be in the air were then used as the concentration term.

The CDIs associated with the inhalation of airborne (vapor phase) VOCs from groundwater while showering were estimated using the following general equation:

$$CDI = \frac{C \times IR \times ET \times EF \times ED}{BW \times AT}$$

Where:

C	=	Contaminant concentration in air (mg/m ³)
IR	=	Inhalation rate (m ³ /hr)
ET	=	Exposure time (hr/day)
EF	=	Exposure frequency (days/year)
ED	=	Exposure duration (years)
BW	=	Body weight (kg)
AT _c	=	Averaging time carcinogen (days)
AT _{nc}	=	Averaging time noncarcinogen (days)

Future On-Site Residents

Both children and adults may inhale vaporized volatile organic COPCs while showering. It was assumed that showering would take place 350 days/year, using site groundwater as the sole source, for children weighing 15 kg, and adults weighing 70 kg (USEPA, 1989). An inhalation rate of 0.6 m³/hr was used for both receptors (USEPA, 1989). An exposure time of 0.25 hrs/day was used for both receptors (USEPA, 1989). The exposure duration and averaging times remained the same as for groundwater ingestion. Table 6-8 presents the exposure factors used to estimate CDIs associated with the inhalation of VOCs from groundwater while showering.

6.3.4.7 Incidental Ingestion of Surface Water

The CDIs for contaminants associated with incidental ingestion of surface water were expressed using the following equation:

$$CDI = \frac{C \times IR \times ET \times EF \times ED}{BW \times AT}$$

Where:

C	=	Contaminant concentration in surface water (mg/L)
IR	=	Ingestion rate (L/day)
ET	=	Exposure time (hours/day)
EF	=	Exposure frequency (days/year)
ED	=	Exposure duration (years)
BW	=	Body weight (kg)
AT	=	Averaging time (days)

The following paragraphs discuss the exposure assumptions used in the estimation of exposure to COPCs from the incidental ingestion of surface water.

Current Trespassers and Future Residents

Adults and children who may potentially come into contact with the surface water were assumed to conservatively ingest surface water at a rate of 0.005 L/hour (USEPA, 1989). In addition, an exposure frequency (EF) of 45 days/year (9 days/month x 5 months), an ET of 2.6 hours/day and an exposure duration (ED) of 6 years (age 1-6) for a child, and 30 years for an adult were used (USEPA, 1989).

A summary of the surface water exposure factors associated with incidental ingestion of surface water is presented in Table 6-8.

6.3.4.8 Dermal Contact with Surface Water

The CDIs of contaminants associated with dermal contact of surface water were determined using the following general equation:

$$CDI = \frac{C \times CF \times SA \times PC \times ET \times EF \times ED}{BW \times AT}$$

Where:

C	=	Contaminant concentration in surface water (mg/L)
CF	=	Conversion factor (0.001L/cm ³)
SA	=	Surface area available for contact (cm ²)
PC	=	Chemical-specific dermal permeability constant (cm/hr)
ET	=	Exposure time (hour/day)
EF	=	Exposure frequency (days/year)
ED	=	Exposure duration (years)
BW	=	Body weight (kg)
AT	=	Averaging time (days)

The following paragraphs discuss the exposure assumptions used in the estimation of exposure to COPCs from dermal contact with surface water.

Current Trespassers and Future Residents

The SA values for adults and children who may potentially come into contact with the surface water while wading were assumed to be 5,800 and 2,300 cm², respectively, as previously described in the soil exposure scenario. In the case of the adult and child trespasser, the exposed SA values were assumed to be 5,000 cm² and 2,000 cm², respectively. In addition, an exposure frequency (EF) of 45 days/year (9 days/month x 5 months) and an exposure duration (ED) of 6 years (age 1-6) for a child, and 30 years for an adult were used (USEPA, 1989). It was conservatively assumed that 2.6 hours/day would be the exposure time for these receptors. The values for PC were chemical-specific. For COPCs with no PC values available, the values were calculated (see Appendix Q). The exposure factors for this potential exposure pathway are summarized in Table 6-8.

6.3.4.9 Incidental Ingestion of Sediment

The CDIs of COPCs associated with the incidental ingestion of sediment was expressed using the following general equation:

$$CDI = \frac{C \times CF \times IR \times EF \times ED}{BW \times AT}$$

Where:

C	=	Contaminant concentration in sediment (mg/kg)
CF	=	Conversion factor (1x10 ⁻⁶ kg/mg)
IR	=	Ingestion rate of sediment (mg/day)
EF	=	Exposure frequency (days/year)
ED	=	Exposure duration (years)
BW	=	Body weight (kg)
AT	=	Averaging time (days)

The following paragraphs discuss the exposure assumptions used in the estimation of exposure to COPCs from incidental ingestion of sediments.

Current Trespassers and Future Residents

Incidental ingestion of COPCs in sediments is also possible during activities occurring in the surface water bodies at Site 44, specifically Strawhorn Creek and Edwards Creek. Ingestion rates (IR) of 200 mg/day and 100 mg/day, respectively, were used in calculating the chronic daily intake for children and adults. The exposure frequency (EF) of 45 days/year (9 days/month x 5 months) was used as a conservative site-specific assumption. An exposure duration (ED) of 6 years and 30 years was used in the estimation of potential COPCs for a child and adult, respectively. A summary of exposure factors for this scenario is presented in Table 6-8.

6.3.4.10 Dermal Contact with Sediment

The CDIs of contaminants associated with the dermal contact of site sediments was expressed using the following general equation:

$$CDI = \frac{C \times CF \times SA \times AF \times ABS \times EF \times ED}{BW \times AT}$$

Where:

C	=	Contaminant concentration in sediment (mg/kg)
CF	=	Conversion factor (1x10 ⁻⁶ kg/mg)
SA	=	Surface area available for contact (cm ² /day)
AF	=	Adherence factor (1.0 mg/cm ²)
ABS	=	Absorption factor (dimensionless) - 0.01 organics, 0.001 inorganics (USEPA, Region IV, 1992d)
EF	=	Exposure frequency (days/year)
ED	=	Exposure duration (years)

BW = Body weight (kg)
AT = Averaging time (days)

The following paragraphs discuss the exposure assumptions used in the estimation of exposure to COPCs from dermal contact with sediment.

Current Trespassers and Future Residents

Future on-site residents and current trespassers could also be potentially exposed to COPCs in sediment via dermal contact while wading. As in the surface water exposure scenario, the total body surface area was 5,800 cm² for adult residents and 2,300 cm² for child residents. Also, the SA values for the adult and child trespassers were assumed to be 5,000 cm² and 2,000 cm², respectively. Exposure duration, exposure frequencies, body weights, and averaging times were the same as those discussed for the surface water exposure scenario presented previously. The values for AF and ABS were provided with the equation and are in accordance with USEPA and Region IV guidance. Table 6-8 provides a complete summary of the input parameters used in the estimation of CDIs for this scenario.

6.4 Toxicity Assessment

The purpose of this section is to define the toxicological values used to evaluate the exposure to the COPCs identified in Section 6.2. A toxicological evaluation characterizes the inherent toxicity of a compound. It consists of the review of scientific data to determine the nature and extent of the potential human health and environmental effects associated with exposure to various contaminants.

Human data from occupational exposures are often insufficient for determining quantitative indices of toxicity because of uncertainties in exposure estimates and inherent difficulties in determining causal relationships established by epidemiological studies. For this reason, animal bioassays are conducted under controlled conditions and their results are extrapolated to humans. There are several stages to this extrapolation. First, to account for species differences, conversion factors are used to extrapolate from test animals to humans. Second, the relatively high doses administered to test animals must be extrapolated to the lower doses more typical of human exposures. For potential noncarcinogens, safety factors and modifying factors are applied to animal results when developing acceptable human doses. For potential carcinogens, mathematical models are used to extrapolate effects at high doses to effects at lower doses. Epidemiological data can be used for inferential purposes to establish the credibility of the experimentally derived indices.

The available toxicological information indicates that many of the COPCs have both potential carcinogenic and noncarcinogenic health effects in humans and/or experimental animals. Although the COPCs may cause adverse health and environmental impacts, dose-response relationships and the potential for exposure must be evaluated before the risk to receptors can be determined. Dose-response relationships correlate the magnitude of the dose with the probability of toxic effects, as discussed in the following section.

An important component of the risk assessment is the relationship between the dose of a compound (amount to which an individual or population is potentially exposed) and the potential for adverse health effects resulting from the exposure to that dose. Dose-response relationships provide a means by which potential public health impacts may be evaluated. The published information on doses and

responses is used in conjunction with information on the nature and magnitude of exposure to develop an estimate of risk.

Standard carcinogenic slope factors (CSFs) and/or reference doses (RfDs) have been developed for many of the COPCs. This section provides a brief description of these parameters.

6.4.1 Carcinogenic Slope Factor

CSFs are used to estimate an upper-bound lifetime probability of an individual developing cancer as a result of exposure to a particular level of a potential carcinogen (USEPA, 1989). This factor is generally reported in units of (mg/kg/day)⁻¹ and is derived through an assumed low-dosage linear multistage model and an extrapolation from high to low dose-responses determined from animal studies. The value used in reporting the slope factor is the upper 95th percent confidence limit.

These slope factors are also accompanied by USEPA weight-of-evidence (WOE) classifications, which designate the strength of the evidence that the COPC is a potential human carcinogen.

In assessing the carcinogenic potential of a chemical, the Human Health Assessment Group (HHAG) of USEPA classifies the chemical into one of the following groups, according to the weight of evidence from epidemiologic and animal studies:

- Group A - Human Carcinogen** (sufficient evidence of carcinogenicity in humans)
- Group B - Probable Human Carcinogen** (B1 - limited evidence of carcinogenicity in humans; B2 - sufficient evidence of carcinogenicity in animals with inadequate or lack of evidence in humans)
- Group C - Possible Human Carcinogen** (limited evidence of carcinogenicity in animals and inadequate or lack of human data)
- Group D - Not Classifiable as to Human Carcinogenicity** (inadequate or no evidence)
- Group E - Evidence of Noncarcinogenicity for Humans** (no evidence of carcinogenicity in adequate studies)

6.4.2 Reference Dose

The RfD is developed for chronic and/or subchronic human exposure to chemicals and is based solely on the noncarcinogenic effects of chemical substances. It is defined as an estimate of a daily exposure level for the human population, including sensitive populations, that is not likely to cause an appreciable risk of adverse effects during a lifetime. The RfD is usually expressed as dose (mg) per unit body weight (kg) per unit time (day). It is generally derived by dividing a no-observed-(adverse)-effect-level (NOAEL or NOEL) or a lowest observed-adverse-effect-level (LOAEL) for the critical toxic effect by an appropriate uncertainty factor (UF). Effect levels are determined from laboratory or epidemiological studies. The UF is based on the availability of toxicity data.

UFs usually consist of multiples of 10, where each factor represents a specific area of uncertainty naturally present in the extrapolation process. These UFs are presented below and were taken from the Risk Assessment Guidance Document for Superfund, Volume I, Human Health Evaluation Manual (Part A) (USEPA, 1989):

- A UF of 10 is to account for variation in the general population and is intended to protect sensitive populations (e.g., elderly, children).
- A UF of 10 is used when extrapolating from animals to humans. This factor is intended to account for the interspecies variability between humans and other mammals.
- A UF of 10 is used when a NOAEL derived from a subchronic instead of a chronic study is used as the basis for a chronic RfD.
- A UF of 10 is used when a LOAEL is used instead of a NOAEL. This factor is intended to account for the uncertainty associated with extrapolating from LOAELs to NOAELs.

In addition to UFs, a modifying factor (MF) is applied to each reference dose and is defined as:

- A MF ranging from >0 to 10 is included to reflect a qualitative professional assessment of additional uncertainties in the critical study and in the entire data base for the chemical not explicitly addressed by the preceding uncertainty factors. The default for the MF is 1.

Thus, the RfD incorporates the uncertainty of the evidence for chronic human health effects. Even if applicable human data exist, the RfD still maintains a margin of safety so that chronic human health effects are not underestimated.

Toxicity factors and the USEPA WOE classifications are presented in Table 6-10. The hierarchy (USEPA, 1989) for choosing these values was as follows:

- Integrated Risk Information System (IRIS, 1995)
- Health Effects Assessment Summary Table (HEAST, 1995)

The IRIS data base is updated monthly and contains both verified CSFs and RfDs. The USEPA has formed the Carcinogen Risk Assessment Verification Endeavor (CRAVE) Workgroup to review and validate toxicity values used in developing CSFs. Once the slope factors have been verified via extensive peer review, they appear in the IRIS data base. Like the CSF Workgroup, the USEPA has formed a RfD Workgroup to review existing data used to derive RfDs. Once the reference doses has been verified, they also appear in IRIS.

HEAST on the other hand, provides both interim (unverified) and verified CSFs and RfDs. This document is published quarterly and incorporates any applicable changes to its data base.

Toxicity values will be obtained primarily from the Region III Risk-Based Concentration Table, which is based on IRIS, HEAST and provisional and/or recommended USEPA toxicity values, in accordance with Region IV recommendations.

For some chemicals, there are no USEPA-verified toxicity values (i.e., RfDs and CSFs) available for risk quantitation. This is the case for lead. The following section provides a discussion of how lead health effects were quantified for this assessment.

For other chemicals, the toxicity values of similarly structured compounds were substituted. For this site, the chemical substitutes were as follows: naphthalene for 2-methylnaphthalene, pyrene for benzo(g,h,i)perylene and phenanthrene, and chlordane for alpha-chlordane and gamma-chlordane. In addition, there are some chemicals with different toxicity values associated with the medium in which they are detected. For example, the oral RfD for cadmium differs when found in food or water. Consequently, the oral RfD associated with food was applied for assessing soil exposure, and the oral RfD associated with water was used accordingly.

6.4.3 Lead

Lead was identified as a COPC in the surface water and sediment at Site 44. Currently, health-based criteria are not available for evaluating either the noncarcinogenic or carcinogenic effects of lead exposure. The USEPA has not developed health-based criteria because a threshold level for many noncancer health effects has not been identified in infants and younger children (i.e., the most sensitive populations). Consequently, risk from lead in surface water and sediment was not calculated for the site.

6.4.4 Dermal Adjustment of Toxicity Factors

Because there are few toxicity reference values for dermal exposure, oral values are frequently used to assess risk from dermal exposure. Most RfDs and some slope factors are expressed as the amount of substance administered per unit time and unit body weight, while exposure estimates for the dermal route are expressed as absorbed dose. Consequently, it may be necessary to adjust an oral toxicity value from an administered dose to an absorbed dose.

Region IV provides absorption efficiency values for each class of chemicals. They are as follows:

VOCs	=	0.80
SVOCs	=	0.50
Inorganics	=	0.20
Pesticides/PCBs	=	0.50

An adjusted oral RfD is the product of the absorption efficiency and the oral toxicity reference value. The adjusted oral CSF is the ratio of the oral toxicity value and the absorption efficiency. Table 7-11 presents a summary of the dermally-adjusted toxicity values used in this BRA.

6.5 Risk Characterization

This section presents and discusses the estimated incremental lifetime cancer risks (ICRs) and hazard indices (HIs) for identified potential receptor groups which could be exposed to COPCs via the exposure pathways presented in Section 6.3.

These quantitative risk calculations for potentially carcinogenic compounds estimate ICRs levels for an individual in a specified population. This unit risk refers to the cancer risk that is over and above the background cancer risk in unexposed individuals. For example, an ICR of 1×10^{-6} indicates that, for a lifetime exposure, one additional case of cancer may occur per one million exposed individuals.

The ICR to individuals was estimated from the following relationship:

$$ICR = \sum_{i=1}^n CDI_i \times CSF_i$$

where CDI_i is the chronic daily intake (mg/kg/day) for compound i and CSF_i is the cancer slope in (mg/kg/day)⁻¹ for contaminant i . The CSF is defined in most instances as an upper 95th percentile confidence limit of the probability of a carcinogenic response based on experimental animal data, and the CDI is defined as the exposure expressed as a mass of a substance contracted per unit body weight per unit time, averaged over a period of time (i.e., six years to a lifetime). The above equation was derived assuming that cancer is a non-threshold process and that the potential excess risk level is proportional to the cumulative intake over a lifetime.

In contrast to the above approach for potentially carcinogenic effects, quantitative risk calculations for noncarcinogenic compounds assume that a threshold toxicological effect exists. Therefore, the potential for noncarcinogenic effects is calculated by comparing CDIs with threshold levels (reference doses).

Noncarcinogenic effects were estimated by calculating the hazard index (HI) which is defined as:

$$HI = HQ_1 + HQ_2 + \dots + HQ_n \text{ or}$$

$$HI = \sum_{i=1}^n HQ_i$$

$$\text{where } HQ_i = CDI_i / RfD_i$$

HQ_i is the hazard quotient for contaminant i , CDI_i is the chronic daily intake (mg/kg/day) of contaminant i , and RfD_i is the reference dose (mg/kg/day) of the contaminant i over a prolonged period of exposure.

6.5.1 Human Health Risks

The following paragraphs present the quantitative results of the human health evaluation for each medium and area of concern at Site 44.

Estimated ICRs were compared to the target risk range of 1×10^{-6} to 1×10^{-4} . A value of 1.0 was used for examination of the HI. The HI was calculated by comparing estimated CDIs with threshold levels below which, noncarcinogenic health effects are not expected to occur. Any HI equal to or exceeding 1.0 suggested that noncarcinogenic health effects were possible. If the HI was less than 1.0, then systemic human health effects were considered unlikely. Tables 6-12 through 6-17 present these risk results.

6.5.1.1 Current Military Personnel

The current military receptor was evaluated for potential noncarcinogenic and carcinogenic risk from exposure to the surface soil. The noncarcinogenic (i.e., $HI=0.08$) and carcinogenic risks

(i.e., $ICR=3.5 \times 10^{-7}$) fell below the acceptable risk levels (i.e., $HI < 1$ and $1 \times 10^{-6} < ICR < 1 \times 10^{-4}$). These results are presented in Table 6-12.

6.5.1.2 Current Trespasser Child

In the current scenario, a recreational child receptor was evaluated for potential risk from exposure to site surface soils and surface water and sediment from Edwards Creek and the unnamed tributary. The potential noncarcinogenic and carcinogenic risks from exposure to the surface soil (i.e., $HI=0.18$ and $ICR=1.2 \times 10^{-6}$), the surface water (i.e., $HI=0.02$ and $ICR=1.9 \times 10^{-6}$), and sediment (i.e., $HI=0.05$ and $ICR=7.7 \times 10^{-7}$) were within acceptable risk levels (i.e., $HI < 1$ and $1 \times 10^{-6} < ICR < 1 \times 10^{-4}$). These results are presented in Table 6-13.

6.5.1.3 Future Residential Child

The child receptor was evaluated for potential risk from exposure to surface soil and groundwater in the future scenario. It was assumed that current exposure to surface water and sediment also would occur in the future case.

The potential noncarcinogenic and carcinogenic risks from exposure to the surface soil (i.e., $HI=0.95$ and $ICR=6.0 \times 10^{-6}$), the surface water (i.e., $HI=0.02$ and $ICR=2.1 \times 10^{-6}$) and sediment (i.e., $HI=0.05$ and $ICR=7.8 \times 10^{-7}$) were within acceptable risk levels (i.e., $HI < 1$ and $1 \times 10^{-6} < ICR < 1 \times 10^{-4}$). The results are summarized in Table 6-14.

In groundwater, there is a potential noncarcinogenic risk from ingestion for the child receptor. The total noncarcinogenic risk level of 17 was due primarily to groundwater ingestion ($HQ=16$). This value exceeded the acceptable risk level of one for noncarcinogenic risks. Primarily, iron in groundwater contributed to this risk.

The total carcinogenic risk of 1.0×10^{-4} exceeds USEPA's generally acceptable carcinogenic risk range. This risk level was due primarily to the presence of vinyl chloride in groundwater. It should be noted that no individual exposure pathway (i.e., ingestion, dermal contact, or inhalation) produced a carcinogenic risk exceeding USEPA's acceptable risk range. The risk results are presented in Table 6-14.

6.5.1.4 Current Trespasser Adult

In the current scenario, an adult trespasser was evaluated for potential risk from exposure to site surface soils (i.e., $HI=0.01$ and $ICR=2.8 \times 10^{-7}$) and surface water (i.e., $HI=0.01$ and $ICR=4.4 \times 10^{-6}$), and sediment (i.e., $HI=0.01$ and $ICR=6.0 \times 10^{-7}$). The potential noncarcinogenic and carcinogenic risks from exposure to these media were within acceptable risk levels (i.e., $HI < 1$ and $1 \times 10^{-6} < ICR < 1 \times 10^{-4}$). These results are provided in Table 6-15.

6.5.1.5 Future Residential Adult

The adult receptor was evaluated for potential risk from exposure to surface soil and groundwater in the future scenario. Similar to the child receptor, it was assumed that current exposure to the surface water and sediment also would occur in the future case.

In surface soil (i.e., HI=0.12 and ICR=3.9x10⁻⁶), surface water (i.e., HI=0.01 and ICR=5.0x10⁻⁶), and sediment (i.e., HI=0.01 and ICR=6.5x10⁻⁷), the potential noncarcinogenic and carcinogenic risks from exposure to these media were within acceptable levels (i.e., HI<1 and 1x10⁻⁶<ICR<1x10⁻⁴). Table 6-16 summarizes these results.

In groundwater, there is a potential noncarcinogenic risk from ingestion for the adult receptor. The total noncarcinogenic risk level of 7.0 was due primarily to groundwater ingestion. This value exceeded the acceptable risk level of one for noncarcinogenic risks. Iron in groundwater contributed to this risk.

The total carcinogenic risk of 2.0x10⁻⁴ exceeds USEPA's generally acceptable carcinogenic risk range. This risk level was due primarily to the presence of vinyl chloride in groundwater. It should be noted that approximately 86% of the risk comes from the groundwater ingestion exposure pathway (HQ=1.8x10⁻⁴). The risk results are presented in Table 6-16.

6.5.1.6 Construction Worker

The construction worker was evaluated for potential noncarcinogenic and carcinogenic risk from exposure to subsurface soil in the future case. The carcinogenic risk (i.e. HI=0.07 and ICR=6.6x10⁻⁸) from exposure to the subsurface soil fell within the acceptable risk range of 1x10⁻⁶<ICR<1x10⁻⁴. Table 6-17 presents these results.

6.6 Sources of Uncertainty

Uncertainties may be encountered throughout the BRA process. This section discusses the sources of uncertainty involved with the following:

- Analytical data
- Exposure Assessment
- Toxicity Assessment
- Compounds Not Qualitatively Evaluated

In addition, the USEPA stresses the importance of recognizing the unique characteristics and circumstances of each facility and the need to formulate site-specific responses. However, many of the assumptions presented in this document were derived from USEPA guidance, which is designed to provide a conservative approach and cover a broad variety of cases. As such, the generic application of such assumptions to a site in the RME case scenario may work against the objective of formulating a site-specific response to a constituent presence (i.e., it is possible that the site risks may be overestimated).

The following sections provide a discussion of the sources of uncertainty associated with this BRA and the effects on total site risk.

6.6.1 Analytical Data

The development of a BRA depends on the reliability of and uncertainties with the analytical data available to the risk assessor. Analytical data are limited by the precision and accuracy of the analytical method of analysis. In addition, the statistical methods used to compile and analyze the

data (mean concentration, standard deviation, and detection frequencies) are subject to the uncertainty in the ability to acquire data.

Data validation serves to reduce some of the inherent uncertainty associated with the analytical data by establishing the usability of the data to the risk assessor who may or may not choose to include the data point in the estimation of risk. Data qualified as "J" (estimated) were retained for the estimation of risk at OU No. 6. Data can be qualified as estimated for many reasons including a slight exceedance of holding times, high or low surrogate recovery, or intra sample variability. Organic data qualified "B" (detected in blank) or "R" (unreliable) were not used in the estimation of risk due to the unusable nature of the data. Due to the comprehensive sampling and analytical program at OU No. 6, the loss of some data points qualified "B" or "R" did not significantly increase the uncertainty in the estimation of risk.

6.6.2 Exposure Assessment

In performing exposure assessments, uncertainties can arise from two main sources. First, the chemical concentration to which a receptor may be exposed must be estimated for every medium of interest. Second, uncertainties can arise in the estimation of contaminant intakes resulting from contact by a receptor with a particular medium.

Estimating the contaminant concentration in a given medium to which a human receptor could potentially be exposed can be as simple as deriving the 95th percent upper confidence limit of the mean for a data set. More complex methods of deriving the contaminant concentration are necessary when exposure to COPCs in a given medium occurs subsequent to release from another medium, or when analytical data are not available to characterize the release. In this case, modeling is usually employed to estimate the potential human exposure.

The potential inhalation of fugitive dusts from affected soils was estimated in the BRA using USEPA's Rapid Assessment of Exposure to Particulate Emissions from Surface Contaminated Sites (Cowherd et al. 1985). The Cowherd model employs the use of a default PEF for wind erosion based on source area and vegetative cover. A conservative estimate of the PEF was used for Site 44 by assuming 0.5 acre source area with 50% erosion potential (USEPA, 1995c). Modeling results for fugitive dust emission exposure suggested that the potential risk associated with this pathway was not significant.

Groundwater samples were analyzed for total (unfiltered) and dissolved (filtered) inorganic contaminants. These samples were obtained from wells which were constructed using USEPA Region IV monitoring well design specifications. Groundwater taken from monitoring wells cannot be considered representative of potable groundwater or groundwater which is obtained from a domestic well "at the tap". The use of total inorganic analytical results overestimates the potential human health risks associated with potable use scenarios. However, for the sake of conservatism, total organic results were used to estimate the potential intake associated with groundwater use.

Currently, the shallow groundwater is not used as a potable source. Current receptors (military personnel, military dependents, and civilian base personnel) are exposed via ingestion, dermal contact, and inhalation to groundwater drawn from the deep zone. Therefore, assessing current risks to contaminants detected in the shallow aquifer for current receptors is unnecessary and, if estimated, may present an unlikely risk. Therefore, groundwater exposure to current receptors was not estimated for this investigation.

As stated previously, both the shallow and deep groundwater analytical results were combined and evaluated as single data set for the risk evaluation. It is important to note that the shallow groundwater is not currently used for potable purposes at the site. In addition, it is highly unlikely that this groundwater will be used similarly in the future. However, because it was determined (see Section 2.0 of this report) that the shallow and deep groundwater systems are interconnected, the data were combined and evaluated as a single set for the risk assessment. Use of this combined data set lends a certain degree of uncertainty to the risks calculated for groundwater exposure.

To estimate an intake, certain assumptions must be made about exposure events, exposure durations, and the corresponding assimilation of contaminants by the receptor. Exposure factors, have been generated by the scientific community and have undergone review by the USEPA. Regardless of the validity of these exposure factors, they have been derived from a range of values generated by studies of limited number of individuals. In all instances, values used in the risk assessment, scientific judgments, and conservative assumptions agree with those of the USEPA. Conservative assumptions designed not to underestimate daily intakes were employed throughout the BRA and should error conservatively, thus adequately protecting human health and allowing the establishment of reasonable clean-up goals.

6.6.3 Sampling Strategy

Soil represents a medium of direct contact exposure and often is the main source of contaminants released into other media. The soil sampling depth should be applicable for the exposure pathways and contaminant transport routes of concern and should be chosen purposely within that depth interval. If a depth interval is chosen purposely, a random sample procedure to select a sampling point may be established. The assessment of surface exposure at the site is certain based on collection of samples from the shallowest depth, zero to one foot. Subsurface soil samples are important, however, if soil disturbance is likely or leaching of chemicals to groundwater is of concern.

In the future exposure scenarios, subsurface soil exposure was evaluated. It was assumed that the subsurface soil would be excavated and used as surface grading, landscaping, etc., in the foreseeable future. It is important to note that many of these subsurface soil samples were collected at depths ranging from 1 foot to possibly up to 90 feet, depending on the depth of the well from which the soil boring was collected. It is may be unrealistic to assume that excavation could occur at such depths. It follows that exposure to contaminants in soil at these depths would be unlikely for future receptors. However, for the BRA, the subsurface soil analytical results were not segregated by depth, but were evaluated as a single data set. Consequently, levels found at all depths were evaluated for potential risk to human health. The use of the entire subsurface soil data set may add to the conservative nature of the approach used to assess risk for this site.

The surface soil samples at all sites were obtained directly or very near the suspected disposal areas. Therefore, these areas would be considered areas of very high concentration which would have a significant impact on exposures.

6.6.4 Toxicity Assessment

In making quantitative estimates of the toxicity of varying doses of a compound to human receptors, uncertainties arise from two sources. First, data on human exposure and the subsequent effects are usually insufficient, if they are available at all. Human exposure data usually lack adequate

concentration estimations and suffer from inherent temporal variability. Therefore, animal studies are often used; and, therefore, new uncertainties arise from the process of extrapolating animal results to humans. Second, to obtain observable effects with a manageable number of experimental animals, high doses of a compound are used over a relatively short time period. In this situation, a high dose means that experimental animal exposures are much greater than human environmental exposures. Therefore, when applying the results of the animal experiment to humans, the effects at the high doses must be extrapolated to approximate effects at lower doses.

In extrapolating effects from animals to humans and high doses to low doses, scientific judgment and conservative assumptions are employed. In selecting animal studies for use in dose-response calculations, the following factors are considered:

- Studies are preferred where the animal closely mimics human pharmacokinetics
- Studies are preferred where dose intake most closely mimics the intake route and duration for humans
- Studies are preferred which demonstrate the most sensitive response to the compound in question

For compounds believed to cause threshold effects (i.e., noncarcinogens), safety factors are employed in the extrapolation of effects from animals to humans and from high to low doses.

Conservatism is also introduced through the use of experimentally-derived oral absorption efficiencies to adjust oral toxicity criteria (i.e., CSFs and RfDs), derived during studies based on administered dosages, for the estimation of dermal absorption. Equating the absorption efficiency of the bi-phasic dermal barrier to that of the mono-phasic gastrointestinal lining and then applying it to oral toxicity criteria in a dermal risk assessment scenario tends to generally overestimate the potential risk to human health by no more than an order of magnitude.

The use of conservative assumptions results in quantitative indices of toxicity that are not expected to underestimate potential toxic effects, but may overestimate these effects by an order of magnitude or more.

6.7 Conclusions of the BRA for Site 44

The BRA highlights the media of interest from the human health standpoint at Site 44 by identifying areas with risk values greater than acceptable levels. Current and future potential receptors at the site included current military personnel, current trespassers (i.e., children and adults), future residents (i.e., children and adults), and future construction workers. The total risk from the site for these receptors was estimated by logically summing the multiple pathways likely to affect the receptor during a given activity. Exposure to surface soil, surface water and sediment was assessed for the current receptors. Surface soil, groundwater, surface water, and sediment exposure were evaluated for the future residents. Subsurface soil exposure was evaluated for the future construction worker.

6.7.1 Current Scenario

In the current case, the following receptors were assessed: military personnel and adult and child trespassers. Receptor exposure to surface soil, surface water, and sediment at Site 44 was examined. The risks calculated for all exposure pathways and receptors were within acceptable risk ranges.

6.7.2 Future Scenario

In the future case, child and adult residents were assessed for potential exposure to groundwater, surface soil, surface water, and sediment. A construction worker was evaluated for subsurface soil exposure. The potential noncarcinogenic and carcinogenic risks for the construction worker at Site 44 were within acceptable levels. The carcinogenic risk for the future child resident was 1.0×10^{-4} . The carcinogenic risk for the future adult resident was 2.0×10^{-4} . Both ICR values are driven by the presence of vinyl chloride in groundwater. Table 6-12 and Table 6-14 present these values.

It should be noted that vinyl chloride was detected in one of nine samples from well location 44-TW01-01. This well is located approximately 50 feet from the Edwards Creek. Due to the location of the well, the presence of vinyl chloride appears to be related to creek contaminants rather than migration of groundwater contaminants. In addition, VOCs were not detected in surface soil, subsurface soil, and other groundwater samples at Site 44 (see Section 5.0 for further discussion).

The noncarcinogenic risk from groundwater ingestion for the future child resident was 16. The noncarcinogenic risk from groundwater ingestion for the future adult resident was 7.1. This value exceeds the acceptable risk value of one. The iron detected in the groundwater is driving this risk. Table 6-14 and Table 6-16 present these values.

Iron constitutes 98% of both elevated risk values. Without iron as a COPC, the noncarcinogenic risk values for future residential adults and children would be 0.15 and 0.35, respectively. The studies that prompted the addition of a RBC value for iron are provisional only and have not undergone formal review by the USEPA. Also, iron is considered an essential nutrient.

Finally, it should be noted that groundwater in the MCB Camp Lejeune area is naturally rich in iron. In addition, there is no record of any historical use of iron at Site 44. Consequently, it is assumed that iron is a naturally occurring inorganic analyte in groundwater, and its presence is not attributable to site operations. Tables 6-14 and Table 6-16 present these values.

6.8 References

Cowherd, 1985. Cowherd, C., et al. Rapid Assessment of Exposure to Particulate Emissions from Surface Contamination. Prepared for EPA Office of Health and Environmental Assessment. EPA/600/8-85/002.

Foster, 1986. Foster, S.A. and P.C. Chrostowaski. "Integrated Household Exposure Model for Use of Tap Water Contaminated with Volatile Organic Chemicals." Presented at the 79th Annual Meeting of the Air Pollution Control Association, Minneapolis, Minnesota. June 22-27, 1986.

USEPA, 1989. U.S. Environmental Protection Agency. Risk Assessment Guidance for Superfund Volume I. Human Health Evaluation Manual (Part A) Interim Final. Office of Solid Waste and Emergency Response. Washington, D.C. EPA/540/1-89-002. December 1989.

USEPA, 1989a. U.S. Environmental Protection Agency. Exposure Factors Handbook. July 1989.

USEPA, 1990. U.S. Protection Agency. National Oil and Hazardous Substances Pollution Contingency Plan. 55FR8665. Office of Emergency and Remedial Response. Washington, D.C. March 1990.

USEPA, 1991. U.S. Environmental Protection Agency. Risk Assessment Guidance for Superfund Volume I. Human Health Evaluation Manual Supplemental Guidance. "Standard Default Exposure Factors" Interim Final. Office of Solid Waste and Emergency Response. Washington, D.C. OSWER Directive 9285.6-03. March 25, 1991.

USEPA, 1991a. U.S. Environmental Protection Agency. June 1991. National Functional Guidelines for Organic Data Review. Draft. USEPA Contract Laboratory Program.

USEPA, 1992. U.S. Environmental Protection Agency. Dermal Exposure Assessment: Principles and Applications. Interim Report. Office of Health and Environmental Assessment. Washington, D.C. EPA/600/8-91/011B. January 1992.

USEPA, 1992a. U.S. Environmental Protection Agency. New Interim Region IV Guidance for Toxicity Equivalency Factor (TEF) Methodology. Region IV Water Management Division.

USEPA, 1992b. U.S. Environmental Protection Agency. Supplemental Guidance to RAGS: Calculating the Concentration Term. Office of Solid Waste and Emergency Response. Washington, D.C., Publication 9285.7-081. May 1992.

USEPA, 1992c. U.S. Environmental Protection Agency. Region IV Waste Management Division Screening Values for Hazardous Waste Sites. Region IV, Atlanta Georgia. January 1992.

USEPA, 1992d. USEPA Region IV Supplemental Risk Guidance. February 11, 1992.

USEPA, 1993. U.S. Environmental Protection Agency. Region IV Waste Management Division Screening Values for Hazardous Waste Sites. Region IV, Atlanta, Georgia. January 1993.

USEPA. 1995. U.S. Environmental Protection Agency. Health Effects Assessment Summary Tables Annual FY-1995. Office of Solid Waste and Emergency Response. Washington, D.C. EPA/540/R-95/036 PB95-921199. May 1995.

USEPA, 1995a. U.S. Environmental Protection Agency. Integrated Risk Information System (IRIS). Environmental Criteria and Assessment Office, Cincinnati, Ohio.

USEPA, 1995b. U.S. Environmental Protection Agency. Region III Risk-Based Concentration Table. Philadelphia, Pennsylvania. October, 1995.

USEPA, 1995c. U. S. Environmental Protection Agency. Phone conversation with Janine Dinan. Washington, D.C. November 17, 1995.

USEPA, 1995d. U. S. Environmental Protection Agency. Region IV Supplemental Guidance to RAGS. Human Health Risk Assessment Bulletin No. 3. Region IV, Atlanta, Georgia. November, 1995.

Water and Air Research, Inc. (WAR). 1983. Initial Assessment Study of Marine Corps Base Camp Lejeune, North Carolina. Prepared for Naval Energy and Environmental Support Activity.

SECTION 6.0 TABLES

TABLE 6-1

CONTAMINANTS OF POTENTIAL CONCERN
 ORGANICS IN SURFACE SOIL
 SITE 44-JONES STREET DUMP
 REMEDIAL INVESTIGATION, CTO-0303
 MCB, CAMP LEJEUNE, NORTH CAROLINA

Contaminant	Minimum Value (µg/kg)	Maximum Value (µg/kg)	95% UCL of Lognormal Distribution (µg/kg)	Location of Maximum Detected Value	Frequency of Detection	Frequency Percentage (%)	Region III Residential Soil Screening Value (µg/kg)	Screening Value Exceedance Frequency
Volatiles: Acetone	13J	13J	8.67	44-WA-SBO4-00	1/13	8%	780,000	0/13
Semivolatiles: Bis(2-chloroethyl)ether	550J	550J	264.44	44-OA-SB06-00	1/13	8%	580	0/13
2,6-Dinitrotoluene	380J	380J	237.55	44-OA-SB02-00	1/13	8%	7,800	0/13
Bis(2-ethylhexyl)phthalate	260J	260J	215.74	44-OA-SB02-00	1/13	8%	46,000	0/13
Indeno(1,2,3-cd)pyrene	220J	220J	208.55	44-OA-SB05-00	1/13	8%	880	0/13
Benzo(g,h,i)perylene ⁽¹⁾	57J	200J	238.60	44-OA-SB05-00	2/13	15%	230,000	0/13
Pesticides: 4,4'-DDE	10J	140	155.08	44-OA-SB05-00	4/13	31%	1,900	0/13
4,4'-DDD	7.4J	7.4J	2.93	44-OA-SB03-00	1/13	8%	2,700	0/13
4,4'-DDT	4.6J	45J	22.97	44-OA-SB03-00	4/13	31%	1,900	0/13

Notes:

COPCs are indicated by the shaded areas.

⁽¹⁾ USEPA Region III COC screening value for pyrene used as a surrogate.

TABLE 6-2

CONTAMINANTS OF POTENTIAL CONCERN
 INORGANICS IN SURFACE SOIL
 SITE 44-JONES STREET DUMP
 REMEDIAL INVESTIGATION, CTO-0303
 MCB, CAMP LEJEUNE, NORTH CAROLINA

Parameter	Minimum Value (mg/kg)	Maximum Value (mg/kg)	95% UCL of Lognormal Distribution (mg/kg)	Location of Maximum Detected Value	Frequency of Detection	Frequency Percentage (%)	2X Base Background (mg/kg)	Region III Residential Soil Screening Value (mg/kg)	Screening Value Exceedance Frequency
Aluminum	3520	14,100	11,112.40	44-GW05-00	13/13	100%	5,940.59	7,800	7/13
Arsenic	0.79J	4.9J	3.45	44-WA-SB02-00	13/13	100%	1.31	0.43	13/13
Barium	8.3	26.2	21.26	44-OA-SB03-00	13/13	100%	17.36	550	0/13
Calcium	111	5,800J	11530.61	44-OA-SB01-00	13/13	100%	1,396.79	--	NA
Chromium	4.2	16.4	16.49	44-OA-SB01-00	12/13	92%	6.69	39	0/13
Cobalt	0.57	1.3	0.78	44-OA-SB01-00	5/13	38%	1.92	470	0/13
Copper	0.86	910	191.27	44-OA-SB03-00	12/13	92%	7.20	310	1/13
Iron	2,430J	15,400	12,930.25	44-GW01DW-00	13/13	100%	3,755.06	2,300	13/13
Lead	5.9	31.7J	16.98	44-OA-SB03-00	11/13	85%	23.75	400	0/13
Magnesium	115	546	411.42	44-OA-SB01-00	13/13	100%	205.75	--	NA
Manganese	4.9	44.2	17.38	44-OA-SB03-00	13/13	100%	18.50	1,100 ⁽¹⁾	0/13
Nickel	0.97	2.8	1.83	44-OA-SB03-00	10/13	77%	3.43	160	0/13
Potassium	109	339	302.03	44-OA-SB01-00	12/13	92%	199.61	--	NA
Selenium	0.31J	0.72	0.39	44-GW05-00	5/13	38%	0.75	39	0/13
Sodium	16.6	57.1	53.03	44-WA-SB04-00	9/13	69%	59.30	--	NA
Vanadium	7	28.6	24.30	44-GW04-00	13/13	100%	11.63	55	0/13
Zinc	2.7	156	33.14	44-OA-SB03-00	13/13	100%	13.88	2,300	0/13

Notes:

COPCs are indicated by the shaded areas.

⁽¹⁾ Screening value based on a RfD of 0.14 mg/kg/day.

TABLE 6-3

CONTAMINANTS OF POTENTIAL CONCERN
 ORGANICS IN SUBSURFACE SOIL
 SITE 44-JONES STREET DUMP
 REMEDIAL INVESTIGATION, CTO-0303
 MCB, CAMP LEJEUNE, NORTH CAROLINA

Contaminant	Minimum Value (µg/kg)	Maximum Value (µg/kg)	95% UCL of Lognormal Distribution (µg/kg)	Location of Maximum Detected Value	Frequency of Detection	Frequency Percentage (%)	Region III Residential Soil Screening Value (µg/kg)	Screening Value Exceedance Frequency
Volatiles: Acetone	61	61	41.53	44-OA-SB01-04	1/12	8%	780,000	0/12
Semivolatiles: Bis(2-ethylhexyl)phthalate	83J	83J	214.93	44-OA-SB02-03	1/13	8%	46,000	0/13
Indeno(1,2,3-cd)pyrene	55J	130J	227.91	44-OA-SB05-02	2/13	15%	880	0/13
Benzo(g,h,i)perylene ⁽¹⁾	40J	120J	247.64	44-OA-SB05-02	3/13	23%	230,000	0/13
Pesticides: 4,4'-DDE	3.2J	370J	46.15	44-GW01DW-03	4/13	31%	1,900	0/13
4,4'-DDD	5.6	2,500	1183.84	44-GW01DW-03	4/13	31%	2,700	0/13
4,4'-DDT	150J	150J	17.75	44-GW01DW-03	1/13	8%	1,900	0/13

Notes:

COPCs are indicated by the shaded areas.

⁽¹⁾ USEPA Region III COC screening value for pyrene used as a surrogate.

TABLE 6-4

**CONTAMINANTS OF POTENTIAL CONCERN
INORGANICS IN SUBSURFACE SOIL
SITE 44-JONES STREET DUMP
REMEDIAL INVESTIGATION, CTO-0303
MCB, CAMP LEJEUNE, NORTH CAROLINA**

Parameter	Minimum Value (mg/kg)	Maximum Value (mg/kg)	95% UCL of Lognormal Distribution (mg/kg)	Location of Maximum Detected Value	Frequency of Detection	Frequency Percentage (%)	2X Base Background (mg/kg)	Region III Residential Soil Screening Value (mg/kg)	Screening Value Exceedance Frequency
Aluminum	1,520	9,940	7,678.15	44-OA-SB02-03	13/13	100%	7,375.30	7,800	1/13
Arsenic	0.31J	2.5	1.73	44-WA-SB04-03	10/13	77%	1.97	0.43	9/13
Barium	3.4	13.7	14.68	44-WA-SB02-03	12/13	92%	14.20	550	0/13
Calcium	15.6	3,880	4,760.48	44-GW01DW-03	13/13	100%	391.51	--	NA
Chromium	2.1	9.5	8.99	44-WA-SB03-03	13/13	100%	12.56	39	0/13
Copper	0.42	2.9	1.20	44-GW01DW-03	9/13	69%	2.42	290	0/13
Iron	389	8,270	6,991.68	44-GW01DW-03	13/13	100%	7,252.08	2,300	9/13
Lead	1.4	9.1	7.45	44-GW01DW-03	11/13	85%	8.33	400	0/13
Magnesium	43.2	254	249.78	44-OA-SB01-04	13/13	100%	260.72	--	NA
Manganese	1.3	9.3	8.29	44-WA-SB02-03	13/13	100%	7.92	1,100 ⁽¹⁾	0/13
Nickel	1.3	15.8	7.17	44-GW01DW-03	6/13	46%	3.71	160	0/13
Potassium	53	261	214.33	44-OA-SB01-04	11/13	85%	347.24	--	NA
Sodium	3.9	32	27.41	44-OA-SB06-02	6/13	46%	52.68	--	NA
Vanadium	3.2	19.2	13.29	44-GW01DW-03	13/13	100%	13.45	55	0/13
Zinc	0.76	10.8	4.89	44-WA-SB04-03	12/13	100%	6.66	2,300	0/13

Notes:

COPCs are indicated by the shaded areas.

⁽¹⁾ Screening value based on a RfD of 0.14 mg/kg/day.

TABLE 6-5

**CONTAMINANTS OF POTENTIAL CONCERN
IN GROUNDWATER
SITE 44-JONES STREET DUMP
REMEDIAL INVESTIGATION, CTO-0303
MCB, CAMP LEJEUNE, NORTH CAROLINA**

Contaminant	Minimum Value (µg/L)	Maximum Value (µg/L)	95% UCL of Lognormal Distribution (µg/L)	Location of Maximum Value	Frequency of Detection	Frequency Percentage (%)	Tap Water Screening Value (µg/L)	Exceedance Frequency	Federal MCL (µg/L)	Exceedance Frequency	NCWQS (µg/L)	Exceedance Frequency
Volatiles:												
Vinyl Chloride	10J	10J	6.54	44-TW01-01	1/9	11%	0.019	1/9	2	1/9	0.015	1/9
1,2-Dichloroethene	15	15	7.98	44-TW01-01	1/9	11%	5.5	1/9	70	0/9	NA	NA
Trichloroethene	1J	1J	7.71	44-TW01-01	1/9	11%	1.6	0/9	5	0/9	NA	NA
Tetrachloroethene	1J	1J	7.71	44-GW03-01	1/9	11%	1.1	0/9	5	0/9	0.7	1/9
Semivolatiles:												
Naphthalene	71	71	26.07	44-GW03-01	1/9	11%	150	0/9	NA	NA	21	1/9
2-Methylnaphthalene	4J	4J	5.22	44-GW03-01	1/9	11%	150	0/9	NA	NA	NA	NA
Acenaphthene	13	13	7.51	44-GW03-01	1/9	11%	220	0/9	NA	NA	800	0/9
Dibenzofuran	6J	6J	5.39	44-GW03-01	1/9	11%	15	0/9	NA	NA	NA	NA
Fluorene	7J	7J	5.70	44-GW03-01	1/9	11%	150	0/9	NA	NA	280	0/9
Phenanthrene ⁽¹⁾	7J	7J	5.70	44-GW03-01	1/9	11%	110	0/9	NA	NA	210	0/9
Carbazole	4J	4J	5.22	44-GW03-01	1/9	11%	3.4	1/9	NA	NA	NA	NA
Bis(2-ethylhexyl)phthalate	2J	2J	6.07	44-GW02-01	1/9	11%	4.8	0/9	NA	NA	3	0/9
Inorganics:												
Aluminum	374	2820	125,905.73	44-GW02-01	3/9	33%	3,700	0/9	NA	NA	NA	NA
Arsenic	1.7	2.8	1.64	44-GW04-01	2/9	22%	1.1/0.04	2/9	50	NA	50	0/9
Barium	30.8J	100	443.51	44-GW03-01	5/9	56%	260	0/9	2,000	0/9	2,000	0/9
Calcium	1,290	98,300	687,920.24	44-GW03-01	9/9	100%	NA	NA	NA	NA	NA	NA
Chromium	6.9	6.9	3.53	44-GW02-01	1/9	11%	18	0/9	100	0/9	50	0/9
Cobalt	3.5	3.5	2.24	44-GW04-01	1/9	11%	220	0/9	NA	NA	NA	NA
Iron	285	72,900	8,388,194.94	44-GW04-01	9/9	100%	1,100	5/9	NA	NA	300	8/9
Lead	1.3	1.4	0.99	44-GW02-01	2/9	22%	NA	NA	15	0/9	15	0/9
Magnesium	880	11,900	12,027.05	44-GW03-01	9/9	100%	NA	NA	NA	NA	NA	NA

TABLE 6-5 (Continued)

CONTAMINANTS OF POTENTIAL CONCERN
 IN GROUNDWATER
 SITE 44-JONES STREET DUMP
 REMEDIAL INVESTIGATION, CTO-0303
 MCB, CAMP LEJEUNE, NORTH CAROLINA

Contaminant	Minimum Value (µg/L)	Maximum Value (µg/L)	95% UCL of Lognormal Distribution (µg/L)	Location of Maximum Value	Frequency of Detection	Frequency Percentage (%)	Tap Water Screening Value (µg/L)	Exceedance Frequency	Federal MCL (µg/L)	Exceedance Frequency	NCWQS (µg/L)	Exceedance Frequency
Manganese	21.6	241	627.59	44-GW04-01	8/9	89%	510 ⁽²⁾	0/9	NA	NA	50	5/9
Potassium	1,340	8,160	6,953.62	44-GW03-01	9/9	100%	NA	NA	NA	NA	NA	NA
Selenium	2	2	1.23	44-GW05-01	1/9	11%	18	0/9	50	0/9	50	0/9
Sodium	4,890	74,100	87,872.54	44-GW01DW-01	9/9	100%	NA	NA	NA	NA	NA	NA
Zinc	6.8	16.4	15.97	44-GW04-01	4/9	44%	1,100	0/9	NA	NA	2,100	0/9

Notes:

COPCs are indicated by the shaded areas.

⁽¹⁾ USEPA Region III COC screening value used as a surrogate.

⁽²⁾ Screening value based on a RfD of 0.14 mg/kg/day.

TABLE 6-6

**CONTAMINANTS OF POTENTIAL CONCERN IN SURFACE WATER
SITE 44-JONES STREET DUMP
REMEDIAL INVESTIGATION, CTO-0303
MCB, CAMP LEJEUNE, NORTH CAROLINA**

Contaminants	Minimum Value (µg/L)	Maximum Value (µg/L)	95% UCL of Lognormal Distribution (µg/L)	Location of Maximum Detected Value	Frequency of Detection	Frequency Percentage (%)	Base-Wide Average (µg/L)	Federal Water and Organisms (µg/L)	Federal Organisms only (µg/L)	State Freshwater (µg/L)	Region IV Water and Organisms (µg/L)	Region IV Organisms Only (µg/L)
Volatiles:												
Vinyl Chloride	7J	38	17.87	44-EC-SW08-01	8/16	50%	--	2	525	525	2	525
Acetone	10	13	7.24	44-EC-SW01	3/16	19%	--	--	--	--	--	--
1,1-Dichloroethene	1J	2J	6.20	44-EC-SW06-01	3/16	19%	--	0.057	3.2	--	0.52	39
1,2-Dichloroethene (total)	2J	150	240.61	44-EC-SW01	14/16	88%	--	--	--	--	--	--
Trichloroethene	2J	66	36.30	44-EC-SW01	14/16	88%	--	2.7	81	92.4	2.7	81
1,1,2-Trichloroethane	1J	1J	6.03	44-EC-SW08-01	1/16	6%	--	0.6	42	--	--	--
1,1,2,2-Tetrachloroethane	5J	42	35.11	44-EC-SW08-01	12/16	75%	--	0.17	11	10.8	0.17	11
Semivolatiles:												
Phenol	1J	1J	8.53	44-UT-SW01	1/8	13%	--	21,000	4,600,000	--	21,000	4,600,000
bis(2-Ethylhexyl)phthalate	1J	3J	5.44	44-EC-SW05	6/8	75%	--	--	--	--	1.8	5.9
Inorganics:												
Aluminum	122	509	554.16	44-EC-SW04	7/8	88%	333.17	--	--	--	--	--
Barium	14.5	27.1	31.09	44-EC-SW04	7/8	88%	25.67	--	--	--	--	--
Calcium	33,500	55,500	56,596.51	44-EC-SW05	8/8	100%	17,566.67	--	--	--	--	--
Copper	1.9	2.3	2.65	44-UT-SW03	7/8	88%	ND	--	--	--	1,300	--
Iron	1170	1980	1,862.49	44-EC-SW04	8/8	100%	575.67	--	--	--	--	--
Lead	0.83J	11.2	9.35	44-EC-SW03	2/8	25%	ND	--	--	--	--	--
Magnesium	2530	23300	21,523.81	44-EC-SW05	8/8	100%	1,744.67	--	--	--	--	--
Manganese	38.8	231	148.04	44-EC-SW01	8/8	100%	ND	--	--	--	--	--
Nickel	7.7	21.1	21.73	44-EC-SW01	3/8	38%	ND	610	4600	--	610	4600
Potassium	3,390	10,000	7,255.76	44-EC-SW05	8/8	100%	ND	--	--	--	--	--
Sodium	16,200	195,000	227,754.01	44-EC-SW05	8/8	100%	9,830	--	--	--	--	--
Vanadium	11.7	29.9	75.76	44-EC-SW01	4/8	50%	ND	--	--	--	--	--
Zinc	16.8J	61.3J	89.10	44-EC-SW02	7/8	88%	ND	--	--	--	--	--

Notes:

COPCs indicated by the shaded areas.

TABLE 6-7

**CONTAMINANTS OF POTENTIAL CONCERN IN SEDIMENT
SITE 44-JONES STREET DUMP
REMEDIAL INVESTIGATION, CTO-0303
MCB, CAMP LEJEUNE, NORTH CAROLINA**

Contaminant	Minimum Value	Maximum Value	95% UCL of Lognormal Distribution	Location of Maximum Value	Frequency of Detection	Frequency Percentage (%)	Base-Wide Average	Region IV Criteria ER-L	Region IV Criteria ER-M	ER-L (Long et. al., 1995)	ER-M (Long et. al., 1995)
Volatiles (µg/kg):											
Acetone	15	610J	289.98	44-UT-SD01-06	11/16	69%	--	--	--	--	--
2-Butanone	51	200	28.01	44-UT-SD01-06	2/16	13%	--	--	--	--	--
Semivolatiles (µg/kg):											
Pentachlorophenol	340J	740J	667.18	44-EC-SD01-612	2/16	13%	--	--	--	--	--
Phenanthrene	49J	250J	282.45	44-UT-SD03-612	5/16	31%	--	225	1,380	240	1,500
Carbazole	79J	79J	266.08	44-UT-SD03-612	1/16	6%	--	--	--	--	--
Fluoranthene	95J	740	309.80	44-UT-SD03-612	6/16	38%	--	600	3,600	600	5,100
Pyrene	42J	490	296.93	44-UT-SD03-612	7/16	44%	--	350	2,200	665	2,600
Butylbenzylphthalate	48J	48J	285.00	44-UT-SD02-06	1/16	6%	--	--	--	--	--
Benzo(a)anthracene	50J	170J	288.44	44-UT-SD03-612	3/16	19%	--	230	1,600	261	1,600
Chrysene	44J	460	310.82	44-UT-SD03-612	7/16	44%	--	400	2,800	384	2,800
Bis(2-ethylhexyl)phthalate	160J	870	434.22	44-UT-SD03-612	5/16	31%	--	--	--	--	--
Benzo(b)fluoranthene	52J	600	320.25	44-UT-SD03-612	6/16	38%	--	--	--	--	--
Benzo(k)fluoranthene	49J	200J	278.39	44-UT-SD03-612	3/16	19%	--	--	--	--	--
Benzo(a)pyrene	56J	300J	285.87	44-UT-SD03-612	3/16	19%	--	400	2,500	430	1,600
Benzo(g,h,i)perylene	49J	71J	287.24	44-UT-SD02-06	2/16	13%	--	--	--	--	--
Pesticide/PCBs (µg/kg):											
Aldrin	2.6J	2.6J	1.51	44-UT-SD03-612	1/14	7%	1.05	--	--	--	--
Heptachlor epoxide	5.2J	5.2J	1.86	44-UT-SD03-612	1/14	7%	ND	--	--	--	--
4,4'-DDE	9.3J	310J	99.95	44-UT-SD02-612	16/16	100%	2.42	2	15	2.2	27
4,4'-DBD	5.5J	770	331.86	44-UT-SD02-612	16/16	100%	1.57	2	20	--	--
4,4'-DDT	2.5J	130	20.16	44-EC-SD05-612	10/14	71%	2.20	1	7	1.58	46.1
alpha-Chlordane	2	14J	5.75	44-EC-SD05-612	13/16	81%	1.20	0.5	6	--	--
gamma-Chlordane	2.7J	16J	6.78	44-EC-SD05-612	13/16	81%	1.44	0.5	6	--	--

TABLE 6-7 (Continued)

**CONTAMINANTS OF POTENTIAL CONCERN IN SEDIMENT
SITE 44-JONES STREET DUMP
REMEDIAL INVESTIGATION, CTO-0303
MCB, CAMP LEJEUNE, NORTH CAROLINA**

Contaminant	Minimum Value	Maximum Value	95% UCL of Lognormal Distribution	Location of Maximum Value	Frequency of Detection	Frequency Percentage (%)	Base-Wide Average	Region IV Criteria ER-L	Region IV Criteria ER-M	ER-L (Long et. al., 1995)	ER-M (Long et. al., 1995)
Inorganics (mg/kg):											
Aluminum	556J	12,200J	5,225.89	44-UT-SD01-612	16/16	100%	1,165.57	--	--	--	--
Arsenic	0.34	1.4	1.03	44-UT-SD02-06	11/16	69%	0.37	33	85	8.2	70
Barium	4.9	49.5	17.65	44-UT-SD01-612	16/16	100%	6.46	--	--	--	--
Beryllium	0.11	0.17	0.12	44-EC-SD05-612	2/16	13%	0.09	--	--	--	--
Cadmium	1.2	1.2	0.61	44-EC-SD05-612	1/16	6%	0.04	5	9	1.2	9.6
Calcium	2610	40,000	16,773.73	44-EC-SD01-06	16/16	100%	1,967.14	--	--	--	--
Chromium	2.6	11.1	6.38	44-UT-SD01-612	16/16	100%	1.86	80	145	81	370
Cobalt	0.48	0.48	0.42	44-EC-SD03-612	1/16	6%	ND	--	--	--	--
Copper	1.9	7.7	4.02	44-EC-SD05-612	16/16	100%	0.75	70	390	34	270
Iron	613	5830	3,939.07	44-UT-SD01-612	16/16	100%	433.71	--	--	--	--
Lead	8.4J	56.3J	31.91	44-UT-SD03-612	16/16	100%	0.79	35	110	46.7	218
Magnesium	95.8	637	398.07	44-EC-SD01-06	16/16	100%	45.25	--	--	--	--
Manganese	2	15.9	9.80	44-UT-SD01-06	16/16	100%	3.63	--	--	--	--
Nickel	1.1	4	2.79	44-EC-SD05-612	15/16	94%	ND	30	50	20.9	51.6
Potassium	60.2	299	133.25	44-UT-SD01-612	5/16	31%	ND	--	--	--	--
Selenium	0.47	1.4	0.53	44-UT-SD01-612	4/16	25%	0.19	--	--	--	--
Silver	0.51	0.51	0.29	44-EC-SD05-06	1/16	6%	0.25	1	2.2	1	3.7
Sodium	30.3	224	123.44	44-UT-SD01-612	16/16	100%	ND	--	--	--	--
Vanadium	1.9	15.1	8.99	44-UT-SD01-612	16/16	100%	1.52	--	--	--	--
Zinc	6.3	144	62.17	44-EC-SD05-06	16/16	100%	5.11	120	270	150	410

Notes:

COPCs are indicated by the shaded areas.

TABLE 6-8

**SUMMARY OF EXPOSURE DOSE INPUT PARAMETERS
SITE 44-JONES STREET DUMP
REMEDIAL INVESTIGATION, CTO-0303
MCB, CAMP LEJEUNE, NORTH CAROLINA**

Input Parameter	Units	Receptor					
		Trespasser Child	Trespasser Adult	Adult Military Personnel	Construction Worker	Residential Child	Residential Adult
Surface Soil (mg/kg)							
Ingestion Rate, IR	mg/d	100	50	100	NA	200	100
Fraction Ingested, FI	unitless	1	1	1	NA	1	1
Exposure Frequency, EF	d/y	130	43	250	NA	350	350
Exposure Duration, ED	y	6	30	4	NA	6	30
Surface Area, SA	cm ²	2,000	5,000	4,300	NA	2,300	5,800
Absorption Factor, AF	mg/cm ³	1	1	1	NA	1	1
Averaging Time, Noncarc., ATnc	d	2,190	10,950	1,460	NA	2,190	10,950
Averaging Time, Carc., ATcarc	d	25,550	25,550	25,550	NA	25,550	25,550
Body Weight, BW	kg	15	70	70	NA	15	70
Conversion Factor, CF	kg/mg	1x10 ⁻⁶	1x10 ⁻⁶	1x10 ⁻⁶	NA	1x10 ⁻⁶	1x10 ⁻⁶
Absorbance Factor, ABS	unitless	Organics = 0.01; Inorganics = 0.001					
Subsurface Soil (mg/kg)							
Ingestion Rate, IR	mg/d	NA	NA	NA	480	200	100
Fraction Ingested, FI	unitless	NA	NA	NA	1	1	1
Exposure Frequency, EF	d/y	NA	NA	NA	90	350	350
Exposure Duration, ED	y	NA	NA	NA	1	6	30
Surface Area, SA	cm ²	NA	NA	NA	4,300	2,300	5,800
Absorption Factor, AF	mg/cm ³	NA	NA	NA	1	1	1
Averaging Time, Noncarc., ATnc	d	NA	NA	NA	365	2,190	10,950
Averaging Time, Carc., ATcarc	d	NA	NA	NA	25,550	25,550	25,550
Body Weight, BW	kg	NA	NA	NA	70	15	70
Conversion Factor, CF	kg/mg	NA	NA	NA	1x10 ⁻⁶	1x10 ⁻⁶	1x10 ⁻⁶
Absorbance Factor, ABS	unitless	Organics = 0.01; Inorganics = 0.001					

TABLE 6-8 (Continued)

SUMMARY OF EXPOSURE DOSE INPUT PARAMETERS
 SITE 44-JONES STREET DUMP
 REMEDIAL INVESTIGATION, CTO-0303
 MCB, CAMP LEJEUNE, NORTH CAROLINA

Input Parameter	Units	Receptor					
		Trespasser Child	Trespasser Adult	Adult Military Personnel	Construction Worker	Residential Child	Residential Adult
Groundwater (mg/L)							
Ingestion Rate, IR	L/d	NA	NA	NA	NA	1	2
Exposure Frequency, EF	d/y	NA	NA	NA	NA	350	350
Exposure Duration, ED	y	NA	NA	NA	NA	6	30
Exposure Time, ET	h/d	NA	NA	NA	NA	0.25	0.25
Surface Area, SA	cm ²	NA	NA	NA	NA	10,000	23,000
Averaging Time, Noncarc., ATnc	d	NA	NA	NA	NA	2,190	10,950
Averaging Time, Carc., ATcarc	d	NA	NA	NA	NA	25,550	25,550
Conversion Factor, CF	L/cm ³	NA	NA	NA	NA	0.001	0.001
Body Weight, BW	kg	NA	NA	NA	NA	15	70
Sediment (mg/kg)							
Ingestion Rate, IR	mg/d	200	100	NA	NA	200	100
Fraction Ingested, FI	unitless	1	1	NA	NA	1	1
Exposure Frequency, EF	d/y	45	45	NA	NA	45	45
Exposure Duration, ED	y	6	30	NA	NA	6	30
Surface Area, SA	cm ²	2,000	5,000	NA	NA	2,300	5,800
Absorption Factor, AF	mg/cm ³	1	1	NA	NA	1	1
Averaging Time, Noncarc., ATnc	d	2,190	10,950	NA	NA	2,190	10,950
Averaging Time, Carc., ATcarc	d	25,550	25,550	NA	NA	25,550	25,550
Body Weight, BW	kg	15	70	NA	NA	15	70
Conversion Factor, CF	kg/mg	1x10 ⁻⁶	1x10 ⁻⁶	NA	NA	1x10 ⁻⁶	1x10 ⁻⁶
Absorbance Factor, ABS	unitless	Organics = 0.01; Inorganics = 0.001					

TABLE 6-8 (Continued)

SUMMARY OF EXPOSURE DOSE INPUT PARAMETERS
 SITE 44-JONES STREET DUMP
 REMEDIAL INVESTIGATION, CTO-0303
 MCB, CAMP LEJEUNE, NORTH CAROLINA

Input Parameter	Units	Receptor					
		Trespasser Child	Trespasser Adult	Adult Military Personnel	Construction Worker	Residential Child	Residential Adult
Surface Water (mg/L)							
Ingestion Rate, IR	L/d	0.005	0.005	NA	NA	0.005	0.005
Exposure Time, ET	h/d	2.6	2.6	NA	NA	2.6	2.6
Exposure Frequency, EF	d/y	45	45	NA	NA	45	45
Exposure Duration, ED	y	6	30	NA	NA	6	30
Surface Area, SA	cm ²	2,000	5,000	NA	NA	2,300	5,800
Body Weight, BW	kg	15	70	70	70	15	70
Averaging Time, Noncarc., ATnc	d	2,190	10,950	NA	NA	2,190	10,950
Averaging Time, Carc., ATcarc	d	25,550	25,550	NA	NA	25,550	25,550
Conversion Factor, CF	L/cm ³	0.001	0.001	NA	NA	0.001	0.001
Air (mg/m³)							
Outdoor Air							
Inhalation Rate, IR	m ³ /d	10	20	30	20	10	20
Exposure Frequency, EF	d/y	130	43	250	90	350	350
Exposure Duration, ED	y	6	30	4	1	6	30
Averaging Time, Noncarc., ATnc	d	2,190	10,950	1,460	365	2,190	10,950
Averaging Time, Carc., ATcarc	d	25,550	25,550	25,550	25,550	25,550	25,550
Body Weight, BW	kg	15	70	70	70	15	70
Particulate Emission Factor	m ³ /kg	1.32E+09					

TABLE 6-8 (Continued)

SUMMARY OF EXPOSURE DOSE INPUT PARAMETERS
 SITE 44-JONES STREET DUMP
 REMEDIAL INVESTIGATION, CTO-0303
 MCB, CAMP LEJEUNE, NORTH CAROLINA

Input Parameter	Units	Receptor					
		Trespasser Child	Trespasser Adult	Adult Military Personnel	Construction Worker	Residential Child	Residential Adult
<u>Shower Air</u>							
Inhalation Rate, IR	m ³ /h	NA	NA	NA	NA	0.6	0.6
Exposure Time, ET	h/d	NA	NA	NA	NA	0.25	0.25
Exposure Frequency, EF	d/y	NA	NA	NA	NA	350	350
Exposure Duration, ED	y	NA	NA	NA	NA	6	30
Averaging Time, Noncarc., AT _{nc}	d	NA	NA	NA	NA	2,190	10,950
Averaging Time, Carc., AT _{carc}	d	NA	NA	NA	NA	25,550	25,550
Body Weight, BW	kg	NA	NA	NA	NA	15	70

References:

- USEPA Risk Assessment For Superfund Volume I. Human Health Manual (Part A) Interim Final, December, 1989.
- USEPA Exposure Factors Handbook, July, 1989.
- USEPA Risk Assessment For Superfund Volume I. Human Health Evaluation Manual Supplemental Guidance. "Standard Default Exposure Factors" Interim Final. March 25, 1991.
- USEPA Dermal Exposure Assessment: Principles and Applications. Interim Report. January, 1992.
- USEPA Region IV Guidance for Soil Absorbance. (USEPA, 1992)

Notes:

The exposure frequency for the trespasser receptors is based on the typical exposure pattern (i.e., more time spent outdoors in the warmer months vs. the cooler months) for people who actively garden or play outdoors. It is an upper-bound estimate (USEPA, 1992).

The skin surface area for the trespasser receptors is based on approximately 25 percent of the total surface body area for a child and adult receptor. These values are lower-bound estimates.

TABLE 6-9

**SUMMARY OF EXPOSURE PATHWAYS
SITE 44-JONES STREET DUMP
REMEDIAL INVESTIGATION, CTO-0303
MCB, CAMP LEJEUNE, NORTH CAROLINA**

Receptor	Exposure Pathway
Current Adult Military Personnel	Surface soil ingestion, dermal contact and inhalation of fugitive dusts
Current Adult and Child Trespassers	Surface soil ingestion, dermal contact and inhalation of fugitive dusts Surface water ingestion and dermal contact Sediment ingestion and dermal contact
Future Adult and Child Residents	Surface soil ingestion, dermal contact, and inhalation of fugitive dusts Groundwater ingestion, dermal contact and inhalation Surface water ingestion and dermal contact Sediment ingestion and dermal contact
Future Construction Worker	Subsurface soil ingestion, dermal contact, and inhalation of fugitive dusts

TABLE 6-10

**SUMMARY OF HEALTH-BASED CRITERIA
SITE 44-JONES STREET DUMP
REMEDIAL INVESTIGATION, CTO-0303
MCB, CAMP LEJEUNE, NORTH CAROLINA**

COPCs	RfD (Oral) (mg/kg/d)	RfC (Inhal.) (mg/kg/d)	CSF (Oral) (mg/kg/d) ⁻¹	CSF (Inhal.) (mg/kg/d) ⁻¹	Weight-of-Evidence
VOLATILES					
Acetone	1.0E-01(i)	-	-	-	D
2-Butanone	6.0E-01(i)	2.86E-01(i)	-	-	D
1,2-Dichloroethene (total)	9.0E-03(h)	-	-	-	D
1,1,2,2-Tetrachloroethane	-	-	2.0E-01(i)	2.03E-01(i)	-
1,1-Dichloroethene	9.0E-03(i)	-	6.0E-01(i)	1.75E-01(i)	C
1,1,2-Trichloroethane	4.0E-03(i)	-	5.7E-02(i)	5.6E-02(i)	C
Trichloroethene	6.0E-03(e)	-	1.1E-02(w)	6.0E-03(e)	B2
Vinyl Chloride	-	-	1.9E+00(h)	3.0E-01(h)	A
SEMIVOLATILES					
Benzo(a)anthracene	-	-	7.3E-01(e)	6.1E-01(e)	B2
Benzo(a)pyrene	-	-	7.3E+00(i)	6.1E+00(w)	B2
Benzo(b)fluoranthene	-	-	7.3E-01(e)	6.1E-01(e)	B2
Benzo(g,h,i)perylene ⁽¹⁾	3.0E-02(i)	-	-	-	D
Benzo(k)fluoranthene	-	-	7.3E-02(e)	6.1E-02(e)	B2
Bis(2-ethylhexyl)phthalate	2.0E-02(i)	-	1.4E-02(i)	-	B2
Butylbenzylphthalate	2.0E-01(i)	-	-	-	C
Carbazole	-	-	2.0E-02(h)	-	-
Chrysene	-	-	7.3E-03(e)	6.1E-03(e)	B2
Fluoranthene	4.0E-02(i)	-	-	-	D
Pentachlorophenol	3.0E-02(i)	-	1.2E-01(i)	-	B2
Phenol	6.0E-01(i)	-	-	-	D
Phenanthrene ⁽¹⁾	3.0E-02(i)	-	-	-	D
Pyrene	3.0E-02(i)	-	-	-	D
PESTICIDES					
Aldrin	3.0E-05(i)	-	1.7E+01(i)	1.71E+01(i)	B2
4,4'-DDD	-	-	2.4E-01(i)	-	B2
4,4'-DDE	-	-	3.4E-01(i)	-	B2
4,4'-DDT	5.0E-04(i)	-	3.4E-01(i)	3.4E-01(i)	B2
Heptachlor epoxide	1.3E-05(i)	-	9.1E+00(i)	9.1E+00(i)	B2
alpha-Chlordane ⁽²⁾	6.0E-05(i)	-	1.3E+00(i)	1.3E+00(i)	B2
gamma-Chlordane ⁽²⁾	6.0E-05(i)	-	1.3E+00(i)	1.3E+00(i)	B2

TABLE 6-10 (Continued)

SUMMARY OF HEALTH-BASED CRITERIA
 SITE 44-JONES STREET DUMP
 REMEDIAL INVESTIGATION, CTO-0303
 MCB, CAMP LEJEUNE, NORTH CAROLINA

COPCs	RfD (Oral) (mg/kg/d)	RfC (Inhal.) (mg/kg/d)	CSF (Oral) (mg/kg/d) ⁻¹	CSF (Inhal.) (mg/kg/d) ⁻¹	Weight-of-Evidence
METALS					
Aluminum	1.0E+00	-	-	-	-
Arsenic	3.0E-04(i)	-	1.5E+00(i)	1.5E+01(i)	A
Barium	7.0E-02(i)	1.4E-04(a)	-	-	D
Beryllium	5.0E-03(i)	-	4.3E+00(i)	8.4E+00(i)	B2
Cadmium (water) (food/soil)	5.0E-04(i) 1.0E-03 ⁽³⁾	5.71E-05(e)	-	6.3E+00(i)	B1
Chromium VI	5.0E-03(i)	-	-	42(i)	D
Cobalt	6.0E-02(e)	-	-	-	-
Copper	4.0E-02(e)	-	-	-	D
Iron	3.0E-01(e)	-	-	-	-
Lead	-	-	-	-	B2
Manganese	1.4E-01(i)	1.4E-05(i)	-	-	D
Nickel	2.0E-02(i)	-	-	-	D
Selenium	5.0E-03(i)	-	-	-	D
Silver	5.0E-03(i)	-	-	-	D
Vanadium	7.0E-03(h)	-	-	-	D
Zinc	3.0E-01(i)	-	-	-	D

References:

a = HEAST alternative

e = EPA-NCEA Regional Support Provisional Value

h = HEAST, 1994

i = IRIS, 1995

w = Withdrawn from IRIS or HEAST, but used in assessment, as recommended by Region IV Region III RBC Table, March, 1995

⁽¹⁾ Toxicity values for pyrene were substituted for this constituent.

⁽²⁾ Toxicity values for chlordane were substituted for this constituent.

⁽³⁾ Toxicity value recommended by USEPA Region IV

- = Not applicable or available

TABLE 6-11

SUMMARY OF DERMALLY-ADJUSTED HEALTH-BASED CRITERIA*
SITE 44-JONES STREET DUMP
REMEDIAL INVESTIGATION, CTO-0303
MCB, CAMP LEJEUNE, NORTH CAROLINA

COPCs	Percent Absorbed ⁽¹⁾	Oral RfD mg/kg/d	Oral RfD (Dermally-Adjusted) mg/kg/d	Oral CSF (mg/kg/d) ⁻¹	Oral CSF (Dermally-Adjusted) (mg/kg/d) ⁻¹
VOLATILES					
Acetone	80%	1.00E-01	8.00E-02	--	--
2-Butanone	80%	6.00E-01	4.80E-01	--	--
1,2-Dichloroethene (total)	80%	9.00E-03	7.20E-03	--	--
1,1,2,2-Tetrachloroethane	80%	--	--	2.00E-01	2.50E-01
1,1-Dichloroethene	80%	9.00E-03	7.20E-03	6.0E-01	7.50E-01
1,1,2-Trichloroethane	80%	4.00E-03	3.20E-03	5.70E-02	7.10E-02
Trichloroethene	80%	6.00E-03	4.80E-03	1.10E-02	1.38E-02
Vinyl Chloride	80%	--	--	1.90E+00	2.38E+00
SEMIVOLATILES					
Benzo(a)anthracene	50%	--	-	7.30E-01	1.46E+00
Benzo(a)pyrene	50%	--	-	7.30E+00	1.46E+01
Benzo(b)fluoranthene	50%	--	-	7.30E-01	1.46E+00
Benzo(g,h,i)perylene*	50%	3.00E-02	1.50E-02	--	--
Benzo(k)fluoranthene	50%	--	--	7.30E-02	1.46E-01
Bis(2-ethylhexyl)phthalate	50%	2.00E-02	1.00E-02	1.40E-02	2.80E-02
Butylbenzylphthalate	50%	2.00E-01	1.00E-01	--	--
Carbazole	50%	--	--	2.00E-02	4.00E-02
Chrysene	50%	--	--	7.30E-03	1.46E-02
Fluoranthene	50%	4.00E-02	2.00E-02	--	--
Pentachlorophenol	50%	3.00E-02	1.50E-02	1.20E-01	2.40E-01
Phenanthrene	50%	3.00E-02	1.50E-02	--	--
Phenol	50%	6.00E-01	3.00E-01		
Pyrene	50%	3.00E-02	1.50E-02	--	-
PESTICIDES					
Aldrin	50%	3.00E-05	1.50E-05	1.70E+01	3.40E+01
4,4'-DDD	50%	--	-	2.40E-01	4.80E-01
4,4'-DDE	50%	--	-	3.40E-01	6.80E-01
4,4'-DDT	50%	5.00E-04	2.50E-04	3.40E-01	6.80E-01
Heptachlor epoxide	50%	1.30E-05	6.50E-06	9.10E+00	1.82E+01
alpha-Chlordane	50%	6.00E-05	3.00E-05	1.30E+00	2.60E+00
gamma-Chlordane	50%	6.00E-05	3.00E-05	1.30E+00	2.60E+00

TABLE 6-11 (Continued)

SUMMARY OF DERMALLY-ADJUSTED HEALTH-BASED CRITERIA*
 SITE 44-JONES STREET DUMP
 REMEDIAL INVESTIGATION, CTO-0303
 MCB, CAMP LEJEUNE, NORTH CAROLINA

COPCs	Percent Absorbed ⁽¹⁾	Oral RfD mg/kg/d	Oral RfD (Dermally-Adjusted) mg/kg/d	Oral CSF (mg/kg/d) ⁻¹	Oral CSF (Dermally-Adjusted) (mg/kg/d) ⁻¹
METALS					
Aluminum	20%	1.00E+00	2.00E-01	--	--
Arsenic	20%	3.00E-04	6.00E-05	1.80E+00	7.50E+00
Barium	20%	7.00E-02	1.40E-02	--	--
Beryllium	20%	5.00E-03	1.00E-03	4.30E+00	2.15E+01
Cadmium (water)	20%	5.00E-04	1.00E-04	--	--
Cadmium (soil/sediment)	20%	1.00E-03	2.00E-04	--	--
Chromium	20%	5.00E-03	1.00E-03	--	--
Cobalt	20%	6.00E-02	1.20E-02	--	--
Copper	20%	4.00E-02	8.00E-03	--	--
Iron	20%	3.00E-01	6.00E-02	--	--
Lead	20%	--	--	--	--
Manganese	20%	1.40E-01	2.80E-02	--	--
Nickel	20%	2.00E-02	4.00E-03	---	--
Selenium	20%	5.00E-03	1.00E-03	--	--
Silver	20%	5.00E-03	1.00E-03	--	--
Vanadium	20%	7.00E-03	1.40E-03	--	--
Zinc	20%	3.00E-01	6.00E-02	--	--

Notes:

⁽¹⁾ Region IV recommended values (i.e., 80% for VOCs, 50% for SVOCs/Pesticides, and 20% for Inorganics)

- = Not Applicable

* = Only oral toxicity values were dermally adjusted; inhalation toxicity values were not adjusted.

Dermally-adjusted RfD = oral RfD*percent absorbed

Dermally-adjusted CSF = oral CSF/percent absorbed

References:

IRIS, 1995

HEAST, 1995

Region III RBC Table, March, 1995

TABLE 6-12

**SUMMARY OF RISKS FOR THE
MILITARY RECEPTOR
SITE 44-JONES STREET DUMP
REMEDIAL INVESTIGATION CTO-0303
MCB, CAMP LEJEUNE, NORTH CAROLINA**

Exposure Pathway	Noncarcinogenic Risk	Carcinogenic Risk
Surface Soil		
Ingestion	6.9E-02	2.9E-07
Dermal Contact	1.5E-02	6.2E-08
Inhalation	--	6.6E-10
Total Risk	8.4E-02	3.5E-07

Notes:

-- = Not applicable

TABLE 6-13

**SUMMARY OF RISKS FOR THE
CHILD TRESPASSER
SITE 44-JONES STREET DUMP
REMEDIAL INVESTIGATION CTO-0303
MCB, CAMP LEJEUNE, NORTH CAROLINA**

Exposure Pathway	Noncarcinogenic Risk	Carcinogenic Risk
Surface Soil		
Ingestion	1.7E-01	1.1E-06
Dermal Contact	1.7E-02	1.1E-07
Inhalation	--	1.2E-09
total	1.8E-01	1.2E-06
Surface Water		
Ingestion	4.0E-03	3.9E-07
Dermal Contact	1.7E-02	1.5E-06
total	2.1E-02	1.9E-06
Sediment		
Ingestion	4.3E-02	6.7E-07
Dermal Contact	2.3E-03	9.1E-08
total	4.6E-02	7.7E-07
Current/Future Risk	2.5E-01	3.8E-06

Notes:

-- = Not Applicable

TABLE 6-14

**SUMMARY OF RISKS FOR THE
FUTURE CHILD RESIDENT
SITE 44-JONES STREET DUMP
REMEDIAL INVESTIGATION, CTO-0303
MCB, CAMP LEJEUNE, NORTH CAROLINA**

Exposure Pathway	Noncarcinogenic Risk	Carcinogenic Risk
Surface Soil		
Ingestion	9.0E-01	5.7E-06
Dermal Contact	5.2E-02	3.3E-07
Inhalation	--	3.2E-09
total	9.5E-01	6.0E-06
Groundwater		
Ingestion	1.6E+01	8.2E-05
Dermal Contact	2.0E-01	1.7E-06
Inhalation	--	2.0E-05
total	1.6E+01	1.0E-04
Surface Water		
Ingestion	4.0E-03	3.9E-07
Dermal Contact	2.0E-02	1.7E-06
total	2.4E-02	2.1E-06
Sediment		
Ingestion	4.3E-02	6.7E-07
Dermal Contact	2.6E-03	1.1E-07
total	4.6E-02	7.8E-07
Future Risk	1.7E+01	1.1E-04

Notes:

-- = Not Applicable

Bolded values indicate risk values that exceed the acceptable risk value of 1.0 for noncarcinogenic effects and 1×10^{-4} for carcinogenic effects.

TABLE 6-15

SUMMARY OF RISKS FOR THE
 ADULT TRESPASSER
 SITE 44-JONES STREET DUMP
 REMEDIAL INVESTIGATION, CTO-0303
 MCB, CAMP LEJEUNE, NORTH CAROLINA

Exposure Pathway	Noncarcinogenic Risk	Carcinogenic Risk
Surface Soil		
Ingestion	5.9E-03	1.9E-07
Dermal Contact	3.0E-03	9.3E-08
Inhalation	--	5.7E-10
total	8.9E-03	2.8E-07
Surface Water		
Ingestion	8.5E-04	4.2E-07
Dermal Contact	9.4E-03	4.0E-06
total	1.0E-02	4.4E-06
Sediment		
Ingestion	4.7E-03	3.6E-07
Dermal Contact	1.2E-03	2.4E-07
total	5.9E-03	6.0E-07
Current/Future Risk	2.5E-02	5.3E-06

Notes:

-- = Not Applicable

TABLE 6-16

**SUMMARY OF RISKS FOR THE
FUTURE ADULT RESIDENT
SITE 44-JONES STREET DUMP
REMEDIAL INVESTIGATION, CTO-0303
MCB, CAMP LEJEUNE, NORTH CAROLINA**

Exposure Pathway	Noncarcinogenic Risk	Carcinogenic Risk
Surface Soil		
Ingestion	9.7E-02	3.0E-06
Dermal Contact	2.8E-02	8.8E-07
Inhalation	--	4.6E-09
total	1.2E-01	3.9E-06
Groundwater		
Ingestion	6.8E+00	1.8E-04
Dermal Contact	9.8E-02	4.3E-06
Inhalation	--	1.6E-05
total	6.9E+00	2.0E-04
Surface Water		
Ingestion	8.5E-04	4.2E-07
Dermal Contact	1.1E-02	4.6E-06
total	1.2E-02	5.0E-06
Sediment		
Ingestion	4.7E-03	3.6E-07
Dermal Contact	1.4E-03	2.8E-07
total	6.1E-03	6.5E-07
Future Risk	7.0E+00	2.1E-04

Notes:

-- = Not Applicable

Bolded values indicate risk values that exceed the acceptable risk value of 1.0 for noncarcinogenic effects and the acceptable risk value of 1×10^{-4} for carcinogenic effects.

TABLE 6-17

**SUMMARY OF RISKS FOR THE
CONSTRUCTION WORKER RECEPTOR
SITE 44-JONES STREET DUMP
REMEDIAL INVESTIGATION, CTO-0303
MCB, CAMP LEJEUNE, NORTH CAROLINA**

Exposure Pathway	Noncarcinogenic Risk	Carcinogenic Risk
Subsurface Soil		
Ingestion	6.2E-02	6.3E-08
Dermal Contact	2.8E-03	2.8E-09
Inhalation	--	2.0E-11
Total Risk	6.5E-02	6.6E-08

Notes:

-- = Not Applicable

TABLE 6-18

SUMMARY OF UNCERTAINTIES IN THE RESULTS OF THE
HUMAN HEALTH RISK ASSESSMENT
SITE 44-JONES STREET DUMP
REMEDIAL INVESTIGATION, CTO-0303
MCB, CAMP LEJEUNE, NORTH CAROLINA

	Potential Magnitude for Over-Estimation of Risks	Potential Magnitude for Under-Estimation of Risks	Potential Magnitude for Over or Under-Estimation of Risks
<u>Environmental Sampling and Analysis</u>			
Sufficient samples may not have been taken to characterize the media being evaluated.			Low
Systematic or random errors in the chemical analysis may yield erroneous data.			Low
<u>Selection of COPCs</u>			
The use of USEPA Region III COPC screening concentrations in selecting COPCs in soil and groundwater.			Low
<u>Exposure Assessment</u>			
The standard assumptions regarding body weight, exposure period, life expectancy, population characteristics, and lifestyle may not be representative of the actual exposure situations.			Moderate
The use of the 95th percentile upper confidence level data of the lognormal distribution in the estimation of the RME.			Low
Assessing future residential property use when the likelihood of residential development is low.	High		
The amount of media intake is assumed to be constant and representative of any actual exposure.			Low
<u>Toxicological Assessment</u>			
Toxicological indices derived from high dose animal studies, extrapolated to low dose human exposure.	Moderate		
Lack of promulgated toxicological indices for inhalation pathway.		Low	
<u>Risk Characterization</u>			
Assumption of additivity in the quantitation of cancer risks without consideration of synergism, antagonism, promotion and initiation.			Moderate

TABLE 6-18 (Continued)

**SUMMARY OF UNCERTAINTIES IN THE RESULTS OF THE
HUMAN HEALTH RISK ASSESSMENT
SITE 44-JONES STREET DUMP
REMEDIAL INVESTIGATION, CTO-0303
MCB, CAMP LEJEUNE, NORTH CAROLINA**

	Potential Magnitude for Over-Estimation of Risks	Potential Magnitude for Under-Estimation of Risks	Potential Magnitude for Over or Under-Estimation of Risks
Assumption of additivity in the estimation of systemic health effects without consideration of synergism, antagonism, etc.			Moderate
Additivity of risks by individual exposure pathways (dermal and ingestion and inhalation).	Low		Low
Compounds not quantitatively evaluated.		Low	

Notes:

Low - Assumptions categorized as "low" may effect risk estimates by less than one order of magnitude.

Moderate - Assumptions categorized as "moderate" may effect estimates of risk by between one and two orders of magnitude.

High - Assumptions categorized as "high" may effect estimates of risk by more than two orders of magnitude.

Source: Risk Assessment Guidance for Superfund, Volume 1, Part A: Human Health Evaluation Manual. USEPA, 1989a.

TABLE 6-19

SUMMARY OF CONTAMINANTS CONTRIBUTING TO SITE RISKS
SITE 44-JONES STREET DUMP
REMEDIAL INVESTIGATION CTO-0303
MCB, CAMP LEJEUNE, NORTH CAROLINA

Site and Exposure Medium	Contaminant	Concentration
Site 44 Groundwater	Vinyl Chloride Iron	0.00654 mg/L (95% UCL) 72.9 mg/L (max)

SECTION 6.0 FIGURES

FIGURE 6-1

FLOWCHART OF POTENTIAL EXPOSURE PATHWAYS AND RECEPTORS
SITE 44: JONES STREET DUMP

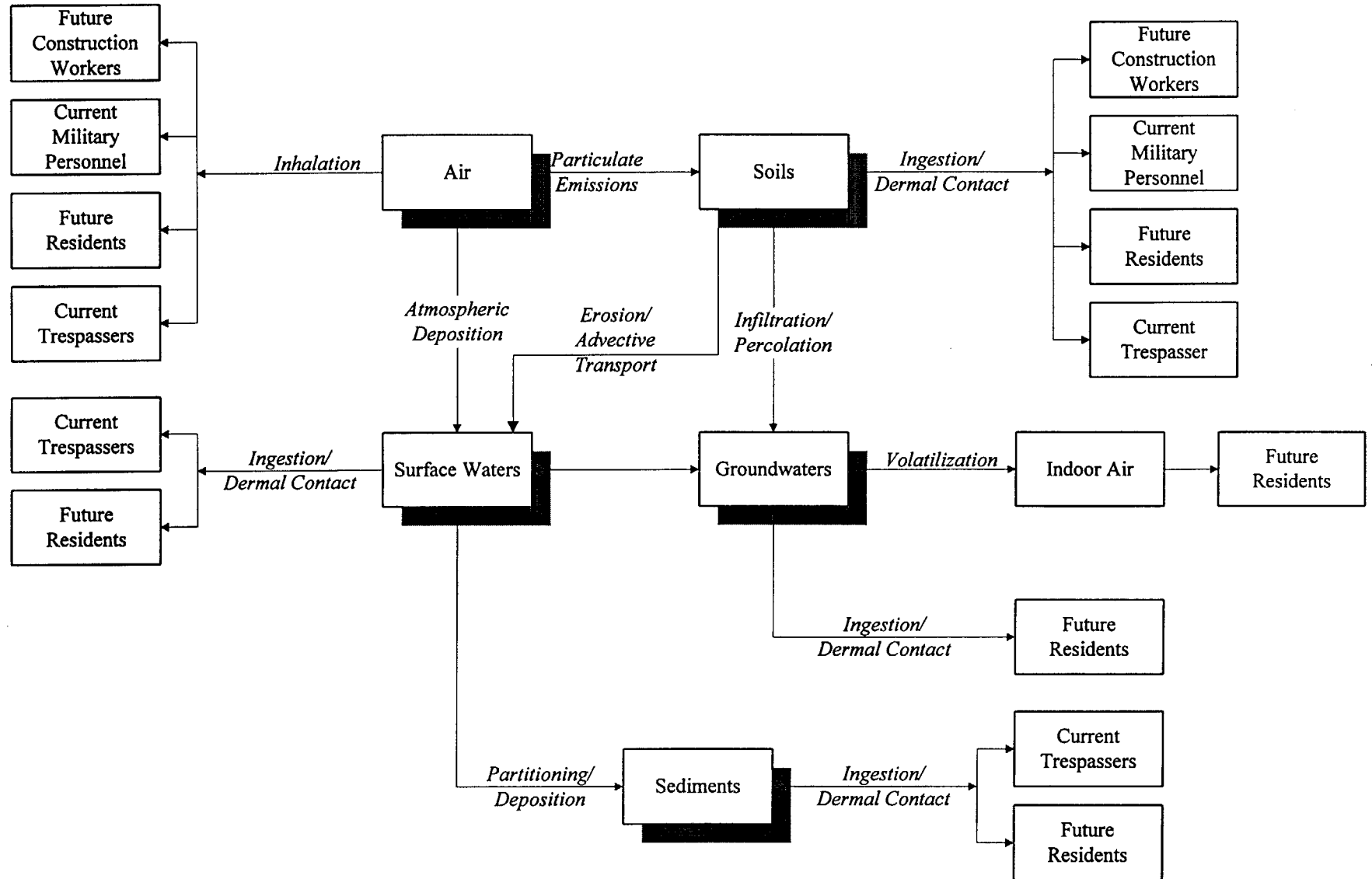

7.0 ECOLOGICAL RISK ASSESSMENT

The Comprehensive Environmental Response, Compensation, and Liability Act of 1980 (CERCLA) as amended by the Superfund Amendments and Reauthorization Act (SARA) of 1986, directs USEPA to protect human health and the environment with respect to releases or potential releases of contaminants from abandoned hazardous waste sites (USEPA, 1989a). This section of the report presents the ecological risk assessment (ERA) conducted at Operable Unit No. 6, Site 44 that assesses the potential impacts to ecological receptors from contaminants detected at this site.

7.1 Objectives, Scope, and Organization of the Ecological Risk Assessment

The objective of this ERA is to evaluate if past reported disposal practices at Site 44 are potentially adversely impacting the terrestrial and aquatic communities on, or adjacent to, the site. This assessment also evaluates the potential effects of contaminants related to Site 44 on sensitive environments including wetlands, protected species, and fish nursery areas. The conclusions of the ERA are used in conjunction with the human health risk assessment to evaluate the appropriate remedial action for this site for the overall protection of public health and the environment. If potential risks are characterized for the ecological receptors, further ecological evaluation of the site and surrounding areas may be warranted.

This ERA evaluates and analyzes the results from the Remedial Investigation (RI) including chemical analysis of the soil, groundwater, surface water, and sediment. In addition, surface water and sediment bioassays were conducted at one station. The media of concern for this ERA are the surface soil, surface water, and sediment. Information used to evaluate sensitive environments is obtained from historical data and previous studies obtained in the literature, or through conversations with appropriate state, Federal, and local personnel.

The risk assessment methodologies used in this evaluation are consistent with those outlined in the Ecological Risk Assessment Guidance for Superfund: Process for Designing and Conducting Ecological Risk Assessments (USEPA, 1994a) and Framework for Ecological Risk Assessment (USEPA, 1992). In addition, information found in the following documents was used to supplement the USEPA guidance document:

- USEPA Supplemental Risk Assessment Guidance for Superfund, Volume II, Environmental Evaluation Manual (USEPA, 1989b)
- Ecological Assessment of Hazardous Waste Sites: A Field and Laboratory Reference (USEPA, 1989c)

Based on the USEPA Framework for Ecological Risk Assessment, an ERA consists of three main components: 1) Problem Formulation; 2) Analysis; and, 3) Risk Characterization (USEPA, 1992). The problem formulation section includes a preliminary characterization of exposure and effects of the stressors to the ecological receptors. During the analysis, the data is evaluated to determine the exposure and potential effects on the ecological receptors from the stressors. Finally, in the risk characterization, the likelihood of adverse effects occurring as a result of exposure to a stressor is evaluated. This section also evaluates the potential impact on the ecological receptors at the site from the contaminants detected in the media. This ERA is organized to parallel these three components.

7.2 Problem Formulation

Problem formulation is the first step of an ERA and includes a preliminary characterization of exposure and effects (USEPA, 1992a). Chemical analyses were performed on samples collected from the soil, groundwater, surface water, and sediment to evaluate the presence, concentrations, and variabilities of the contaminants. A habitat characterization also was conducted as part of the field activities. Based on these observations, potential ecological receptors were identified. Finally, toxicological information for the contaminants detected in the media was obtained from available references and literature and used to evaluate the potential adverse ecological effects to the ecological receptors.

The components of the problem formulation include identifying the stressors and their potential ecological effects, identification of ecosystems potentially at risk, defining ecological endpoints and presenting a conceptual model. The following sections discuss each of these components, and how they are evaluated in this ERA.

7.3 Contaminants of Potential Concern

One of the initial steps in the problem formulation stage of an ERA is identifying the stressors and their potential ecological effects. For this ERA, the stressors that are evaluated include contaminants detected in the surface soil, surface water, and sediment.

Contaminants in the subsurface soil and groundwater are not evaluated in this ERA. Some terrestrial species burrow in the subsurface soil, and microorganisms most likely exist in the groundwater. However, current guidance does not provide sufficient information to evaluate risk to these receptors.

The nature and extent of contaminants detected in the environmental media at Site 44 are presented in Section 4.0 of this report. Sample locations are based on available historical site information and a site visit to evaluate potential ecosystems and ecological receptors.

7.3.1 Criteria for Selecting Contaminants of Potential Concern

Quantifying risk for all positively identified contaminants may distract from the dominant risk-driving contaminants at the site. Therefore, the data set was reduced to a list of contaminants of potential concern (COPCs). COPCs are site-related contaminants used to quantitatively estimate ecological exposures and associated potential ecological effects.

The criteria used in selecting the COPCs from the contaminants detected during the field sampling and analytical phase of the investigation are:

- Historical information
- Prevalence
- Toxicity
- Comparison to Federal and state criteria and standards
- Comparison to investigation associated field and laboratory blank data
- Comparison to background or naturally occurring levels
- Comparison to anthropogenic levels

7.3.1.1 Historical Information

Using historical information to associate contaminants with site activities, when combined with the following selection procedures, helps determine contaminant retention or elimination. To be conservative, contaminants detected in the media that may not have been historically used at a site are retained as COPCs to evaluate risk, but may be eliminated in the ecological significance section as not being site-related.

7.3.1.2 Prevalence

The frequency of positive detections in sample sets and the level at which a contaminant is detected in a given medium are factors that determine a chemical's prevalence. Contaminants that were detected infrequently are not retained as COPCs.

7.3.1.3 Toxicity

The potential toxicity of a contaminant is an important consideration when selecting COPCs for further evaluation in the ERA. Several of the contaminants detected in the media at Site 44 are prevalent, however, their inherent toxicity to aquatic and terrestrial receptors are low (e.g., calcium, magnesium, potassium, and sodium). Therefore, they are not retained as COPCs. In addition, several contaminants have not been adequately studied to develop published toxicity values, or even accepted toxicological data with which to assess the contaminants. Contaminants that fall into this category are retained as COPCs (if they are not eliminated due to other criteria), however, they are not quantitatively evaluated in the ERA.

7.3.1.4 State and Federal Criteria and Standards

Water Quality Standards (WQS) for surface water have been developed for North Carolina (NC DEHNR, 1994). These are the only enforceable surface water standards. In addition to the WQS, Water Quality Screening Values (WQSVs) have been developed by USEPA Region IV (USEPA, 1995a), USEPA Region III (USEPA, 1995b), and Oak Ridge National Laboratory (ORNL) (Suter and Mabrey, 1994). The WQS and WQSVs will be herein referred to as Surface Water Screening Values (SWSVs).

Sediment quality standards have not been developed for North Carolina. However, Sediment Screening Values (SSVs) are available for many contaminants. These SSVs include the following: Sediment Screening Levels (SSLs) (Long et. al, 1995; Long and Morgan, 1991; and, USEPA, 1995b), calculated sediment quality criteria (SQC) (USEPA, 1993a), Apparent Effect Threshold values (AET) (Tetra-Tech, Inc., 1986), and Wisconsin Department of Natural Resources interim guidance criteria for in-water disposal of dredged sediments (Sullivan, et. al., 1985).

The SWSVs and SSVs are used for comparative purposes to infer potential ecological risks. Contaminants that were detected at concentrations less than these screening values are not retained as COPCs for aquatic receptors since contaminants detected at concentrations less than these values are not expected to pose a significant risk to the aquatic receptor population. However, these contaminants may be retained as COPCs for the terrestrial receptors.

There are no state or Federal soil screening values that can be used to evaluate potential ecological risks to terrestrial receptors (other than plants or invertebrates). Therefore, toxicity of contaminants

in the surface soil to terrestrial receptors is not used as criteria for retaining COPCs except for calcium, magnesium, potassium, and sodium, which are not retained as COPCs in any of the media.

A brief explanation of the standards, criteria, and screening values used for the evaluation of the COPCs is presented below.

North Carolina Water Quality Standards (Surface Water) - WQS are the concentrations of toxic substances that will not result in chronic toxicity to aquatic life (NCDEHNR, 1994). WQS are provided for both freshwater and saltwater aquatic systems.

USEPA Water Quality Screening Values - WQSVs are non-enforceable regulatory guidelines and are of primary utility in assessing acute and chronic toxic effects in aquatic systems. WQSVs are provided for both freshwater and saltwater aquatic systems, and are reported as acute and/or chronic values (USEPA, 1995a,b). Most of the WQSVs are the same as the USEPA Ambient Water Quality Criteria (AWQC), however, some of the WQSVs are based on more current studies.

Oak Ridge National Laboratory Aquatic Benchmarks - ORNL Aquatic Benchmarks are developed for many contaminants, including those that do not have WQS or WQSVs (Suter and Mabrey, 1994). The ORNL aquatic benchmarks include secondary acute values and secondary chronic values that are calculated using the Tier II method described in the EPA's Proposed Water Quality Guidance for the Great Lakes System (USEPA, 1993b). Tier II values are developed so that aquatic benchmarks could be established with fewer data than are required for the USEPA AWQC. The benchmarks are limited to contaminants in freshwater.

Sediment Screening Levels - Sediment Screening Levels (SSLs) have been compiled to evaluate the potential for contaminants in sediments to cause adverse biological effects (Long, et. al, 1995; Long and Morgan 1991; and, USEPA, 1995b). The lower ten percentile (Effects Range-Low [ER-L]) and the median percentile (Effects Range-Median [ER-M]) of biological effects have been developed for several contaminants. The concentration below the ER-L represents a minimal-effects range (adverse effects would be rarely observed). The concentration above the ER-L but below the ER-M represents a possible-effects range (adverse effects would occasionally occur). Finally, the concentration above the ER-M represents a probable-effects range (adverse effects would probably occur).

In addition to the SSLs, Apparent Effects Threshold (AET) Sediment Quality Values have been developed by Tetra Tech Inc., (1986) for the Puget Sound. AETs are the concentrations of contaminants above which statistically significant biological effects would always be expected. Finally, the Wisconsin Department of Natural Resources has developed interim criteria for in-water disposal of dredged sediments (Sullivan, et. al., 1985). However, these criteria are established using background data and are not based on aquatic toxicity.

Sediment Quality Criteria - Currently, promulgated sediment quality criteria (SQC) only exist for a few contaminants. However, SQC for nonionic organic compounds can be calculated using the procedures in the Technical Basis for Deriving Sediment Quality Criteria for Nonionic Organic Contaminants for the Protection of Benthic Organisms by using Equilibrium Partitioning (USEPA, 1993a) as follows:

$$SQC = (Foc)(Koc)(FCV)/1,000,000$$

Where:

SQC = sediment quality criteria ($\mu\text{g}/\text{kg}$)
Foc = sediment organic carbon content (mg/kg)
Koc = chemical organic carbon partition coefficient (mL/g)
FCV = final chronic water quality value ($\mu\text{g}/\text{L}$)

7.3.1.5 Field and Laboratory Blank Data

Associating contaminants detected in field related blanks (i.e., trip blanks, equipment rinsates and/or field blanks) or laboratory method blanks with the same contaminants detected in analytical samples can eliminate non-site-related contaminants from the list of COPCs. Blank data should be compared to sample results with which the blanks are associated. However, for this data set it is difficult to associate specific blanks with specific environmental samples. Thus, in order to evaluate detection levels, maximum contaminant concentrations reported in a given set of blanks are applied to a corresponding set of samples.

In accordance with the National Functional Guidelines for Organics, common lab contaminants (i.e., acetone, 2-butanone, methylene chloride, toluene, and phthalate esters) should be regarded as a direct result of site activities only when sample concentrations exceed 10 times the maximum blank concentration. For other contaminants not considered common in a lab, concentrations exceeding 5 times the maximum blank concentration indicates contamination resulting from site activities (USEPA, 1991a).

Contract Required Quantitation Limits (CRQLs) and percent moisture are employed when evaluating contaminant concentrations in soil, in order to correlate solid and aqueous detection limits. For example, the CRQL for semivolatiles in soil is 33 to 66 times that of aqueous samples, depending on the contaminant. In order to assess semivolatile contaminant levels in soil using aqueous blanks, the blank concentration must then also be multiplied by 33 or 66 to account for variance from the CRQL (common lab contaminants must first be multiplied by 5 or 10, as explained in the paragraph above). The final value is divided by the sample percent moisture.

Eliminating a sample result correlates directly to a reduction in the contaminant prevalence in that medium. Consequently, if elimination due to blank concentration reduces the prevalence of a contaminant to less than 5 percent, a contaminant that may have been included according to its prevalence is eliminated as a COPC.

Maximum concentrations of common laboratory contaminants detected in blanks are presented in Section 6.0, Table 6-1. Blanks containing organic constituents that are not considered common laboratory contaminants (i.e., all other TCL compounds) are regarded as positive results only when observed concentrations exceed 5 times the maximum concentration detected in any blank (USEPA, 1989a). All TCL compounds at less than 5 times the maximum level of contamination noted in any blank are considered not detected in that sample.

7.3.1.6 Background or Naturally Occurring Levels

Contaminants that were detected in the surface soil at concentrations less than two-times the average Base background concentration are not retained as COPCs. As presented in Section 4.0, off-site surface water and sediment samples were collected from several waterbodies in the White Oak River water basin. The contaminant concentrations in the site samples and the off-site background

samples are compared to each other to determine if contaminant concentrations in the site stations are below naturally occurring regional levels.

The two water bodies sampled at Site 44 are Edwards Creek and Strawhorn Creek. The majority of the samples are tidally influenced. Therefore, the mid-stream saltwater off-site background surface water and sediment samples are compared to the Site 44 samples to determine if contaminant concentrations are within background concentrations. Contaminants that were detected in the surface water or sediment at concentrations less than the average background concentration are not retained as COPCs.

7.3.1.7 Anthropogenic Levels

Ubiquitous anthropogenic background concentrations result from non-site related sources such as combustion of fossil fuels (i.e., automobiles), plant synthesis, natural fires and factories. Examples of ubiquitous, anthropogenic chemicals are polycyclic aromatic hydrocarbons (PAHs). Anthropogenic chemicals are typically not eliminated as COPCs without considering other selection criteria. It is difficult to determine that such chemicals are present at the site due to operations not related to the site or the surrounding area. Omitting anthropogenic background chemicals from the risk assessment may result in the loss of important information for those potentially exposed.

The following sections apply the aforementioned selection criteria beginning with the prevalence of detected analytical results in each medium of interest to establish a preliminary list of COPCs for Site 44. Once this task has been completed, a final list of media-specific COPCs will be selected based on the remaining criteria.

7.3.2 **Selection of Contaminants of Potential Concern**

The following sections present an overview of the analytical data obtained for each medium during the RI and the subsequent retention or elimination of COPCs using the aforementioned selection criteria. Contaminants that are not eliminated due to the above criteria are retained as COPCs. The primary reasons for retaining contaminants as COPCs include, but may not be limited to the following: (1) frequently detected, (2) detected at concentrations above the screening values (if available) and/or (3) detected at concentrations above background (if available). In addition, some common laboratory contaminants (i.e., phthalates, acetone) are retained as COPCs because they were detected frequently and were not detected in the blank samples. Finally, calcium, magnesium, potassium, and sodium are not retained as COPCs in any of the media because they are common naturally occurring chemicals, are not related to the site, and no published toxicity data was identified to assess potential impacts to aquatic or terrestrial life.

Tables 7-1 and 7-2 present the comparison of the total and dissolved surface water contaminant concentrations to the SWSVs and the off-site background sample contaminant concentrations, respectively. Table 7-3 presents the comparison of the sediment contaminant concentrations to applicable SSVs and the off-site background sample contaminant concentrations. A comparison of the surface soil contaminant concentrations to base-background concentrations is presented in Section 6.0, Table 6-3. A summary of the COPCs retained in each media is presented in Table 7-4.

7.3.2.1 Surface Soil

Thirteen surface soil samples were collected at Site 44. All the samples were analyzed for TCL VOCs, SVOCs, pesticides/PCBs, and TAL metals (dissolved and total).

Acetone was the only VOC detected in the surface soil. It is retained as a COPC. Five SVOCs were detected in the surface soil. All the SVOCs [benzo(g,h,i)perylene, bis(2-chloroethyl)ether, bis(2-ethylhexyl)phthalate, 2,6-dinitrotoluene, and indeno(1,2,3-cd)pyrene) are retained as COPCs. Three pesticides (4,4'-DDD, 4,4'-DDE, and 4,4'-DDT) were detected and retained as COPCs in the surface soil.

Seventeen metals were detected in the surface soil. Cobalt, nickel, and selenium are not retained as COPCs because they were detected at concentrations less than two times the base-wide background concentration. As presented above, calcium, magnesium, potassium, and sodium are not retained as COPCs. The remaining ten metals (aluminum, arsenic, barium, chromium, copper, iron, lead, manganese, vanadium, and zinc) are retained as COPCs.

7.3.2.2 Surface Water

Sixteen surface water samples were collected at Site 44 in Edwards Creek and the unnamed tributary to Edwards Creek. Sixteen samples were analyzed for TCL VOCs, while eight samples were analyzed for SVOCs, pesticides/PCBs, and TAL metals. The eight additional VOC samples were collected to verify the presence of VOCs in the surface water, and to trace the source of the VOC contamination.

The sample stations are freshwater or slightly tidally influenced. Therefore, the freshwater off-site background surface water and sediment samples are compared to the Site 44 samples to determine if contaminant concentrations in the Site 44 media are within background concentrations. This is a conservative approach since most of the contaminants in the freshwater off-site background samples were detected at lower concentrations than they were detected in the mid-stream saltwater off-site background samples. The contaminant concentrations in the surface water are compared to the saltwater screening values, since most of the samples are tidally influenced to some degree, and the water bodies are classified as saltwater by the state of North Carolina.

Seven VOCs were detected in the surface water. 1,1-Dichloroethene, 1,2-dichloroethene, 1,1,2,2-tetrachloroethane, trichloroethene, and vinyl chloride are not retained as COPCs for aquatic receptors because they were detected at concentrations below the SWSVs. Acetone and 1,1,2-trichloroethane are the only VOCs retained as COPCs in the surface water samples for both the aquatic and terrestrial receptors. Two SVOCs [bis(2-ethylhexyl)phthalate and phenol] were detected in the surface water but they are not retained as COPCs for the aquatic receptors because they were detected at concentrations below the SWSVs. No pesticides or PCBs were detected in the surface water.

Thirteen metals (total) were detected in the surface water. Copper, vanadium, and zinc are not retained as COPCs for the aquatic receptors because they were detected at concentrations below the SWSVs. As presented above, calcium, magnesium, potassium, and sodium are not retained as COPCs for either the aquatic or terrestrial receptors. The remaining six metals (aluminum, barium, iron, lead, manganese, and nickel) are retained as COPCs for both the aquatic and terrestrial receptors.

Thirteen metals (dissolved) were detected in the surface water. Vanadium and zinc are not retained as COPCs for the aquatic receptors because they were detected at concentrations below the SWSV. As presented above, calcium, magnesium, potassium, and sodium are not retained as COPCs for the aquatic receptors. The remaining seven metals (aluminum, barium, copper, iron, lead, manganese, and nickel) are retained as COPCs for the aquatic receptors.

7.3.2.2 Sediment

Sixteen sediment samples were collected at Site 44 in Edwards Creek and the unnamed tributary to Edwards Creek. At each sediment station, samples were collected from two depths, 0 to 6 inches and 6 to 12 inches. All the samples were analyzed for TCL VOCs, SVOCs, pesticides/PCBs, and TAL metals, while selected samples were analyzed for total organic carbon (TOC). The lowest TOC value was used to calculate the SQC screening values, since this is the most conservative approach for the initial screening. Appendix V contains the SQC calculations.

Two VOCs (acetone and 2-butanone) were detected and retained as COPCs in the sediment. Thirteen SVOCs were detected in the sediment samples. Benzo(a)anthracene, benzo(a)pyrene, benzo(b)fluoranthene, benzo(k)fluoranthene, benzo(g,h,i)perylene, bis(2-ethylhexyl)phthalate, and pyrene are not retained as COPCs because they did not exceed the SSVs. Butylbenzylphthalate, carbazole, chrysene, fluoranthene, pentachlorophenol, and phenanthrene are retained as COPCs. Seven pesticides were detected in the sediment. Aldrin, 4,4'-DDD, 4,4'-DDE, 4,4'-DDT, alpha-chlordane, gamma-chlordane, heptachlor epoxide all are retained as COPCs.

Twenty metals were detected in the sediment. Arsenic, barium, beryllium, cadmium, chromium, copper, iron, manganese, nickel, silver and zinc are not retained as COPCs because they do not exceed their respective SSVs. As presented above, calcium, magnesium, potassium, and sodium are not retained as COPCs. The remaining five metals (aluminum, cobalt, lead, selenium, and vanadium) are retained as COPCs.

7.3.3 Physical/Chemical Characteristics of COPCs

Physical and chemical characteristics of contaminants may affect their mobility, transport, and bioavailability in the environment. These characteristics include bioconcentration factors (BCFs), organic carbon partition coefficient (K_{oc}), octanol water partition coefficient (K_{ow}), and biotransfer factors (B_v, B_b, B_r). Table 7-5 summarizes these values for the COPCs detected in the surface soil, surface water and sediment. Information from these tables is used to assess the fate and transport of the contaminants and the potential risks to the environmental receptors at Site 44. The following paragraphs present the significance of each parameter included in the table.

Bioconcentration factors measure the tendency for a chemical to partition from the water column or sediment and concentrate in aquatic organisms. Bioconcentration factors are important for ecological receptors because chemicals with high BCFs could accumulate in lower-order species and subsequently accumulate to toxic levels in species higher up the food chain. The BCF is the concentration of the chemical in the organism at equilibrium divided by the concentration of the chemical in the water. Therefore, the BCF is unitless. The bioconcentration factor is used in the terrestrial intake model to estimate the COPC concentration in fish that may be ingested by the raccoon.

The organic carbon partition coefficient (K_{oc}) measures the tendency for a chemical to partition between soil or sediment particles containing organic carbon and water. This coefficient is important in the ecological environment because it determines how strongly an organic chemical will be bound to the organics in the sediments. The K_{oc} is used to calculate sediment quality criteria.

The octanol/water partition coefficient (K_{ow}) is the ratio of a chemical concentration in octanol divided by the concentration in water. The octanol/water partition coefficient has been shown to correlate well with bioconcentration factors in aquatic organisms and with adsorption to soil or sediment. The K_{ow} is used to calculate the plant and beef biotransfer factors (for organics) that are used to estimate the COPC concentration in plants and the small mammal that may be ingested by the terrestrial receptors in the intake model.

The plant biotransfer factors (B_v or B_r) measure the potential for a chemical to accumulate in a plant. These factors are used to calculate the concentration of the COPCs in the leafy part of the plant (B_v) or the fruit of the plant (B_r). The factors for inorganics are obtained from Baes et. al, (1984), while the factors for organics are calculated according to Travis and Arms (1988). The B_v and B_r values for the organics are assumed to be same value.

Finally, the beef biotransfer factor (B_b) measures the potential for a chemical to accumulate in an animal. This factor is used to calculate the COPC concentration in the small mammal that is ingested by the red fox. The factors for inorganics are obtained from Baes et. al.(1984), while the factors for organics are calculated according to Travis and Arms (1988).

7.4 Ecosystems Potentially at Risk

Ecological receptors that might be potentially at risk from contaminants at Site 44 were identified during the field investigations and the habitat evaluation. The regional ecology is presented in Section 1.0 of this RI, while the site specific ecology is presented in Sections 2.0. Based on the results of the field investigations and the habitat evaluation, potential receptors of contaminants in surface water and sediment include the following: fish, benthic macroinvertebrates, other aquatic flora and fauna and some terrestrial faunal species. Potential receptors of contaminants in soil include the following: deer, rabbits, foxes, raccoons, birds and other terrestrial flora and fauna.

7.5 Ecological Endpoints

The information compiled during the first stage of problem formulation (stressor characteristics and ecosystems potentially at risk) is used to select the ecological endpoints for this ERA. There are two primary types of ecological endpoints: assessment endpoints and measurement endpoints. Assessment endpoints are environmental characteristics, which, if they are found to be significantly affected, may indicate a need for remediation (e.g., decrease in sports/fisheries). Measurement endpoints are quantitative expressions of an observed or measured effect of the contamination of concern. Measurement endpoints may be identical to assessment endpoints (e.g., measurement of abundance of fish), or they may be used as surrogates for assessment endpoints (e.g., toxicity test endpoints). Both types of endpoints are used in the ecological risk evaluation and are presented in the following sections.

A measurement endpoint, or "ecological effects indicator" as it is sometimes referred, is used to evaluate the assessment endpoint. Therefore, measurement endpoints must correspond to, or be

predictive of, assessment endpoints. In addition, they must be readily measurable, preferably quickly and inexpensively, using existing techniques. Measurement endpoints must take into consideration the magnitude of the contamination and the exposure pathway. The measurement endpoint should be an indicator of effects that are temporally distributed. Low natural variability in the endpoint is preferred to aid in attributing the variability in the endpoint to the contaminant. Measurement endpoints should be diagnostic of the pollutants of interest, as well as broadly applicable to allow comparison between sites and regions. Also, measurement endpoints should be standardized (e.g., standard procedures for toxicity tests). Finally, it is desirable to use endpoints that already are being measured (if they exist) to determine baseline conditions.

7.5.1 Aquatic Endpoints

The assessment endpoints for the aquatic receptors are potential decreases in the survival, growth, and/or reproduction of the aquatic receptor population or subpopulation that is attributable to site-related contaminants. The first measurement endpoint for the aquatic assessment endpoint includes decreased survival and growth of Pimephales promelas and Chironomus tentans, decreased survival and reproduction of Ceriodaphnia dubia, and decreased survival of Hyaella azteca as compared to controls. The second measurement endpoint is the exceedance of contaminant-specific surface water and sediment effect concentrations (i.e., SWSVs, and SSVs).

7.5.2 Terrestrial Endpoints

The assessment endpoint for the terrestrial receptors is the potential reduction of a receptor population or subpopulation that is attributable to contaminants from the site. The measurement endpoints for the terrestrial ERA include exceedances of contaminant-specific soil effect concentrations (i.e., SSSVs) and contaminant-specific effect doses (TRVs).

7.6 Conceptual Model

This section of the ERA presents each potential exposure pathway via soil, groundwater, surface water, sediment, and air, and the likelihood that an exposure will occur through these pathways. Figure 7-1 presents the flowchart of potential exposure pathways and ecological receptors.

To determine if ecological exposure via these pathways may occur in the absence of remedial actions, an analysis is conducted including the identification and characterization of the exposure pathways. The following four elements are examined to determine if a complete exposure pathway is present:

- A source and mechanism of chemical release
- An environmental transport medium
- A feasible receptor exposure route
- A receptor exposure point

7.6.1 Soil Exposure Pathway

Potential release sources to be considered in evaluating the soil pathway are surface or buried wastes and contaminated soil. The release mechanisms to be considered are fugitive dust, leaching, tracking, and surface runoff. The transport medium is the soil. The potential routes to be considered for ecological exposure to the contaminated soil are ingestion and dermal contact. Potential

exposure points for ecological receptors include species living in, or coming in contact with, the soil. COPCs were detected in the surface soil demonstrating a release from a source to the surface soil transport medium. Potential receptors that may be exposed to contaminants in surface soil at/or around surface soil in the areas of detected COPCs include the following: deer, fox, raccoon, rabbits, birds, plants, and other terrestrial life.

Terrestrial receptors potentially are exposed to contaminants in the soil through ingestion, dermal contact, and/or direct uptake (for flora). The magnitude of the exposure depends on their feeding habits and the amount of time they reside in the contaminated soil. In addition, terrestrial species may ingest organisms that have bioconcentrated contaminants from the soil. This exposure pathway is likely to occur at Site 44 and will be retained for further analysis.

7.6.2 Groundwater Exposure Pathway

The potential release source to be considered in evaluating the groundwater pathway is contaminated soil. The release mechanism to be considered is leaching. The routes to be considered for ecological exposure to the contaminated groundwater are ingestion and dermal contact. Groundwater discharge to area surface waters may represent a pathway for contaminant migration.

Sub-surface biota (i.e., microorganisms) are the only ecological receptors expected to be directly exposed to groundwater. Potential impacts to these biota are not assessed in this ERA because current guidance does not provide sufficient information to evaluate risk. In addition, since the receptors of concern are not directly exposed to groundwater at Site 44, the groundwater to surface water exposure is accounted for in the surface water section of the ERA.

7.6.3 Surface Water and Sediment Exposure Pathway

Potential release sources to be considered in evaluating the surface water and sediment pathways are contaminated surface soil and groundwater. The release mechanisms to be considered are groundwater seepage and surface runoff. The potential routes to be considered for ecological exposure to the contaminated surface water/sediment are ingestion and dermal contact. Potential exposure points for ecological receptors include species living in, or coming in contact with, the surface water/sediment on-site or downgradient of the site. COPCs were detected in the surface water and sediment demonstrating a release from a source to the surface water or sediment transport medium. Potential receptors that may be exposed to contaminants in surface water and sediment include the following: fish, benthic macroinvertebrates, deer, birds, and other aquatic and terrestrial life.

Aquatic receptors are exposed to contaminants in the surface water and sediment by ingesting water while feeding and by direct contact while feeding or swimming. This exposure pathway is likely to occur at Site 44 and will be evaluated in the ERA. In addition, aquatic organisms may ingest other aquatic flora and fauna that have bioaccumulated chemicals from the surface water and sediment. This potential exposure pathway will not be evaluated in the ERA because current guidance does not provide sufficient information to evaluate risk.

Terrestrial faunal receptors potentially are exposed to contaminants in the surface water and sediment through ingestion and dermal contact. The magnitude of the exposure depends on their feeding habits and the amount of time they reside in the contaminated waters. In addition, terrestrial species may ingest organisms (e.g., fish, small mammals, invertebrates, and plants) that have

bioconcentrated contaminants from the surface water and sediment. These exposure pathways are likely to occur at Site 44. However, only the surface water and surface soil ingestion pathway will be evaluated in the ERA. Current guidance does not exist to evaluate the sediment pathway or dermal contact pathway for terrestrial receptors, therefore, these pathways will not be evaluated in the ERA.

7.6.4 Air Exposure Pathway

There are two potential release mechanisms to be considered in evaluating the atmospheric pathway release of contaminated particulates and volatilization from surface soil, groundwater and surface water. The potential exposure points for receptors are areas on or adjacent to the site. The air exposure pathway is not evaluated in this ERA because air sampling was not conducted and current guidance does not provide sufficient information to evaluate risk

7.7 Exposure Assessment

The next phase after the problem formulation is the exposure assessment that consists of quantifying the potential exposure of the stressors (COPCs) to the ecological receptors.

The RI included collecting samples for analytical analysis from four media; soil, groundwater, surface water, and sediment. As presented earlier in the ERA, contaminants in the subsurface soil and groundwater are not evaluated. The analytical results for the data used in ERA are presented in Section 4.0 of this report.

The regional ecology, site ecology, and habitat characterization in the areas surrounding Site 44 are presented in Sections 1.0 and 2.0 of this report. Information on sensitive environments and endangered species also is included in this section. Exposure of contaminants in the surface soil to terrestrial flora and fauna (invertebrates and microorganisms) are assumed to be equal to the contaminant concentration in the surface soil. It is noted in the uncertainty section of this ERA that all the contaminants in the surface soil may not be bioavailable to the terrestrial flora or fauna. Exposure of contaminants in the surface water and sediment to aquatic receptors are assumed to be equal to the contaminant concentration in the surface water and sediment. Exposure of contaminants in the surface soil and surface water to other terrestrial fauna (mammals, birds) is estimated using chronic daily intake models (see Section 7.8.5 of this report).

The following sections present the results of the ecosystem characterization including the biological sampling, abiotic habitat, and biotic habitat.

7.7.1 Surface Water, Sediment, and Bioassay Sampling

Water quality measurements were collected during the surface water, sediment, and bioassay sampling event prior to the sample collection. These measurements consisted of temperature, pH, specific conductance, salinity, and dissolved oxygen. Site specific descriptions, and field water quality measurements were recorded on field data sheets (see Appendix T). The station locations and sampling procedures for collecting each of the environmental media are presented in Section 2.0 of this report.

7.7.1.1 Abiotic Habitat

The abiotic habitat consists of the description of the stations with regard to size of the creek, depth of the water, substrate type, water chemistry and other such non-biological descriptors. The following sections present the abiotic habitat for the sampling stations at Site 44.

Table 7-6 presents the sampling station characterization summary that includes the stream width and depth, canopy cover, sediment type, and sediment odor of the Site 44 stations and the upstream stations. The stream width ranged from 3 to 20 feet, while the stream depth ranged from 0.5 to 2 feet. The canopy cover ranged from partly shaded to shaded. Finally, the sediment ranged from a silty-sand, to a coarse sand/gravel mix. The sediment had a normal, anaerobic, and/or petroleum odor.

Table 7-7 presents the results of the field chemistry including the temperature, pH, dissolved oxygen concentration, conductivity, and salinity. The temperature ranged from 13.0 to 18.5 °C, the pH ranged from 3.58 to 7.32 S.U., the dissolved oxygen ranged from 0.7 to 8.2 mg/L, the conductivity ranged from 320 to 5,400 umhos/cm, and the salinity ranged from 0 to 4.1 ppt. The field chemistry at these stations appears to be typical of surface waters at MCB, Camp Lejeune based on Baker's previous sampling experience.

7.7.1.2 Bioassay Procedures

Baker Environmental, Inc. (Baker) contracted with RMC Environmental Services, Inc. (RMC) to conduct surface water and sediment bioassays for one sample collected in Strawhorn Creek. Appendix W contains the laboratory methods used to conduct the bioassays.

RMC conducted 7-day survival and growth bioassays using the fathead minnow (Pimephales promelas), and survival and reproduction bioassays using the cladoceran (Ceriodaphnia dubia) with the surface water sample. The tests were conducted following procedures outlined in the following documents: Methods for Measuring the Acute Toxicity of Effluents to Freshwater and Marine Organisms, Fourth Edition (USEPA, 1990) and Short-Term Methods for Estimating the Chronic Toxicity of Effluents and Receiving Waters to Freshwater Organisms (USEPA, 1989d).

P. promelas larvae and young C. dubia (<24 hr old at test initiation) were exposed to the surface water samples for 7 days under static renewal conditions (i.e., the test solution was replaced daily with freshly prepared solution). The tests were conducted with 100 percent sample, along with sample dilutions of 50 percent, 25 percent, 12.5 percent, and 6.25 percent. A control sample consisting of 100 percent dilution water also was tested. Survival of the minnows was recorded daily while the growth of the minnows (as weight gain/loss) was recorded at the end of 7 days. Survival and reproduction of the C. dubia were recorded daily.

RMC conducted 10-day chronic survival bioassays using the amphipod Hyalella azteca, and growth and survival bioassays using the midge Chironomus tentans with the sediment sample. The tests were conducted in accordance with the Methods for Measuring the Toxicity and Bioaccumulation of Sediment Associated Contaminants with Freshwater Invertebrates, (USEPA, 1994b).

Ten day old H. azteca and third instar C. tentans were exposed to the sediment samples for ten days under static renewal conditions. The overlying water was replaced twice daily, however, the

sediment was not replaced or diluted. Survival of the *H. azteca*, and survival and growth (as weight gain/loss) of the *C. tentans* were recorded at the end of 10 days.

RMC used moderately hard reconstituted water for the surface water control, dilution water, and the overlying water for the sediment samples. Baker provided RMC with a sediment sample from Frenchs Creek (assumed to be uncontaminated) that was used as the control sediment. The bioassay results of the Site 44 samples were statistically compared to the bioassay results of the control samples to determine if there was a statistically significant difference in effects (i.e., survival, growth, reproduction) between the samples.

7.7.1.3 Bioassay Results

The three measurement endpoints for the surface water bioassays are the No Observed Effect Concentration (NOEC), the Lowest Observed Effect Concentration (LOEC), and the Lethal Concentration for 50 percent of the test organisms (LC₅₀). The NOEC is the highest sample concentration that does not show a significant difference in effects between the site sample and the control sample. For example, a NOEC of 100 percent sample indicates that the survival or growth of *P. promelas* is not significantly different between the undiluted (100 percent) site sample and the control sample. The LOEC is the lowest sample concentration that shows a statistical difference in effects between the site sample and the control sample. For example, a LOEC of 50 percent sample for the *P. promelas* indicates that there is a significant difference in growth or survival between the site sample (diluted by 50 percent) and the control sample. Finally, the LC₅₀ is the sample concentration that is expected to be lethal to half of the test organisms in a given time period. The LC₅₀ is calculated using on the survival data. The table below summarizes the results of the surface water bioassays.

Species	Survival		Growth		Reproductive		LC ₅₀
	NOEC	LOEC	NOEC	LOEC	NOEC	LOEC	
<i>Pimephales promelas</i>	100%	100%	100%	100%	NM	NM	100%
<i>Ceriodaphnia dubia</i>	50%	100%	NM	NM	50%	50%	100%

Note: All values in percentage of sample
 NM - Not Measured
 NOEC - No Observed Effects Concentration
 LOEC - Lowest Observed Effects Concentration
 LC₅₀ - Lethal Concentration of 50% of the test organisms over a given time period

The results in the above table indicate that survival and growth of the *P. promelas* in the Site 44 sample is not significantly different

The results of the bioassays indicate that survival and growth of the *P. promelas* in the undiluted (100 percent) Site 44 sample is not significantly different from the survival and growth of the *P. promelas* in the control sample (NOEC). The survival of *C. dubia* in the undiluted sample is significantly different from the survival of *C. dubia* in the control sample, while no significant survival effect is observed between the control sample and the diluted (50 percent) Site 44 sample.

Therefore, the lowest concentration where a significant survival effect is observed in the 100 percent Site 44 sample, and is thus designated as the LOEC. There is not a significant difference in reproduction of C. dubia between the control sample and the diluted (50 percent) Site 44 sample. The 100 percent site sample was not included in the reproduction evaluation since there was a significant survival effect in this sample. Therefore, both the NOEC and the LOEC are 50 percent. Finally, the 48-hr LC₅₀ is 100 percent sample for fathead minnow and the C. dubia.

Current procedures for sediment bioassays do not allow for the dilution of sediment with clean sediment to test the effects of different sediment concentrations. Therefore, it is not possible to calculate a NOEC, LOEC or LC₅₀. The sediment bioassay did not reveal a significant difference in survival of H. azteca between the control sample and the Site 44 sample, or survival and growth of C. tentans between the control sample and the Site 44.

7.8 Ecological Effects Characterization

The ecological effects data that were used to assess potential risks to aquatic and/or terrestrial receptors in this ERA include aquatic and terrestrial screening values as presented in Section 7.3.2 to aid in the selection of the COPCs. The following sections present a summary of the ecological effects comparison.

7.8.1 Surface Water

Contaminant concentrations detected in the surface water at Site 44 were compared to the saltwater SWSVs to determine if there were any exceedances of the published values (see Tables 7-1 and 7-2).

In summary, lead, manganese, and nickel were the only contaminants (total) that exceeded any of the SWSVs. Copper, lead, manganese, and nickel were the only dissolved contaminants detected in the surface water that exceeded any of the SWSVs. No saltwater SWSVs were available for acetone, 1,1,2-trichloroethane, aluminum, barium, or iron.

In the Quality Criteria for Water-1986, it is reported that soluble barium concentrations in marine waters generally would have to exceed 50,000 µg/L before toxicity to aquatic life would be expected (USEPA, 1987). Therefore, the maximum barium concentrations in the surface water samples (27.1 µg/L-total, and 22.4 µg/L-dissolved) are below the concentrations that are expected to cause adverse impacts to aquatic life.

The source for the SWSV for manganese of 10 µg/L is not known. However, AQUIRE reports that 10 µg/L caused decreased growth in the pacific oyster (Crassostrea gigas). This study, which did not meet the criteria for reliability, may be the data source for the Region III value. Other toxicity values for manganese from AQUIRE listed adverse effects at 20,000 µg/L which is higher than the maximum sample concentration collected at Site 44 (231 µg/L-total, and 33.3 µg/L-dissolved). These studies also were conducted with mollusk species.

The maximum concentrations of iron (1,980 µg/L-total, 654 µg/L-dissolved) in the surface water are above the concentrations that caused adverse impacts to aquatic life of some of the studies obtained from the Aquatic Information Retrieval Database (AQUIRE) (100 to 330,000 µg/L). However, the majority of the effect concentrations from the studies on AQUIRE are several orders of magnitude above the maximum iron concentration detected in the surface water. Most of the studies on iron in AQUIRE were conducted with various marine phytoplankton cultures.

7.8.2 Sediment

Contaminant concentrations detected in the sediment at Site 44 were compared to SSVs to determine if there were any exceedances of the published values (see Table 7-3). Butylbenzylphthalate, chrysene, fluoranthene, pentachlorophenol and phenanthrene are the only SVOCs that exceeded a SSV. Aldrin, alpha-chlordane, gamma-chlordane, 4,4'-DDD, 4,4'-DDE, 4,4'-DDT, and heptachlor epoxide are the only pesticides that exceeded a SSV. Finally, lead and selenium are the only metals that exceeded a SSV. No SSVs are available for acetone, 2-butanone, carbazole, aluminum, cobalt, or vanadium.

7.8.4 Surface Soil

Although promulgated standards do not exist, Surface Soil Screening Values (SSSVs) that can be used to evaluate potential ecological risks to terrestrial flora and fauna have been developed by USEPA Region III (USEPA, 1995b) and Oak Ridge National Laboratory (Will and Suter, 1994a, 1994b). The contaminant concentrations in the surface soils are compared to the SSSVs to determine if potential impacts to terrestrial flora and fauna invertebrates may be expected (see Table 7-8).

Benzo(g,h,i)perylene, indeno(1,2,3-cd)pyrene, 4,4'-DDE, 4,4'-DDT, aluminum, chromium, copper, iron, vanadium, and zinc were detected in the surface soil at concentrations exceeding the SSSVs. No SSSVs were available for acetone, bis(2-chloroethyl)ether, or 2,6-dinitrotoluene).

Much of the study area at Site 44 is heavily vegetated with dense understory and trees greater than three inches in diameter. Therefore, ecological receptors have a high potential for becoming exposed to contaminants in the surface soil.

7.8.5 Terrestrial Chronic Daily Intake Model

In addition to comparing the soil concentrations to toxicity values for terrestrial invertebrates and plants, a terrestrial Chronic Daily Intake (CDI) Model is used to estimate the exposure of the COPCs to terrestrial receptors. The following paragraphs describe the procedures used to evaluate the potential soil exposure to terrestrial fauna at Site 44 by both direct and indirect exposure to COPCs via surface water, soil, and foodchain transfer.

Based on the regional ecology and potential habitat at the site, the indicator species used in this analysis are the white-tailed deer, cottontail rabbit, red fox, raccoon, and the bobwhite quail. The exposure points for these receptors are the surface soil, surface water, and biota. The routes for terrestrial exposure to the COPCs in the soil and water are incidental soil ingestion, drinking water, vegetation (leafy plants, seeds and berries) ingestion, fish ingestion, and ingestion of small mammals.

7.8.5.1 Derivation of Terrestrial Reference Value

Total exposure of the terrestrial receptors to the COPCs in the soil and surface waters is determined by estimating the CDI dose and comparing this dose to Terrestrial Reference Values (TRVs) representing acceptable daily doses in mg/kg/day. The CDI equations were adapted from those used in Scarano et. al., (1993). The TRVs were developed from No-Observed-Adverse-Effect-Levels (NOAELs) or Lowest-Observed-Adverse-Effect-Levels (LOAELs) obtained from the Integrated

Risk Information System (IRIS), Agency for Toxic Substances and Disease Registry Toxicological Profiles, mineral tolerance levels of domestic animals (NAS, 1992) or other toxicological data in the literature. Appendix X presents the methodology used in deriving the TRVs and the animals that were used to derive each TRV.

7.8.5.2 Calculation of Chronic Daily Intake

Potential impacts of the terrestrial receptors to the COPCs in the soil and surface water are determined by estimating the CDI dose and comparing this dose to TRVs representing acceptable daily doses in mg/kg/day. The estimated CDI dose of the bobwhite quail, cottontail rabbit, white-tailed deer and small mammal, to soil, surface water, and vegetation is determined using the following equation:

$$CDI = \frac{(C_w)(I_w) + [(C_s)(B_v)(I_v) + (C_s)(I_s)][H]}{BW}$$

Where:

CDI	=	Chronic Daily Intake, mg/kg/d
C _w	=	Contaminant concentration in the surface water, mg/L
I _w	=	Rate of drinking water ingestion, L/d
C _s	=	Contaminant concentration in soil, mg/kg
B _v	=	Soil to plant transfer coefficient (leaves, stems, straw, etc.), unitless
I _v	=	Rate of vegetation ingestion, kg/d
I _s	=	Incidental soil ingestion, kg/d
H	=	Contaminated area/Home area range area ratio, unitless
BW	=	Body weight, kg

To calculate the contaminant concentration in the small mammal, the resulting CDI from the above equation is multiplied by the biotransfer factor for beef (B_b) for organics (Travis and Arms, 1988) and metals (Baes, et. al., 1984).

The estimated CDI dose of the raccoon is determined using the following equation.

$$CDI = \frac{(C_w)(I_w) + (C_f)(I_f) + [(C_s)(B_r)(I_v) + (C_s)(I_s)][H]}{BW}$$

Where:

CDI	=	Chronic Daily Intake, mg/kg/d
C _w	=	Contaminant concentration in the surface water, mg/L
I _w	=	Rate of drinking water ingestion, L/d
C _f	=	Contaminant concentration in the fish, mg/kg
I _f	=	Rate of fish ingestion, kg/d
C _s	=	Contaminant concentration in soil, mg/kg
B _r	=	Soil to plant transfer coefficient (fruit, seeds, tubers, etc.), unitless
I _v	=	Rate of vegetation ingestion, kg/d
I _s	=	Incidental soil ingestion, kg/d
H	=	Contaminated area/Home area range area ratio, unitless
BW	=	Body weight, kg

The contaminant concentration in the fish is calculated by multiplying the bioconcentration factor by the surface water concentration.

The estimated CDI dose of the red fox is determined using the following equation:

$$CDI = \frac{(C_w)(I_w) + [(C_s)(B_v)(I_v) + (C_s)(I_s) + (C_m)(I_m)](H)}{BW}$$

Where:

CDI	=	Chronic Daily Intake, mg/kg/d
C _w	=	Contaminant concentration in the surface water, mg/L
I _w	=	Rate of drinking water ingestion, L/d
C _s	=	Contaminant concentration in soil, mg/kg
B _v	=	Soil to plant transfer coefficient (leaves, stems, straw, etc.), unitless
I _v	=	Rate of vegetation ingestion, kg/d
I _s	=	Incidental soil ingestion, kg/d
C _m	=	Contaminant concentrations in small mammals, mg/kg
I _m	=	Rate of small mammal ingestion, kg/d
H	=	Contaminated area/Home area range area ratio, unitless
BW	=	Body weight, kg

Bioconcentration of the COPCs to plants is calculated using the soil to plant transfer coefficient (B_v or B_r) for organics (Travis and Arms, 1988) and metals (Baes et. al., 1984). The concentrations of the COPCs used in the models are the lower of the upper 95 percent confidence limit or the maximum concentration detected of each COPC. The exposure parameters used in the CDI calculations are presented in Table 7-9.

7.9 Risk Characterization

The risk characterization is the final phase of a risk assessment. It is at this phase that the likelihood of adverse effects occurring as a result of exposure to a stressor is evaluated. This section evaluates the potential decrease in aquatic and terrestrial populations at Site 44 from contaminants identified at the site.

A Quotient Index (QI) approach is used to characterize the risk to aquatic receptors from exposure to contaminants in the surface water and sediment and terrestrial receptors from exposure to contaminants in the surface soil, surface water, and biota. This approach characterizes the potential effects by comparing exposure levels of COPCs in the surface water and sediments to the aquatic reference values presented in Section 7.8, Ecological Effects Characterization. The QI is calculated as follows:

$$QI = \frac{(EC \text{ or } CDI)}{(SWSV, SSV, \text{ or } TRV)}$$

Where:	Quotient Index
	EC = Exposure Concentration, µg/L, µg/kg or mg/kg
	CDI = Chronic Daily Intake, mg/kg/day
	SWSV = Surface Water Screening Value, µg/L

SSV = Sediment Screening Value, $\mu\text{g}/\text{kg}$ or mg/kg
TRV = Terrestrial Reference Value, $\text{mg}/\text{kg}/\text{day}$

A QI of greater than "unity" is considered to be indicative of potential risk. Such values do not necessarily indicate that an effect will occur but only that a lower threshold has been exceeded. It is important to determine which contaminants are posing the highest risks, in order to evaluate the significance of those contaminants to the site. Therefore, the evaluation of the significance of the QI has been judged as follows: (Menzie et. al., 1993)

- QI exceeds "1" but less than "10": some small potential for environmental effects
- QI exceeds "10": significant potential that greater exposures could result in effects based on experimental evidence
- QI exceeds "100": effects may be expected since this represents an exposure level at which effects have been observed in other species

The risks characterized above provide insight into general effects upon animals and plants in the local population. However, depending on the endpoint selected, they may not indicate if population-level effects will occur.

7.9.1 Surface Water

Table 7-10 presents the surface water QIs. Figure 7-2 graphically displays the QIs that exceed "1". See Appendix V for the QI calculations. In summary, copper (dissolved), lead (total and dissolved), manganese (total and dissolved), and nickel (total and dissolved) were the only surface water COPCs with QIs greater than "1". With the exception of the manganese samples, all the QIs were less than "5". The QIs for manganese ranged from "1.1 to 23.1".

7.9.2 Sediment

Table 7-11 presents the sediment QIs. Figure 7-2 graphically displays the QIs that exceed "1". See Appendix V for the QI calculations. The SQC QIs for the organics are calculated on a per-station basis using the sample-specific TOC values. When TOC was not collected in a specific sample, the lowest TOC value in that waterbody was used to calculate the SQC. Chrysene, fluoranthene, pentachlorophenol and phenanthrene are the only SVOCs with QIs that exceeded "1". All the QIs were less than "3" with the exception of the butylbenzylphthalate SQC QI of 84.2. Overall, only a slight risk to aquatic receptors is expected from SVOCs in the sediment since most of the QI are relatively low, and they are detected infrequently.

Alpha-chlordane, gamma-chlordane, 4,4'-DDD, 4,4'-DDE, 4,4'-DDT, and heptachlor epoxide were the only pesticides detected in the sediment samples with QIs that exceeded "1". Most of the samples had ER-M and SQC QIs that were less than "10". However, several samples had QIs that exceeded "100". Stations 44-UT-SD02, 44-EC-SD02 and 44-EC-SD05 had the highest pesticide detections. Therefore, there is a moderate to high potential for adverse impacts to aquatic receptors from pesticides in the sediment.

Lead and selenium are the only metals detected in the sediment samples with QIs that exceeded "1". All the ER-L QIs were less than "2", while all the ER-M QIs are less than "1". Therefore, only a slight risk to aquatic receptors is expected from metals in the sediment.

7.9.3 Terrestrial Chronic Daily Intake Model

Table 7-12 presents the QI for the terrestrial CDI model. Appendix X contains the CDI spreadsheets. The cottontail rabbit (QI=8.5) and the raccoon (QI=12.1) are the only species with QIs that exceeded "1". Aluminum (QI=3.5), iron (QI=1.6) and vanadium (QI=1.7) are the COPCs that account for the majority of the QI value in the rabbit. Aluminum (QI=11.7) is the COPC that accounts for the majority of the QI value in the raccoon. No other COPCs had individual QIs that exceeded "1".

7.10 Ecological Significance

This section essentially summarizes the overall risks to the ecology at the site. It addresses impacts to the ecological receptors at Site 44 from the COPCs detected in the media. This section also summarizes which COPCs are impacting the receptors to the greatest degree, and what contaminants are site-related "significant". This information, to be used in conjunction with the human health risk assessment, supports the selection of remedial action(s) for Site 44 that are protective of public health and the environment.

7.10.1 Aquatic Receptors

With the exception of the additional upstream surface water samples that were collected to evaluate the extent of the VOC contamination, all the surface water and sediment samples were collected either adjacent to, or downstream of Site 44. Copper (dissolved), lead (total and dissolved), manganese (total and dissolved), and nickel (total and dissolved) are the only surface water COPCs with that exceeded the SWSVs. It is generally regarded among the scientific community that dissolved metal more closely approximates the bioavailable fraction of metal in the water column than does total recoverable metal (USEPA, 1993f). Therefore, there is a potential for these copper, lead, and nickel to adversely impact aquatic life in the areas where the SWSVs were exceeded. It should be noted that these exceedences only occurred at a few stations, and are not expected to cause a significant decrease in the aquatic life population in Edwards Creek.

As presented in the Section 7.8.1 (Ecological Effects) of this ERA, the source of the manganese SWSV is not known. However, it appears to be based on a study conducted with mollusks. Other studies conducted with mollusks indicate that the concentration of manganese in the surface water is lower than the concentrations that may cause a potential decrease in the population of aquatic life. Therefore, there is not sufficient data to determine if the concentration on manganese would cause a decrease in the population of aquatic life. In addition, manganese does not appear to be site-related.

Total and dissolved iron are above the concentrations reported to cause adverse impacts to marine phytoplankton. However, similar to manganese, there are not enough data to determine if the detected concentration of iron in the surface water is expected to cause a decrease in the aquatic receptor population.

Four SVOCs were detected in the sediment at concentrations slightly exceeding the ER-L, but did not exceed the ER-M. Two of the SVOCs slightly exceeded the SQC value. One SVOC (butylbenzylphthalate) was detected in the sediment with a SQC QI of 84.2 at Station 44-UT-SD02. However, it did not exceed the ER-L value, and it only was detected in one sample. Three of these SVOCs were detected at Station 44-UT-SD03, indicating a potential "hot spot". However, based on the relatively low exceedences of the SSVs, and/or the infrequency of the detection, there is a low potential for these contaminants to cause a decrease in the population of aquatic life. It should be noted that petroleum odors were detected in sediment samples 44-EC-SD04, 44-EC-SD05, and 44-UT-SD02. Butylbenzylphthalate was the only SVOC detected in one of these samples that exceeded a SSV. As presented in Section 4.0 of this report, there is a lift station that discharges to the unnamed tributary. This lift station may be the source of the SVOCs since they are detected in the unnamed tributary, and the stations adjacent to the tributary (44-EC-SD04 and 44-EC-SD05).

Six pesticides were detected in the sediment at concentrations exceeding the SSVs. Base on the QIs, 4,4'-DDD, 4,4'-DDE, and 4,4'-DDT were the pesticides that contributed highest to the risk to aquatic life. The highest pesticide concentrations were detected at Stations 44-UT-SD02, 44-EC-SD02 and 44-EC-SD05. The source of the pesticides is not known since pesticides reportedly were not stored or disposed at Site 44. In addition, since the high pesticide concentrations were detected in non-adjacent locations and were detected at concentrations typical of MCB, Camp Lejeune (See Section 4.0). Therefore, the pesticides may be due to the periodic pesticide spraying that occurred on the base.

Lead and selenium are the only metals detected in the sediment at concentrations that exceeded the ER-L. However, neither metal exceeds the ER-M. Therefore, there is a low potential for these metals in the sediment to decrease the aquatic receptor population. It should be noted that both lead exceedences were located at 44-UT-SD03, the same location as the SVOC "hot spot". The selenium exceedence occurred at station 44-UT-SD01.

The bioassay samples were collected at station 44-EC-SW/SD02. This station had a relatively high concentration of pesticides in the sediment, along with concentrations of manganese and nickel at concentrations that exceeded the SWSV. For the surface water bioassay, adverse survival effects were observed in the *C. dubia* bioassay. However, no adverse survival or growth effects were observed in the *P. promelas* bioassay. The reason for the decreased survival of the *C. dubia* may be the metals detected in the surface water. The differences in results between the two samples may be due to interspecies differences in sensitivities to the contaminants in the surface water. No decrease in survival or growth of *H. azteca* or *C. tentans* was observed in the Site 44 sediment sample.

7.10.2 Terrestrial Receptors

Several SVOCs, pesticides, and metals were detected in the surface soil at concentrations that exceed the SSSVs. No SSSVs were available for some of the COPCs, therefore, potential adverse impacts to terrestrial invertebrates and plants from these contaminants could not be evaluated. Much of the study area at Site 44 is heavily vegetated with dense understory and trees greater than three inches in diameter. Therefore, ecological receptors have a high potential for becoming exposed to contaminants in the surface soil.

The cottontail rabbit and the raccoon are the only terrestrial species with estimated CDI values that exceeded the TRV values. Aluminum, iron, and vanadium in the cottontail rabbit model, and aluminum in the raccoon model, contributed the majority of the exceedences in these models. These

contaminants are not related to past site activities, and are common naturally occurring metals. Therefore, they are not considered to be site-related.

7.10.3 Threatened and Endangered Species

No threatened or endangered species are present at Site 44.

7.10.4 Wetlands

As presented on the Biohabitat Map in Section 2.0, several wetland areas are present at Site 44. The wetlands border Edwards Creek and the Unnamed Tributary on both sides. The only samples collected in the wetlands were collected in the surface water and sediment in the waterbodies adjacent to the wetlands. Potential impacts to aquatic and terrestrial receptors exposed to contaminants in these media are evaluated in other sections of this ERA.

7.11 Uncertainty Analysis

The procedures used in this evaluation to assess risks to ecological receptors, as in all such assessments, are subject to uncertainties. The following discusses some of the uncertainty in this ERA.

The chemical sampling program at Site 44 consisted of sixteen surface water samples, and eight saltwater sediment samples. Because there were less than twenty samples, contaminants could not be eliminated because of infrequency. Therefore, contaminants not related to the site may have been retained as COPCs and thus carried through the ERA.

There is uncertainty in the ecological endpoint comparison. The SWSVs (WQS and AWQC) are established to be protective of a majority of the potential receptors. However, some species may not be protected by the values because of their increased sensitivity to the chemicals. In addition, most of the values are established using laboratory tests, where the concentrations of certain water quality parameters (pH, hardness, total organic carbon) that may influence toxicity are most likely at different concentrations in the site water.

Potential adverse impacts to aquatic receptors from contaminants in the sediments were evaluated by comparing the COPC concentration in the sediments to SSVs. These SSVs have more uncertainty associated with them than do the SWSVs, since the procedures for developing them are not as established as those used in developing SWSLs. In addition, sediment type (pH, acid volatile sulfide, total organic carbon) also has a significant impact on the bioavailability and toxicity of contaminants.

Potential adverse impacts to terrestrial invertebrates and plants were evaluated by comparing the COPC concentration in the soil to SSSVs. Most of these studies do not account for the soil type, which may have a large influence on the toxicity of the contaminants. For example, soil with high organic carbon content will tend to sorb many of the organic COPCs, thus making them less bioavailable to terrestrial receptors. In addition, most of the SSSVs are based on one or two studies, which greatly adds to their uncertainty.

There are some differences of opinion found in the literature as to the effectiveness of using models to predict concentrations of contaminants found in terrestrial species. According to one source, the

food chain models currently used incorporate simplistic assumptions that may not represent actual site conditions, bioavailability of contaminants, or site-specific behavior of the receptors. Simple food chain models can provide an effective means of initial characterization of risk, however, residue analyses, toxicity tests, and the use of biomarkers provide a better approach for assessing exposure (Menzie et. al., 1993).

There are several sources of uncertainty when using these models. First, most of the terrestrial reference values are based on toxicity data from another species, which is then extrapolated to the species of concern using a body-size scaling equation. Since the toxicity of all contaminants may not be proportional to body size, the calculated TRVs may not accurately predict risk to the species of concern. Another source of uncertainty with the models is that many of the input parameters are based on default values (i.e., ingestion rate) that may or may not adequately represent the actual values of the parameters. In addition, there is uncertainty in the amount that the indicator species will represent other species potentially exposed to COPCs at the site. There is uncertainty in use of the bioconcentration and biotransfer factors. Bioconcentration and biotransfer factors can vary widely from species to species. The species used in the calculation of the bioconcentration and biotransfer factors are different than the species that actually occur at the site. Therefore, use of the factors will tend to either overestimate or underestimate actual bioaccumulation of contaminants. Finally, terrestrial receptors also may be exposed to contaminants in the sediments. However, currently, there is no guidance in the literature that can be used to evaluate this potential exposure pathway.

The toxicity of chemical mixtures is not well understood. All the toxicity information used in the ERA for evaluating risk to the ecological receptors is for individual chemicals. Chemical mixtures can affect the organisms very differently than the individual chemicals due to synergistic or antagonistic effects. In addition, the species that were used to develop the toxicity data may not be present at the site, or have the potential to exist at the site. Depending on the sensitivity of the tested species to the species at the site use of the toxicity values may overestimate or underestimate risk. Many chemicals are not acutely toxic, however, they have the potential to bioaccumulate in ecological receptors through food chain transfer. This bioaccumulation potential typically is not taken into account when comparing contaminant concentrations to screening values.

Finally, toxicological data for several of the COPCs were limited or do not exist. Therefore, there is uncertainty in any conclusions involving the potential impacts to aquatic receptors from these contaminants

7.12 Conclusions

7.12.1 Aquatic Receptors

As presented earlier in the ERA, the assessment endpoints for the aquatic receptors are potential decreases in the survival, growth, and/or reproduction of the aquatic receptor population or subpopulation that is attributable to site-related contaminants. These assessment endpoints are evaluated using a series of measurement endpoints. This section of the ERA examines each of the measurement endpoints to determine if the assessment endpoints are impacted.

The first measurement endpoint is decreased survival and growth of P. promelas and C. tentans, decreased survival and reproduction of C. dubia, and decreased survival of H. azeteca as compared to controls. The bioassay samples were collected at station 44-EC-SW/SD02 in an area of relatively

high pesticide detections (several orders of magnitude greater than the SSSVs). Manganese and nickel concentrations slightly exceeded the SWSVs at this station. For the surface water bioassay, adverse survival effects were observed in the *C. dubia* bioassay, however, no adverse survival or growth effects were observed in the *P. promelas* bioassay. Therefore, the metals in the surface water may be causing a decrease in survival of *C. dubia*. No decrease in survival or growth of *H. azteca* or *C. tentans* was observed in the Site 44 sediment sample.

The second measurement endpoint is determining if the contaminant concentrations in the surface water and sediment exceed the contaminant-specific surface water and sediment effect concentrations (i.e., SWSVs, and SSVs). Several metals, SVOCs, and pesticides were detected in the surface water and/or sediment at concentrations above the SWSVs or SSVs. Based on the screening value comparison, there is a moderate to high potential for a decrease in the population of aquatic receptors from pesticides in the sediments. There is only a low potential for a decrease in the population of aquatic receptors from metals in the surface water and sediment, and SVOCs in the sediment, since the concentration of these contaminants only slightly exceeded the screening values or were detected infrequently.

It should be noted that the highest pesticide concentrations were detected at Stations 44-UT-SD02, 44-EC-SD02 and 44-EC-SD05 while elevated lead and SVOC concentrations were detected at Station 44-UT-SD03. The source of the pesticides is not known since pesticides reportedly were not stored or disposed at Site 44. In addition, since the high pesticide concentrations were detected in non-adjacent locations, the pesticides may be due to the periodic pesticide spraying that occurred on the base. Lead was detected at low concentrations in the groundwater (maximum detection of 1.4 µg/L) and surface soil (maximum detection of 31.7 mg/kg). Therefore, the lead in the surface water (maximum detection 11.2 µg/L) and sediment (maximum detection 56.3 mg/kg) does not appear to be site-related. Phenanthrene was the only SVOC in the sediment that was detected in the groundwater (7 µg/L), and none of the SVOCs in the sediment were detected in the surface soil. Therefore, it does not appear that the SVOCs in the sediment are site-related, but may be related to a lift station that discharges into the unnamed tributary.

Several VOCs were detected in the surface water. Based on the comparison to screening values there does not appear to be a risk to aquatic species. It should be noted, however, that the source of the VOCs originates upstream of Site 44, based on the additional sampling event.

7.12.2 Terrestrial Receptors

As presented earlier in the ERA, the assessment endpoints for the terrestrial receptors is the potential reduction of a receptor population or subpopulation that is attributable to contaminants from the site. This section evaluates this assessment endpoint using the measurement endpoints.

The first measurement endpoint is determining if there is an exceedances of contaminant-specific soil effect concentrations (i.e., SSSVs). Several SVOCs, pesticides, and metals were detected in the surface soil at concentrations that exceed the SSSVs. Much of the study area at Site 44 is heavily vegetated with dense understory and trees greater than three inches in diameter. Therefore, ecological receptors have a high potential for becoming exposed to contaminants in the surface soil.

The second measurement endpoint is determining if the terrestrial CDI exceeds the TRVs. The cottontail rabbit and the raccoon are the only terrestrial species with estimated CDI values that exceeded the TRV values. However, the COPCs causing the majority of the risk (aluminum, iron,

and/or vanadium) are not related to past site activities, and are common naturally occurring metals. Therefore, they are not considered to be site-related.

Overall, some potential impacts to soil invertebrates and plants may occur as a result of site-related contaminants. It should be noted that there is much uncertainty in the SSSVs. A potential decrease in the terrestrial vertebrate population from site-related contaminants is not expected based on the terrestrial intake model.

7.13 References

Arthur and Alldredge. 1979. Public Health Evaluation and Ecological Assessment. Martin Marrietta Astronautics Group, Waterton Facility, Vol. II of III, Appendix A and B. Cited in Scarano, 1993.

Baes, C.F., Sharp, A.L., and R.W. Shor. September 1984. "Review and Analysis of Parameters for Assessing Transport of Environmentally Released Radionuclides through Agriculture." Oak Ridge National Laboratory.

Beyer, N., E. Connor, and S. Gerould. 1993. "Estimates of Soil Ingestion by Wildlife". Patuxent Wildlife Research Center, Laurel, MD.

Dee, J.C. November, 1991. "Methodology For Assessing Potential Risks To Deer Populations: A Case Study at a Superfund Site". Paper presented at the 1991 Annual Meeting of the Society of Environmental Toxicology and Chemistry. Abstract No. 426.

Fitchko, J. 1989. Criteria for Contaminated Soil/Sediment Cleanup. Pudvan Publishing Company, Northbrook, Illinois.

Long, E.W., D.D. Macdonald, S.L. Smith, and F.D. Calder. 1995. "Incidence of Adverse Biological Effects within Ranges of Chemical Concentrations in Marine and Estuarine Sediments." *Environmental Management* Vol. 19, No.1, pp. 81-97.

Long, E.R and Morgan, L.G. 1991. The Potential for Biological Effects of Sediment-Sorbed Contaminants Tested in the National Status and Trends Program. National Oceanic and Atmospheric Administration Technical Memorandum NOS OMA 52.

Menzie, C.A., Cura J. and J. Freshman. January 1993. Evaluating Ecological Risks and Developing Remedial Objectives at Forested Wetland Systems in New England. Paper contained in: Application of Ecological Risk Assessment To Hazardous Waste Site Remediation. Water Environmental Federation.

Montgomery, J.H. and L.M. Welkon. 1990. Groundwater Chemicals Desk Reference. Lewis Publishers, Inc. Chelsea, Michigan.

Nagy, Kenneth. 1987. "Field Metabolic Rate and Food Requirement Scaling in Mammals and Birds. *Ecological Monographs*." 57(2). pp. 111-128.

NAS. 1992. Subcommittee on Mineral Toxicity in Animals. Mineral Tolerance of Domestic Animals. National Academy of Sciences. Washington, D.C. pp 5-7.

NC DEHNR. 1994. 15A NCAC 2b.0200 - Classifications and Water Quality Standards Applicable to Surface Waters of North Carolina. State of North Carolina Department of Health and Natural Resources. June 1, 1994.

Opresko, D.M., B.E. Sample, and G.W. Suter II. 1994. Toxicological Benchmarks for Wildlife, 1994 Revisions. Prepared for the US Department of Energy, Office of Environmental Restoration and Waste Management. September, 1994. ES/ER/TM-86/R1.

SCDM. 1991. Superfund Chemical Data Matrix. United States Environmental Protection Agency Hazardous Site Evaluation Division. December 1991.

Scarano, Louis, J. Ph.D. and Daniel M. Woltering, Ph.D. January 1993. "Terrestrial and Aquatic Eco-Assessment for A RCRA Hazardous Waste Site". Paper contained in: Application of Ecological Risk Assessment To Hazardous Waste Site Remediation. Cited in WEF, 1993.

Sullivan, J., J. Ball, E. Brick, S. Hausmann, G., G. Pilarski, and D. Sopcich. 1985 Report of the Technical Subcommittee on Determination of Dredge Material Suitability for In-Water Disposal. Wisconsin Department of Natural Resources, Madison, WI. November, 1985.

Suter, G.W. II. and J.B. Mabrey. 1994. Toxicological Benchmarks for Screening Potential Contaminants of Concern for Effects on Aquatic Biota: 1994 Revision. Environmental Sciences Division, Oak Ridge National Laboratory.

Tetra Tech, Inc. 1986. Development of Sediment Quality Values for Puget Sound, Volume I. Puget Sound Dredged Disposal Analysis Report. Cited in Fitchko, 1989.

Travis, Curtis C. and Angela Arms. 1988. Bioconcentration of Organics in Beef, Milk, and Vegetation. Environmental Science Technology. Vol. 22, No. 3.

USEPA, U.S. Environmental Protection Agency. January 26, 1995a. "Toxic Substance Spreadsheet". Region IV, Atlanta, Georgia.

USEPA, U.S. Environmental Protection Agency. January 19, 1995b. "Region III BTAG Screening Levels". Region III, Philadelphia, PA.

USEPA, U.S. Environmental Protection Agency. September 26, 1994a. Ecological Risk Assessment Guidance for Superfund: Process for Designing and Conducting Ecological Risk Assessments. Review Draft Environmental Response Team, Edison NJ

USEPA, U.S. Environmental Protection Agency. June 1994b. Methods for Measuring the Toxicity and Bioaccumulation of Sediment-Associated Contaminants with Freshwater Invertebrates. Office of Research and Development, Washington, DC. EPA/600/R-94/024.

USEPA, U.S. Environmental Protection Agency. September 1993a. Technical Basis for Deriving Sediment Quality Criteria for Nonionic Organic Contaminants for the Protection of Benthic Organisms by using Equilibrium Partitioning. Office of Science and Technology, Health and Ecological Criteria Division. EPA-822-R-93-011.

USEPA, U.S. Environmental Protection Agency. 1993b. "Water Quality Guidance for the Great Lakes System and Correction: Proposed Rules". Federal Register. 58(72) 20802-21047. Cited in Suter and Mabrey, 1994.

USEPA, U.S. Environmental Protection Agency. September 1993c. Sediment Quality Criteria for the Protection of Benthic Organisms: Fluoranthene. Office of Science and Technology, Health and Ecological Criteria Division. EPA-822-R-93-012.

USEPA, U.S. Environmental Protection Agency. September 1993d. Sediment Quality Criteria for the Protection of Benthic Organisms: Phenanthrene. Office of Science and Technology, Health and Ecological Criteria Division. EPA-822-R-93-014.

USEPA, U.S. Environmental Protection Agency. December 1993e. Wildlife Exposure Factors Handbook. Office of Research and Development. Washington, D.C. EPA/600/R-93/187a.

USEPA, U.S. Environmental Protection Agency. October 1, 1993f. Office of Water Policy and Technical Guidance on Interpretation and Implementation of Aquatic Life Metals Criteria. Office of Water.

USEPA. U.S. Environmental Protection Agency. February 1992. Framework for Ecological Risk Assessment. United States Environmental Protection Agency. Risk Assessment Forum. EPA/630/R-92/001.

USEPA, U.S. Environmental Protection Agency. June 1991a. National Functional Guidelines for Organic Data Review. Draft. USEPA Contract Laboratory Program.

USEPA, U.S. Environmental Protection Agency. May 1, 1991b. "Water Quality Criteria Summary" (Wall Chart). Office of Science and Technology. Health and Ecological Criteria Section. Washington, D.C.

USEPA, U.S. Environmental Protection Agency. March 1990. Methods for Measuring the Acute Toxicity of Effluents to Freshwater and Marine Organisms. Fourth Edition, Environmental Monitoring Systems Laboratory, Cincinnati, OH. EPA/600/4-90/027F.

USEPA. U.S. Environmental Protection Agency. December 1989a. Risk Assessment Guidance for Superfund, Volume I. Human Health Evaluation Manual (Part A). Interim Final EPA

USEPA. U.S. Environmental Protection Agency. March 1989b. Risk Assessment Guidance for Superfund Volume II. Environmental Evaluation Manual Interim Final. Office of Solid Waste and Emergency Response. Washington, D.C. EPA/540/1-89-001.

USEPA. U.S. Environmental Protection Agency. March 1989c. Ecological Assessment of Hazardous Waste Sites: A Field and Laboratory Reference. Environmental Research Laboratory, Corvallis, OR. EPA/600/3-89/013.

USEPA, U.S. Environmental Protection Agency. 1989d. Short-Term Methods for Estimating the Chronic Toxicity of Effluents and Receiving Waters to Freshwater Organisms. Second Edition, Environmental Monitoring Systems Laboratory, Cincinnati, OH. EPA/600/4-89/001 March 1989.

USEPA. U.S. Environmental Protection Agency. May 1987. Quality Criteria for Water-1986. Office of Water Regulations.

USEPA. U.S. Environmental Protection Agency. October 1986. Chemical, Physical, and Biological Properties of Compounds Present at Hazardous Waste Sites. Office of Solid Waste and Remedial Response. Washington D.C. EPA/540/1-86/060.

Water Environment Federation (WEF). 1989. Application of Ecological Risk Assessment to Hazardous Waste Site Remediation. Based on a January 10, 1993 Workshop., 601 Wythe Street, Alexandria, VA 22314-1994.

Will, M.E. and Suter, G.W. II. 1994a. Toxicological Benchmarks for Screening Potential Contaminants of Concern for Effects on Soil and Litter Invertebrates and Heterotrophic Process. Environmental Sciences Division, Oak Ridge National Laboratory.

Will, M.E. and Suter, G.W. II. 1994b. Toxicological Benchmarks for Screening Potential Contaminants of Concern for Effects on Terrestrial Plants. Environmental Sciences Division, Oak Ridge National Laboratory.

SECTION 7.0 TABLES

TABLE 7-1

**FREQUENCY AND RANGE OF CONTAMINANT DETECTIONS
 COMPARED TO SALTWATER SURFACE WATER SCREENING VALUES
 SITE 44, JONES STREET DUMP
 REMEDIAL INVESTIGATION CTO-0303
 MCAS, NEW RIVER, NORTH CAROLINA**

Contaminant	Surface Water Screening Values (SWSV)			Average Reference Station Concentration	Contaminant Frequency/Range		No. of Positive Detects Above Lowest SWSV	No. of Positive Detects Above the Average Reference Station Concentration
	North Carolina Water Quality Standards (WQS) ⁽¹⁾	USEPA Region IV Water Quality Screening Values (WQSV) ⁽²⁾			No. of Positive Detects/No. of Samples	Range of Positive Detection		
		Acute	Chronic					
Volatiles (µg/L)								
Acetone	NE	NE	NE	ND	3/16	10-13	NA	3
1,1-Dichloroethene	712,000	NE	NE	ND	3/16	1J-2J	0	1
1,2-Dichloroethene (total)	NE	224,000 ⁽³⁾	NE	ND	14/16	2J-150	0	6
1,1,2,2-Tetrachloroethane	NE	9,020 ⁽⁴⁾	NE	ND	12/16	5-42	0	5
1,1,2-Trichloroethane	NE	NE	NE	ND	1/16	1J	NA	1
Trichloroethene	NE	2,000 ⁽³⁾	NE	ND	14/16	2J-66	0	6
Vinyl chloride	NE	224,000 ⁽³⁾	NE	ND	8/16	7J-38	0	3
Semivolatiles (µg/L)								
Bis(2-ethylhexyl)phthlate	NE	NE	360 ⁽³⁾	ND	6/8	1J-3J	0	6
Phenol	NE	5,800 ⁽³⁾	NE	ND	1/8	1J	0	1
Inorganics (µg/L)								
Aluminum	NE	NE	NE	333	7/8	122-509	NA	3
Barium	NE	NE	NE	25.67	7/8	14.5-27.1	NA	2
Calcium	NE	NE	NE	17,567	8/8	33,500-55,500	NA	8
Copper	3	2.9	2.9	ND	7/8	1.9-2.3	0	7
Iron	NE	NE	NE	576	8/8	1,170-1,980	NA	8

TABLE 7-1 (Continued)

FREQUENCY AND RANGE OF CONTAMINANT DETECTIONS
 COMPARED TO SALTWATER SURFACE WATER SCREENING VALUES
 SITE 44, JONES STREET DUMP
 REMEDIAL INVESTIGATION CTO-0303
 MCAS, NEW RIVER, NORTH CAROLINA

Contaminant	Surface Water Screening Values (SWSV)			Average Reference Station Concentration	Contaminant Frequency/Range		No. of Positive Detects Above Lowest SWSV	No. of Positive Detects Above the Average Reference Station Concentration
	North Carolina Water Quality Standards (WQS) ⁽¹⁾	USEPA Region IV Water Quality Screening Values (WQSV) ⁽²⁾			No. of Positive Detects/No. of Samples	Range of Positive Detection		
		Acute	Chronic					
Lead	25	220	8.5	ND	2/8	0.83J-11.2	1	2
Magnesium	NE	NE	NE	1,745	8/8	2,530-23,300	NA	8
Manganese	NE	NE	10 ⁽³⁾	ND	8/8	38.8-231	8	8
Nickel	8.3	75	8.3	ND	3/8	7.7-21.1	2	3
Potassium	NE	NE	NE	ND	8/8	3,390-10,000	NA	8
Sodium	NE	NE	NE	9,830	8/8	16,200-195,000	NA	8
Vanadium	NE	NE	10,000 ⁽³⁾	ND	4/8	11.7-29.9	0	4
Zinc	86	95	86	ND	7/8	16.8J-61.3J	0	7

Notes:

- NE = Not Established
- NA = Not Applicable
- ND = Not Detected

- ⁽¹⁾ NCDEHNR, 1994 (North Carolina Water Quality Standards)
- ⁽²⁾ USEPA, 1995a (Region IV Toxic Substance Spreadsheet)
- ⁽³⁾ USEPA, 1995b (Region III BTAG Screening Levels)
- ⁽⁴⁾ USEPA, 1991b (Wall Chart, Lowest Observed Effect Concentration)

TABLE 7-2

FREQUENCY AND RANGE OF DISSOLVED INORGANIC DETECTIONS
 COMPARED TO SALTWATER SURFACE WATER SCREENING VALUES
 SITE 44, JONES STREET DUMP
 REMEDIAL INVESTIGATION CTO-0303
 MCAS, NEW RIVER, NORTH CAROLINA

Contaminant	Surface Water Screening Values (SWSV)			Contaminant Frequency/Range		No. of Positive Detects Above Lowest SWSV
	North Carolina Water Quality Standards (WQS) ⁽¹⁾	USEPA Region IV Water Quality Screening Values (WQSV) ⁽²⁾		No. of Positive Detects/No. of Samples	Range of Positive Detection	
		Acute	Chronic			
Inorganics (µg/L)						
Aluminum	NE	NE	NE	3/8	21.9-25.9	NA
Barium	NE	NE	NE	7/8	12.7-22.4	NA
Calcium	NE	NE	NE	8/8	33,200-55,500	NA
Copper	3	2.9	2.9	4/8	1.9-3.7	2
Iron	NE	NE	NE	8/8	268-654J	NA
Lead	25	220	8.5	1/8	41.8	1
Magnesium	NE	NE	NE	8/8	2,470-24,400	NA
Manganese	NE	NE	10 ⁽³⁾	8/8	6.5-33.3	7
Nickel	8.3	75	8.3	3/8	6.2-19.8	2
Potassium	NE	NE	NE	8/8	3,420-10,300	NA
Sodium	NE	NE	NE	8/8	16,000-205,000	NA
Vanadium	NE	NE	10,000 ⁽³⁾	2/8	2.5-11.6	0
Zinc	86	95	86	7/8	6J-24.3	0

Notes:

NE = Not Established

NA = Not Applicable

⁽¹⁾ NCDEHNR, 1994 (North Carolina Water Quality Standards)

⁽²⁾ USEPA, 1995a (Region IV Toxic Substance Spreadsheet)

⁽³⁾ USEPA, 1995b (Region III BTAG Screening Levels)

TABLE 7-3

**FREQUENCY AND RANGE OF CONTAMINANT DETECTIONS
 COMPARED TO SALTWATER SEDIMENT SCREENING VALUES
 SITE 44, JONES STREET DUMP
 REMEDIAL INVESTIGATION CTO-0303
 MCAS, NEW RIVER, NORTH CAROLINA**

Contaminant	Sediment Screening Values (SSV)			Average Reference Station Concentration (upstream)	Contaminant Frequency/Range		No. of Positive Detects Above Lowest SSV	No. of Positive Detect Above the Average Reference Concentration
	ER-L	ER-M	SQC ⁽³⁾		Range of Positive Detects	No. of Positive Detects/No. of Samples		
Volatiles (µg/kg)								
Acetone	NE	NE	NE	ND	15-610J	10/16	NA	10
2-Butanone	NE	NE	NE	ND	51-200	2/16	NA	2
Semivolatiles (µg/kg)								
Benzo(a)anthracene	261 ⁽¹⁾	1,600 ⁽¹⁾	14,585	ND	50J-170J	3/16	0	3
Benzo(a)pyrene	430 ⁽¹⁾	1,600 ⁽¹⁾	1,502	ND	56J-300J	3/16	0	3
Benzo(b)fluoranthene	3,200 ⁽⁴⁾	NE	214,500	ND	52J-600	6/16	0	6
Benzo(k)fluoranthene	3,700 ⁽⁵⁾	NE	214,500	ND	49J-200J	3/16	0	3
Benzo(g,h,i)perylene	670 ⁽⁴⁾	NE	624,000	ND	49J-71J	2/16	0	2
Bis(2-ethylhexyl)phthalate	1,900 ⁽⁵⁾	NE	46,800	ND	530-870	4/16	0	4
Butylbenzylphthalate	63 ⁽⁵⁾	NE	0.3	ND	48J	1/16	1	1
Carbazole	NE	NE	NE	ND	79J	1/16	NA	1
Chrysene	384 ⁽¹⁾	2,800 ⁽¹⁾	78,000	ND	44J-460	7/16	1	7
Fluoranthene	600 ⁽¹⁾	5,100 ⁽¹⁾	801	ND	95J-740	6/16	1	6
Pentachlorophenol	360 ⁽⁴⁾	NE	544	ND	340J-740J	2/16	1	2
Phenanthrene	240 ⁽¹⁾	1,500 ⁽¹⁾	237	ND	49J-250	5/16	1	5
Pyrene	665 ⁽¹⁾	2,600 ⁽¹⁾	14,820	ND	42J-490	7/16	0	7
Pesticides (µg/kg)								
Aldrin	10 ⁽⁶⁾	NE	0.37	1.05	2.6J	1/14	1	1
4,4'-DDD	2 ⁽²⁾	20 ⁽²⁾	1.00	1.57	5.5J-770	16/16	16	16
4,4'-DDE	2.2 ⁽¹⁾	27 ⁽¹⁾	5.72	2.42	9.3J-810J	16/16	16	16

TABLE 7-3 (Continued)

FREQUENCY AND RANGE OF CONTAMINANT DETECTIONS
 COMPARED TO SALTWATER SEDIMENT SCREENING VALUES
 SITE 44, JONES STREET DUMP
 REMEDIAL INVESTIGATION CTO-0303
 MCAS, NEW RIVER, NORTH CAROLINA

Contaminant	Sediment Screening Values (SSV)			Average Reference Station Concentration (upstream)	Contaminant Frequency/Range		No. of Positive Detects Above Lowest SSV	No. of Positive Detect Above the Average Reference Concentration
	ER-L	ER-M	SQC ⁽³⁾		Range of Positive Detections	No. of Positive Detects/No. of Samples		
4,4'-DDT	1 ⁽²⁾	7 ⁽²⁾	0.32	2.20	2.5J-130	10/14	10	10
Alpha-chlordane	0.5 ⁽²⁾	6 ⁽²⁾	0.73	1.20	2-14J	13/16	13	13
Gamma-chlordane	0.5 ⁽²⁾	6 ⁽²⁾	0.73	1.44	2.7J-16J	13/16	13	13
Heptachlor epoxide	NE	NE	0.001	ND	5.2J	1/14	1	1
Inorganics (mg/kg)								
Aluminum	NE	NE	NE	1,166	556J-12,200J	16/16	NA	7
Arsenic	8.2 ⁽¹⁾	70 ⁽¹⁾	NE	0.37	0.34-1.4	11/16	0	9
Barium	500 ⁽⁶⁾	NE	NE	6.46	4.9-49.5	16/16	0	11
Beryllium	0.5 ⁽⁵⁾	NE	NE	0.09	0.11-0.17	2/16	0	2
Cadmium	1.2 ⁽¹⁾	9.6 ⁽¹⁾	NE	0.04	1.2	1/16	0	1
Calcium	NE	NE	NE	1,967	2,610-40,000	16/16	NA	16
Chromium	81 ⁽¹⁾	370 ⁽¹⁾	NE	1.86	2.6-11.1	16/16	0	16
Cobalt	NE	NE	NE	ND	0.48	1/16	NA	1
Copper	34 ⁽¹⁾	270 ⁽¹⁾	NE	0.75	1.9-7.7	16/16	0	16
Iron	27,000 ⁽⁵⁾	NE	NE	434	613-5,830	16/16	0	16
Lead	46.7 ⁽¹⁾	218 ⁽¹⁾	NE	0.79	8.4J-56.3J	16/16	2	16
Magnesium	NE	NE	NE	45.25	95.8-637	16/16	NA	16
Manganese	230 ⁽⁵⁾	NE	NE	3.63	2-15.9	16/16	0	11
Nickel	20.9 ⁽¹⁾	51.6 ⁽¹⁾	NE	ND	1.1-4	15/16	0	15
Potassium	NE	NE	NE	ND	60.2-299	5/16	NA	5

TABLE 7-3 (Continued)

FREQUENCY AND RANGE OF CONTAMINANT DETECTIONS
 COMPARED TO SALTWATER SEDIMENT SCREENING VALUES
 SITE 44, JONES STREET DUMP
 REMEDIAL INVESTIGATION CTO-0303
 MCAS, NEW RIVER, NORTH CAROLINA

Contaminant	Sediment Screening Values (SSV)			Average Reference Station Concentration (upstream)	Contaminant Frequency/Range		No. of Positive Detects Above Lowest SSV	No. of Positive Detect Above the Average Reference Concentration
	ER-L	ER-M	SQC ⁽³⁾		Range of Positive Detects	No. of Positive Detects/No. of Samples		
Selenium	1.0 ⁽⁵⁾	NE	NE	0.19	0.47-1.4	4/16	1	4
Silver	1.0 ⁽¹⁾	3.7 ⁽¹⁾	NE	0.25	0.51	1/16	0	1
Sodium	NE	NE	NE	ND	30.3-224	16/16	NA	16
Vanadium	NE	NE	NE	1.52	1.9-15.1	16/16	NA	16
Zinc	150 ⁽¹⁾	410 ⁽¹⁾	NE	5.11	6.3-144	16/16	0	16

Notes:

- NE = Not Established
- NA = Not Applicable
- ER-L = Effects Range Low
- ER-M = Effects Range Median
- SQC = Sediment Quality Criteria

⁽¹⁾ Long et.al., 1995

⁽²⁾ Long and Morgan, 1991

⁽³⁾ Values were calculated using the following equation: $SQC = Foc * Koc * FCV / 1000000$

Where:

Foc = Fraction of organic carbon in the sediments (used 1,300 mg/kg)

Koc = Organic carbon partition coefficient (chemical specific)

FCV = Final water chronic value (chemical specific)

⁽⁴⁾ USEPA, 1995a (Region III BTAG Screening Levels)

⁽⁵⁾ Tetra Tech Inc., 1986 (Apparent Effects Threshold Sediment Quality Values)

⁽⁶⁾ Sullivan et.al., 1985

TABLE 7-4

**CONTAMINANTS OF POTENTIAL CONCERN IN EACH MEDIA
SITE 44, JONES STREET DUMP
REMEDIAL INVESTIGATION CTO-0303
MCAS, NEW RIVER, NORTH CAROLINA**

Contaminant	Surface Water		Sediment	Surface Soil
	Aquatic receptors	Terrestrial receptors		
Volatiles				
Acetone	X	X	X	X
2-Butanone			X	
1,1-Dichloroethene		X		
1,2-Dichloroethene		X		
1,1,2,2-Tetrachloroethane		X		
1,1,2-Trichloroethane	X	X		
Trichloroethene		X		
Vinyl chloride		X		
Semivolatiles				
Benzo(g,h,i)perylene				X
Bis(2-chloroethyl)ether				X
Bis(2-ethylhexyl)phthalate		X		X
Butylbenzylphthalate			X	
Carbazole			X	
Chrysene			X	
2,6-Dinitrotoluene				X
Fluoranthene			X	
Indeno(1,2,3-cd)pyrene				X
Pentachlorophenol			X	
Phenanthrene			X	
Phenol		X		
Pesticides/PCBs				
Aldrin			X	
Alpha-chlordane			X	
Gamma-chlordane			X	
4,4'-DDE			X	X
4,4'-DDD			X	X
4,4'-DDT			X	X
Heptachlor epoxide			X	

TABLE 7-4 (Continued)

CONTAMINANTS OF POTENTIAL CONCERN IN EACH MEDIA
 SITE 44, JONES STREET DUMP
 REMEDIAL INVESTIGATION CTO-0303
 MCAS, NEW RIVER, NORTH CAROLINA

Contaminant	Surface Water		Sediment	Surface Soil
	Aquatic receptors	Terrestrial receptors		
Inorganics				
Aluminum	X	X	X	X
Arsenic				X
Barium	X	X		X
Chromium				X
Cobalt			X	
Copper	X	X		X
Iron	X	X		X
Lead	X	X	X	X
Manganese	X	X		X
Nickel	X	X		
Selenium			X	
Vanadium		X	X	X
Zinc		X		X

TABLE 7-5

**PHYSICAL/CHEMICAL CHARACTERISTICS OF THE COPCS
SITE 44, JONES STREET DUMP
REMEDIAL INVESTIGATION CTO-0303
MCAS, NEW RIVER, NORTH CAROLINA**

Contaminant of Potential Concern	BCF	Organic Carbon Partition Coefficient (mL/g)	Log Octanol/Water Coefficient	Biotransfer Factors		
				Bv ⁽¹⁾⁽²⁾	Br ⁽¹⁾⁽²⁾	Bb ⁽¹⁾⁽²⁾
Volatiles						
Acetone	0.69 ⁽⁴⁾	2.2 ⁽⁵⁾	-0.24 ⁽⁶⁾	5.30e+01	5.30e+01	1.45e-08
2-Butanone	ND	4.5 ⁽⁵⁾	0.29 ⁽⁶⁾	-4.01e-04	-4.01e-04	-1.38e+07
1,1-Dichloroethene	5.6 ⁽³⁾	65 ⁽⁵⁾	2.1 ⁽⁶⁾	2.37e+00	2.37e+00	3.16e-06
1,2-Dichloroethene	5.6 ⁽³⁾	54 ⁽⁵⁾	2 ⁽⁶⁾	2.70e+00	2.70e+00	2.51e-06
1,1,2,2-Tetrachloroethane	5 ⁽⁴⁾	152 ⁽⁵⁾	3 ⁽⁶⁾	7.14e-01	7.14e-01	2.51e-05
1,1,2-Trichloroethane	4.5 ⁽³⁾	56 ⁽⁵⁾	2.2 ⁽⁶⁾	2.07e+00	2.07e+00	3.98e-06
Trichloroethene	10.6 ⁽⁴⁾	126 ⁽⁵⁾	2.4 ⁽⁶⁾	2.07e+00	2.07e+00	3.98e-06
Vinyl chloride	1.17 ⁽⁴⁾	57 ⁽⁵⁾	1.4 ⁽⁶⁾	6.01e+00	6.01e+00	6.31e-07
Semivolatiles						
Benzo(g,h,i)perylene	30 ⁽³⁾	1,600,000 ⁽⁵⁾	6.5 ⁽⁵⁾	7.00e-03	7.00e-03	7.94e-02
Bis(2-chloroethyl)ether	6.9 ⁽⁴⁾	13.9 ⁽⁵⁾	1.3 ⁽⁶⁾	6.86e+00	6.86e+00	5.01e-07
Bis(2-ethylhexyl)phthalate	130 ⁽³⁾	100,000 ⁽⁷⁾	5.1 ⁽⁶⁾	4.40e-02	4.40e-02	3.16e-03
Butylbenzylphthalate	414 ⁽³⁾	67.6 ⁽⁷⁾	4.9 ⁽⁶⁾	5.70e-02	5.70e-02	2.00e-03
Carbazole	ND	ND	6 ⁽⁸⁾	1.30e-02	1.30e-02	2.51e-02
Chrysene	30 ⁽³⁾	200,000 ⁽⁵⁾	5.7 ⁽⁶⁾	2.00e-02	2.00e-02	1.26e-02
2,6-Dinitrotoluene	ND	92 ⁽⁵⁾	2.1 ⁽⁶⁾	2.37e+00	2.37e+00	3.16e-06
Fluoranthene	1,150 ⁽³⁾	100,000 ⁽⁹⁾	5.1 ⁽⁹⁾	4.40e-02	4.40e-02	3.90e-03
Indeno(1,2,3-cd)pyrene	30 ⁽³⁾	1,600,000 ⁽⁵⁾	6.5 ⁽⁶⁾	7.00e-03	7.00e-03	8.13e-02
Pentachlorophenol	11 ⁽⁴⁾	53,000 ⁽⁵⁾	5.9 ⁽¹⁾	1.51e-02	1.51e-02	2.00e-02
Phenanthrene	30 ⁽³⁾	28,840 ⁽¹⁰⁾	4.5 ⁽¹⁰⁾	9.70e-02	9.70e-02	7.94e-04
Phenol	1.4 ⁽⁴⁾	14 ⁽⁵⁾	1.5 ⁽⁶⁾	5.26e+00	5.26e+00	7.94e-07
Pesticides/PCBs						
Aldrin	4,670 ⁽³⁾	96,000 ⁽⁵⁾	3 ⁽⁶⁾	7.14e-01	7.14e-01	2.51e-05
Alpha-chlordane	14,100 ⁽³⁾	140,000 ⁽⁵⁾	5.5 ⁽⁶⁾	2.60e-02	2.60e-02	7.94e-03
Gamma-chlordane	14,100 ⁽³⁾	140,000 ⁽⁵⁾	5.5 ⁽⁶⁾	2.60e-02	2.60e-02	7.94e-03
4,4'-DDD	53,600 ⁽³⁾	770,000 ⁽⁵⁾	6 ⁽⁶⁾	1.32e-02	1.32e-02	2.51e-02
4,4'-DDE	53,600 ⁽³⁾	4,400,000 ⁽⁵⁾	5.7 ⁽⁶⁾	2.00e-02	2.00e-02	1.26e-02
4,4'-DDT	53,600 ⁽³⁾	243,000 ⁽⁵⁾	6.4 ⁽⁶⁾	8.00e-03	8.00e-03	6.31e-02
Heptachlor epoxide	11,200 ⁽³⁾	220 ⁽⁵⁾	4.3 ⁽⁶⁾	1.27e-01	1.27e-01	5.01e-04
Inorganics						
Aluminum	231 ⁽⁴⁾	ND	ND	4.00e-03	6.50e-04	1.50e-03
Arsenic	44 ⁽³⁾	ND	ND	4.00e-02	6.00e-03	2.00e-03
Barium	8 ⁽⁴⁾	ND	ND	1.50e-01	1.50e-02	1.50e-04
Chromium	16 ⁽³⁾	ND	ND	7.50e-03	4.50e-03	5.50e-03

TABLE 7-5 (Continued)

PHYSICAL/CHEMICAL CHARACTERISTICS OF THE COPCS
 SITE 44, JONES STREET DUMP
 REMEDIAL INVESTIGATION CTO-0303
 MCAS, NEW RIVER, NORTH CAROLINA

Contaminant of Potential Concern	BCF	Organic Carbon Partition Coefficient (mL/g)	Log Octanol/Water Coefficient	Biotransfer Factors		
				Bv ⁽¹⁾⁽²⁾	Br ⁽¹⁾⁽²⁾	Bb ⁽¹⁾⁽²⁾
Cobalt	40 ⁽⁴⁾	ND	ND	2.00e-02	7.00e-03	2.00e-02
Copper	36 ⁽³⁾	ND	ND	4.00e-01	2.50e-01	1.00e-02
Iron	ND	ND	ND	4.00e-03	1.00e-03	2.00e-02
Lead	49 ⁽³⁾	ND	ND	4.50e-02	9.00e-03	3.00e-04
Manganese	35 ⁽⁴⁾	ND	ND	2.50e-01	5.00e-02	4.00e-04
Nickel	47 ⁽³⁾	ND	ND	6.00e-02	6.00e-02	6.00e-03
Selenium	6 ⁽³⁾	ND	ND	2.50e-02	2.50e-02	1.50e-02
Vanadium	ND	ND	ND	5.50e-03	3.00e-03	2.50e-03
Zinc	47 ⁽³⁾	ND	ND	1.50e+00	9.00e-01	1.00e-01

Notes:

- (1) Baes, 1984 for the inorganics
- (2) The organics were calculated using Travis, 1988
- (3) USEPA, 1995a (Region IV)
- (4) USEPA, 1995b (Region III)
- (5) USEPA, 1986.
- (6) SCDM, 1991.
- (7) Montgomery and Welkon, 1990.
- (8) Used benzo(a)pyrene Kow
- (9) USEPA, 1993c (Sediment Quality Criteria for Fluoranthene)
- (10) USEPA, 1993d (Sediment Quality Criteria for Phenanthrene)

BCF = Bioconcentration Factor

ND = No Data

Bv = Biotransfer factor for vegetation (stems, leaves)

Br = Biotransfer factor for vegetation (berries, fruits)

Bb = Biotransfer factor for beef

TABLE 7-6

SAMPLING STATION CHARACTERIZATION SUMMARY
 SITE 44, JONES STREET DUMP
 REMEDIAL INVESTIGATION CTO-0303
 MCAS, NEW RIVER, NORTH CAROLINA

Station	Stream Width (ft)	Stream Depth (ft)	Canopy Cover	Sediment Description	Sediment Odor
44-EC-SW/SD01	10	1-2	Partly Shaded	Coarse sand/gravel (black/gray)	Normal
44-EC-SW/SD02	5	0.5	Shaded	brown sand (0.5 inch), rest coarse sand/gravel (black/gray), some sticks/twigs at 10 inches	Slight Anaerobic
44-EC-SW/SD03	10	0.5	Partly Shaded	Coarse sand (black/gray)	Slight Anaerobic
44-EC-SW/SD04	15	1	Shaded	Coarse sand (black/gray)	Slight Petroleum (at 6 inches)
44-EC-SW/SD05	20	1-2	Shaded	Silty sand (black/brown)	Petroleum (at 6-12 inches)
44-UT-SW/SD01	3-4	0.5	Partly Shaded	Silty sand, refusal at 8 inches	Normal
44-UT-SW/SD02	15-20	0.5	Partly Shaded	Coarse sand at 6 inches (black/gray), fine silt/sand at 6-12 inches (brown)	Petroleum (at 4-6 inches)
44-UT-SW/SD03	10-15	1.5	Shaded	Medium/fine sand with some silt (gray/black) and some organic debris	Anaerobic

Notes:

- SW = Surface Water Sample
- SD = Sediment Sample
- EC = Edwards Creek
- UT = Unnamed Tributary to Edwards Creek

TABLE 7-7

FIELD CHEMISTRY DATA
 SITE 44, JONES STREET DUMP
 REMEDIAL INVESTIGATION CTO-0303
 MCAS, NEW RIVER, NORTH CAROLINA

Station	Temperature (°C)	pH (S.U.)	Dissolved Oxygen (mg/L)	Conductivity (umhos/cm)	Salinity (ppt)
44-EC-SW/SD01	18.1	3.58	2.9	6.84	0
44-EC-SW/SD02	16.4-18.4	6.57-7.14	2.6-6.9	350-441	0
44-EC-SW/SD03	13.0-15.8	6.92	3.0	320-354	0.1
44-EC-SW/SD04	16.0-16.5	7.08	3.2	909-950	0.8-0.9
44-EC-SW/SD05	17.7-18.5	7.16-7.32	4.3-5.1	950-5,400	0.9-4.1
44-UT-SW/SD01	16.3-16.6	6.87	3.0	425-511	0.1
44-UT-SW/SD02	15.5-15.9	6.93	8.2	509-850	0.2-1
44-UT-SW/SD03	15.5-16.5	6.78-6.93	0.7-1.7	750-2,020	0.5-2.1

Notes:

°C = Degrees Centigrade
 mg/L = Milligrams per Liter
 S.U. = Standard Units
 umhos/cm = Micromhos per centimeter
 ppt = Parts Per Thousand

TABLE 7-8

**FREQUENCY AND RANGE OF CONTAMINANT DETECTIONS
 COMPARED TO SOIL FLORA AND FAUNA SCREENING VALUES
 SITE 44, JONES STREET DUMP
 REMEDIAL INVESTIGATION CTO-0303
 MCAS, NEW RIVER, NORTH CAROLINA**

Contaminant	Soil Flora and Fauna Screening Values ^(a)				Contaminant Frequency/Range		No. of Positive Detects Above Lowest Screening Value
	Plant	Earthworm	Invertebrate	Microorganisms and Microbial Processes	No. of Positive Detects/No. of Samples	Range of Positive Detections	
Volatiles (µg/kg)							
Acetone	NE	NE	NE	NE	1/13	13J	NA
Semivolatiles (µg/kg)							
Benzo(g,h,i)perylene	NE	100 ^(a)	100 ^(a)	NE	2/13	57J-200J	1
Bis(2-chloroethyl)ether	NE	NE	NE	NE	1/13	550J	NA
Bis(2-ethylhexyl)phthalate	1,000	NE	NE	NE	1/13	260J	0
2,6-Dinitrotoluene	NE	NE	NE	NE	1/13	380J	NA
Indeno(1,2,3-cd)pyrene	NE	100 ^(a)	100 ^(a)	NE	1/13	220J	1
Pesticides (µg/kg)							
4',4-DDD	NE	100 ^(a)	100 ^(a)	NE	1/13	7.4J	0
4',4-DDE	NE	100 ^(a)	100 ^(a)	NE	4/13	10J-140	1
4',4-DDT	NE	4 ^(a)	4 ^(a)	NE	4/13	4.6J-45J	4
Inorganics (mg/kg)							
Aluminum	50	NE	NE	600	13/13	3,520-14,100	13
Arsenic	10	60	NE	100	13/13	0.79J-4.9J	0
Barium	500	440 ^(a)	440 ^(a)	3,000	13/13	8.3-26.2	0
Chromium	1	0.4	0.0075 ^(a)	10	12/13	4.2-16.4	12
Copper	100	50	20	100	12/13	0.86-910	1
Iron	100 ^(a)	NE	3,515	200	13/13	2,430J-15,400	13
Lead	50	500	300	900	11/13	5.9-31.7J	0
Manganese	500	330 ^(a)	330 ^(a)	100	13/13	4.9-44.2	0

TABLE 7-8 (Continued)

FREQUENCY AND RANGE OF CONTAMINANT DETECTIONS
 COMPARED TO SOIL FLORA AND FAUNA SCREENING VALUES
 SITE 44, JONES STREET DUMP
 REMEDIAL INVESTIGATION CTO-0303
 MCAS, NEW RIVER, NORTH CAROLINA

Contaminant	Soil Flora and Fauna Screening Values ⁽¹⁾				Contaminant Frequency/Range		No. of Positive Detects Above Lowest Screening Value
	Plant	Earthworm	Invertebrate	Microorganisms and Microbial Processes	No. of Positive Detects/No. of Samples	Range of Positive Detections	
Vanadium	2	58 ⁽²⁾	58 ⁽²⁾	20	13/13	7-28.6	13
Zinc	50	200	500	100	13/13	2.7-156	1

Notes:

- (1) Will and Suter (1994a and 1994b) unless indicated otherwise (Values presented for plants, earthworms, and microorganisms and microbial processes are benchmarks below which adverse impacts to these species are not expected. Values for invertebrates are No Observed Effects Concentrations, however, they are based on less data than the benchmarks)
- (2) USEPA, 1995b (Region III BTAG Soil Screening Values for Soil Fauna)

TABLE 7-9

EXPOSURE PARAMETERS FOR CHRONIC DAILY INTAKE MODEL
 SITE 44, JONES STREET DUMP
 REMEDIAL INVESTIGATION CTO-0303
 MCAS, NEW RIVER, NORTH CAROLINA

Exposure Parameter	Units	White-Tailed Deer	Eastern Cottontail Rabbit	Bobwhite Quail	Red Fox	Raccoon	Small Mammal (Meadow Vole)
Food Source Ingestion	NA	Vegetation 100%	Vegetation 100%	Vegetation 100%	Small Mammals 80% Vegetation 20%	Vegetation 40% Fish 60%	Vegetation 100%
Feeding Rate	kg/day	1.6 ⁽²⁾	0.237 ⁽⁴⁾	0.0135 ⁽³⁾	0.601 ⁽³⁾	0.214 ⁽⁶⁾	0.112 ⁽³⁾
Incident Soil Ingestion	kg/day	0.0185 ⁽¹⁾	0.0057 ⁽⁵⁾	0.0011 ⁽⁵⁾	0.0168 ⁽⁵⁾	0.0201 ⁽⁵⁾	0.00269 ⁽⁵⁾
Rate of Drinking Water Ingestion	L/day	1.1 ⁽²⁾	0.119 ⁽³⁾	0.0191 ⁽³⁾	0.385 ⁽³⁾	0.422 ⁽³⁾	0.0652 ⁽³⁾
Rate of Vegetation Ingestion	kg/day	1.6	0.237	0.0135	0.12	0.086	0.112
Body Weight	kg	45.4 ⁽²⁾	1.229 ⁽³⁾	0.174 ⁽³⁾	4.54 ⁽³⁾	5.12 ⁽³⁾	0.3725 ⁽³⁾
Rate of Small Mammal Ingestion	kg/day	NA	NA	NA	0.48	NA	NA
Rate of Fish Ingestion	kg/day	NA	NA	NA	NA	0.128	NA
Home Range Size	acres	454 ⁽²⁾	9.30 ⁽³⁾	26.24 ⁽³⁾	1,245 ⁽³⁾	257 ⁽³⁾	0.032 ⁽³⁾

Notes:

- NA = Not Applicable
⁽¹⁾ Arthur and Alldridge, 1979
⁽²⁾ Dee, 1991
⁽³⁾ USEPA, 1993e
⁽⁴⁾ Opresko, *et.al.*, 1994
⁽⁵⁾ Beyer, 1993
⁽⁶⁾ Nagy, 1987

TABLE 7-10

SURFACE WATER QUOTIENT INDEX
 SITE 44, JONES STREET DUMP
 REMEDIAL INVESTIGATION CTO-0303
 MCAS, NEW RIVER, NORTH CAROLINA

Contaminant	Station	Sample Concentration (µg/L)	Quotient Index		
			North Carolina	USEPA SWSV	
			WQS	Acute	Chronic
Total Inorganics					
Lead	44-EC-SW03	11.2	0.4	0.1	1.3
Manganese	44-EC-SW01	231	NA	NA	23.1
	44-EC-SW02	74.9	NA	NA	7.5
	44-EC-SW03	74.7	NA	NA	7.5
	44-EC-SW04	89.8	NA	NA	9.0
	44-EC-SW05	80	NA	NA	8.0
	44-UT-SW01	47.2	NA	NA	4.7
	44-UT-SW02	38.8	NA	NA	3.9
Nickel	44-UT-SW03	74.2	NA	NA	7.4
	44-EC-SW01	21.1	2.5	0.3	2.5
	44-EC-SW02	15.3	1.8	0.2	1.8
Dissolved Inorganics					
Copper	44-UT-DSW02	3.7	1.2	1.3	1.3
	44-UT-DSW03	3	1.0	1.03	1.03
Lead	44-UT-DSW02	41.8	1.7	0.2	4.9
Manganese	44-EC-DSW01	11	NA	NA	1.1
	44-EC-DSW02	17.2	NA	NA	1.7
	44-EC-DSW03	20.9	NA	NA	2.1
	44-EC-DSW04	20.8	NA	NA	2.1
	44-EC-DSW05	33.3	NA	NA	3.3
	44-UT-DSW01	26.3	NA	NA	2.6
	44-UT-DSW03	29.7	NA	NA	3.0
Nickel	44-EC-DSW01	19.8	2.4	0.3	2.4
	44-EC-DSW02	12.1	1.5	0.2	1.5

Notes:

Shaded Samples are Quotient Indices That Exceed "1"

NE = Not Established

WQS = Water Quality Standard

SWSV = Surface Water Screening Value

TABLE 7-11

**SEDIMENT QUOTIENT INDEX
SITE 44, JONES STREET DUMP
REMEDIAL INVESTIGATION CTO-0303
MCAS, NEW RIVER, NORTH CAROLINA**

Contaminant	Station	Concentration	Quotient Index		
			ER-L	ER-M	SQC
Semivolatiles (µg/kg)					
Butylbenzylphthalate	44-UT-SD02-06	48J	0.8	NA	84.2
Chrysene	44-UT-SD03-06	460	1.2	0.2	0.09
Fluoranthene	44-UT-SD03-06	740	1.2	0.2	0.01
Pentachlorophenol	44-EC-SD01-612	740J	2.1	NE	1.4
Phenanthrene	44-UT-SD03-06	250	1	0.17	0.01
Pesticides (µg/kg)					
Alpha-chlordane	44-EC-SD01-06	2.3J	4.6	0.4	3.2
	44-EC-SD01-612	2.7J	5.4	0.5	3.7
	44-EC-SD02-06	2	4.0	0.3	1.4
	44-EC-SD02-612	3.3J	6.6	0.6	4.5
	44-EC-SD03-612	2.4J	4.8	0.4	3.3
	44-EC-SD04-06	2.6J	5.2	0.4	3.6
	44-EC-SD04-612	2.9J	5.8	0.5	4.0
	44-EC-SD05-06	6.1J	12.2	1.02	8.4
	44-EC-SD05-612	14J	28.0	2.3	19.2
	44-UT-SD02-06	5.1NJ	10.2	0.9	0.1
	44-UT-SD02-612	2.6NJ	5.2	0.4	0.0
	44-UT-SD03-06	5.6J	11.2	0.9	0.1
	44-UT-SD03-612	7.8J	15.6	1.3	0.1
Gamma-chlordane	44-EC-SD01-06	2.7J	5.4	0.5	3.7
	44-EC-SD01-612	2.7J	5.4	0.5	3.7
	44-EC-SD02-06	2.8	5.6	0.5	2.0
	44-EC-SD02-612	4.2J	8.4	0.7	5.8
	44-EC-SD03-612	2.8J	5.6	0.5	3.8
	44-EC-SD04-06	3J	6.0	0.5	4.1
	44-EC-SD04-612	3.3J	6.6	0.6	4.5
	44-EC-SD05-06	6.5J	13.0	1.1	8.9
	44-EC-SD05-612	16J	32.0	2.7	21.9
	44-UT-SD02-06	5.1J	10.2	0.9	0.1
	44-UT-SD02-612	3.6J	7.2	0.6	0.1
	44-UT-SD03-06	6.9J	13.8	1.2	0.1
	44-UT-SD03-612	9.5J	19.0	1.6	0.2

TABLE 7-11 (Continued)

SEDIMENT QUOTIENT INDEX
 SITE 44, JONES STREET DUMP
 REMEDIAL INVESTIGATION CTO-0303
 MCAS, NEW RIVER, NORTH CAROLINA

Contaminant	Station	Concentration	Quotient Index		
			ER-L	ER-M	SQC
4'4-DDD	44-EC-SD01-06	81	40.5	4.1	81.0
	44-EC-SD01-612	34J	17.0	1.7	34.0
	44-EC-SD02-06	66	33.0	3.3	34.2
	44-EC-SD02-612	120	60	6.0	120.0
	44-EC-SD03-06	23J	12	1.2	23.0
	44-EC-SD03-612	35J	18	1.8	35.0
	44-EC-SD04-06	33J	16.5	1.7	33.0
	44-EC-SD04-612	43J	22	2.2	43.0
	44-EC-SD05-06	140	70.0	7.0	140
	44-EC-SD05-612	370	185	18.5	370
	44-UT-SD01-06	5.5J	2.8	0.3	0.1
	44-UT-SD01-612	13J	6.5	0.7	0.1
	44-UT-SD02-06	85	42.5	4.3	0.99
	44-UT-SD02-612	770	385	38.5	8.9
	44-UT-SD03-06	14J	7.0	0.7	0.2
	44-UT-SD03-612	21J	10.5	1.1	0.2
4'4-DDE	44-EC-SD01-06	30J	13.6	1.1	5.2
	44-EC-SD01-612	21J	9.5	0.8	3.7
	44-EC-SD02-06	24J	10.9	0.9	2.2
	44-EC-SD02-612	58J	26	2.1	10.1
	44-EC-SD03-06	9.3J	4	0.3	1.6
	44-EC-SD03-612	17J	8	0.6	3.0
	44-EC-SD04-06	20J	9.1	0.7	3.5
	44-EC-SD04-612	21J	9.5	0.8	3.7
	44-EC-SD05-06	56J	25.5	2.1	9.8
	44-EC-SD05-612	150J	68.2	5.6	26.2
	44-UT-SD01-06	20J	9.1	0.7	0.0
	44-UT-SD01-612	25J	11.4	0.9	0.0
	44-UT-SD02-06	110J	50.0	4.1	0.2
	44-UT-SD02-612	310J	141	11.5	0.6
	44-UT-SD03-06	9.9J	4.5	0.4	0.0
	44-UT-SD03-612	15J	6.8	0.6	0.0

TABLE 7-11 (Continued)

SEDIMENT QUOTIENT INDEX
 SITE 44, JONES STREET DUMP
 REMEDIAL INVESTIGATION CTO-0303
 MCAS, NEW RIVER, NORTH CAROLINA

Contaminant	Station	Concentration	Quotient Index		
			ER-L	ER-M	SQC
4'4-DDT	44-EC-SD01-06	9J	9	1.3	28.1
	44-EC-SD01-612	3.1J	3	0.4	9.7
	44-EC-SD02-06	4.4J	4.4	0.6	7.2
	44-EC-SD02-612	3.8J	3.8	0.5	11.9
	44-EC-SD04-06	2.6J	2.6	0.4	8.1
	44-EC-SD04-612	2.5J	2.5	0.4	7.8
	44-EC-SD05-06	6.5J	6.5	0.9	20.3
	44-EC-SD05-612	130	130	18.6	406
	44-UT-SD02-06	3.7J	3.7	0.5	0.1
	44-UT-SD02-612	3.1J	3.1	0.4	0.1
Heptachlor epoxide	44-UT-SD03-612	5.2J	NA	NA	57.8
Inorganics (mg/kg)					
Lead	44-UT-SD03-06	53J	1.1	0.2	NA
	44-UT-SD03-612	56.3J	1.2	0.3	NA
Selenium	44-UT-SD01-612	1.4	1.4	NA	NA

Notes:

Shaded samples are Quotient Indices that exceed "1"

- NE = Not Established
- ER-L = Effects Range Low
- ER-M = Effects Range Median
- SQC = Sediment Quality Criteria

TABLE 7-12

**TERRESTRIAL INTAKE MODEL QUOTIENT INDICES
SITE 44, JONES STREET DUMP
REMEDIAL INVESTIGATION, CTO-0303
MCAS, NEW RIVER, NORTH CAROLINA**

Contaminant of Potential Concern	Red Fox	Bobwhite Quail	Cottontail Rabbit	Raccoon	Whitetail Deer
Acetone	1.59e-04	3.43e-04	9.17e-03	2.23e-04	2.02e-04
1,1-Dichloroethene	1.43e-05	2.89e-06	1.05e-05	3.90e-05	8.76e-06
1,2-Dichloroethene (total)	5.99e-03	1.21e-03	4.42e-03	1.64e-02	3.68e-03
1,1,2,2-Tetrachloroethane	9.22e-05	1.87e-05	6.81e-05	2.35e-04	5.67e-05
1,1,2-Trichloroethane	1.16e-03	2.35e-04	8.57e-04	2.78e-03	7.13e-04
Trichloroethene	7.25e-05	1.47e-05	5.35e-05	3.10e-04	4.45e-05
Vinyl chloride	2.10e-02	4.25e-03	1.55e-02	2.88e-02	1.29e-02
Bis(2-chloroethyl)ether	NA	NA	NA	NA	NA
Benzo(g,h,i)perylene	2.11e-05	2.73e-04	2.74e-03	1.09e-04	2.03e-05
Bis(2-ethylhexyl)phthalate	2.47e-03	3.61e-04	1.34e-02	9.95e-02	1.61e-03
2,6-Dinitrotoluene	1.51e-04	3.22e-03	9.11e-02	5.01e-04	1.13e-03
Indeno(1,2,3-cd)pyrene	2.20e-05	2.84e-04	2.85e-03	1.13e-04	2.11e-05
Phenol	3.33e-05	6.74e-06	2.46e-05	4.80e-05	2.04e-05
4,4'-DDD	1.76e-07	5.84e-05	2.67e-05	9.01e-07	2.22e-07
4,4'-DDE	8.72e-06	2.98e-03	1.50e-03	4.42e-05	1.34e-05
4,4'-DDT	1.34e-06	4.32e-04	1.79e-04	6.91e-06	1.35e-06
Aluminum	1.31e-02	5.77e-01	3.46e+00	1.17e+01	1.47e-02
Arsenic	3.48e-03	3.92e-04	9.83e-03	1.48e-02	2.64e-04
Barium	2.93e-02	3.07e-02	4.14e-01	9.61e-02	1.78e-02
Chromium	3.12e-04	1.77e-04	1.15e-03	1.61e-03	2.32e-05
Copper	1.79e-03	3.70e-02	9.02e-01	5.32e-03	5.85e-02
Iron	2.16e-02	1.35e-01	1.62e+00	7.70e-02	2.19e-02
Lead	3.55e-04	5.42e-03	8.74e-02	4.26e-03	3.54e-03
Manganese	3.60e-03	4.01e-04	2.71e-02	4.01e-02	4.44e-03
Nickel	5.66e-05	1.55e-04	7.55e-03	1.31e-02	1.77e-03
Vanadium	1.09e-02	9.68e-04	1.65e+00	1.81e-02	2.84e-03
Zinc	1.02e-02	6.36e-03	2.25e-01	1.42e-03	7.89e-03
Total Quotient Index	1.26e-01	8.08e-01	8.54e+00	1.21e+01	1.54e-01

Notes:

Shaded boxes are Quotient Indices that exceed "1"

SECTION 7.0 FIGURES

FIGURE 7-1

CONCEPTUAL EXPOSURE MODEL FOR ECOLOGICAL RECEPTORS
SITE 43, AGAN STREET DUMP

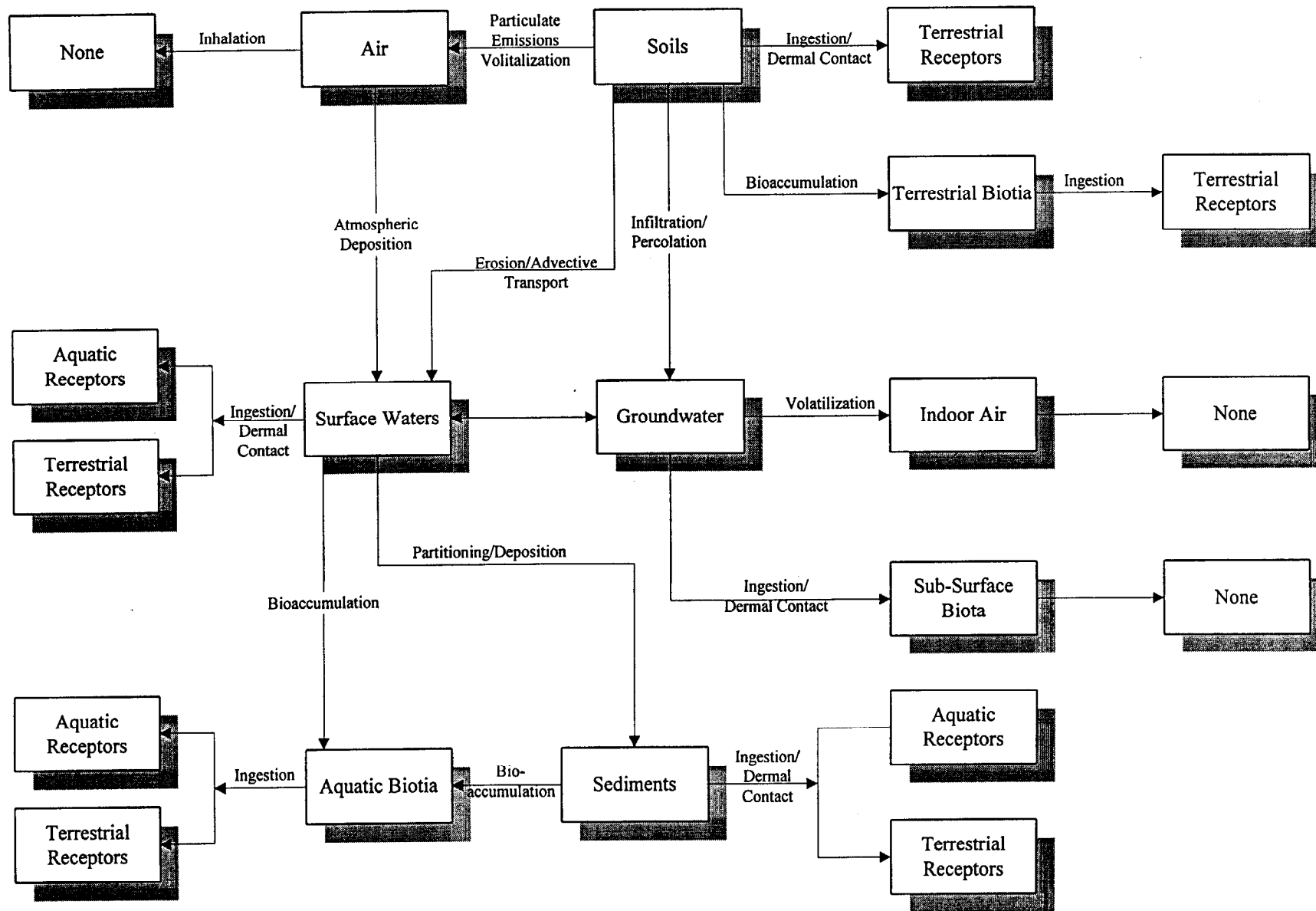

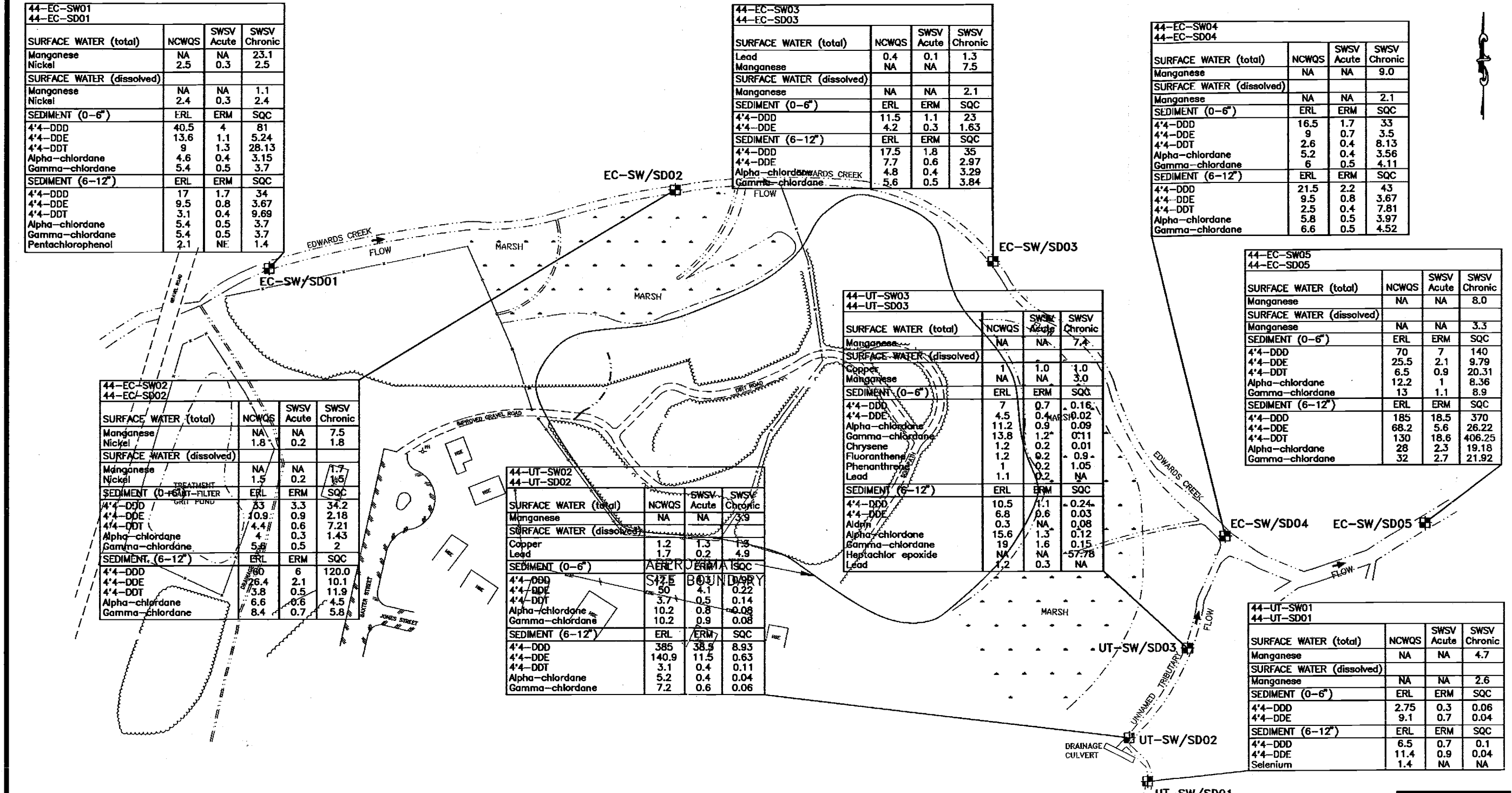

44-EC-SW01
44-EC-SD01

SURFACE WATER (total)	NCWQS	SWSV Acute	SWSV Chronic
Manganese	NA	NA	23.1
Nickel	2.5	0.3	2.5
SURFACE WATER (dissolved)			
Manganese	NA	NA	1.1
Nickel	2.4	0.3	2.4
SEDIMENT (0-6")			
4'4-DDD	40.5	4	81
4'4-DDE	13.6	1.1	5.24
4'4-DDT	9	1.3	28.13
Alpha-chlordane	4.6	0.4	3.15
Gamma-chlordane	5.4	0.5	3.7
SEDIMENT (6-12")			
4'4-DDD	17	1.7	34
4'4-DDE	9.5	0.8	3.67
4'4-DDT	3.1	0.4	9.69
Alpha-chlordane	5.4	0.5	3.7
Gamma-chlordane	5.4	0.5	3.7
Pentachlorophenol	2.1	NE	1.4

44-EC-SW03
44-EC-SD03

SURFACE WATER (total)	NCWQS	SWSV Acute	SWSV Chronic
Lead	0.4	0.1	1.3
Manganese	NA	NA	7.5
SURFACE WATER (dissolved)			
Manganese	NA	NA	2.1
SEDIMENT (0-6")			
4'4-DDD	11.5	1.1	23
4'4-DDE	4.2	0.3	1.63
SEDIMENT (6-12")			
4'4-DDD	17.5	1.8	35
4'4-DDE	7.7	0.6	2.97
Alpha-chlordane	4.8	0.4	3.29
Gamma-chlordane	5.6	0.5	3.84

44-EC-SW04
44-EC-SD04

SURFACE WATER (total)	NCWQS	SWSV Acute	SWSV Chronic
Manganese	NA	NA	9.0
SURFACE WATER (dissolved)			
Manganese	NA	NA	2.1
SEDIMENT (0-6")			
4'4-DDD	16.5	1.7	33
4'4-DDE	9	0.7	3.5
4'4-DDT	2.6	0.4	8.13
Alpha-chlordane	5.2	0.4	3.56
Gamma-chlordane	6	0.5	4.11
SEDIMENT (6-12")			
4'4-DDD	21.5	2.2	43
4'4-DDE	9.5	0.8	3.67
4'4-DDT	2.5	0.4	7.81
Alpha-chlordane	5.8	0.5	3.97
Gamma-chlordane	6.6	0.5	4.52

44-EC-SW02
44-EC-SD02

SURFACE WATER (total)	NCWQS	SWSV Acute	SWSV Chronic
Manganese	NA	NA	7.5
Nickel	1.8	0.2	1.8
SURFACE WATER (dissolved)			
Manganese	NA	NA	1.7
Nickel	1.5	0.2	1.5
SEDIMENT (0-6")			
4'4-DDD	33	3.3	34.2
4'4-DDE	10.9	0.9	2.18
4'4-DDT	4.4	0.6	7.21
Alpha-chlordane	4	0.3	1.43
Gamma-chlordane	5.4	0.5	2
SEDIMENT (6-12")			
4'4-DDD	80	6	120.0
4'4-DDE	16.4	2.1	10.1
4'4-DDT	3.8	0.5	11.9
Alpha-chlordane	6.6	0.6	4.5
Gamma-chlordane	8.4	0.7	5.8

44-UT-SW02
44-UT-SD02

SURFACE WATER (total)	NCWQS	SWSV Acute	SWSV Chronic
Manganese	NA	NA	3.9
SURFACE WATER (dissolved)			
Copper	1.2	1.3	1.3
Lead	1.7	0.2	4.9
SEDIMENT (0-6")			
4'4-DDD	57.5	4.1	0.22
4'4-DDE	50	0.5	0.14
4'4-DDT	3.7	0.5	0.08
Alpha-chlordane	10.2	0.8	0.08
Gamma-chlordane	10.2	0.9	0.08
SEDIMENT (6-12")			
4'4-DDD	385	38.5	8.93
4'4-DDE	140.9	11.5	0.63
4'4-DDT	3.1	0.4	0.11
Alpha-chlordane	5.2	0.4	0.04
Gamma-chlordane	7.2	0.6	0.06

44-UT-SW03
44-UT-SD03

SURFACE WATER (total)	NCWQS	SWSV Acute	SWSV Chronic
Manganese	NA	NA	7.5
SURFACE WATER (dissolved)			
Copper	1	1.0	1.0
Manganese	NA	NA	3.0
SEDIMENT (0-6")			
4'4-DDD	7	0.7	0.16
4'4-DDE	4.5	0.4	0.02
Alpha-chlordane	11.2	0.9	0.09
Gamma-chlordane	13.8	1.2	0.11
Chrysene	1.2	0.2	0.01
Fluoranthene	1.2	0.2	0.9
Phenanthrene	1	0.2	1.05
Lead	1.1	0.2	NA
SEDIMENT (6-12")			
4'4-DDD	10.5	1.1	0.24
4'4-DDE	6.8	0.6	0.03
Aldrin	0.3	NA	0.08
Alpha-chlordane	15.6	1.3	0.12
Gamma-chlordane	19	1.6	0.15
Heptachlor epoxide	NA	NA	57.78
Lead	1.2	0.3	NA

44-EC-SW05
44-EC-SD05

SURFACE WATER (total)	NCWQS	SWSV Acute	SWSV Chronic
Manganese	NA	NA	8.0
SURFACE WATER (dissolved)			
Manganese	NA	NA	3.3
SEDIMENT (0-6")			
4'4-DDD	70	7	140
4'4-DDE	25.5	2.1	9.79
4'4-DDT	6.5	0.9	20.31
Alpha-chlordane	12.2	1	8.36
Gamma-chlordane	13	1.1	8.9
SEDIMENT (6-12")			
4'4-DDD	185	18.5	370
4'4-DDE	68.2	5.6	26.22
4'4-DDT	130	18.6	406.25
Alpha-chlordane	28	2.3	19.18
Gamma-chlordane	32	2.7	21.92

44-UT-SW01
44-UT-SD01

SURFACE WATER (total)	NCWQS	SWSV Acute	SWSV Chronic
Manganese	NA	NA	4.7
SURFACE WATER (dissolved)			
Manganese	NA	NA	2.6
SEDIMENT (0-6")			
4'4-DDD	2.75	0.3	0.06
4'4-DDE	9.1	0.7	0.04
SEDIMENT (6-12")			
4'4-DDD	6.5	0.7	0.1
4'4-DDE	11.4	0.9	0.04
Selenium	1.4	NA	NA

LEGEND

- EC-SW/SD01 SURFACE WATER AND SEDIMENT SAMPLING LOCATION
- FLOW DIRECTION OF SURFACE WATER FLOW
- MARSH
- EOE OVERHEAD ELECTRIC LINE & UTILITY POLE
- FENCE
- ASPHALT ROAD
- GRAVEL OR DIRT ROAD
- EDGE OF CREEK, DRAINAGE DITCH, MARSH OR POND
- TREE LINE
- HSE BASE HOUSING UNIT

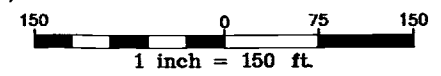

FIGURE 7-2
 QUOTIENT INDICES THAT EXCEED "1"
 IN SURFACE WATER AND SEDIMENT
 SITE 44, JONES STREET DUMP
 REMEDIAL INVESTIGATION, CTO-0303
 MARINE CORPS AIR STATION, NEW RIVER
 NORTH CAROLINA

01715410Z

8.0 CONCLUSIONS AND RECOMMENDATIONS

8.1 Conclusions

The following conclusions were derived from the RI conducted at Site 44:

- VOCs were detected throughout Edwards Creek. The highest levels of VOCs were detected in samples obtained from sampling stations located upgradient of Site 44. Based upon the distribution of positive detections, the source of VOCs does not appear to be originating from Site 44. Several potential sources have been identified upgradient of Site 44 and will be investigated during future studies.
- No unacceptable human health risks were calculated based on exposure to site surface water or sediment. Pesticides in sediment posed moderate ecological risks to aquatic receptors. Metals in site surface water were found at levels greater than criteria and may pose slight risks to aquatic receptors. Based upon soil screening values, metal levels in soil posed a potential risk to terrestrial receptors.
- Iron was detected at levels exceeding NCWQS levels in groundwater samples obtained throughout Site 44. Iron in groundwater posed a potential risk to human health at Site 44. As noted in the report, iron is a very common constituent in all media at MCB, Camp Lejeune.

8.2 Recommendations

The following recommendations are provided based on the RI findings:

- A No Action Record of Decision should be prepared as the preferred remedial alternative.
- All site monitoring wells should be abandoned in accordance with state and federal procedures.