

03.13-08/22/96-01717

FINAL

**REMEDIAL INVESTIGATION REPORT
OPERABLE UNIT NO. 6
(SITE 54)
VOLUME VIII
MARINE CORPS BASE
CAMP LEJEUNE, NORTH CAROLINA**

**CONTRACT TASK ORDER 0303
TEXT AND FIGURES**

AUGUST 22, 1996

Prepared For:

**DEPARTMENT OF THE NAVY
ATLANTIC DIVISION
NAVAL FACILITIES
ENGINEERING COMMAND
*Norfolk, Virginia***

Under:

**LANTDIV CLEAN Program
Contract N62470-89-D-4814**

Prepared by:

**BAKER ENVIRONMENTAL, INC.
*Coraopolis, Pennsylvania***

TABLE OF CONTENTS

	<u>Page</u>
EXECUTIVE SUMMARY	ES-1
1.0 INTRODUCTION	1-1
1.1 Report Organization	1-1
1.2 Background and Setting of MCB, Camp Lejeune	1-2
1.2.1 Location and Setting	1-2
1.2.2 History	1-2
1.2.3 Operable Unit Description	1-2
1.2.4 Topography	1-3
1.2.5 Surface Water Hydrology	1-3
1.2.6 Geology	1-3
1.2.7 Hydrogeology	1-4
1.2.8 Ecology	1-5
1.2.9 Land Use Demographics	1-9
1.2.10 Meteorology	1-10
1.3 Background and Setting of Site 54	1-10
1.3.1 Site Location and Setting	1-10
1.3.2 Site History	1-11
1.4 Previous Investigations	1-11
1.4.1 Initial Assessment Study	1-11
1.4.2 Confirmation Study	1-11
1.5 Remedial Investigation Objectives	1-13
1.6 References	1-13
2.0 SITE CHARACTERISTICS	2-1
2.1 Topography and Surface Features	2-1
2.2 Surface Water Hydrology	2-1
2.3 Soil	2-1
2.4 Geology	2-1
2.5 Hydrogeology	2-2
2.5.1 Groundwater Elevation Data	2-2
2.5.2 Groundwater Flow Contour Maps	2-3
2.5.3 Hydraulic Properties	2-3
2.5.4 Groundwater Flow Velocities	2-4
2.5.5 General Groundwater Flow Patterns	2-4
2.6 Identification of Water Supply Wells	2-4
2.7 Ecology	2-5
2.8 References	2-7
3.0 STUDY AREA INVESTIGATIONS	3-1
3.1 Site Survey	3-1
3.2 Soil Investigation	3-1
3.2.1 Soil Sampling Procedures	3-2
3.2.2 Sampling Locations	3-3

TABLE OF CONTENTS
(Continued)

	<u>Page</u>
3.2.3 Analytical Program	3-3
3.2.4 Quality Assurance and Quality Control	3-4
3.2.5 Air Monitoring and Field Screening	3-5
3.3 Groundwater Investigation	3-5
3.3.1 Monitoring Well Installation	3-5
3.3.2 Monitoring Well Development	3-7
3.3.3 Water Level Measurements	3-7
3.3.4 Aquifer Testing	3-7
3.3.5 Sampling Locations	3-7
3.3.6 Sampling Procedures	3-8
3.3.7 Analytical Program	3-9
3.3.8 Quality Assurance and Quality Control	3-9
3.3.9 Field Screening and Air Monitoring	3-9
3.4 Habitat Evaluation	3-9
3.5 Decontamination Procedures	3-9
3.6 Investigation Derived Waste (IDW) Handling	3-10
3.7 References	3-10
4.0 NATURE AND EXTENT OF CONTAMINATION	4-1
4.1 Data Quality	4-1
4.1.1 Data Management and Tracking	4-1
4.2 Non-Site Related Analytical Results	4-2
4.2.1 Laboratory Contaminants	4-2
4.2.2 Naturally-Occurring Inorganic Analytes	4-3
4.3 Analytical Results	4-4
4.3.1 Soil Investigation	4-4
4.3.2 Groundwater Investigation	4-6
4.4 Extent of Contamination	4-8
4.4.1 Extent of Soil Contamination	4-8
4.4.2 Extent of Groundwater Contamination	4-9
4.5 References	4-11
5.0 CONTAMINANT FATE AND TRANSPORT	5-1
5.1 Chemical and Physical Properties Impacting Fate and Transport	5-1
5.2 Contaminant Transport Pathways	5-2
5.2.1 Windblown Dust	5-3
5.2.2 Leaching of Soil Contaminants to Groundwater	5-3
5.2.3 Migration of Groundwater Contaminants	5-3
5.2.4 Migration of Contaminants in Runoff (Surface Water)	5-5
5.3 Fate and Transport Summary	5-5
5.3.1 Volatile and Semivolatile Organic Compounds	5-6
5.3.2 Polynuclear Aromatic Hydrocarbons (PAHs)	5-7
5.3.3 Metals	5-7
5.4 References	5-8

TABLE OF CONTENTS
(Continued)

	<u>Page</u>
6.0	BASELINE HUMAN HEALTH RISK ASSESSMENT 6-1
6.1	Introduction 6-1
6.2	Hazard Identification 6-2
6.2.1	Data Evaluation and Reduction 6-2
6.2.2	Identification of Data Suitable for Use in a Quantitative Risk Assessment 6-3
6.2.3	Criteria Used in Selection of COPCs 6-3
6.2.4	Contaminants of Potential Concern (COPCs) 6-8
6.3	Exposure Assessment 6-10
6.3.1	Potential Human Receptors and Adjacent Populations 6-10
6.3.2	Exposure Pathways 6-11
6.3.3	Quantification of Exposure 6-13
6.3.4	Calculation of Chronic Daily Intakes 6-15
6.4	Toxicity Assessment 6-22
6.4.1	Carcinogenic Slope Factor 6-23
6.4.2	Reference Dose 6-24
6.4.3	Lead 6-25
6.4.4	Dermal Adjustment of Toxicity Factors 6-26
6.5	Risk Characterization 6-26
6.5.1	Human Health Risks 6-27
6.6	Lead UBK Model Results 6-28
6.7	Sources of Uncertainty 6-28
6.7.1	Analytical Data 6-29
6.7.2	Exposure Assessment 6-29
6.7.3	Sampling Strategy 6-30
6.7.4	Toxicity Assessment 6-31
6.8	Conclusions of the BRA for Site 54 6-32
6.8.1	Current Scenario 6-32
6.8.2	Future Scenario 6-32
6.9	References 6-33
7.0	ECOLOGICAL RISK ASSESSMENT 7-1
7.1	Objectives, Scope, and Organization of the Ecological Risk Assessment ... 7-1
7.2	Problem Formulation 7-2
7.3	Contaminants of Potential Concern 7-2
7.3.1	Criteria for Selecting Contaminants of Potential Concern 7-2
7.3.2	Selection of Contaminants of Potential Concern 7-5
7.3.3	Physical/Chemical Characteristics of COPCs 7-7
7.4	Ecosystems Potentially at Risk 7-7
7.5	Ecological Endpoints 7-8
7.5.1	Aquatic Endpoints 7-8
7.5.2	Terrestrial Endpoints 7-8
7.6	Conceptual Model 7-8
7.6.1	Soil Exposure Pathway 7-9

TABLE OF CONTENTS
(Continued)

	<u>Page</u>
7.6.2	Groundwater Exposure Pathway 7-9
7.6.3	Air Exposure Pathway 7-10
7.7	Exposure Assessment 7-10
7.8	Ecological Effects Characterization 7-10
7.8.1	Surface Soil 7-10
7.8.2	Groundwater 7-11
7.8.5	Terrestrial Chronic Daily Intake Model 7-12
7.9	Risk Characterization 7-13
7.9.1	Groundwater 7-14
7.9.2	Terrestrial Chronic Daily Intake Model 7-14
7.10	Ecological Significance 7-14
7.10.1	Aquatic Receptors 7-14
7.10.2	Terrestrial Receptors 7-15
7.10.3	Threatened and Endangered Species 7-15
7.10.4	Wetlands 7-15
7.11	Uncertainty Analysis 7-16
7.12	Conclusions 7-17
7.12.1	Aquatic Receptors 7-17
7.12.2	Terrestrial Receptors 7-17
7.13	References 7-18
8.0	CONCLUSIONS AND RECOMMENDATIONS 8-1
8.1	Conclusions 8-1
8.2	Recommendations 8-1

APPENDICES

A	Test Boring Records
B	Test Boring and Well Construction Records
C	Immunoassay Field Testing Results
D	Chain-of-Custody Forms
E	Field Well Development Records
F	Investigation Derived Waste Summary and Recommendations
G	Sampling Summary
H	Data and Frequency Summaries
I	Statistical Summaries
J	Field Duplicate Summaries
K	QA/QC Sampling Summary
L	Grain Size and TPH Analytical Results
M	Wet Chemistry Analytical Results
N	Aquifer Test Results
O	Aquifer Property Calculations
P	Base Background Analytical Results and Evaluation Report
Q	Shower Model
R	Lead UBK Model
S	Site Conceptual Model
T	CDI Calculations
U	Field Data Sheets
V	Screening Value and Quotient Index Calculations
W	Terrestrial Reference Values and CDI Calculations

LIST OF TABLES

- ES-1 Summary of Site Contamination

- 1-1 Geologic and Hydrogeologic Units of North Carolina's Coastal Plain
- 1-2 Summary of Hydraulic Properties Unrelated Site Investigations
- 1-3 Hydraulic Property Estimates of the Castle Hayne Aquifer
- 1-4 Protected Species Within MCB, Camp Lejeune
- 1-5 Land Utilization Within Developed Areas of MCB, Camp Lejeune
- 1-6 Climatic Data Summary Marine Corps Air Station, New River
- 1-7 Summary of Well Construction Details Confirmation Study
- 1-8 Detected Target Contaminants in Groundwater Confirmation Study
- 1-9 Detected Target Contaminants in Sediment
- 1-10 Remedial Investigation Objectives

- 2-1 Summary of Soil Physical Properties
- 2-2 Summary of Groundwater Elevations
- 2-3 Hydraulic Properties Summary
- 2-4 Summary of Potable Water Supply Wells Within a One-mile Radius

- 3-1 Soil Sampling Summary Test Borings
- 3-2 Soil Sampling Summary Monitoring Well Test Borings
- 3-3 Quality Assurance/Quality Control Sampling Program Soil Investigation
- 3-4 Summary of Well Construction Details
- 3-5 Summary of Water Level Measurements
- 3-6 Summary of Groundwater Field Parameters
- 3-7 Groundwater Sampling Summary
- 3-8 Quality Assurance/Quality Control Sampling Program Groundwater Investigation

- 4-1 Summary of Rejected Data
- 4-2 Summary of Site Contamination
- 4-3 Surface Soil -Positive Detection Summary, TCL Organics
- 4-4 Surface Soil -Positive Detection Summary, TAL Metals
- 4-5 Subsurface Soil -Positive Detection Summary, TCL Organics
- 4-6 Subsurface Soil -Positive Detection Summary, TAL Metals
- 4-7 Groundwater -Positive Detection Summary, TCL Organics
- 4-8 Groundwater -Positive Detection Summary, TAL Metals
- 4-9 Groundwater -Positive Detection Summary, TAL Dissolved Metals

- 5-1 Organic Physical and Chemical Properties
- 5-2 Relative Mobilities of Metals as a Function of Environmental Conditions (Eh, pH)

- 6-1 Contaminants of Potential Concern in Surface Soil
- 6-2 Contaminants of Potential Concern in Subsurface Soil
- 6-3 Contaminants of Potential Concern in Groundwater
- 6-4 Summary of Exposure Dose Input Parameters
- 6-5 Summary of Exposure Pathways
- 6-6 Summary of Health-Based Criteria

LIST OF TABLES (Continued)

- 6-7 Summary of Dermal-Adjusted Health-Based Criteria
- 6-8 Summary of Risks for the Military Receptor
- 6-9 Summary of Risks for the Child Trespasser
- 6-10 Summary of Risks for the Future Child Resident
- 6-11 Summary of Risks for the Adult Trespasser
- 6-12 Summary of Risks for the Future Adult Resident
- 6-13 Summary of Risks for the Construction Worker
- 6-14 Summary of Uncertainties in the Results of the Human Health Risk Assessment
- 6-15 Summary of Contaminants Contributing to Site Risks

- 7-1 Frequency and Range of Contaminant Detections Compared to Surface Water Screening Values
- 7-2 Contaminants of Concern in Each Media
- 7-3 Physical/Chemical Characteristics of the COPCs
- 7-4 Frequency and Range of Contaminant Detections Compared to Soil Flora and Fauna Screening Values
- 7-5 Exposure Parameters for Chronic Daily Intake Model
- 7-6 Groundwater Quotient Index
- 7-7 Terrestrial Intake Model Quotient Indices

LIST OF FIGURES

- 1-1 Operable Unit No. 6 - Sites 36, 43, 44, 54, and 86
- 1-2 Operable Units and Site Locations
- 1-3 Locations of Hydrogeologic Cross-Sections
- 1-4 Hydrogeologic Cross-Sections
- 1-5 Site Map, Site 54 - Crash Crew Fire Training Burn Pit
- 1-6 Site Inspection Sampling Locations

- 2-1 Cross-section Location Map
- 2-2 Geologic Cross-sections A-A' through D-D'
- 2-3A Groundwater Elevation Trends
- 2-3B Groundwater Elevation Trends
- 2-4 Surficial Aquifer Groundwater Contour Map
- 2-5 Deep Surficial Aquifer Groundwater Contour Map
- 2-6 Potable Water supply Wells within a One-Mile Radius
- 2-7 Biohabitat Map

- 3-1 Soil Sampling Locations
- 3-2 Monitoring Well Locations
- 3-3 Typical Shallow Type II Groundwater Monitoring Well Construction Diagram
- 3-4 Typical Shallow Type III Groundwater Monitoring Well Construction Diagram

- 4-1 Organic Compounds in Surface Soil
- 4-2 Organic Compounds in Subsurface Soil
- 4-3 Organic Compounds in Groundwater
- 4-4 TAL Metals in Groundwater Above Screening Standards

- 6-1 Flowchart of Potential Exposure Pathways and Receptors
- 6-2 Cumulative Probability Percent of Blood Lead Levels
- 6-3 Probability Distribution of Blood Lead Levels

- 7-1 Flowchart of Potential Exposure Pathways and Ecological Receptors
- 7-2 Quotient Indices that Exceeded "1" in Surface Water and Sediment

LIST OF ACRONYMS AND ABBREVIATIONS

AET	Apparent Effects Threshold
AQUIRE	Aquatic Information Retrieval Database
ARAR	Applicable or Relevant and Appropriate Requirement
AST	Above Ground Storage Tank
ASTM	American Society for Testing and Materials
ATSDR	Agency for Toxic Substances and Disease Registry
AWQC	Ambient Water Quality Criteria
BaB	Baymeade
Baker	Baker Environmental, Incorporated
Bb	Beef Biotransfer Factor
BCF	Bioconcentration Factor
BEHP	Bis(2-ethylhexyl)phthalate
bgs	Below Ground Surface
BI	Biotic Index
Br	Plant Biotransfer Factor (fruit)
BRA	Baseline Human Health Risk Assessment
BTEX	Benzene, Toluene, Ethylbenzene, and Xylene
Bv	Plant Biotransfer Factor (leaf)
°C	Degrees Celsius
Carc.	Carcinogenic Effects
CDI	Chronic Daily Intake
CERCLA	Comprehensive Environmental Response, Compensation and Liability Act
CLEJ	Camp Lejeune
CLP	Contract Laboratory Program
COC	Contaminant of Concern
COPC	Contaminant of Potential Concern
CRAVE	Carcinogen Risk Assessment Verification Endeavor
CRDL	Contract Required Detection Limit
CRQL	Contract Required Quantitation Limit
CSF	Carcinogenic Slope Factor
DC	Direct Current
DEM	Division of Environmental Management
DO	Dissolved Oxygen
DOD	Department of the Defense
DoN	Department of the Navy
DQO	Data Quality Objective
EDB	Ethyl Dibromide
EMD	Environmental Management Division (Camp Lejeune)
EPIC	Environmental Photographic Interpretation Center
ER-L	Effects Range - Low
ER-M	Effects Range - Median
ERA	Ecological Risk Assessment
ESE	Environmental Science and Engineering

LIST OF ACRONYMS AND ABBREVIATIONS
(Continued)

°F	Degrees Fahrenheit
FFA	Federal Facilities Agreement
FID	Flame Ionization Detector
ft	Feet
FWS	Fish and Wildlife Service
gpm	Gallons per Minute
GW	Groundwater Well
H'	Species Diversity (Shannon-Wiener)
H	Species Diversity (Brillouins')
HA	Health Advisories
HEAST	Health Effects Assessment Summary Tables
HHAG	Human Health Assessment Group
HI	Hazard Index
HPIA	Hadnot Point Industrial Area
HQ	Hazard Quotient
IAS	Initial Assessment Study
ICR	Estimated Incremental Lifetime Cancer Risk
ID	Internal Diameter
IDW	Investigation Derived Waste
IRIS	Integrated Risk Information System
IRP	Installation Restoration Program
K_{oc}	Organic Carbon Partition Coefficient
K_{ow}	Octanol Water Partition Coefficient
LANTDIV	Naval Facilities Engineering Command, Atlantic Division
LOAEL	Lowest-Observed-Adverse-Effect-Level
MAG	Marine Air Groups
MBI	Macroinvertebrate Biotic Index
MCAS	Marine Corps Air Station
MCB	Marine Corps Base
MCL	Maximum Contaminant Level
MEK	Methyl Ethyl Ketone
MF	Modifying Factor
mg/L	Milligrams per Liter
mg/kg	Milligrams per Kilogram
MI	Mobility Index
MIBK	Methyl Isobutyl Ketone
MS/MSD	Matrix Spike and Matrix Spike Duplicate
msl	Mean Sea Level

LIST OF ACRONYMS AND ABBREVIATIONS
(Continued)

NC DEHNR	North Carolina Department of Environment, Health, and Natural Resources
NCP	National Contingency Plan
NCWQS	North Carolina Water Quality Standards
ND	Nondetect
NEESA	Naval Energy and Environmental Support Activity
NEHC	Navy Environmental Health Center
NFESC	Naval Facilities Engineering Service Center
NOAA	National Oceanic and Atmospheric Administration
NOAEL	No-Observed-Adverse-Effect-Level
NOEL	No-Observed-Effect Level
Noncarc.	Noncarcinogenic Effects
NPL	National Priorities List
NWI	National Wetlands Inventory
O&G	Oil and Grease
ORNL	Oak Ridge National Laboratory
OSWER	Office of Solid Waste and Emergency Response
OU	Operable Unit
PAH	Polynuclear Aromatic Hydrocarbon
PCB	Polychlorinated Biphenyl
PID	Photoionization Detector
ppb	Parts per Billion
ppm	Parts per Million
PVC	Polyvinyl Chloride
QA/QC	Quality Assurance/Quality Control
QI	Quotient Index
R	Retardation Factor
RA	Risk Assessment
RBC	Region III Risk-Based Concentration
RCRA	Resource Conservation and Recovery Act
RfD	Reference Dose
RI/FS	Remedial Investigation/Feasibility Study
RI	Remedial Investigation
RME	Reasonable Maximum Exposure
ROD	Record of Decision
S	Solubility
SA	Site Assessment
SAP	Sampling and Analysis Plan
SCS	Soil Conservation Service
SD	Sediment
SI	Suite Investigation
Sj	Jaccard Coefficient

LIST OF ACRONYMS AND ABBREVIATIONS
(Continued)

SM-SP	Fine Sand and Loamy Fine Sand
SMCL	Secondary Maximum Contaminant Level
SOP	Standard Operating Procedure
SQC	Sediment Quality Criteria
Ss	Sørensen Index
SSL	Sediment Screening Level
SSV	Sediment Screening Value
SSSV	Surface Soil Screening Value
STP	Sewage Treatment Plant
SU	Standard Unit
SVOC	Semivolatile Organic Compound
SW	Surface Water
SWSV	Surface Water Screening Value
TAL	Target Analyte List
TBC	To Be Considered
TCE	Trichloroethylene
TCL	Target Compound List
TCLP	Toxicity Characteristic Leaching Procedure
TDS	Total Dissolved Solids
TIC	Tentatively Identified Compound
TOC	Total Organic Carbon
TOC	Top-of-Casing
TPH	Total Petroleum Hydrocarbon
TRV	Terrestrial Reference Value
TSS	Total Suspended Solids
µg/L	Micrograms per Liter
µg/g	Micrograms per Gram
µg/kg	Micrograms per Kilogram
UBK	Uptake/Biokinetics
UCL	Upper Confidence Limit
UF	Uncertainty Factor
USCS	Unified Soil Classification System
USEPA	United States Environmental Protection Agency
USGS	United States Geological Survey
UST	Underground Storage Tank
VOC	Volatile Organic Compound
VP	Vapor Pressure
WAR	Water and Air Research, Incorporated
WOE	Weight-of-Evidence
WQS	Water Quality Standards
WQSV	Water Quality Screening Values

EXECUTIVE SUMMARY

INTRODUCTION

The purpose of an RI is to evaluate the nature and extent of the threat to public health and the environment caused by the release or threatened release of hazardous substances, pollutants, or contaminants. This RI investigation was conducted through the sampling of several environmental media (soil, groundwater, surface water, sediment, and fish tissue) at OU No. 6, evaluating the resultant analytical data, and performing a human health risk assessment (RA) and ecological RA. This RI report contains the results of all field investigations, the human health RA, and the ecological RA. Furthermore, the RI report provides information to support the FS and Record of Decision (ROD) documents.

Operable Unit Description

OU No. 6 is located within the northwest portion of the facility, to the south and east of Camp Geiger Development Area. Site 36 is referred to as the "Camp Geiger Area Dump," Site 43 is the "Agan Street Dump," Site 44 is known as the "Jones Street Dump," Site 54 is the "Crash Crew Fire Training Burn Pit," and Site 86 is known as the "Tank Area AS419-AS421 at MCAS."

Site Description and History

The Crash Crew Fire Training Burn Pit (Site 54) is located near the southwest end of runway 5-23, within the operations area of MCAS New River. The burn pit is approximately 50 feet in diameter and is situated at the center of this 1.5 acre site. An 8,000-gallon underground storage tank (UST) lies to the northwest of the burn pit. Fire training exercises are conducted within the burn pit using IP-type fuel, which is stored in the nearby UST. An oil and water separator, located approximately 100 feet to the southeast of the burn pit, is used for temporary storage and collection of the spent fuel.

An improved gravel surface surrounds the burn pit, the remaining portion of the site is comprised of maintained lawn area. The ground surface slopes away from the central portion of the study area toward the south, southwest, and southeast. Two drainage ditches lead away from the burn pit area toward the south, on either side of an improved road. During periods of heavy precipitation, the ditches serve as channels for surface water runoff.

According to the Initial Assessment Study (IAS), Site 54 has served as a fire training burn pit since the mid-1950s. Waste fuels, oils, and solvents were used to simulate fire conditions that would result from aircraft crashes. Fire training at Site 54 was originally conducted on the ground surface, within a bermed area. In 1975 a lined burn pit was constructed (WAR, 1983). The same burn pit remains in operation today, however, only JP-type fuels are currently used during training exercises.

GEOLOGY

A generally consistent depositional sequence was observed in borings throughout Site 54. The exception is a thin, discontinuous fine-grained layer, called the Belgrade Formation. The uppermost beds are undifferentiated. The surficial aquifer lies within the sediments of this undifferentiated formation. Less permeable, fine-grained sediments below the undifferentiated formation comprise

the Belgrade Formation, also called the Castle Hayne confining unit. According to Cardinell, et. al., 1993, the Belgrade Formation constitutes part of the surficial aquifer and Castle Hayne confining unit. In this report, for the purpose of simplicity, the less permeable sediments below the undifferentiated formation will be referred to as a distinct unit; the Belgrade Formation (Castle Hayne confining unit). The River Bend Formation lies below the Belgrade Formation and is primarily characterized by beds of partially cemented shell fragments. The upper portion of the Castle Hayne aquifer lies within sediments of the River Bend Formation.

The uppermost formation at Site 54, the undifferentiated formation, consists of several units of Holocene and Pleistocene ages. This formation typically extends to a depth between 15 to 20 feet below ground surface (bgs). The upper 2 feet of soil appears to be fill or reworked soil, particularly in the area around the burn pit. Compacted layers of gravel, sand, silt, and/or clay were observed. Otherwise, a predominantly silty fine sand or silt is present at the surface. Sediments of the undifferentiated formation tend to coarsen with depth, and are generally medium dense. Thin, discontinuous lenses of clay, and clay and silt are scattered throughout the undifferentiated formation.

The Belgrade Formation, which is usually a well-defined and fine-grained unit, was observed to be thin and discontinuous under Site 54. These units are identified as the "Possible Castle Hayne confining unit" on the cross sections, and the formation contact is projected in places because of the discontinuous nature. However, these fine-grained units are at elevations consistent with elevations described by Cardinell, and generally match the description of the confining unit as less permeable sediments. These fine-grained units generally contain clay with lesser amounts of fine sand and silt of the Miocene age. This formation is typically 12 to 16 feet bgs, and can be less than 2 feet thick in places. The sediments of this formation are very soft to soft.

The River Bend Formation lies under the Belgrade Formation where present, but is generally in direct contact with the undifferentiated formation. The River Bend Formation consists of several units of the Oligocene age. This formation lies 12 to 22 feet bgs at Site 54. The formation predominantly consists of fine to medium sand south of the burn pit, and predominantly silty fine sand to fine sand east of the burn pit. Sediments in this formation are generally medium dense. Cemented and partially cemented shell fragments, typical of the River Bend Formation at other OU 6 sites, were observed only at 54-GW07.

HYDROGEOLOGY

There are several aquifers beneath Site 54 and vicinity. The upper two aquifers were investigated in this study; the surficial and Castle Hayne. The surficial aquifer occurs within the sediments of the undifferentiated formation typically within 10 feet of the surface. The surficial aquifer is 5 to 10 feet thick where the Belgrade Formation is present. The upper portion of the Castle Hayne aquifer occurs within the sediments of the River Bend Formation. According to U.S. Geological Survey report (Cardinell, et. al, 1993), the Castle Hayne aquifer is approximately 200 feet thick in the vicinity of Camp Geiger and the Air Station.

The average surficial aquifer hydraulic conductivity at Site 54 is about half of the value presented by Cardinell. The average hydraulic conductivity value at Site 54, based on RI slug tests, is 22.5 feet/day, compared to 50 feet/day presented in Cardinell. The Cardinell value was estimated based on a general composition of fine sand, mixed with some silt and clay. The average hydraulic conductivity and transmissivity for the Castle Hayne at Site 54 is 32.0 feet²/day and 6,390 feet²/day,

respectively. Cardinell reported hydraulic conductivities and transmissivities from several studies.

Hydraulic conductivities ranged from 14 to 91 feet/day, and transmissivities range from 820 to 26,000 feet²/day. The RI results at Site 54 are comparable to the results at other sites throughout MCB Camp Lejeune.

For the surficial aquifer, calculated groundwater flow velocities varied by one order of magnitude, ranging from 0.16 to 1.01 feet/day. The higher velocity at 54-GW06 is attributable to relatively high hydraulic conductivity of the fine to coarse sands observed at 54-GW06.

For the Castle Hayne aquifer, calculated groundwater flow velocities varied by nearly one order of magnitude, ranging from 0.46 feet/day to 1.25 feet/day. The higher velocity at 54-GW08 is attributable to relatively high hydraulic conductivity of the fine to medium sands observed at 54-GW08.

Groundwater in the surficial aquifer at Site 54 flows toward a tributary west of the site with an average velocity of 0.45 feet per day. Groundwater flow in the upper Castle Hayne aquifer is also toward the tributary with an average velocity of 0.86 feet/day. The unnamed tributary west of the site represents a groundwater flow boundary at Site 54. It is evident that groundwater discharges to the tributary based groundwater flow direction and on the elevation of the creek relative to groundwater elevations.

REMEDIAL INVESTIGATION ACTIVITIES

The field investigation program at OU No. 6, Site 54, was initiated to detect and characterize potential impacts to human health and the environment resulting from past waste management activities. This section discusses the site-specific RI field investigation activities that were conducted to fulfill the objective. The RI field investigation of OU No.6 commenced on February 20, 1995 and continued through May 10, 1995. The RI field program at Site 54 consisted of a site survey; a soil investigation, which included drilling and sampling; a groundwater investigation, which included monitoring well installation, sampling, and aquifer testing; and a habitat evaluation. The following sections detail the various investigation activities carried out during the RI.

A total of 34 borings were completed at Site 54 to assess the suspected impact of burn pit operations; two of those borings were utilized for the installation of monitoring wells. Eighteen of the 34 borings were collected during the initial screening investigation. Based upon the initial screening results, nine borings were completed at locations identified for further confirmation sampling. As stipulated in the Final RI/FS Work Plan for OU No.6 (Baker, 1994), the remaining five soil borings were collected from a dry ditch which provides surface water drainage for the burn pit area. Two additional borings, to the north of the study area, were advanced to assess background contaminant concentrations (54-BB-SB01 and 54-BB-SB02).

Fourteen of the 18 field screening samples were collected from immediately surrounding the burn pit. The remaining four field screening samples were collected from a smaller area to the southwest of the burn pit, identified during a project scoping site visit. This smaller outlying area was characterized by a lack of vegetative cover, possibly resulting from site operations. Results of the field test screening process were used to position the subsequent confirmation test borings, temporary wells, and permanent wells.

The analytical program employed during the soil investigation at Site 54 focused on suspected contaminants of concern, as indicated by information regarding previous burn pit operations and investigation results. The 18 samples generated during the initial soil screening event were analyzed for petroleum hydrocarbons using an immunoassay field test. The field testing was performed with an EnSys PETRO RIS[®] Soil Test System in accordance with proposed EPA Method 4030 for immunoassay-based field screening of petroleum compounds in soil. Immunoassay results were recorded in units relative to 15 and 60 parts per million (ppm). Four of the 18 screening samples were submitted to the laboratory for confirmation analyses.

Based upon results from the initial screening investigation, portions of the study area were identified for confirmatory investigation. Each of the subsequent nine soil samples were analyzed for TPH, TCL volatiles, and TCL semivolatiles. Two of the nine samples and each of the five ditch samples were analyzed for both TAL inorganics and full TCL organics (i.e., volatiles, semivolatiles, pesticides, and PCBs). Samples were prepared and handled as described in the previous section.

In addition to analyzing for the contaminants of concern, three composite soil samples were collected for analysis of engineering parameters (i.e., particle size, and Atterberg limits). Engineering samples were comprised of individual grab samples collected from the ground surface to the water table.

Groundwater samples were collected from three existing shallow wells (54-GW01, 54-GW02, and 54-GW03), the seven newly installed shallow wells (54-GW04 through 54-GW10), and seven temporary wells (54-TW01 through 54-TW07) at Site 54. The groundwater sampling round was conducted at Site 54 in April of 1995.

Groundwater samples from three existing shallow wells, seven newly installed shallow wells, and seven temporary wells were submitted for laboratory analysis from Site 54. Samples from each of the ten permanent wells (54-GW01 through 54-GW10) and the three temporary wells adjacent to the burn pit (54-TW01 through 54-TW03) were analyzed for full TCL organics (i.e., volatiles, semivolatiles, pesticides, and PCBs), TAL total metals, total suspended solids (TSS), and total dissolved solids (TDS). In addition, the groundwater samples obtained from 54-TW02 and 54-GW06 were also analyzed for TAL dissolved metals. The four remaining temporary wells, placed adjacent to an on-site UST, were analyzed for TCL volatiles and TCL semivolatiles only. The groundwater samples were analyzed using Contract Laboratory Program (CLP) protocols and Level IV data quality.

During the habitat evaluation at Site 54, dominant vegetation types and species were identified in the field; those plants that could not be readily identified were collected for further examination in the office. Amphibians, reptiles, birds, and mammals were also identified as visual sightings or evidence allowed. In many cases, the animals themselves were not seen, but scat, tracks, feeding areas, or remains were noted. From this information, ecological communities were established and biohabitat maps developed.

EXTENT OF CONTAMINATION

This section presents a summary of analytical findings from field sampling activities conducted at Site 54. Table ES-1 provides a summary of site contamination for Site 54.

Soils

SVOCs were identified in both surface and subsurface soil samples from the southern and southwestern portions of the study area. The majority of SVOCs detected in soil samples were PAH compounds. Only one SVOC (2-methylnaphthalene) and one VOC (acetone) were detected at concentrations greater than 1,000 µg/kg.

Inorganic analytes were detected in both surface and subsurface soil samples at concentrations above twice the average applicable base-specific background levels. The metals chromium, lead, nickel, and zinc were observed at maximum concentrations within 5 mg/kg of twice their average base specific background levels.

Groundwater

Inorganics were the most prevalent and widely distributed potential contaminants in groundwater at Site 54. Iron and manganese were the most prevalent inorganic analytes, detected at concentrations that exceeded state standards within nine groundwater samples each. Lead was detected in an upgradient well at a concentration which exceeded the state standard by nearly 25 µg/L. No other inorganics were detected above applicable screening standards.

Positive detections of organic compounds were limited to portions of the study area immediately adjacent to the burn pit or UST and extending southwest of the burn pit. The presence of volatile and semivolatile compounds in samples obtained from this portion of the study area is consistent with current site operations. Six positive detections of benzene and five positive detections of naphthalene exceeded applicable NCWQS values of 1 and 21 µg/L.

HUMAN HEALTH RISK ASSESSMENT

At Site 54, exposure to surface soil was assessed for the current receptors. Soil and groundwater exposure were evaluated for the future receptors.

In the current case, the following receptors were assessed: military personnel and adult and child trespassers. Receptor exposure to surface soil was evaluated. The calculated risk values for these receptors were within acceptable risk levels.

In the future case, child and adult residents were assessed for potential exposure to groundwater and subsurface soil. A construction worker was evaluated for surface and subsurface soil exposure. The future risk calculated for the construction worker was within acceptable risk levels.

TABLE ES-1

**SUMMARY OF SITE CONTAMINATION
SITE 54, CRASH CREW FIRE TRAINING BURN PIT
REMEDIAL INVESTIGATION, CTO-0303
MCAS, NEW RIVER, NORTH CAROLINA**

Media	Fraction	Detected Contaminants	Comparison Criteria		Site Contamination				
			Standard	Base Background	Min.	Max.	Max. Location	Detection Frequency	Distribution
Surface Soil	Volatiles	ND	NA	NA				0/11	
	Semivolatiles	n-Nitrosodiphenylamine	NA	NA	160	160	DD-SB01	1/11	south, drainage ditch
		Phenanthrene (PAH)	NA	NA	98	120	DD-SB03	2/11	south, drainage ditch
		Fluoranthene (PAH)	NA	NA	62	67	DD-SB01	2/11	south, drainage ditch
		Pyrene (PAH)	NA	NA	99	150	DD-SB01	2/11	south, drainage ditch
		Butylbenzylphthalate	NA	NA	50	320	DD-SB04	2/11	south, drainage ditch
		Di-n-octylphthalate	NA	NA	150	150	SB08	1/11	southwest of burn pit
	PCBs	ND	NA	NA				0/4	
	Metals (1)	Chromium	NA	6.7	5.7	9.1	DD-SB04	4/4	3 exceed BB, drainage ditch
		Zinc	NA	13.9	8.3	16.7	DD-SB04	4/4	2 exceed BB, drainage ditch
Subsurface Soil	Volatiles	Acetone	NA	NA	1,200	1,200	DD-SB05	1/19	1 exceeds blank, drainage ditch
		Xylene (total)	NA	NA	12	300	SB08	2/19	southwest of burn pit
	Semivolatiles	Naphthalene (PAH)	NA	NA	760	760	SB08	1/19	southwest of burn pit
		2-Methylnaphthalene	NA	NA	1,700	1,700	DD-SB05	1/19	south, drainage ditch
		Acenaphthene (PAH)	NA	NA	94	94	DD-SB05	1/19	south, drainage ditch
		Fluorene (PAH)	NA	NA	420	420	DD-SB05	1/19	south, drainage ditch
		Phenanthrene (PAH)	NA	NA	160	160	DD-SB05	1/19	south, drainage ditch
		Pyrene (PAH)	NA	NA	43	43	DD-SB05	1/19	south, drainage ditch
	Butylbenzylphthalate	NA	NA	56	56	DD-SB03	1/19	south, drainage ditch	
	PCBs	ND	NA	NA				0/8	
	Metals (1)	Lead	NA	8.3	1.4	11.5	DD-SB03	8/8	3 exceed BB, scattered
Nickel		NA	3.7	1.1	6.2	DD-SB02	6/8	2 exceed BB, south and southwest	

TABLE ES-1 (Continued)

SUMMARY OF SITE CONTAMINATION
 SITE 54, CRASH CREW FIRE TRAINING BURN PIT
 REMEDIAL INVESTIGATION, CTO-0303
 MCAS, NEW RIVER, NORTH CAROLINA

Media	Fraction	Detected Contaminants	Comparison Criteria		Site Contamination				
			Standard	Base Background	Min.	Max.	Max. Location	Detection Frequency	Distribution
Groundwater	Volatiles	Carbon Disulfide	NCWQS - 700	NA	4	4	54-GW10	1/17	does not exceed standard, east
		1,2-Dichloroethene (total)	MCL - 70	NA	5	23	54-TW03	3/17	none exceed standard, southeast
		Trichloroethene	MCL - 5	NA	1	1	54-TW03	1/17	does not exceed standard, southeast
		Benzene	NCWQS - 1	NA	5	40	54-TW04	6/17	6 exceed standard, south and east
		Toluene	NCWQS - 1,000	NA	22	83	54-TW03	2/17	do not exceed standard, southeast
		Ethylbenzene	NCWQS - 29	NA	6	26	54-TW04	3/17	none exceed standard, southeast
		Xylene (total)	NCWQS - 530	NA	27	130	54-TW03	3/17	none exceed standard, southeast
	Semivolatiles	Phenol	NCWQS - 300	NA	1	1	54-TW04	1/17	does not exceed standard, east
		Nitrobenzene	NA	NA	2	2	54-TW04	1/17	east of burn pit, adjacent to UST
		2,4-Dimethylphenol	NA	NA	3	3	54-TW06	1/17	east of burn pit, adjacent to UST
		Naphthalene (PAH)	NCWQS - 21	NA	1	240	54-TW03	7/17	5 exceed standard, south and east
		2-Methylnaphthalene	NA	NA	1	160	54-TW03	6/17	south and east, 3 of 6 at UST
		Diethylphthalate	NCWQS - 5,000	NA	1	37	54-TW03	5/17	none exceed standard, southeast
		Anthracene (PAH)	NCWQS - 2,100	NA	1	1	54-TW05	1/17	does not exceed standard, UST
		Di-n-butylphthalate	NCWQS - 700	NA	1	2	54-GW09	2/17	do not exceed standard, scattered

ES-7

TABLE ES-1 (Continued)

SUMMARY OF SITE CONTAMINATION
 SITE 54, CRASH CREW FIRE TRAINING BURN PIT
 REMEDIAL INVESTIGATION, CTO-0303
 MCAS, NEW RIVER, NORTH CAROLINA

Media	Fraction	Detected Contaminants	Comparison Criteria		Site Contamination				
			Standard	Base Background	Min.	Max.	Max. Location	Detection Frequency	Distribution
Groundwater (Continued)	Pesticides	ND	MCL/NCWQS	NA				0/1	
	PCBs	ND	MCL/NCWQS	NA				0/13	
	Total Metals	Iron	NCWQS - 300	NA	193	74,100	54-TW03	12/13	9 exceed standard, scattered
		Lead	NCWQS - 15	NA	1.9	39.7	54-GW02	5/13	1 exceeds standard, upgradient
	Manganese	NCWQS - 50	NA	25.2	1,280	54-GW03	13/13	9 exceed standard, scattered	

Notes:

- Concentrations are presented in $\mu\text{g/L}$ for liquid and $\mu\text{g/Kg}$ for solids (ppb), metal concentrations for soils and sediments are presented in mg/Kg (ppm).
- (1) Metals in both surface and subsurface soils were compared to twice the average base background positive concentrations for priority pollutant metals only (i.e., antimony, arsenic, beryllium, cadmium, chromium, copper, lead, mercury, nickel, selenium, silver, thallium, zinc).
- BB - Base background, value equals two times average value for soil (refer to Appendix Q)
- NA - Not applicable
- NCWQS - North Carolina Water Quality Standard
- ND - Not detected
- MCL - Federal Maximum Contaminant Level
- PAH - Polynuclear aromatic hydrocarbon

The total noncarcinogenic risk and carcinogenic risk for the adult resident exceeded acceptable risk levels of one for noncarcinogenic effects and 1×10^{-4} for carcinogenic effects. These values were 8.3 and 1.4×10^{-4} , respectively. The total noncarcinogenic risk for the child resident, 20, was also greater than the acceptable risk level of one. In both cases, groundwater ingestion was the main exposure route contributing to these unacceptable risks. In terms of lead effects, exposure to the maximum concentration of lead in the groundwater for a child receptor indicates the potential for adverse health effects. The maximum levels of iron and lead and the lognormal 95% UCL value of arsenic in groundwater contributed to these risks.

As stated previously, groundwater is not currently used potably at the site. Future residential development of the site is unlikely. Based on this information, the future groundwater exposure scenario evaluated in this BRA, although highly protective of human health, is unlikely to occur.

Arsenic was detected frequently in the site groundwater at levels greater than the risk-based screening level. However, these same levels were below both federal and state safe drinking water criteria (i.e., MCLs).

As explained in Section 3.0 of this report, groundwater in the MCB Camp Lejeune area is naturally rich in iron. There is no record of any historical use of iron at Site 54. Consequently, it is assumed that iron is a naturally-occurring inorganic in groundwater, and its presence is not attributable to site operations.

Iron is an essential nutrient. The toxicity values associated with exposure to this metal are based on provisional studies, which have not been verified by USEPA. In fact, if iron were removed from the evaluation of risk from groundwater ingestion, the noncarcinogenic risk for the child would decrease from 19 to 3 and, for the adult, from 8 to 1.2, which is only slightly greater than the acceptable noncarcinogenic risk value of one. As a result, the potential human health risk from exposure to iron in groundwater is a conservative and unrealistic estimate.

ECOLOGICAL RISK ASSESSMENT

Aquatic Receptors

As presented earlier in the ERA, the assessment endpoint for the aquatic receptors is the potential decrease in the aquatic receptor population or subpopulation that is attributable to site-related contaminants. The measurement endpoint is to determine if the contaminant concentrations in the ground water exceed the contaminant-specific surface water effect concentrations (i.e., SWSVs). Several contaminants (xylenes, anthracene, naphthalene, aluminum, barium, cobalt, iron, lead, manganese, and nickel) in the groundwater were detected at concentrations that potentially may cause a decrease in the aquatic population if they were detected at similar concentrations in surface water.

Anthracene and nickel only exceeded the SWSVs in one out of 17 wells; neither COPC exceeded the SWSV in a perimeter well. Xylenes, naphthalene, barium, and manganese while exceeding the screening values, were detected below the concentrations that are expected to cause a decrease in aquatic life using other toxicity data. Aluminum and iron are not considered to be site-related. Finally, lead exceeded the SWSVs in three wells, with the highest concentration being detected in an upgradient well. Due to the low hardness values used to calculate the SWSVs, and the expected

dilution after discharging to the receiving water, the potential decrease in the aquatic life population from lead in the groundwater is expected to be low. In addition, there is a low potential for the remaining COPCs to cause a decrease in the aquatic life population after discharging to the water bodies.

Terrestrial Receptors

As presented earlier in the ERA, the assessment endpoint for the terrestrial receptors is the potential reduction of a receptor population or subpopulation that is attributable to contaminants from the site.

The first measurement endpoint is to determine if there are any exceedances of contaminant-specific soil effect concentrations (i.e., SSSVs). Three SVOCs and three metals (n-nitrosodiphenylamines, phenanthrene, pyrene, aluminum, chromium, and vanadium) exceeded the SSSVs. Therefore, there is a potential for adverse impacts to terrestrial flora, invertebrates, and/or microorganisms from these contaminants. It should be noted that the habitat where these exceedances were located (mowed grass and exposed soil in the drainage ditch), along with the surrounding habitat (mowed field), are not expected to support an ecologically diverse population.

The second measurement endpoint is to determine if the terrestrial CDI exceeds the TRVs. The cottontail rabbit is the only terrestrial species with estimated CDI values that exceeded the TRV values. Due to the location of the surface soil samples with the highest detections (the drainage ditch), and the relatively low QI value, it is unlikely that the contaminants in the surface soil at Site 54 will significantly reduce the rabbit population.

Overall, some potential impacts to soil invertebrates and plants may occur as a result of site-related contaminants. It should be noted that there is much uncertainty in the SSSVs. A potential decrease in the terrestrial vertebrate population from site-related contaminants is not expected based on the terrestrial intake model.

1.0 INTRODUCTION

Marine Corps Base (MCB), Camp Lejeune was placed on the Comprehensive Environmental Response, Compensation, and Liability Act (CERCLA) National Priorities List (NPL) on October 4, 1989 (54 Federal Register 41015, October 4, 1989). Subsequent to this listing, the United States Environmental Protection Agency (USEPA) Region IV; the North Carolina Department of Environment, Health and Natural Resources (NC DEHNR); and the United States Department of the Navy (DoN) entered into a Federal Facilities Agreement (FFA) for MCB, Camp Lejeune. The primary purpose of the FFA is to ensure that environmental impacts associated with past and present activities at MCB, Camp Lejeune are thoroughly investigated and appropriate CERCLA response/Resource Conservation and Recovery Act (RCRA) corrective action alternatives are developed and implemented, as necessary, to protect public health, welfare, and the environment (FFA, 1989).

The Fiscal Year 1996 Site Management Plan for MCB, Camp Lejeune, the primary document referenced in the FFA, identifies 33 sites that require Remedial Investigation/Feasibility Study (RI/FS) activities. These 33 sites have been divided into 16 operable units to simplify RI/FS activities. A RI was conducted at Operable Unit (OU) No. 6, Sites 36, 43, 44, 54, and 86, during February through May of 1995. This report describes the RI conducted at Site 54. Four additional reports have been prepared that address each of the other OU No. 6 sites. Figure 1-1 depicts the location of the five sites that comprise OU No. 6. [Note that all tables and figures are presented in the back of each section.]

The purpose of an RI is to evaluate the nature and extent of the threat to public health and the environment caused by the release or threatened release of hazardous substances, pollutants, or contaminants. This RI investigation was conducted through the sampling of several environmental media (soil, groundwater, surface water, sediment, and fish tissue) at OU No. 6, evaluating the resultant analytical data, and performing a human health risk assessment (RA) and ecological RA. This RI report contains the results of all field investigations, the human health RA, and the ecological RA. Furthermore, the RI report provides information to support the FS and Record of Decision (ROD) documents.

This RI Report has been prepared by Baker Environmental, Inc. (Baker) and submitted to the USEPA Region IV; the NC DEHNR; MCB, Camp Lejeune Environmental Management Department (EMD); the Navy Environmental Health Center (NEHC); the Agency for Toxic Substances and Disease Registry; and to the Naval Facilities Engineering Command, Atlantic Division (LANTDIV) for their review.

The following subsections describe the arrangement of OU No. 6 and the background and setting of both MCB, Camp Lejeune and Site 54. In addition, Section 1.1 provides an overview of the RI report's organization.

1.1 Report Organization

This RI Report is comprised of one text volume with appendices provided in an additional volume. The following section headings are included within this text volume and provide site-specific investigation findings:

- Study Area Investigation - Section 2.0
- Site Physical Characteristics - Section 3.0
- Nature and Extent of Contamination - Section 4.0
- Contaminant Fate and Transport - Section 5.0
- Baseline Human Health Risk Assessment - Section 6.0
- Ecological Risk Assessment - Section 7.0
- Conclusions - Section 8.0

1.2 Background and Setting of MCB, Camp Lejeune

This section summarizes existing background and setting information pertaining to MCB, Camp Lejeune. The text specifically addresses the location and setting of MCB, Camp Lejeune, its history, topography, surface water hydrology, geology, hydrogeology, ecology, land use, demography and climatology.

1.2.1 Location and Setting

MCB, Camp Lejeune is located on the coastal plain of North Carolina in Onslow County. The facility encompasses approximately 234 square miles and is bisected by the New River. The New River flows in a southeasterly direction and forms a large estuary before entering the Atlantic Ocean. The southeastern border of MCB, Camp Lejeune is the Atlantic Ocean shoreline. The western and northeastern boundaries of the facility are U.S. Route 17 and State Route 24, respectively. The City of Jacksonville borders MCB, Camp Lejeune to the north (refer to Figure 1-1).

1.2.2 History

Construction of MCB, Camp Lejeune began in April 1941 at the Hadnot Point Industrial Area (HPIA), where major functions of the base are centered today. The facility was designed to be the "World's Most Complete Amphibious Training Base." The MCB, Camp Lejeune complex consists of five geographical locations under the jurisdiction of the Base Command. These areas include Camp Geiger, Montford Point, Courthouse Bay, Mainside, and the Rifle Range Area. Site 36 is located within the Camp Geiger operations area. The remaining four of the five sites that comprise OU No. 6 are located within the Marine Corps Air Station (MCAS), New River operations area. Although MCAS New River is under the jurisdiction of a separate command (i.e., MCAS, Cherry Point), environmental compliance issues and Installation Restoration Program (IRP) sites are the responsibility of MCB, Camp Lejeune EMD.

1.2.3 Operable Unit Description

Operable units are formed as an incremental step toward addressing individual site concerns. There are currently 33 IRP sites at MCB, Camp Lejeune, which have been grouped into 16 operable units. Due to the similar nature of suspected waste and their close proximity to one another, Sites 36, 43, 44, 54, and 86 were grouped together as OU No. 6. Figure 1-2 depicts the locations of all 16 operable units at MCB, Camp Lejeune.

OU No. 6 is located within the northwest portion of the facility, to the south and east of Camp Geiger Development Area. Site 36 is referred to as the "Camp Geiger Area Dump," Site 43 is the "Agan Street Dump," Site 44 is known as the "Jones Street Dump," Site 54 is the "Crash Crew Fire Training Burn Pit," and Site 86 is known as the "Above Ground Storage Tank Area."

1.2.4 Topography

The flat topography of MCB, Camp Lejeune is typical of seaward portions of the North Carolina coastal plain. Elevations on the base vary from sea level to 72 feet above mean sea level (msl); however, most of MCB, Camp Lejeune is between 20 and 40 feet above msl.

Drainage at MCB, Camp Lejeune is generally toward the New River, except in areas near the coast where flow is into the Intracoastal Waterway that lies between the mainland and barrier islands. In developed areas of the facility, natural drainage has been altered by asphalt cover, storm sewers, and drainage ditches. Approximately 70 percent of MCB, Camp Lejeune is comprised of broad, flat interstream areas with poor drainage (WAR, 1983).

1.2.5 Surface Water Hydrology

The dominant surface water feature at MCB, Camp Lejeune is the New River. It receives drainage from a majority of the base. The New River is short with a course of approximately 50 miles on the central Coastal Plain of North Carolina. Over most of its length, the New River is confined to a relatively narrow channel in Eocene and Oligocene limestones. South of Jacksonville, the river widens dramatically as it flows across less resistant sands, clays, and marls. At MCB, Camp Lejeune, the New River flows in a southerly direction into the Atlantic Ocean through the New River Inlet. Several small coastal creeks drain the area of MCB, Camp Lejeune not associated with the New River and its tributaries. These creeks flow into the Intracoastal Waterway, which is connected to the Atlantic Ocean by Bear Inlet, Brown's Inlet, and the New River Inlet. The New River, the Intracoastal Waterway, and the Atlantic Ocean converge at the New River Inlet.

Water quality criteria for surface waters in North Carolina have been published under Title 15 of the North Carolina Administrative Code. At MCB, Camp Lejeune, the New River falls into two classifications: SC (estuarine waters not suited for body-contact sports or commercial shellfishing); and SA (estuarine waters suited for commercial shellfishing). The SC classification applies to only three areas of the New River at MCB, Camp Lejeune; the rest of the New River at MCB, Camp Lejeune falls into the SA classification (ESE, 1990).

1.2.6 Geology

MCB, Camp Lejeune is located within the Atlantic Coastal Plain physiographic province. The sediments of this province consist primarily of sand, silt, and clay. Other sediments may be present, including shell beds and gravel. Sediments may be of marine or continental origin. These sediments are found in interfingering beds and lenses that gently dip and thicken to the southeast. Sediments of this type range in age from early Cretaceous to Quaternary time and overlie igneous and metamorphic rocks of pre-Cretaceous age. Table 1-1 presents a generalized stratigraphic column for the Atlantic Coastal Plain of North Carolina (Harned et al., 1989).

United States Geological Survey (USGS) studies at MCB, Camp Lejeune indicate that the base is underlain by sand, silt, clay, calcareous clay and partially cemented limestone. The combined thickness of these sediments beneath the base is approximately 1,500 feet.

1.2.7 Hydrogeology

The aquifers of primary interest are the surficial aquifer and the aquifer immediately below it, the Castle Hayne aquifer. Other aquifers that occur beneath the facility include the Beaufort, Peedee, Black Creek, and upper and lower Cape Fear aquifers. The following summary is a compilation of information which pertains to aquifer characteristics within the MCB, Camp Lejeune area. A generalized hydrogeologic cross-section illustrating the relationship between the aquifers in this area is presented in Figures 1-3 and 1-4.

The surficial aquifer consists of interfingering beds of sand, clay, sandy clay, and silt that contain some peat and shells. The thickness of the surficial aquifer ranges from 0 to 73 feet and averages nearly 25 feet over the MCB, Camp Lejeune area. It is generally thickest in the interstream divide areas and presumed absent where it is cut by the New River and its tributaries. The beds are thin and discontinuous, and have limited lateral continuity. This aquifer is not used for water supply at MCB, Camp Lejeune.

The general lithology of the surficial aquifer and the absence of any thick, continuous clay beds are indications of relatively high vertical conductivity within the aquifer. The estimated lateral hydraulic conductivity of the surficial aquifer in the MCB, Camp Lejeune area is 50 feet per day, and is based on a general composition of fine sand mixed with some silt and clay (Harned et al., 1989). However, data from a number of slug tests conducted by Baker at sites near OU No. 6 indicate much lower lateral hydraulic conductivity values. These values range from 7.2×10^{-4} feet per day to 6.4 feet per day. Table 1-2 presents a summary of hydraulic properties compiled during investigations at other sites located within the developed portion of MCAS, New River.

Between the surficial and the Castle Hayne aquifers lies the Castle Hayne confining unit. This unit consists of clay, silt, and sandy clay beds. In general, the Castle Hayne confining unit may be characterized as a group of less permeable beds at the top of the Castle Hayne aquifer that have been partly eroded or incised in places. The Castle Hayne confining unit is discontinuous, and has a thickness ranging from 0 to 26 feet, averaging about 9 feet where present. There is no discernable trend in the thickness of the confining unit seen in these or related investigations, nor is there any information in the USGS literature regarding any trend of the depth of the confining unit.

Previously recorded data indicate that vertical hydraulic conductivity of the confining unit ranged from 0.0014 to 0.41 feet per day (Cardinell et al., 1993). Data obtained from a pump test conducted by ESE indicated a vertical hydraulic conductivity for this unit ranging from 1.4×10^{-3} to 5.1×10^{-2} feet per day (ESE, 1988). Based on the moderate conductivity values and the thin, discontinuous nature of the confining unit, this unit may only be partly effective in retarding the downward vertical movement of groundwater from the surficial aquifer.

The Castle Hayne aquifer lies below the surficial aquifer and consists primarily of unconsolidated sand, shell fragments, and fossiliferous limestone. Clay, silt, silty and sandy clay, and indurated limestone also occur within the aquifer. The upper part of the aquifer consists primarily of calcareous sand with some continuous and discontinuous thin clay and silt beds. The calcareous sand becomes more limey with depth. The lower part of the aquifer consists of consolidated or poorly consolidated limestone and sandy limestone interbedded with clay and sand.

The Castle Hayne aquifer is about 150 to 350 feet thick, increasing in thickness toward the ocean. The top of the aquifer lies approximately 20 to 73 feet below the ground surface. The top of the

aquifer dips southward and is deepest near the Atlantic coast, east of the New River. The top of the aquifer also forms a basin in the vicinity of Paradise Point. Estimates of hydraulic conductivity indicate a wide variation in range, from 14 to 91 feet per day. Table 1-3 presents estimates of the Castle Hayne aquifer and confining unit hydraulic properties in the vicinity of MCB, Camp Lejeune.

Onslow County and MCB, Camp Lejeune lie in an area where the Castle Hayne aquifer generally contains freshwater; however, the proximity of saltwater in deeper layers just below the aquifer and in the New River estuary is of concern in managing water withdrawals. Over-pumping of the deeper parts of the aquifer could cause encroachment of saltwater. The aquifer generally contains water having less than 250 milligrams per liter (mg/L) chloride throughout the base, except for one USGS well in the southern portion of the base that is screened in the lower portion of the aquifer. Chloride was measured at 960 mg/L in a sample collected in 1989 from this well.

Rainfall in the MCB, Camp Lejeune area enters the ground in recharge areas, infiltrates the soil, and moves downward until it reaches the surficial aquifer. Recharge areas at Camp Lejeune are mainly comprised of interstream areas. In the surficial aquifer, groundwater flows in the direction of lower hydraulic head until it reaches discharge points or fronts. These discharge areas include the New River and its tributaries and the ocean. Though most of the rainfall entering the surficial aquifer discharges to local streams, a relatively small amount infiltrates to the Castle Hayne. The surficial aquifer supplies the primary recharge to the Castle Hayne aquifer. Like the surficial aquifer, the Castle Hayne naturally discharges to the New River and major tributaries; however, pumping of the Castle Hayne may locally influence flow directions.

The potentiometric surface of the surficial aquifer varies seasonally, as seen through the observation of water levels in monitoring wells. The surficial aquifer receives more recharge in the winter than in the summer when much of the water evaporates or is transpired by plants before it can reach the water table. As a result, the potentiometric surface is generally highest in the winter months and lowest in the summer or early fall.

Water levels from wells placed in deeper aquifers, such as the Castle Hayne, were also used to establish potentiometric surfaces. Because the Castle Hayne is at least partially confined from the surficial aquifer and is not influenced by rainfall as strongly as the surficial aquifer, the seasonal variations tend to be slower and smaller than in surficial aquifer.

1.2.8 Ecology

The ecology at MCB Camp Lejeune is discussed in three sections that include ecological communities, sensitive environments and threatened and endangered species.

1.2.8.1 Ecological Communities

MCB, Camp Lejeune is located on North Carolina's coastal plain. A number of natural ecological communities are present within this region. In addition, variations of natural communities have occurred in response to disturbance and intervention (e.g., forest clearing, urbanization). The natural communities found in the area are summarized as follows:

- Mixed Hardwood Forest - Found generally on slopes of ravines. Beech, white oak, tulip, sweetgum, and holly are indicator species.

- Southeastern Evergreen Forest - Dominated by pines, especially longleaf pine.
- Loblolly Pine/Hardwoods Community - Second growth forest that includes loblolly pine with a mix of hardwoods (i.e., oak, hickory, sweetgum, sour gum, red maple, and holly).
- Southern Floodplain Forest - Occurs on the floodplains of rivers. Hardwoods dominate with a variety of species present. Composition of species varies with the amount of moisture.
- Maritime Forest - Develops on the lee side of stable sand dunes protected from the ocean. Live oak is an indicator species along with pine, cedar, yaupon, holly, and laurel oak. Deciduous hardwoods may be present where forest is mature.
- Pocosins - Lowland forest community that develops on highly organic soils that are seasonally flooded. Characterized by plants adapted to drought and acidic soils low in nutrients. Pond pine is the dominant tree with dense layer of evergreen shrubs. Strongly influenced by fire.
- Cypress Tupelo Swamp Forest - Occurs in the lowest and wettest areas of floodplains. Dominated by bald cypress and tupelo.
- Freshwater Marsh - Occurs upstream from tidal marshes and downstream from non-tidal freshwater wetlands. Cattails, sedges, and rushes are present.
- Salt Marsh - Regularly flooded, tidally influenced areas dominated by salt-tolerant grasses. Saltwater cordgrass is a characteristic species. Tidal mud flats may be present during low tide.
- Salt Shrub Thicket - High areas of salt marshes and beach areas behind dunes. Subjected to salt spray and periodic saltwater flooding. Dominated by salt resistant shrubs.
- Dunes/Beaches - Zones from the ocean shore to the maritime forest. Subjected to sand, salt, wind, and water.
- Ponds and Lakes - Low depressional areas where water table reaches the surface or where ground is impermeable. In ponds rooted plants can grow across the bottom. Fish populations in these ponds include redear, bluegill, largemouth bass, and channel catfish.
- Open Water - Marine and estuarine waters as well as all underlying bottoms below the intertidal zone.

MCB, Camp Lejeune covers approximately 150,000 acres or 234 square miles. Marine and estuarine open water account for 26,000 acres and terrestrial and palustrine land account for 85,000 acres. Forests are predominant as terrestrial cover and pine forest is the dominant habitat type. A total of 21,000 acres of the pine forest is loblolly pine, 7700 acres are dominated by longleaf pine

forest, and 3600 acres are dominated by pond pine forest. These pine forests include natural subcommunities that are maintained by fire.

In addition to the pine forest, mixed pine/hardwood forest is present on MCB, Camp Lejeune and accounts for 15,900 acres. An additional 12,100 acres are covered by hardwood forest. Of the wetlands present, estuarine marsh accounts for 700 acres; open freshwater accounts for 200 acres; and dune, beach, and brackish marsh accounts for 2200 acres. Industrial, infrastructure, and administrative areas make up 10,000 acres and artillery impact areas and buffer zones account for 11,000 acres (LeBlond, 1994). The base contains 80 miles of tidal streams, 21 miles of marine shoreline, and 12 freshwater ponds. The soil types range from sandy loams to fine sand and muck, with the dominant series being sandy loam (USMC,1987).

The base drains primarily to the New River via its tributaries. These tributaries include Northeast Creek, Southwest Creek, Cogdels Creek, Wallace Creek, Frenchs Creek, Bear Head Creek, Brinson Creek, Edwards Creek, and Duck Creek. Site-specific information regarding surface water and drainage features is presented in Section 2.0.

Forested areas within the military reservation are actively managed for timber. Game species are also managed for hunting and ponds are maintained for fishing. Game species managed include wild turkey, white-tailed deer, black bear, grey and fox squirrels, bobwhite quail, eastern cottontail and marsh rabbits, raccoons, and wood ducks. About 150 acres are maintained for wildlife food plots.

1.2.8.2 Sensitive Environments

Two areas on MCB, Camp Lejeune have been registered as designated Natural Areas within the North Carolina Natural Heritage Program. These two areas, which encompass 141 acres, are the Longleaf Pine Natural Area and the Wallace Creek Swamp Natural Area. In addition, 12 other Natural Areas at MCB, Camp Lejeune have been recommended for inclusion in the registry.

These Natural Areas contain some of the finest examples of natural communities in North Carolina and support many rare species. A few of these community types are globally rare. The Calcareous Coastal Fringe Forest on the 100-acre midden at Corn Landing is the only known extant example of this community type. Camp Lejeune contains some of the best examples of the following globally-rare, natural community types: Cypress Savanna, Depression Meadow, and Small Depression Pond. The Maritime Evergreen Forest hammocks between Cedar Point and Shell Point are connected by shell tombolos and appear to be a very rare geological formation.

The NC DEHNR's Division of Environmental Management (DEM) has developed guidance pertaining to activities that may impact wetlands (NC DEHNR, 1992). In addition, certain activities affecting wetlands are also regulated by the U.S. Army Corps of Engineers.

The U.S. Fish and Wildlife Service (FWS) has prepared National Wetlands Inventory (NWI) maps for the MCB, Camp Lejeune area. Through stereoscopic analysis of high altitude aerial photographs, wetlands were identified based upon vegetation, visible hydrology, and geography in accordance with Classification of Wetland and Deep-Water Habitats of the United States (Cowardin, et al., 1979). The NWI maps are intended for an initial identification of wetland areas and are not meant to replace an actual wetland delineation survey that may be required by Federal, state and local regulatory agencies.

Site-specific wetland delineations were not conducted at Sites 36, 43, 44, 54, and 86; however, potential wetland areas were noted during the field habitat evaluation. Information regarding potential wetland areas was transferred to the site-specific biohabitat maps provided in Section 2.0. Information regarding sensitive natural areas was reviewed during map preparation and has been transferred to the maps, if applicable.

1.2.8.3 Threatened and Endangered Species

Certain species have been granted protection by the FWS under the Federal Endangered Species Act (16 U.S.C. 1531-1543), and by the North Carolina Wildlife Resources Commission, under the North Carolina Endangered Species Act (G.S. 113-331 to 113-337). The protected species fall into one of the following status classifications: Federal or state endangered, threatened or candidate species; state special concern; state significantly rare; or state watch list. While only the Federal or state threatened or endangered and state special concern species are protected from certain actions, the other classified species may have protection in the future.

Surveys have been conducted to identify threatened and endangered species at MCB, Camp Lejeune and several programs are underway to manage and protect them. Table 1-4 lists Federally protected species present at the base and their protected classification. Of these species, the red-cockaded woodpecker, American alligator, and sea turtles are protected by specific regulatory programs.

The red-cockaded woodpecker requires a mature, living longleaf or loblolly pine environment. The birds live in family groups and young are raised cooperatively. At MCB, Camp Lejeune, 2,512 acres of habitat have been identified and marked for protection. Approximately 3,300 acres are in actively managed red-cockaded woodpecker colonies. Research on the bird at MCB, Camp Lejeune began in 1985 and information has been collected to determine home ranges, population size and composition, reproductive success, and habitat use. An annual roost survey is conducted and 36 colonies of birds have been located.

The American alligator is considered a state special concern specie. It is found in freshwater, estuarine, and saltwater wetlands in MCB, Camp Lejeune. Base wetlands are maintained and protected for alligators; signs have been posted where alligators are known to live. Annual surveys of Wallace, Southwest, French, Duck, Mill, and Stone Creeks have been conducted since 1977 to identify alligators and their habitats on base.

Two protected sea turtles, the Atlantic loggerhead and Atlantic green turtle, nest on Onslow Beach at MCB, Camp Lejeune. The green turtle was found nesting in 1980; this sighting was the first time the species had been observed nesting north of Georgia. The turtle returned to nest in 1985. Turtle nests on the beach are surveyed and protected, turtles are tagged, and annual turtle status reports are issued.

Three bird species, piping plover, Bachmans sparrow, and peregrine falcon have also been identified during surveys at MCB, Camp Lejeune. The piping plover is a shore bird. Piping plovers prefer beaches with broad open sandy flats above the high tide line and feed along the edge of incoming waves. Like the piping plover, Bachmans sparrows have very specific habitat requirements. The sparrows live in open stretches of pines with grasses and scattered shrubs for ground cover. Bachmans sparrows were observed at numerous locations throughout southern portion MCB, Camp Lejeune.

In addition to the protected species that breed or forage at MCB, Camp Lejeune, several protected whales migrate through the coastal waters off the base during spring and fall. These include the Atlantic right whale, finback whale, sei whale, and sperm whale. Before artillery or bombing practice is conducted in the area, aerial surveys are made to assure that whales are not present in the impact areas.

A natural heritage resource study was conducted at MCB, Camp Lejeune (LeBlond, 1994) to identify threatened or endangered plants and areas of significant natural interest. During the resource study 55 rare plant species were documented from Camp Lejeune. These include 1 specie that is classified as Federal Endangered, 1 specie that is classified as Federally Threatened, 9 that are candidates for Federal listing as Endangered or Threatened, 4 that are listed as Endangered or Threatened in the State of North Carolina, and 27 species that are State Rare or State Special Concern. These species are summarized on Table 1-4. In addition, species that are candidates for state listing or are on the North Carolina state watch list were noted.

1.2.9 Land Use Demographics

MCB, Camp Lejeune encompasses an area of approximately 234 square miles. The Installation border is approximately 70 miles, including 21 miles of ocean front and Intracoastal Waterway. Recently, MCB, Camp Lejeune acquired approximately 41,000 additional acres in the Greater Sandy Run area. Table 1-5 provides a breakdown of land uses within the developed portion of the facility.

Land use within MCB, Camp Lejeune is influenced by topography and ground cover, environmental policy, and base operational requirements. Much of the land within MCB, Camp Lejeune consists of freshwater swamps that are wooded and largely unsuitable for development. In addition, 3,000 acres of sensitive estuary and other areas set aside for the protection of threatened and endangered species are to remain undeveloped. Operational restrictions and regulations, such as explosive quantity safety distances, impact-weighted noise thresholds, and aircraft landing and clearance zones, may also greatly constrain and influence development (Master Plan, 1988).

The combined military and civilian population of the MCB, Camp Lejeune and Jacksonville area is approximately 112,000. Nearly 90 percent of the surrounding population resides within urbanized areas. The presence of MCB, Camp Lejeune has been the single greatest factor contributing to the rapid population growth of Jacksonville and adjacent communities, particularly during the period from 1940 to 1960.

1.2.9.1 MCAS, New River

MCAS, New River encompasses 2,772 acres and is located in the northwestern portion of the MCB, Camp Lejeune complex. MCAS, New River includes air support activities, troop housing, and personnel support facilities that surround the aircraft operations and maintenance areas. The air station primarily functions as a helicopter base, however, an increasing contingent of fixed-wing aircraft are also supported. Its present mission is to maintain and operate facilities that provide services and material to Marine Air Groups (MAG) 26 and 29, the two tenant commands. MCAS, New River also maintains a number of other activities and units as designated by the Commandant of the Marine Corps and the Chief of Naval Operations.

1.2.10 Meteorology

Although coastal North Carolina lacks distinct wet and dry seasons, there is some seasonal variation in average precipitation. July tends to receive the most precipitation, and rainfall amounts during summer are generally the greatest. Daily showers during the summer are not uncommon, nor are periods of one or two weeks without rain. Convective showers and thunderstorms contribute to the variability of precipitation during the summer months. October tends to receive the least amount of precipitation, on average. Throughout the winter and spring precipitation occurs primarily in the form of migratory low pressure storms. MCB, Camp Lejeune's average yearly rainfall is 52.4 inches. Table 1-6 presents a climatic summary of data collected during 35 years (January 1955 to December 1990) of observations at MCAS New River.

Coastal Plain temperatures are moderated by the proximity of the Atlantic Ocean, which effectively reduces the average daily fluctuation of temperature. Lying 50 miles offshore at its nearest point, the Gulf Stream tends to have little direct effect on coastal temperatures. The southern reaches of the cold Labrador Current offset any warming effect the Gulf Stream might otherwise provide.

MCB, Camp Lejeune experiences hot and humid summers; however, ocean breezes frequently produce a cooling effect. The winter months tend to be mild, with occasional brief cold spells. Average daily temperatures range from 34°F to 54°F in January, the coldest month, and 72°F to 89°F in July, the hottest month. The average relative humidity, between 78 and 89 percent, does not vary greatly from season to season.

Observations of sky conditions indicate yearly averages of approximately 112 days clear, 105 partly cloudy, and 148 cloudy. Measurable amounts of rainfall occur 118 days per year, on the average. Prevailing winds are generally from the south-southwest 10 months of the year and from the north-northwest during September and October. The average wind speed at MCAS, New River is seven miles per hour.

1.3 Background and Setting of Site 54

The following section provides both the location and setting of Site 54. A brief summary of past waste disposal activities at Site 54 is also provided within this section.

1.3.1 Site Location and Setting

The Crash Crew Fire Training Burn Pit (Site 54) is located near the southwest end of runway 5-23, within the operations area of MCAS New River (see Figure 1-1). The burn pit is approximately 50 feet in diameter and is situated at the center of this 1.5 acre site. An 8,000-gallon underground storage tank (UST) lies to the northwest of the burn pit. Fire training exercises are conducted within the burn pit using JP-type fuel, which is stored in the nearby UST. An oil and water separator, located approximately 100 feet to the southeast of the burn pit, is used for temporary storage and collection of the spent fuel. Figure 1-5 presents a site map of the Crash Crew Fire Training Burn Pit.

An improved gravel surface surrounds the burn pit, the remaining portion of the site is comprised of maintained lawn area. The ground surface slopes away from the central portion of the study area toward the south, southwest, and southeast. Two drainage ditches lead away from the burn pit area

toward the south, on either side of an improved road. During periods of heavy precipitation, the ditches serve as channels for surface water runoff.

1.3.2 Site History

According to the Initial Assessment Study (IAS), Site 54 has served as a fire training burn pit since the mid-1950s. Waste fuels, oils, and solvents were used to simulate fire conditions that would result from aircraft crashes. Fire training at Site 54 was originally conducted on the ground surface, within a bermed area. In 1975 a lined burn pit was constructed (WAR, 1983). The same burn pit remains in operation today, however, only JP-type fuels are currently used during training exercises.

1.4 Previous Investigations

The following subsections detail previous investigation activities at OU No. 6, Site 54.

1.4.1 Initial Assessment Study

An IAS was conducted at Site 54 in 1983. The IAS evaluated the potential hazards at various sites throughout the base, including Site 54. The IAS was based upon review of historical records, aerial photographs, inspections, and personnel interviews. As a result of this process, the IAS recommended that a Confirmation Study be performed at Sites 54.

1.4.2 Confirmation Study

A two-part Confirmation Study was conducted at Site 54 by Environmental Science and Engineering (ESE) from 1984 through 1987. The Verification Step was performed in 1984 and the Confirmation Step was performed in 1986 and 1987. The Confirmation Study at Site 54 focused on the presence of potential contaminants in soil, groundwater, surface water, and sediment. Figure 1-6 provides the sample locations collected during the Confirmation Study investigation. Findings from the Confirmation Study are provided below.

1.4.2.1 Soil Investigation

During the 1984 Verification Step, nine soil borings were completed adjacent to the burn pit. Soil samples were not submitted for laboratory confirmation analyses, instead, a visual determination of contaminants was conducted. The results of the soil boring investigation indicated that a petroleum contaminant underlies the site to the east and southeast of the burn pit. Evidence of petroleum or fuel contamination was detected during auger activities. In addition, during periods of high rainfall, quantities of waste petroleum, oil, and lubricants (POL) were observed to seep from the ground into two parallel drainage ditches leading south, away from the site.

1.4.2.2 Groundwater Investigation

One shallow monitoring well was installed during the initial 1984 investigation. Groundwater samples from the shallow well 54-GW01 and supply well AS-5009 were collected and analyzed for cadmium, chromium, lead, oil and grease (O&G), volatile organic compounds (VOCs), and total phenols. The July 1984 results indicated that chromium, O&G, and phenols were detected in well 54-GW01, and total phenols were detected in the supply well. No VOCs were detected in either of the 1984 samples.

Two additional shallow monitoring wells 54-GW02 and 54-GW03 were installed during the 1986 investigation, one upgradient and one downgradient of 54-GW01 (refer to Figure 1-6). Table 1-7 provides well construction details of the three shallow monitoring wells installed at Site 54. Groundwater samples collected from the two new wells and the existing shallow well were analyzed for the following:

- Cadmium (total)
- Chromium (total)
- Hexavalent Chromium (total)
- Lead (total)
- O&G
- VOCs
- Total Phenols
- Xylenes
- Methyl ethyl ketone
- Methyl isobutyl ketone
- Ethylene dibromide

Table 1-8 presents the analytical results from the 1984, 1986, and 1987 groundwater investigations. The 1986 and 1987 results indicated that the samples collected from upgradient well 54-GW02 contained both total chromium and hexavalent chromium. The sample collected in 1987 from the upgradient well also indicated lead (27 micrograms per liter ($\mu\text{g/L}$)). One of the samples collected from downgradient monitoring well 54-GW03 contained levels of chromium and hexavalent chromium. Each of the shallow monitoring wells indicated concentrations of O&G ranging from 1000 to 3000 $\mu\text{g/L}$. The groundwater sample collected from well 54-GW01 contained the same compounds as in the 1984 sampling event, chromium, O&G and phenols. None of the groundwater samples collected during the 1986 and 1987 sampling investigation contained VOCs.

1.4.2.3 Surface Water and Sediment Investigation

Three surface water and sediment locations were sampled as part of the 1986 Confirmation Study investigation at Site 54. The sampling stations were located along drainages to the south, southeast, and southwest of the burn pit. Surface water samples were analyzed for the same compounds as the groundwater samples that were collected during the Confirmation Study. Sediment samples were analyzed for the following:

- Cadmium (total)
- Chromium (total)
- Hexavalent Chromium (total)
- Lead (total)
- O&G
- VOCs
- Total Phenols
- Ethylene Dibromide

Only one compound was detected within the three surface water samples at Site 54. Total phenols were detected at sample station 54-SW01 with a concentration of 3.0 $\mu\text{g/L}$ (refer to Figure 1-6).

Each of the three sediment samples contained chromium, O&G, and total phenols. Analytical results from the sediment samples are presented on Table 1-9. None of the samples contained VOCs.

1.4.2.4 Conclusions and Recommendations of the Confirmation Study

The Confirmation Study identified low levels of petroleum contamination in soil, groundwater, and sediment at Site 54. Oil and Grease were the most prevalent contaminant group encountered during both rounds of the groundwater investigation. Concentrations of metals in groundwater generally decreased from one sampling round to the next (1984 to 1986). Analytical results from groundwater, surface water, and sediment samples indicated that the actual disposal area may extend further to the west than was first estimated.

The Confirmation Study recommended that further characterization of environmental media be implemented to complete the RI/FS process. However, due to the low toxicity of suspected contaminants, the Confirmation Study suggested that the scope of further investigations be limited. Rather than expending considerable resources to accurately define the volumes of contaminated media, a risk assessment to determine possible risks to human health and the environment was recommended.

1.5 Remedial Investigation Objectives

The purpose of this section is to define the RI objectives that were intended to characterize waste related activities at Site 54, assess potential impacts to public health and environment, and provide feasible alternatives for consideration during preparation of the ROD. The remedial objectives presented have been identified through review and evaluation of existing background information, assessment of potential risks to public health and environment, and consideration of feasible remediation technologies and alternatives. As part of the remedial investigation at Site 54, soil and groundwater investigations were conducted. The information gathered during these investigations was intended to fill existing data gaps and employed to generate human health and ecological risk values. Table 1-10 presents the RI objectives identified for Site 54. In addition, the table provides a general description of the study or investigation efforts that were conducted to obtain the requisite information.

1.6 References

Atlantic Division, Naval Facilities Engineering Command. January 1988. Camp Lejeune Complex Master Plan and Capital Improvements Plan Update. Prepared for the Commanding General, Marine Corps Base, Camp Lejeune, North Carolina.

Baker Environmental, Inc. December 1994. Remedial Investigation/Feasibility Study Work Plan for Operable Unit No. 6 (Sites 36, 43, 44, 54, and 86), Marine Corps Base Camp Lejeune, North Carolina. Final. Prepared for the Department of the Navy, Naval Facilities Engineering Command, Atlantic Division, Norfolk, Virginia.

Baker Environmental, Inc. May 1995. Site Management Plan for Marine Corps Base Camp Lejeune, North Carolina. Draft. Prepared for the Department of the Navy, Naval Facilities Engineering Command, Atlantic Division, Norfolk, Virginia.

Cardinell, A.P., Berg, S.A., and Lloyd, O.B. 1993. Hydrogeologic Framework of U.S. Marine Corps Base at Camp Lejeune, North Carolina: U.S. Geological Survey Water Resources Investigation Report. Report No. 93-4049.

Cowardin, Lewis M., Virginia Carter, Francis C. Golet, and Edward T. LaRoe. December 1979. Classification of Wetlands and Deepwater Habitats of the United States. Performed for U.S. Department of the Interior, Fish and Wildlife Service, Office of Biological Services - FWS/OBS-79/31.

Environmental Science and Engineering, Inc. (ESE) 1990. Site Summary Report. Final. Marine Corps Base, Camp Lejeune, North Carolina. Prepared for the Department of the Navy, Naval Facilities Engineering Command, Atlantic Division, Norfolk, Virginia. ESE Project No. 49-02036.

Environmental Science and Engineering, Inc. (ESE) 1988. Characterization Step Report for Hadnot Point Industrial Area. Marine Corps Base, Camp Lejeune, North Carolina. Prepared for the Department of the Navy, Naval Facilities Engineering Command, Atlantic Division, Norfolk, Virginia. ESE Project No. 49-02036-0150.

Federal Facilities Agreement (FFA) Between United States Environmental Protection Agency, Region IV; the North Carolina Department of Environment, Health and Natural Resources, and United States Department of the Navy, for Marine Corps Base, Camp Lejeune and Marine Corps Air Station, New River, North Carolina. December 6, 1989.

Harned, D.A., Lloyd, O.B., Jr., and Treece, M.W., 1989. Assessment of Hydrologic and Hydrogeologic Data at Camp Lejeune Marine Corps Base, North Carolina: U.S. Geological Survey Water Resources Investigation. Report 89-4096, p. 64.

LeBlond, Richard J., John O. Fussell, and Alvin L. Broswell. February 1994. Inventory of Rare Species, Natural Communities, and Critical Areas of the Camp Lejeune Marine Corps Base, North Carolina. North Carolina Natural Heritage Program, Division of Parks and Recreation, Department of Environment, Health, and Natural Resources, Raleigh, North Carolina.

North Carolina Department of Environment, Health, and Natural Resources (NC DEHNR) May 1992. Interim Guidance for Wetlands Protection. Division of Environment, Water Quality Section.

U.S. Department of the Interior (USDI). March 1982. National Wetland Inventory Map, Camp Lejeune, N.C. Fish and Wildlife Service.

U.S. Marine Corps, MCB, Camp Lejeune (USMC). 1987. Multiple-Use Natural Resources Management Plan. Fish and Wildlife Division, Environmental Management Department, Marine Corps Base, Camp Lejeune, North Carolina.

Water and Air Research, Inc. (WAR) April 1983. Initial Assessment Study of Marine Corps Base Camp Lejeune, North Carolina. Prepared for the Department of the Navy, Naval Energy and Environmental Support Activity, Port Hueneme, California.

SECTION 1.0 TABLES

TABLE 1-1

**GEOLOGIC AND HYDROGEOLOGIC UNITS OF
NORTH CAROLINA'S COASTAL PLAIN
REMEDIAL INVESTIGATION, CTO-0303
MCAS, NEW RIVER, NORTH CAROLINA**

Geologic Units			Hydrogeologic Units
System	Series	Formation	Aquifer and Confining Unit
Quaternary	Holocene/Pleistocene	Undifferentiated	Surficial aquifer
Tertiary	Pliocene	Yorktown Formation ⁽¹⁾	Yorktown confining unit
	Miocene	Eastover Formation ⁽¹⁾	Yorktown Aquifer
		Pungo River Formation ⁽¹⁾	Pungo River confining unit
			Pungo River Aquifer
		Belgrade Formation ⁽²⁾	Castle Hayne confining unit
	Oligocene	River Bend Formation	Castle Hayne Aquifer
	Eocene	Castle Hayne Formation	Beaufort confining unit ⁽³⁾
Paleocene	Beaufort Formation	Beaufort Aquifer	
Cretaceous	Upper Cretaceous	Peedee Formation	Peedee confining unit
			Peedee Aquifer
		Black Creek and Middendorf Formations	Black Creek confining unit
		Black Creek Aquifer	
	Cape Fear Formation		Upper Cape Fear confining unit
			Upper Cape Fear Aquifer
			Lower Cape Fear confining unit
			Lower Cape Fear Aquifer
Lower Cretaceous ⁽¹⁾	Unnamed deposits ⁽¹⁾	Lower Cretaceous confining unit	
		Lower Cretaceous Aquifer ⁽¹⁾	
Pre-Cretaceous basement rocks		--	--

Note:

- ⁽¹⁾ Geologic and hydrologic units probably not present beneath MCB, Camp Lejeune.
- ⁽²⁾ Constitutes part of the surficial aquifer and Castle Hayne confining unit in the study area.
- ⁽³⁾ Estimated to be confined to deposits of Paleocene age in the study area.

Source: Harned et al., 1989.

TABLE 1-2

**SUMMARY OF HYDRAULIC PROPERTIES
UNRELATED SITE INVESTIGATIONS
REMEDIAL INVESTIGATION, CTO-0303
MCAS, NEW RIVER, NORTH CAROLINA**

Well No.	Hydraulic Conductivity Falling Head Test		Hydraulic Conductivity Rising Head Test		Transmissivity	Storativity
	ft/day	cm/sec	ft/day	cm/sec	gal/day/ft	
MW-30A	1.18	4.16E-04	1.5	5.31E-04	--	--
MW-31A	0.346	1.22E-04	0.269	9.51E-05	--	--
MW-35A	0.119	4.20E-05	0.116	4.06E-05	--	--
MW-32B	6.22	2.20E-03	5.15	1.82E-03	--	--
MW-36B	2.91	1.03E-03	3.2	1.13E-03	--	--
MW-37B	7.06	2.49E-03	6.44	2.27E-03	--	--
GWD-1	6.8	2.40E-03	6.03	2.13E-03	--	--
122MW-3	0.25	8.80E-05	0.015	5.30E-06	--	--
122MW-5	0.47	1.70E-04	0.034	1.20E-05	--	--
122MW-12	0.068	2.40E-05	0.0085	3.00E-06	--	--
MW-13 ⁽¹⁾	0.0554	1.96E-05	0.0032	1.13E-06	--	--
MW-14 ⁽¹⁾	0.188	6.62E-05	7.26E-04	2.56E-07	--	--
MW-3 ⁽²⁾	--	--	0.75	2.60E-04	--	--
MW-4 ⁽²⁾	--	--	0.27	9.50E-05	--	--
MW-11 ⁽²⁾	--	--	0.37	1.30E-04	--	--
MW-21 ⁽²⁾	--	--	0.46	1.60E-04	5.5	0.028
RW-1 ⁽²⁾	--	--	--	--	54	--
MW-18 ⁽²⁾	--	--	--	--	790	0.014

Note:

All data compiled from unrelated Baker Investigations within the MCAS, New River operations area.

⁽¹⁾ AS 527

⁽²⁾ Campbell Street Fuel Farm

A = Upper Surficial Aquifer

B = Lower Surficial Aquifer

TABLE 1-3

HYDRAULIC PROPERTY ESTIMATES OF THE CASTLE HAYNE AQUIFER
 REMEDIAL INVESTIGATION, CTO-0303
 MCAS, NEW RIVER, NORTH CAROLINA

Hydraulic Properties	USGS Phase I Study ⁽¹⁾	USGS Aquifer Test ⁽²⁾	ESE, Inc. ⁽³⁾	DEHNR Aquifer Test ⁽⁴⁾	RASA Estimate ⁽⁵⁾
Aquifer transmissivity (cubic foot per day per square foot times foot of aquifer thickness)	4,300 to 24,500 average 9,500	1,140 to 1,325	820 to 1,740 average 1,280	900	10,140 to 26,000
Aquifer hydraulic conductivity (foot per day)	14 to 82 average 35	20 to 60	--	18 to 91 average 54	45 to 80 average 65
Aquifer storage coefficient (dimensionless)	--	0.0002 to 0.00022	0.0005 to 0.001 average 0.0008	0.0019	--
Confining-unit vertical hydraulic conductivity (foot per day)	--	0.03 to 0.41	0.0014 to 0.051 average 0.0035	--	--

Note:

- ⁽¹⁾ Analysis of specific capacity data from Harned and others (1989).
- ⁽²⁾ Aquifer test at well HP-708.
- ⁽³⁾ Aquifer test at Hadnot Point well HP-462 from Environmental Sciences and Engineering, Inc. (1988).
- ⁽⁴⁾ Unpublished aquifer test data at well X24s2x, from DEHNR well records (1985).
- ⁽⁵⁾ Transmissivities based on range of aquifer thickness and average hydraulic conductivity from Winner and Coble (1989).

Source: Cardinell, et al., 1993.

TABLE 1-4

**PROTECTED SPECIES WITHIN MCB, CAMP LEJEUNE
REMEDIAL INVESTIGATION, CTO-0303
MCAS, NEW RIVER, NORTH CAROLINA**

Species	Protected Classification
Animals:	
American alligator (<i>Alligator mississippiensis</i>)	SC
Bachmans sparrow (<i>Aimophila aestivalis</i>)	FCan, SC
Green (Atlantic) turtle (<i>Chelonia m. mydas</i>)	T(f), T(s)
Loggerhead turtle (<i>Caretta caretta</i>)	T(f), T(s)
Peregrine falcon (<i>Falco peregrinus</i>)	E(f), E(s)
Piping plover (<i>Charadrius melodus</i>)	T(f), T(s)
Red-cockaded woodpecker (<i>Picoides borealis</i>)	E(f), E(s)
Southern Hognose Snake (<i>Heterodon simus</i>)	FCan, SR
Diamondback Terrapin (<i>Malaclemys terrapin</i>)	FCan, SC
Carolina Gopher Frog (<i>Rana capito capito</i>)	FCan, SC
Cooper's Hawk (<i>Accipiter cooperii</i>)	SC
Eastern Diamondback Rattlesnake (<i>Crotalus adamanteus</i>)	SR
Eastern Coral Snake (<i>Micrurus fulvius</i>)	SR
Pigmy Rattlesnake (<i>Sistrurus miliarius</i>)	SR
Black Bear (<i>Ursus americanus</i>)	SR
Plants:	
Rough-leaf loosestrife (<i>Lysimachia asperulifolia</i>)	E(f), E(s)
Seabeach Amaranth (<i>Amaranthus pumilus</i>)	T(f), T(s)
Chapman's Sedge (<i>Carex chapmanii</i>)	FCan
Hirst's Witchgrass (<i>Dichanthelium</i> sp.)	FCan
Pondspice (<i>Litsea aestivalis</i>)	FCan
Boykin's Lobelia (<i>Lobelia boykinii</i>)	FCan
Loose Watermilfoil (<i>Myriophyllum laxum</i>)	FCan, T(s)
Awned Meadowbeauty (<i>Rhexia aristosa</i>)	FCan, T(s)
Carolina Goldenrod (<i>Solidago pulchra</i>)	FCan, E(s)
Carolina Asphodel (<i>Tofieldia glabra</i>)	FCan
Venus Flytrap (<i>Dionaea muscipula</i>)	FCan
Flaxleaf Gerardia (<i>Agalinis linifolia</i>)	SR
Pinebarrens Goober Grass (<i>Amphicarpum purshii</i>)	SR
Longleaf Three-awn (<i>Aristida palustris</i>)	SR
Pinebarrens Sandreed (<i>Calamovilfa brevipilis</i>)	E(s)
Warty Sedge (<i>Carex verrucosa</i>)	SR
Smooth Sawgrass (<i>Cladium mariscoides</i>)	SR
Leconte's Flatsedge (<i>Cyperus lecontei</i>)	SR
Erectleaf Witchgrass (<i>Dichanthelium erectifolium</i>)	SR
Horsetail Spikerush (<i>Eleocharis equisetoides</i>)	SR
Sand Spikerush (<i>Eleocharis montevidensis</i>)	SR

TABLE 1-4 (Continued)

PROTECTED SPECIES WITHIN MCB, CAMP LEJEUNE
 REMEDIAL INVESTIGATION, CTO-0303
 MCB, CAMP LEJEUNE, NORTH CAROLINA

Species	Protected Classification
Flaxleaf Seedbox (<i>Ludwigia linifolia</i>)	SR
Torrey's Muhley (<i>Muhlenbergia torreyana</i>)	E(s)
Southeastern Panic Grass (<i>Panicum tenerum</i>)	SR
Spoonflower (<i>Peltandra sagittifolia</i>)	SR
Shadow-witch (<i>Ponthieva racemosa</i>)	SR
West Indies Meadowbeauty (<i>Rhexia cubensis</i>)	SR
Pale Beakrush (<i>Rhynchospora pallida</i>)	SR
Longbeak Baldsedge (<i>Rhynchospora scirpoides</i>)	SR
Tracy's Beakrush (<i>Rhynchospora tracyi</i>)	SR
Canby's Bulrush (<i>Scirpus tuberculatus</i>)	SR
Slender Nutrush (<i>Scleria minor</i>)	SR
Lejeune Goldenrod (<i>Solidago</i> sp.)	SR
Dwarf Bladderwort (<i>Utricularia olivacea</i>)	T(s)
Elliott's Yellow-eyed Grass (<i>Xyris elliotii</i>)	SR
Carolina Dropseed (<i>Sporobolus</i> sp.)	T(s)

Legend:

- E(f) = Federal Endangered
- T(f) = Federal Threatened
- Fcan = Candidate for Federal Listing
- E(s) = State Endangered
- T(s) = State Threatened
- SC = State Special Concern
- SR = State Rare

Source: LeBlond, 1994

TABLE 1-5

LAND UTILIZATION WITHIN DEVELOPED AREAS OF MCB, CAMP LEJEUNE
 REMEDIAL INVESTIGATION, CTO-0303
 MCAS, NEW RIVER, NORTH CAROLINA

Geographic Area	Operation	Training (Instruc.)	Maintenance	Supply/ Storage	Medical	Admin- istration	Family Housing	Troop Housing	CM	CO	Recreation	Utility	Total
Hadnot Point	31 (2.9)	15 (1.4)	154 (14.3)	157 (14.4)	10 (0.9)	122 (11.3)	22 (2.0)	196 (18.1)	115 (10.7)	36 (3.3)	182 (16.9)	40 (3.7)	1,080 (100)
Paradise Point	1 (0)		3 (0.4)	1 (0)			343 (34)	19 (1.9)	31 (3.1)		610 (60.4)	2 (0.2)	1,010 (100)
Berkeley Manor/ Watkins							406 (80)		41 (8.1)	1 (0.2)	57 (11.2)	2 (0.5)	507 (100)
Midway Park		1 (0.4)		2 (0.7)		2 (0.7)	248 (92.2)		8 (3.0)	3 (1.1)	4 (1.5)	1 (0.4)	269 (100)
Tarawa Terrace I and II			3 (0.5)			1 (0.3)	428 (77.4)		55 (9.9)	11 (2.0)	47 (8.5)	8 (1.4)	553 (100)
Knox Trailer							57 (100)						
French Creek	8 (1.4)	1 (0.2)	74 (12.7)	266 (45.6)	3 (0.5)	7 (1.2)		122 (20.9)	22 (3.8)	6 (1.0)	74 (12.7)		583 (100)
Courthouse Bay		73 (28.6)	28 (10.9)	14 (5.5)		12 (4.7)	12 (4.7)	43 (16.9)	15 (5.9)	4 (1.6)	43 (16.9)	11 (4.3)	255 (100)
Onslow Beach	6 (9.8)	1 (1.6)	3 (4.8)	2 (3.2)	1 (1.6)	2 (3.2)		2 (3.2)	12 (19.3)		25 (40.3)	8 (13.0)	62 (100)
Rifle Range		1 (1.3)	1 (1.3)	7 (8.8)	1 (1.3)	5 (6.3)	7 (8.8)	30 (37.5)	5 (6.3)	1 (1.3)	9 (11.3)	13 (16.3)	80 (100)
Camp Geiger	4 (1.9)	15 (6.9)	19 (8.8)	50 (23.1)		23 (10.6)		54 (25.0)	27 (12.5)	2 (1.0)	16 (7.4)	6 (2.8)	216 (100)
Montford Point	6 (2.6)	48 (20.5)	2 (0.9)	4 (1.7)	2 (0.9)	9 (3.9)		82 (35.2)	20 (8.6)	1 (0.4)	49 (21.0)	10 (4.3)	233 (100)
Base-Wide Misc.	1 (0.8)			87 (68.0)		3 (2.3)			19 (14.8)			18 (14.1)	128 (100)
TOTAL	57 (1.)	155 (3.1)	287 (5.7)	590 (11.7)	17 (0.38)	186 (3.7)	1,523 (30.2)	548 (10.8)	370 (7.4)	65 (1.3)	1,116 (22.2)	119 (2.4)	5,033 (100)

Notes:

Numbers without parentheses represent total acres.
 Numbers within parentheses represent percentage of total acres.
 Source: Master Plan, 1988

TABLE 1-6

CLIMATIC DATA SUMMARY
 MARINE CORPS AIR STATION, NEW RIVER
 REMEDIAL INVESTIGATION, CTO-0303
 MCAS, NEW RIVER, NORTH CAROLINA

	Precipitation (Inches)			Relative Humidity (Percent)	Temperature (Fahrenheit)			Mean Number of Days With				
	Maximum	Minimum	Average		Maximum	Minimum	Average	Precipitation		Temperature		
								>=0.01"	>=0.5"	>=90F	>=75F	<=32F
January	7.5	1.4	4.0	79	54	34	44	11	2	0	1	16
February	9.1	.9	3.9	78	57	36	47	10	3	0	2	11
March	8	.8	3.9	80	64	43	54	10	3	*	5	5
April	8.8	.5	3.1	79	73	51	62	8	2	1	13	*
May	8.4	.6	4.0	83	80	60	70	10	3	2	25	0
June	11.8	2.2	5.2	84	86	67	77	10	4	7	29	0
July	14.3	4.0	7.7	86	89	72	80	14	5	13	31	0
August	12.6	1.7	6.2	89	88	71	80	12	4	11	31	0
September	12.8	.8	4.6	89	83	66	75	9	3	4	27	0
October	8.9	.6	2.9	86	75	54	65	7	2	*	17	*
November	6.7	.6	3.2	83	67	45	56	8	2	0	7	3
December	6.6	.4	3.7	81	58	37	48	9	2	0	2	12
Annual	65.9	38.2	52.4	83	73	53	63	118	35	39	189	48

Note:

* = Mean no. of days less than 0.5 days

Source: Naval Oceanography Command Detachment, Asheville, North Carolina. Measurements obtained from January 1955 to December 1990.

TABLE 1-7

**SUMMARY OF WELL CONSTRUCTION DETAILS
CONFIRMATION STUDY
SITE 54, CRASH CREW FIRE TRAINING BURN PIT
REMEDIAL INVESTIGATION, CTO-0303
MCAS, NEW RIVER, NORTH CAROLINA**

Well No.	Date Installed	Top of PVC Casing Elevation (feet, above msl) ⁽¹⁾	Ground Surface Elevation (feet, above msl)	Boring Depth (feet, below ground surface) ⁽²⁾	Well Depth (feet, below ground surface) ⁽²⁾	Screen Interval Depth (feet, below ground surface) ⁽²⁾	Sand Pack Interval Depth (feet, below ground surface)	Bentonite Interval Depth (feet, below ground surface)
54-GW01	7/84	20.39	20.72	≈30	≈29	≈14-29	NA	NA
54-GW02	12/86	23.83	20.91	≈29	≈28	≈13-28	NA	NA
54-GW03	12/86	13.38	10.91	≈39	≈38	≈23-38	NA	NA

Notes:

⁽¹⁾ msl = mean sea level

⁽²⁾ Measurements were taken off geologic cross section of Site 54

Horizontal positions are referenced to N.C. State Plane Coordinate System (NAD 27) CF = 0.9999216 from USMC Monument Toney.

Vertical datum NGVD 29.

NA - Not Applicable

TABLE 1-8

DETECTED TARGET CONTAMINANTS IN GROUNDWATER
 CONFIRMATION STUDY
 SITE 54, CRASH CREW FIRE TRAINING BURN PIT
 REMEDIAL INVESTIGATION, CTO-0303
 MCAS, NEW RIVER, NORTH CAROLINA

Sample Number: Date Sampled:	Standards		54-GW01 7/16/84	54-GW01 12/11/86	Supply Well 5009 7/16/84	54-GW02 12/10/86	54-GW02 3/5/87	54-GW03 12/10/86	54-GW03 3/05/87
	NCWQS ⁽¹⁾	MCL ⁽²⁾							
Parameter: Units (µg/L)									
Chromium	50	100	60	10.7	ND	67.9	28	23.9	32
Chromium (+6)	--	--	NA	ND	NA	14.6	45.9	ND	12.1
Lead	15 ⁽³⁾	15 ⁽³⁾	ND	ND	ND	ND	27	ND	ND
Oil & Grease	--	--	1,000	3,000	ND	ND	1,000	2,000	2,000
Total Phenols	--	--	3	4	2	ND	ND	6	ND

Notes:

Concentrations reported in micrograms per liter (µg/L); or parts per billion (ppb).

NA - Not analyzed.

ND - Not detected.

⁽¹⁾ NCWQS - North Carolina Water Quality Standards for groundwater.

⁽²⁾ Federal maximum contaminant levels (MCLs) established under the Safe Drinking Water Act of 1986.

⁽³⁾ Health Advisories (USEPA, 1993), values represent lifetime exposures, except for arsenic and beryllium which represents a 10-04 lifetime risk.

Source: ESE, Site Summary Report, Final. September, 1990.

TABLE 1-9

**DETECTED TARGET CONTAMINANTS IN SEDIMENT
SITE 54, CRASH CREW FIRE TRAINING BURN PIT
REMEDIAL INVESTIGATION, CTO-0303
MCAS, NEW RIVER, NORTH CAROLINA**

Sample Number Sample Depth (feet)			
Parameter: Units (mg/kg)	54-SE01 12/10/86	54-SE02 12/10/86	54-SE03 12/10/86
Chromium	19.3	6.45	6.48
Lead	28.2	9.36	ND
Oil & Grease	998	884	1,560
Total Phenols	0.443	0.334	2.01

Notes:

Concentrations reported in milligrams per kilogram (mg/kg); or parts per million (ppm).
ND = Not Detected.

Source: ESE, Site Summary Report, Final. September, 1990.

TABLE 1-10

**REMEDIAL INVESTIGATION OBJECTIVES
SITE 54, CRASH CREW FIRE TRAINING BURN PIT
REMEDIAL INVESTIGATION, CTO-0303
MCAS, NEW RIVER, NORTH CAROLINA**

Medium or Area of Concern	RI/FS Objective	Criteria for Meeting Objective	Proposed Investigation/Study
1. Soil	1a. Assess the extent of soil contamination within the burn pit area, and suspected spill area.	Characterize contaminant levels in surface and subsurface soils adjacent to the burn pit, and suspected spill area.	Soil Investigation
	1b. Assess human health and ecological risks associated with exposure to surface soils at Site 54.	Characterize contaminant levels in surface soils at Site 54.	Soil Investigation Risk Assessment
2. Groundwater	2a. Determine whether contamination from soils is migrating to groundwater.	Characterize subsurface soil and leaching potential. Characterize shallow groundwater.	Groundwater Investigation
	2b. Assess health risks posed by potential future usage of the shallow groundwater.	Evaluate groundwater quality and compare to groundwater criteria and risk-based action levels.	Groundwater Investigation Risk Assessment
	2c. Assess nature and extent of shallow groundwater contamination.	Characterize shallow groundwater quality.	Groundwater Investigation
	2d. Define hydrogeologic characteristics for fate and transport evaluation and remedial technology evaluation, if required.	Estimate hydrogeologic characteristics of the shallow aquifer (flow direction, transmissivity, permeability, etc.).	Groundwater Investigation
3. Drainage Ditches	3a. Assess human health and ecological risks associated with exposure to soils and surface water runoff from drainage ditches.	Characterize nature and extent of contamination in soil and surface water runoff.	Drainage Ditch Investigation

SECTION 1.0 FIGURES

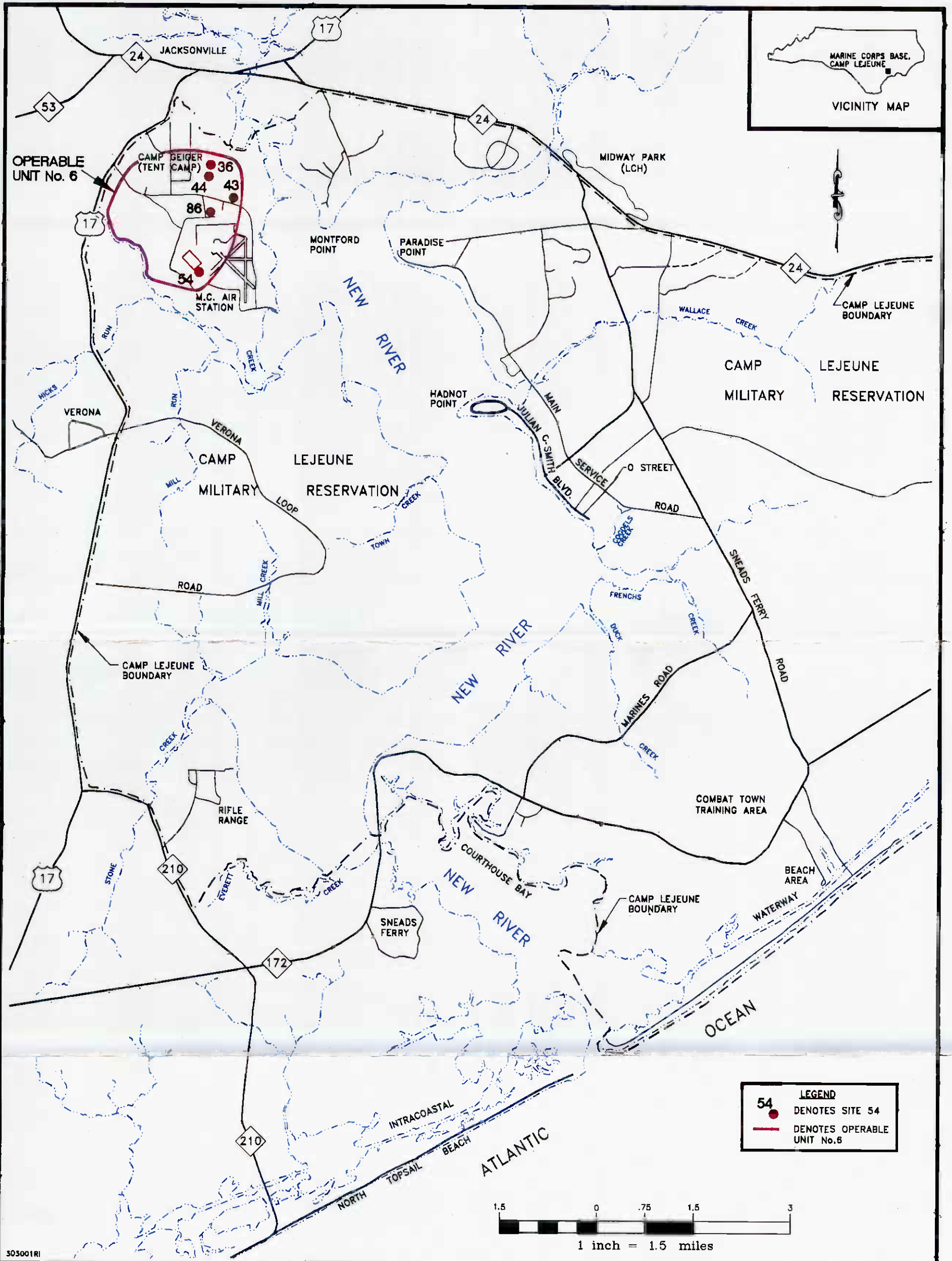


FIGURE 1-1
 OPERABLE UNIT No. 6 - SITES 36, 43, 44, 54, AND 86
 REMEDIAL INVESTIGATION, CTO-0303

MARINE CORPS AIR STATION, NEW RIVER
 NORTH CAROLINA

01717AABIY

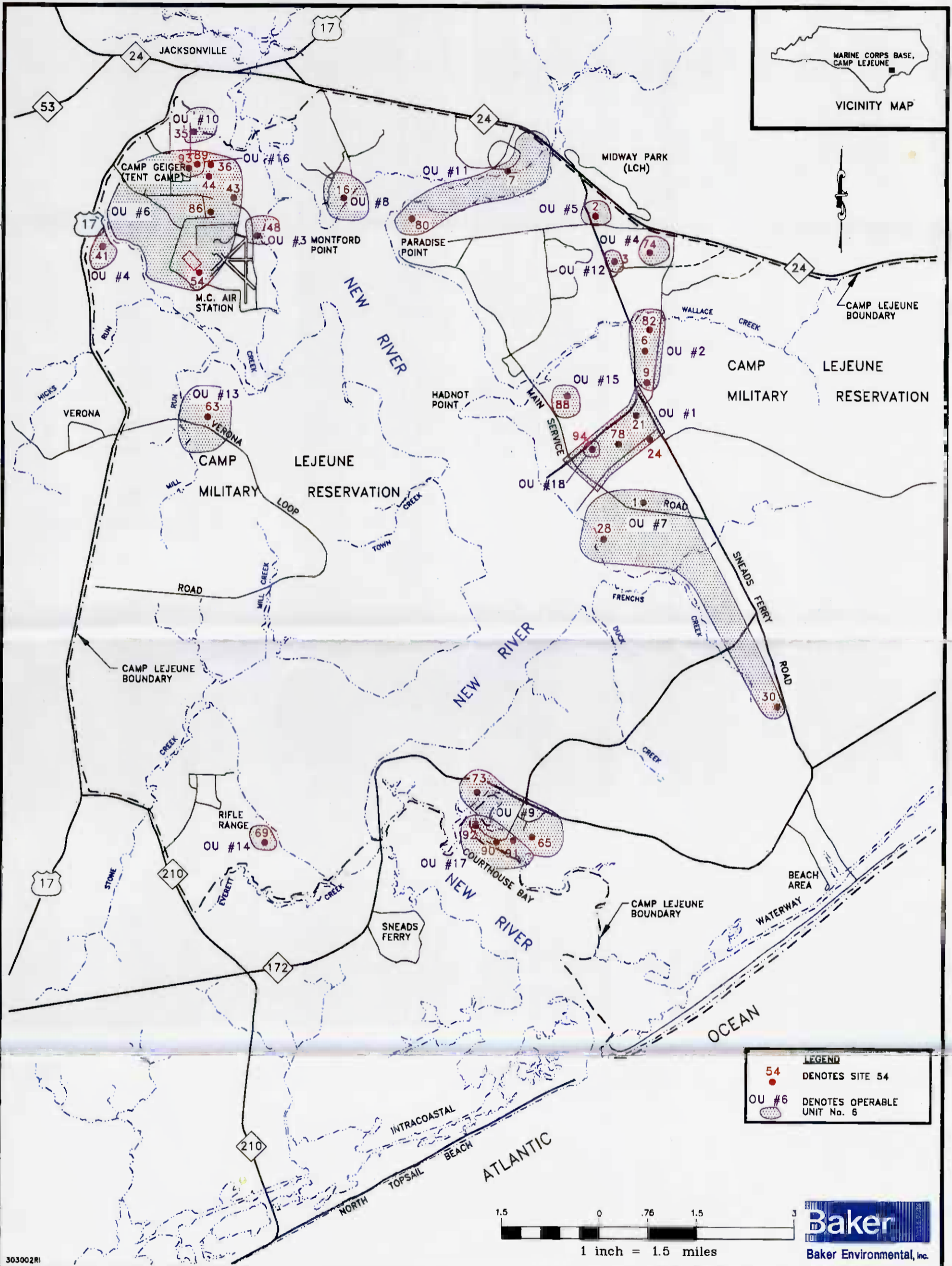


FIGURE 1-2
OPERABLE UNIT AND SITE LOCATIONS
REMEDIAL INVESTIGATION, CTO-0303

MARINE CORPS BASE, CAMP LEJEUNE
NORTH CAROLINA

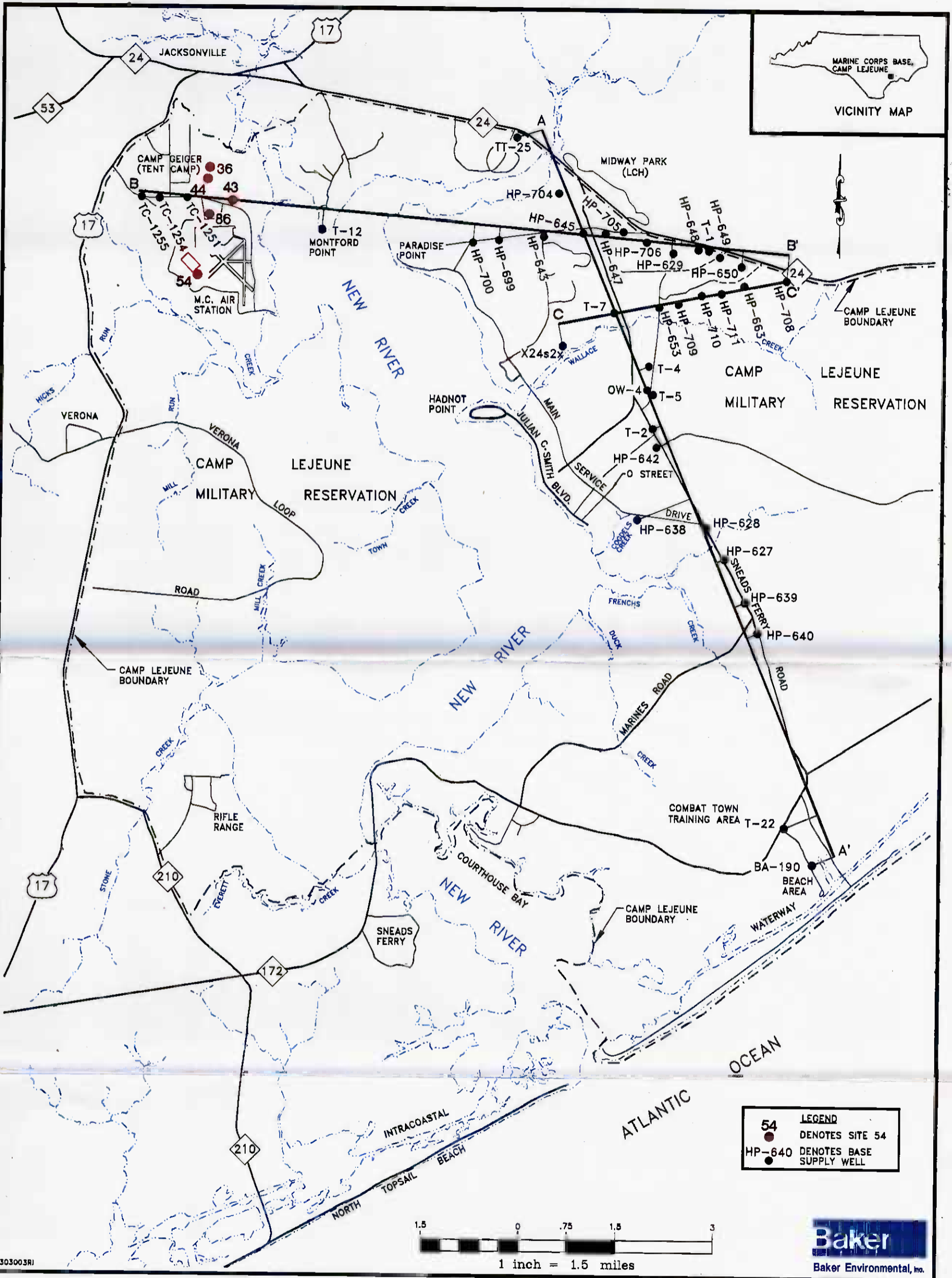


FIGURE 1-3
 LOCATIONS OF HYDROGEOLOGIC CROSS-SECTIONS
 REMEDIAL INVESTIGATION, CTO-0303

MARINE CORPS AIR STATION, NEW RIVER
 NORTH CAROLINA

303003R1
 SOURCE: DEPT. OF INTERIOR,
 WATER-RESOURCES INVESTIGATIONS
 REPORT, 89-409B, PLATE 4

Baker
 Baker Environmental, Inc.

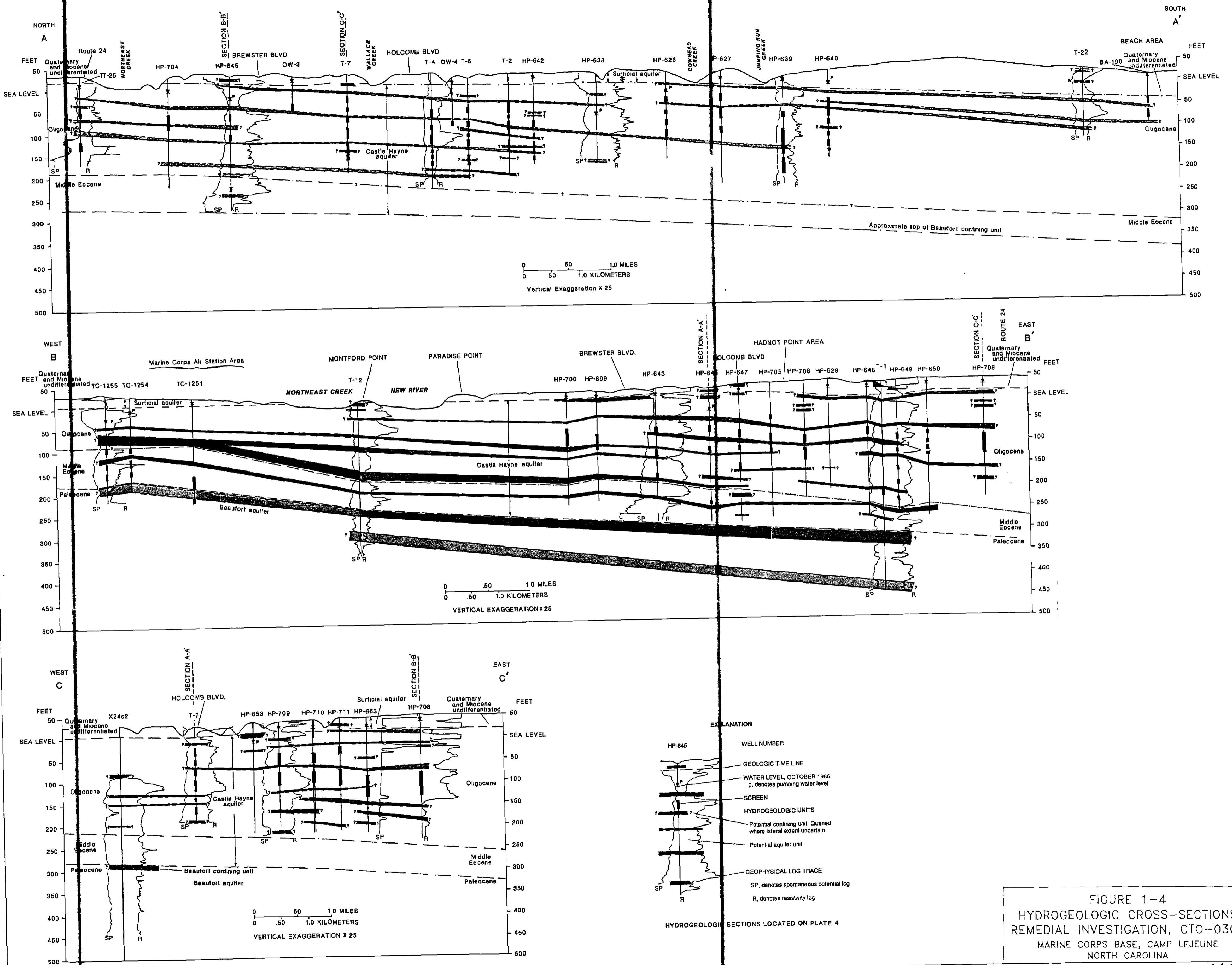
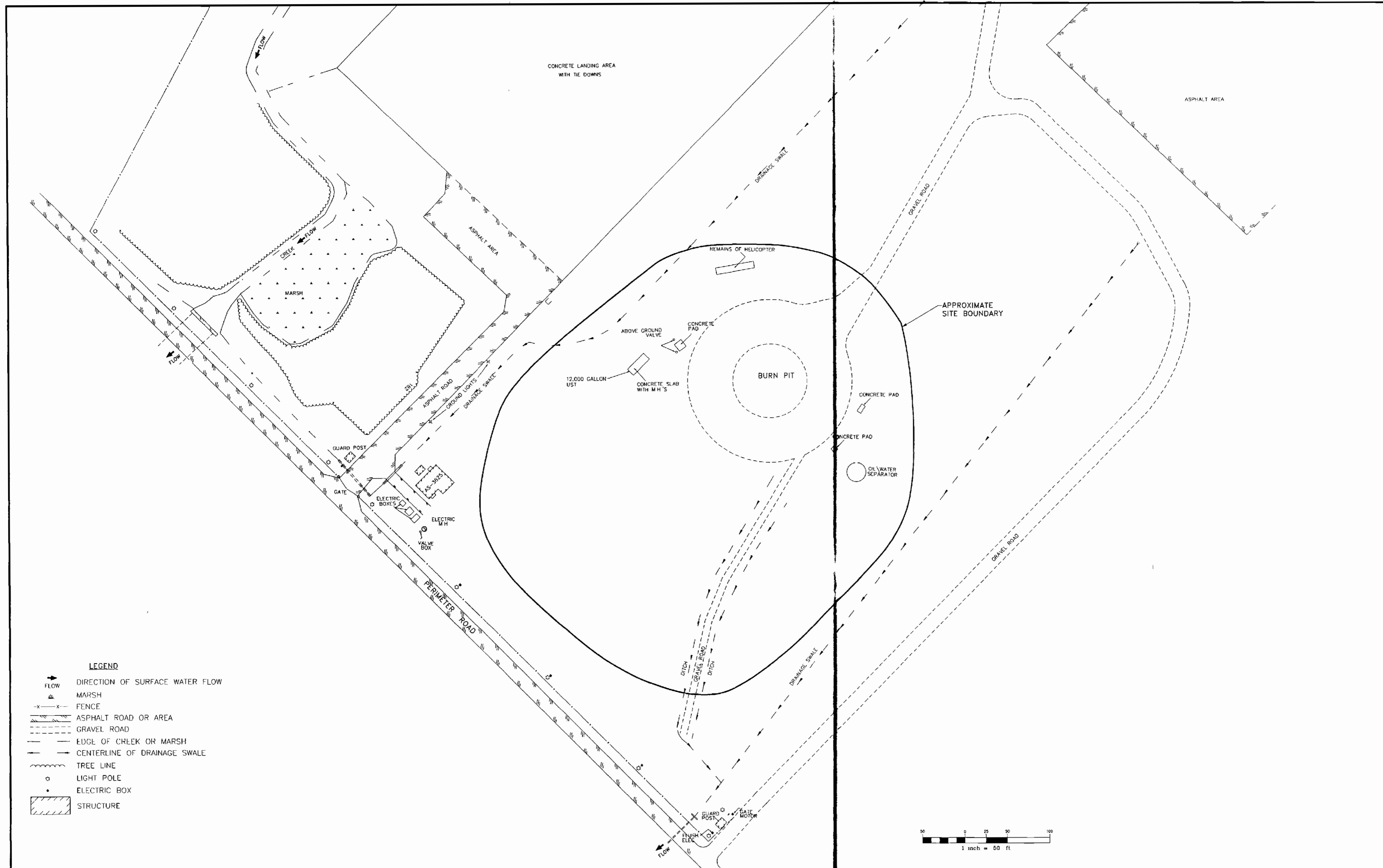


FIGURE 1-4
HYDROGEOLOGIC CROSS-SECTIONS
REMEDIAL INVESTIGATION, CTO-0303
MARINE CORPS BASE, CAMP LEJEUNE
NORTH CAROLINA

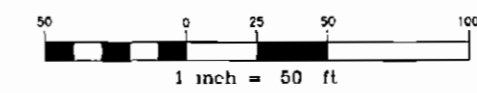
HYDROGEOLOGIC SECTIONS A-A', B-B', AND C-C' AT CAMP LEJEUNE, NORTH CAROLINA

0177AAB2X



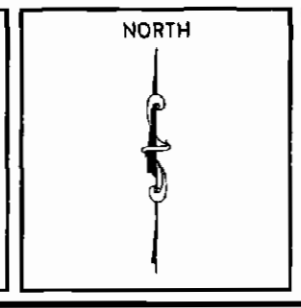
LEGEND

- FLOW DIRECTION OF SURFACE WATER FLOW
- MARSH
- FENCE
- ASPHALT ROAD OR AREA
- GRAVEL ROAD
- EDGE OF CREEK OR MARSH
- CENTERLINE OF DRAINAGE SWALE
- TREE LINE
- LIGHT POLE
- ELECTRIC BOX
- STRUCTURE



REVISIONS	
SOURCE	LANTJIV, FEBRUARY 1992 SURVEY BRENT A. LANIER AND ASSOCIATES, 1995

DRAWN	REL
REVIEWED	TFT/JLZ
S.O.#	303-0000-07000
CADD#	303007RI



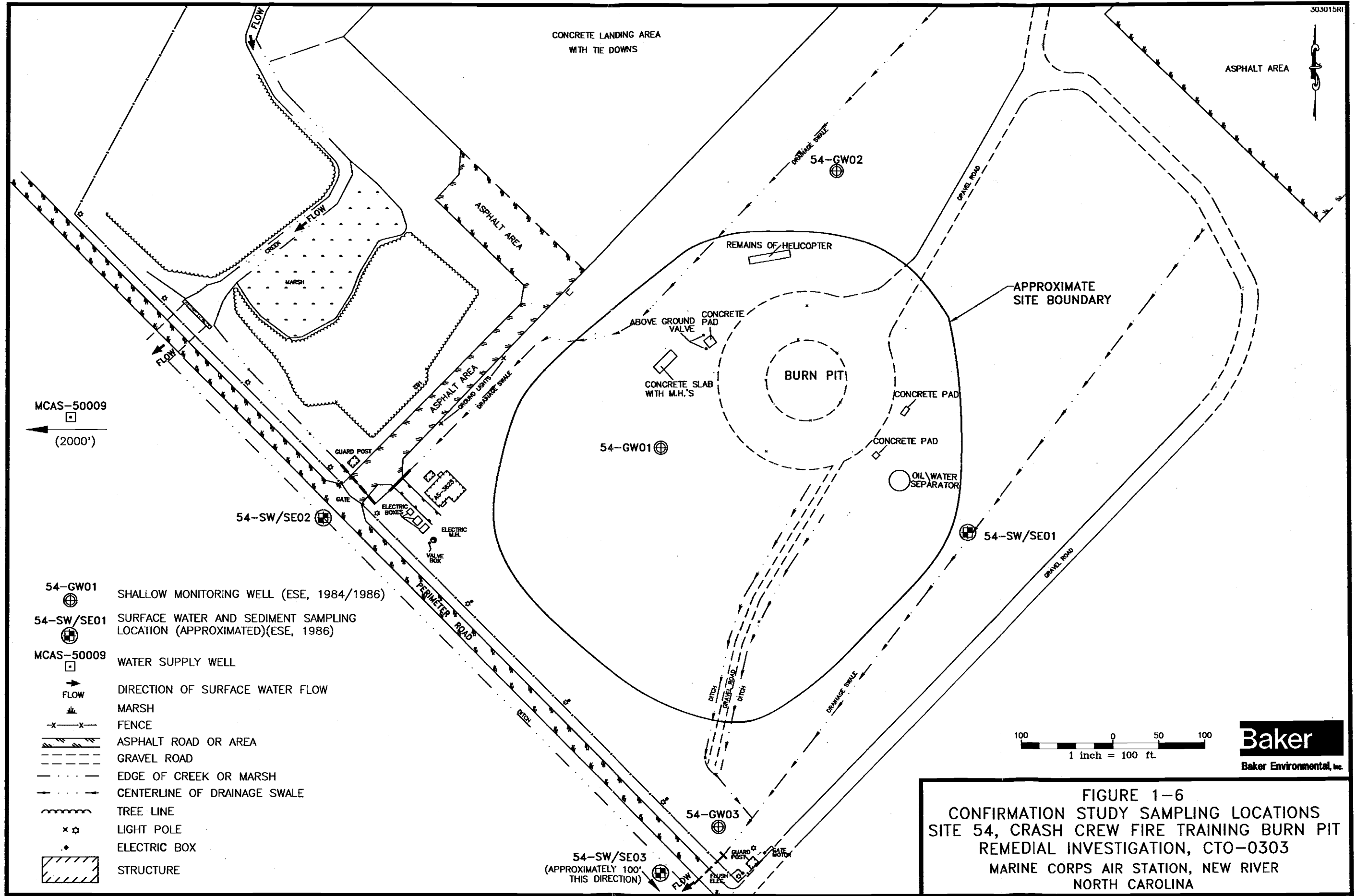
REMEDIAL INVESTIGATION CTO-0303
 MARINE CORPS AIR STATION, NEW RIVER
 NORTH CAROLINA
 BAKER ENVIRONMENTAL, Inc
 Coraopolis, Pennsylvania



SITE MAP SITE 54 CRASH CREW FIRE TRAINING BURN PIT	
SCALE	1" = 50'
DATE	JANUARY 1995

FIGURE No.
1-5

03/15/96 07:14:14 (PLOT) K:\VENDOR\DEFAULT\TBS K:\152007RI\303007RI.DWG



MCAS-50009
 (2000')

- 54-GW01 SHALLOW MONITORING WELL (ESE, 1984/1986)
- 54-SW/SE01 SURFACE WATER AND SEDIMENT SAMPLING LOCATION (APPROXIMATED)(ESE, 1986)
- MCAS-50009 WATER SUPPLY WELL
- FLOW DIRECTION OF SURFACE WATER FLOW
- MARSH
- FENCE
- ASPHALT ROAD OR AREA
- GRAVEL ROAD
- EDGE OF CREEK OR MARSH
- CENTERLINE OF DRAINAGE SWALE
- TREE LINE
- LIGHT POLE
- ELECTRIC BOX
- STRUCTURE

100 0 50 100
 1 inch = 100 ft.

Baker
 Baker Environmental, Inc.

FIGURE 1-6
 CONFIRMATION STUDY SAMPLING LOCATIONS
 SITE 54, CRASH CREW FIRE TRAINING BURN PIT
 REMEDIAL INVESTIGATION, CTO-0303
 MARINE CORPS AIR STATION, NEW RIVER
 NORTH CAROLINA

01717AA01Z

2.0 SITE CHARACTERISTICS

Section 2.0 of this report presents information on site-specific physical characteristics. This section includes a discussion on the topography, surface water hydrology and drainage features, soil, geology, hydrogeology, and ecology.

2.1 Topography and Surface Features

Site 54 is a fire response training area for MCAS New River. The area contains an asphalt-lined burn pit used to stage fuel fires (Figure 2-1). The pit is approximately 90 feet in diameter. Three compacted gravel roads lead to and/or around the burn pit. An oil/water separator and one underground storage tank are located on the site. The burn pit is situated on the crest of a gently-sloping rise. The burn pit area has an approximate elevation of 21 feet above mean sea level (msl). The site slopes to the west, toward an unnamed tributary of Southwest Creek (approximately 9 feet msl) and to the southwest, toward Perimeter Road (approximately 11 feet msl). The slopes are generally grassy.

2.2 Surface Water Hydrology

Drainage across the site is controlled. Four subparallel swales run northeast-southwest across Site 54. The two outer of the swales bound the site to the east and west. The third and fourth swales lie between the two, on either side of a gravel access road. These swales originate at the burn pit gravel road, and empty in the eastern swale near perimeter road. This swale collects run-off from the burn pit area. The two outer swales collect runoff from the areas surrounding the burn pit. All the swales lead to tributaries of Southwestern Creek. During the time of the investigation, none of the swales contained water.

2.3 Soil

According to the Soil Conservation Service (SCS) Soil Survey of Camp Lejeune, North Carolina (1984), a single unit lies under Site 54, the Baymeade (BaB) soil complex. The Baymeade complex is typically found in areas where the original soil has been cut, filled, or graded. Soil properties of this unit have been altered through slope modification and smoothing. Generally, Baymeade soils are moderately to strongly acidic and are classified under the SCS as fine sand and loamy fine sand (SM-SP). Table 2-1 provides a summary of soil physical properties found at Site 54.

2.4 Geology

A consistent depositional sequence was observed in borings throughout Site 54. Borings and wells completed in the uppermost formation (Figure 1-1) indicated sediments consistent with information obtained from the U.S. Geological Survey's hydrogeologic assessment of Camp Lejeune (Cardinell, et. al. 1993). Cardinell identifies this unit as the undifferentiated formation.

The undifferentiated formation at Site 54, consists of several units of Holocene and Pleistocene ages. The upper 2 feet of soil appears to be fill or reworked soil, particularly in the area around the burn pit. Compacted layers of gravel, sand, silt, and/or clay were observed. Otherwise, a predominantly silty fine sand or silt is present at the surface. Sediments of the undifferentiated formation tend to coarsen with depth, and are generally medium dense. Thin, discontinuous lenses of clay, and clay and silt are scattered throughout the undifferentiated formation, and are very soft to soft.

Geologic cross-sections depicting shallow soil lithologies were developed based on soils collected during the RI. Soil boring records are present in Appendix A, and well construction records in Appendix B. Figure 2-1 shows the location of the cross-sections traversing Site 54 and Figure 2-2 depicts the lithologies.

Cross-section A-A' is located south of the burn pit and traverses west to east. Sand is predominant in this section and generally coarsens with depth. Silty clay and clay lenses are evident in 54-GW04, 54-GW05, and 54-GW08. Groundwater generally occurs in the fine- to medium-sands. Groundwater is generally first encountered in the fine to medium sands.

Cross-section B-B' is located east of the burn pit and traverses north to south. Sand is predominant in this section and generally coarsens with depth. Partially lithofied fossiliferous limestone is present in 54-GW07. Groundwater is first encountered in the silty fine sands.

Cross-section C-C' is located west of the burn pit and traverses north to south. Sand is predominant in this section and coarsens with depths. The fine to medium and fine to coarse sands tend to thin toward either end of the section. A clay lens extends across the length of the section, and appears to thin out toward the northern end of this section. Groundwater occurs in the fine to medium and fine to coarse sands.

Cross-section D-D' is located immediately west and south of the burn pit and traverses northwest to southeast. Sand is predominant in this section and generally coarsens with depth. Groundwater occurs in the fine to medium and fine to coarse sands.

2.5 Hydrogeology

There are several aquifers beneath Site 54 and vicinity. The upper surficial aquifer was investigated at this site. The surficial aquifer occurs within the sediments of the undifferentiated formation, typically within 10 feet of the surface.

Hydrogeologic conditions were evaluated by installing borings, and permanent and temporary wells screened in the undifferentiated formation/surficial aquifer. Wells 54-GW07 and 54-GW08 are 5 to 10 deeper than the other wells.

2.5.1 Groundwater Elevation Data

Groundwater and surface water elevation data for Site 54 are summarized on Table 2-2. Four rounds of groundwater level measurements were collected in March, April, May, and August of 1995. However, four rounds of groundwater level measurements are not available for all wells because of the timing of the well installation.

The shallow monitoring wells average a depth of approximately 15 feet bgs and are screened to intercept the first water-bearing zone. The deeper wells have an average depth of approximately 30 feet bgs, and monitor a deeper portion of the surficial aquifer.

The groundwater and surface water elevations data generally exhibit a downward trend between March and August, 1995 (Figure 2-3A and B). The decrease in elevation is between 1 and 1.5 feet. This data trend is likely attributable to a lack of precipitation during the time period. Between May and August the groundwater elevation data from wells 54-GW03 and 54-GW08 exhibit a slight

upward trend. The increase is approximately 0.25 feet at 54-GW03, and 0.1 feet at 54-GW08. The reason for the groundwater elevation increases in these two wells is not clear since no site-wide trend or pattern is evident. Because the increase is relatively minimal, it may be attributed to normal groundwater fluctuations.

While there are no well nests at Site 54, 54-GW01 (surficial aquifer) is in close proximity to 54-GW08 and is screened approximately 15 feet higher than 54-GW08 (center to center). A comparison of the groundwater elevation data (Table 2-2) indicates that the elevation at 54-GW01 is consistently higher than 54-GW08. This difference indicates that a downward groundwater flow component probably exists.

2.5.2 Groundwater Flow Contour Maps

Groundwater elevation contour maps were developed from static water level data collected between March and August of 1995. Groundwater flow patterns were similar for all four months (as evidence by the similar changes to groundwater elevations shown on Figure 2-3A and 2-3B). Since the patterns are similar, contour maps using only the May 1995 data are presented because groundwater data was collected from all the well locations at this time. The contour maps are presented as Figures 2-4 and 2-5 for the shallow and deep surficial aquifer, respectively. Flow gradients were determined by dividing a certain distance of a flow line (or distance between two wells) into the change in groundwater elevation over that distance. The gradient may vary slightly from month to month due to changing groundwater elevations.

Shallow and deep groundwater flow in the surficial aquifer follows the site topography. Surficial groundwater has a component of flow to the west and southwest toward the unnamed tributary of Southwest Creek. The groundwater flow gradient across the site is 0.006 to 0.0009 feet/foot vertical to horizontal.

A vertical groundwater flow was determined between wells 54-GW01 and 54-GW08. This gradient was determined by dividing the distance between the well screen midpoints into the change in the groundwater elevation. The vertical gradient was approximately 0.17 feet/foot horizontal to vertical.

2.5.3 Hydraulic Properties

Rising and falling head slug tests were conducted at Site 54 on several monitoring wells. The slug test data were analyzed using the Bower-Rice method on AQTESOLV Version 2.0 software. The solutions are presented in Appendix N and are summarized on Table 2-3.

Rising head test data is used in the text discussions. Falling head test data was used where available as a check against the rising head data. The falling head test is equally valid to the rising head when the static water level is above the screen interval. Transmissivity is determined by multiplying the hydraulic conductivity by the saturated thickness of the aquifer. Transmissivity values for wells

The sediments of the surficial aquifer vary in composition, resulting in non-uniform hydraulic conductivities. The hydraulic conductivities of the surficial aquifer range from 8.2 feet/day at 54-GW03 and 50.5 feet/day at 54-GW06. The highest hydraulic conductivity, measured at 54-GW06, is associated with fine to coarse sand. Transmissivity values ranged from 505 feet²/day at 54-GW06 to 9,340 feet²/day at 54-GW08. The presence of a laterally discontinuous clay layer in the vicinity

of well 54-GW06 has effectively thinned the surficial aquifer, accounting for the relatively low transmissivity value.

The average surficial aquifer hydraulic conductivity at Site 54 is on the same order of magnitude as the value presented by Cardinell. The average hydraulic conductivity value at Site 54, based on RI slug tests, is 26.3 feet/day, compared to 50 feet/day presented in Cardinell. The Cardinell value was estimated based on a general composition of fine sand, mixed with some silt and clay. The RI results at Site 54 are comparable to the results at other sites throughout MCB Camp Lejeune.

2.5.4 Groundwater Flow Velocities

Groundwater flow velocities can be estimated using a variation of Darcy's equations:

$$V = Ki/n_e$$

where; V = groundwater velocity (feet/day)
K = Hydraulic conductivity (feet/day)
i = horizontal gradient (feet/foot)
n_e = effective porosity

"K" values were determined from slug tests conducted at five wells (Table 2-3). Surficial aquifer hydraulic conductivity values ranged from 8.2 ft/day to 50.5 ft/day. Flow gradient values were determined by using groundwater contours (Section 2.5.3). An effective porosity value of 30% was used (Fetter, 1988), based on a silty sand composition. Velocity calculations are presented in Appendix O. Velocities may vary slightly from month to month due to changing gradients.

For the surficial aquifer, calculated groundwater flow velocities varied by one order of magnitude, ranging from 0.16 to 1.25 feet/day. The higher velocities at 54-GW06 and 54-GW08 are attributable to relatively high hydraulic conductivity of the fine to coarse sands observed at these wells.

2.5.5 General Groundwater Flow Patterns

Groundwater in the surficial aquifer at Site 54 flows toward a tributary west of the site with an average velocity of 0.45 feet per day. The unnamed tributary west of the site represents a groundwater flow boundary at Site 54. It is evident that groundwater discharges to the tributary based groundwater flow direction and on the elevation of the creek relative to groundwater elevations. Additionally, there appears to be a downward component of groundwater flow in the surficial aquifer, based on the groundwater elevation difference between wells 54-GW01 and 54-GW08.

2.6 Identification of Water Supply Wells

Potable water supply wells within a one-mile radius of the site were identified by reviewing the Wellhead Management Program Engineering Study (Geophex, Ltd., 1991). Five water supply wells were identified within the one-mile radius. Four of the five wells were reported to be operating. Table 2-4 summarizes some well construction details and Figure 2-6 shows the location of the supply wells.

According to Cardinell, groundwater in the Castle Hayne aquifer in the vicinity of the air station flows southeast, toward the New River. Data from supply wells, including those close to the site, were used to determine groundwater flow patterns. Under normal flow conditions Site 54 is downgradient of the supply wells. No evidence was observed to suggest that the water supply wells have altered natural groundwater flow.

Four of the five supply wells were sampled in 1992 (Greenhorne & O'Mara, 1992). Detected compounds are presented on Table 2-4. No organic compounds were detected in any of the wells listed, however, several inorganic analytes were detected.

The USEPA has established secondary maximum concentration limits (SMCLs) for several of the detected analytes. North Carolina has also established standards for several of the detected analytes. The USEPA SMCL for aluminum was exceeded in all wells sampled, except MCAS-131. The iron and TDS standards/SMCLs were exceeded in MCAS-131. The iron standard/SMCL was exceeded in MCAS 5009. The TDS standard/secondary MCL was exceeded in MCAS-4140.

Elevated levels of iron and aluminum are typical of groundwater at Camp Lejeune. These metals have been detected in other supply wells across Camp Lejeune, and in monitoring wells at other OU 6 sites.

2.7 Ecology

According to the National Wetlands Index (NWI) maps, no wetlands are present at Site 54. However, wetland vegetation was identified along the drainage swales at Site 54 during the habitat evaluation.

No sensitive environments were identified at any of the sites studied during this remedial investigation. No endangered species were noted during the habitat evaluation nor were endangered species referenced at any of the sites during the endangered species survey (LeBlond, 1994).

Most of the area around Site 54 is an open, flat field that is maintained as an airfield. Wetland habitat is present along drainage ditches that have been excavated across the field. Some of these ditches are approximately 2 feet deep. Mixed forest can be found along the side of the airfield and an open field is present across the road from the airfield. Figure 2-7 shows a biohabitat map of the Site 54 area.

The open area is dominated by grasses. No trees, shrubs, or vines, are present because the area is mowed. A variety of herbaceous annuals and perennials are mixed with the grasses. Species identified during the habitat evaluation include the following:

- Dandelion- Taraxacum officinale
- Quaker Ladies- Houstonia caerulea
- Wood Sorrel- Oxalis europaea
- Mouse-ear Chickweed- Cerastium vulgare
- Wild Onion- Allium vineale
- White Clover- Trifolium repens
- Blue-eyed Grass- Sisyrinchium mucronatum atlanticum
- Narrow-leaved Plantain- Plantago lanceolata
- Field Pansy- Viola kitaibeliana

- Lyre-leaved Sage- Salvia lyrata
- Vetch- Vicia sp.
- Thistle- Cirsium sp.
- Black Medic- Medicago lupulina
- Dwarf Dandelion- Krigi virginica
- Carolina Cranesbill- Geranium carolinianum

Field vegetation is replaced by wetland vegetation along the drainage ditches, which contained flowing water during the habitat evaluation. This wetland vegetation includes water pennywort (Hydrocotyl americana), water dock (Rumex orbiculatus), and vernal iris (Iris verna). Red fescue (Festuca rubra) is also found along the ditches. Large mats of an emergent, unidentified pondweed were also noted in the drainage ditches.

Mixed forest is present along the side of the airfield. While loblolly pine (Pinus taeda) is dominant in the canopy of this forest it is mixed with both upland and lowland species depending on the topography of specific locations within the forest. Species in the understory and on the forest floor also vary with the topography.

In the upland portions of the mixed forest pines are found with water oak (Quercus nigra), tulip poplar (Liriodendron tulipifera), southern red oak (Quercus falcata), white oak (Quercus alba), and beech (Fagus grandifolium). The white oak and beech are replaced by red maple (Acer rubrum), and ash (Fraxinus sp.) in the lower areas of the mixed forest. In the understory holly (Ilex opaca) and dogwood (Cornus florida) characterize the upland areas while tag alder (Alnus serrulata) is found in wetter areas. Myrtle (Myrica cerifera), juniper (Juniperus virginianus), and rosebay (Magnolia virginiana) are found throughout the mixed forest. Bullbriar (Smilax bona-nox), jasmine (Gelsemium sempervirens), and Japanese honeysuckle (Lonicera japonica) are also found throughout the mixed forest.

In the upland portions of the mixed forest, partridgeberry (Mitchella repens), heartleaf (Hexastylis arifolia), and beechdrops (Epifagus viryiniiana) are found while switch cane (Arundinaria tecta), sensitive fern (Onoclea sensibilis), arrow arum (Peltandra virginica), and giant cane (Arundinaria gigantea) are found in wetter areas. Yellow thistle (Cirsium horridulum) and bushy beard grass (Andropogon glomeratus) are found along the edges of the mixed forest.

Across the road from the airfield an overgrown field is present. Although large trees are growing in this field saplings of loblolly pine (Pinus taeda) and sweetgum (Liquidambar styraciflua) are mixed with shrubs of marsh elder (Ba frutescens). Dewberry (Rubus hispidus) is the only vine that was noted. The overgrown field is dominated by two species of grass, broom sedge (Andropogon virginianus) and bushy beard grass (Andropogon ylomeratus). Two forbs, dog fennel (Eupatorium capillifolium) and vetch (Vicia sp.) are mixed with the grasses.

Few birds were observed at Site 54, perhaps because so much of the area is covered by mowed field. Killdeer (Charadrius vociferus) and savannah sparrows (Passerculus sandwichensis) were noted on the field while catbirds (Dumetella carolinensis), carolina wrens (Thryothorus ludovicianus), and mourning doves (Zenaida macroura) were observed in the areas around the site.

Large numbers of whitetail deer (Odocoileus virginianus) feed in the open field, which was covered with deer tracks and droppings. Signs of squirrels (Sciurus sp.) were noted in the mixed forest. Green frogs (Rana clamitans) were observed in the drainage ditches in the open field and in wet

areas within the mixed forest. The drainage ditches also supported populations of small fish and freshwater snails.

2.8 References

Barnhill, W.L. 1984. Soil Survey of Camp Lejeune, North Carolina. USDA, Soil Conservation Service.

Cardinell, A.P., Berg, S.A., and Lloyd O.B. Jr. 1993. Hydrogeologic Framework of U.S. Marine Corps Base at Camp Lejeune, North Carolina. USGS. Water-Resources Investigations Report 93-4049.

Fetter, C.W. 1986. Applied Hydrogeology. Charles E. Merrill Publishing Co., Columbus, Ohio.

Geophex, Ltd. 1992. Wellhead Management Program Engineering Study 91-36. Prepared for Marine Corps Base, Camp Lejeune, North Carolina. January 22, 1992.

Greenhorne & O'Mara. 1992. Preliminary Draft Report Wellhead Monitoring Study. Prepared for the Department of the Navy, Civil Branch. December, 1992.

Harned, D.A., Lloyd, O.B., Jr., and Treece, M.W., Jr. 1989. Assessment of Hydrologic and Hydrogeologic Data at Camp Lejeune Marine Corps Base, North Carolina. USGS. Water-Resources Investigations Report 89-4096.

LeBlond, Richard. 1991. Critical Species List - Camp Lejeune Endangered Species and Special-Interest Communities Survey. Principal Investigator.

SECTION 2.0 TABLES

TABLE 2-1

SUMMARY OF SOIL PHYSICAL PROPERTIES AT SITE 54
 REMEDIAL INVESTIGATION CTO - 0303
 MCAS, NEW RIVER, NORTH CAROLINA

Soil Name	Soil Symbol	USCS Classification	Depth (inches)	Moist Bulk Density (g/cc)	Permeability (cm/s)	Soil Reaction (pH)	Shrink-Swell Potential	Organic Matter (percent)
Baymeade-Urban	BaB	SM, SP-SM	0 - 30	1.60 - 1.75	4.2×10^{-3} - 1.37×10^{-2}	4.5 - 6.5	Low	0.5 - 1.0

Source: Soil Survey: Camp Lejeune, North Carolina, U. S. Department of Agriculture - Soil Conservation Service, 1984.

- Notes:
- ML - Loam
 - SM - Loamy Fine Sand
 - SP - Fine Sand
 - - Not Estimated
 - SC - Fine Sandy Loam

TABLE 2-2

SUMMARY OF GROUNDWATER ELEVATIONS
 SITE 54
 REMEDIAL INVESTIGATION CTO-0303
 MCAS NEW RIVER, NORTH CAROLINA

Well No.	Casing Elevation	Static Water Levels (TOC)				Groundwater Elevations			
		3/28/95	4/10/95	5/10/95	8/18/95	3/28/95	4/10/95	5/10/95	8/18/95
54-GW01	20.39	9.22	9.22	10.13	10.30	11.17	11.17	10.26	10.09
54-GW02	23.83	11.50	11.78	12.24	12.46	12.33	12.05	11.59	11.37
54-GW03	13.38	3.70	4.04	4.86	4.60	9.68	9.34	8.52	8.78
54-GW04	15.12	3.83	4.08	4.54	5.42	11.29	11.04	10.58	9.70
54-GW05	19.37	7.82	8.08	8.52	8.72	11.55	11.29	10.85	10.65
54-GW06	20.77	9.22	9.45	9.86	10.14	11.55	11.32	10.91	10.63
54-GW07	21.47	9.32	9.62	10.12	10.28	12.15	11.85	11.35	11.19
54-GW08	20.99	NA	11.61	12.2	12.11	NA	9.38	8.79	8.88
54-GW09	18.77	NA	8.28	8.71	8.99	NA	10.49	10.06	9.78
54-GW10	19.43	NA	8.92	9.43	9.6	NA	10.51	10.00	9.83
54-SG01	8.97	0.92	NA	0.32	NA	6.55	NA	5.95	NA

Notes:

TOC = Top of Casing

TABLE 2-3

HYDRAULIC PROPERTIES SUMMARY
 SITE 54
 REMEDIAL INVESTIGATION CTO - 0303
 MCAS NEW RIVER, NORTH CAROLINA

Well ID	Conductivity		Transmissivity		Conductivity		Transmissivity		General Soil Description
	Rising Head (ft/day)	Falling Head (ft/day)	Rising Head (ft ² /day)	Falling Head (ft ² /day)	Rising Head (cm/day)	Falling Head (cm/day)	Rising Head (cm ² /day)	Falling Head (cm ² /day)	
54-GW03	8.2	5.6	82.0	56.0	2.89e-03	1.98e-03	0.9	0.6	Silty, sandy clay
54-GW04	8.8	8.9	88.0	89.0	3.11e-03	3.14e-03	0.9	1.0	F/M sand, trace silt & gravel w/ silty clay layers
54-GW06	50.5	35.6	353.5	249.2	1.78e-02	1.26e-02	3.8	2.7	F/C sand, trace silt & gravel
MAXIMUM	50.5	35.6	353.5	249.2	1.78e-02	1.26e-02	3.8	2.7	
MINIMUM	8.2	5.6	82	56	2.89e-03	1.98e-03	0.9	0.6	
AVERAGE	22.5	16.7	174.5	131.4	7.94e-03	5.90e-03	1.9	1.4	
54-GW07	17.2	12.0	3,440.0	2,400.0	6.07e-03	4.24e-03	37.0	25.8	Fossil. limestone, trace shells & silt w/silty sand
54-GW08	46.7	42.2	9,340.0	8,440.0	1.65e-02	1.49e-02	100.5	90.8	F/M sand, trace coarse sand & silt
AVERAGE	32.0	27.1	6,390.0	5,420.0	1.13e-02	9.57e-03	68.8	58.3	

Notes:

"--" Falling head slug test not performed as well level was within screened interval.
 Transmissivity calculation assumed 7 ft (54-GW06) and 10 ft thickness for surficial aquifer
 Transmissivity calculation assumed 200 ft thickness for the Castle Hayne aquifer.

TABLE 2-4

SUMMARY OF POTABLE WATER SUPPLY WELLS
 WITHIN A ONE-MILE RADIUS OF SITE 54
 REMEDIAL INVESTIGATION CTO-0303
 MCAS NEW RIVER, NORTH CAROLINA

Supply Well Number	Well Depth (ft)	Screened Interval (ft)	Well Dia. (in)	Approx. Dist. and Dir.	Status of Well	Al (µg/L)	Cu (µg/L)	Fe (µg/L)	Pb (µg/L)	Mn (µg/L)	Zn (µg/L)	Chloride (µg/L)	Fluoride (µg/L)	Nitrate/Nitrite (µg/L)	Sulfate (µg/L)	TDS (µg/L)
MCAS-131	200	NA (1)	NA	5,000ft/SSW	On	ND (2)	60	540 (3)	7	50	20	110,000	400	50	28,000	550,000 (3)
MCAS-4140	NA	NA	NA	3,700ft/NNW	On	300 (4)	180	180	ND	ND	ND	140,000	300	ND	10,000	620,000 (3)
MCAS-4150	NA	NA	NA	2,600ft/NW	Off	NA	NA	NA	NA	NA	NA	NA	NA	NA	NA	NA
MCAS-5001	193	NA	NA	2,500ft/W	On	250 (4)	ND	40	ND	ND	80	19,000	200	ND	ND	480,000
MCAS-5009	196	NA	NA	1,600ft/W	On	300 (4)	ND	320 (3)	ND	ND	ND	16,000	200	20	ND	310,000

Notes:

The analytical data presented in this table represent detected analytes.

(1) Status not available

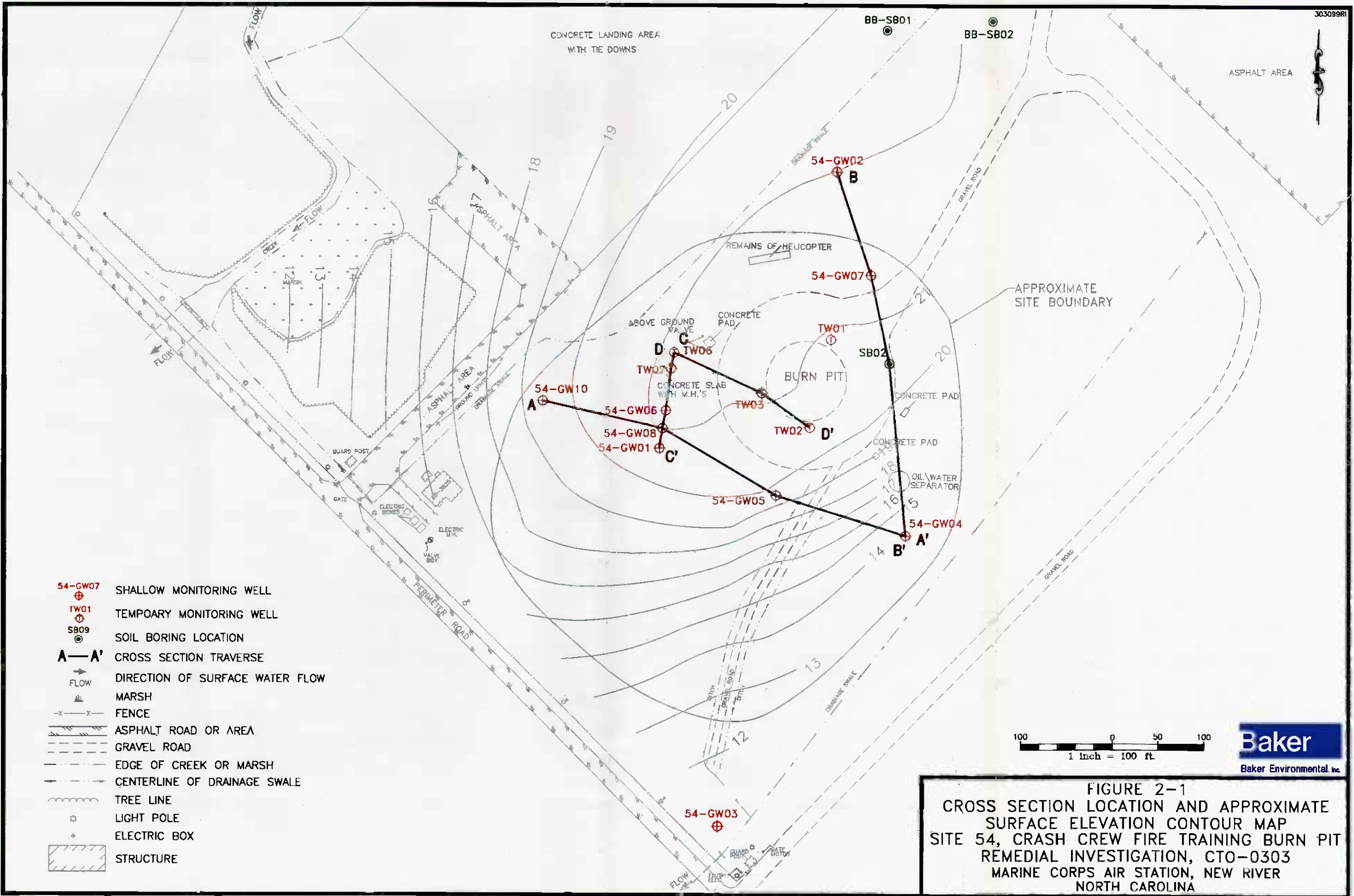
(2) Not detected

(3) Above USEPA & NC SMCL/Standard (Fe=300 µg/L, Mn=50 µg/L, TDS=500,000 µg/L)

(4) Above USEPA SMCL (Al=200 µg/L)

See Figure 2-6 for well locations.

SECTION 2.0 FIGURES



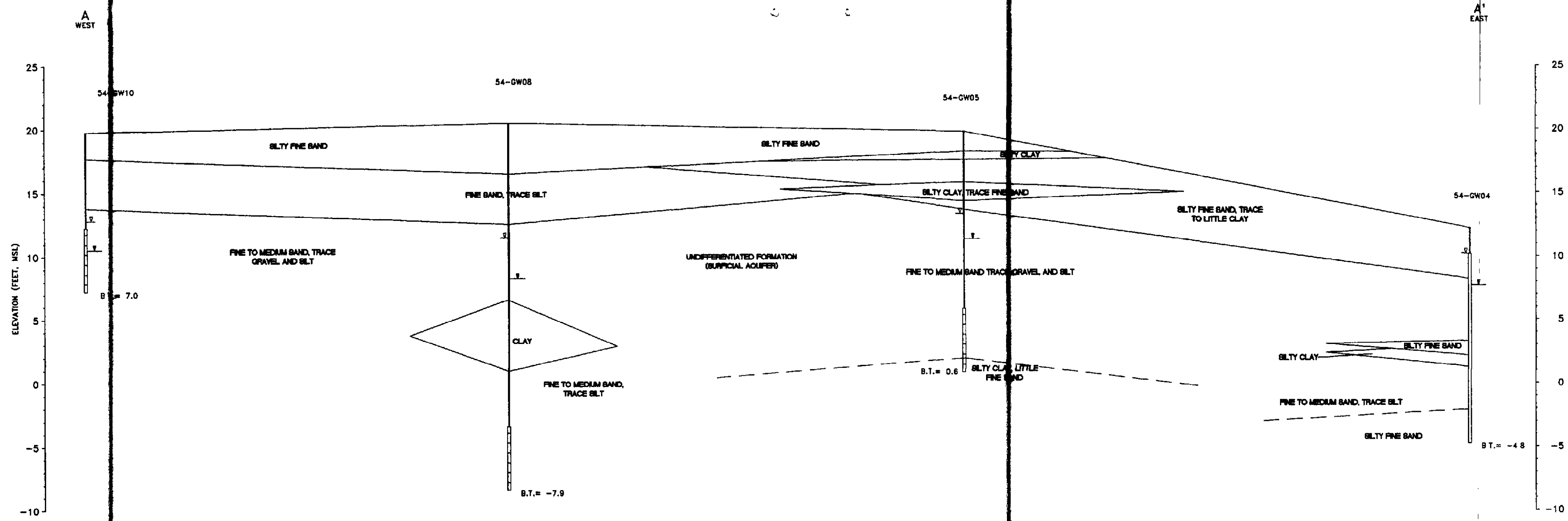
- 54-GW07 SHALLOW MONITORING WELL
- TW01 TEMPOARY MONITORING WELL
- SB09 SOIL BORING LOCATION
- A—A' CROSS SECTION TRAVERSE
- FLOW DIRECTION OF SURFACE WATER FLOW
- MARSH
- FENCE
- ASPHALT ROAD OR AREA
- GRAVEL ROAD
- EDGE OF CREEK OR MARSH
- CENTERLINE OF DRAINAGE SWALE
- TREE LINE
- LIGHT POLE
- ELECTRIC BOX
- STRUCTURE

100 0 50 100
1 inch = 100 ft.

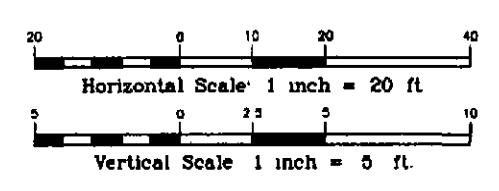


FIGURE 2-1
CROSS SECTION LOCATION AND APPROXIMATE
SURFACE ELEVATION CONTOUR MAP
SITE 54, CRASH CREW FIRE TRAINING BURN PIT
REMEDIAL INVESTIGATION, CTO-0303
MARINE CORPS AIR STATION, NEW RIVER
NORTH CAROLINA

01717AA02Y



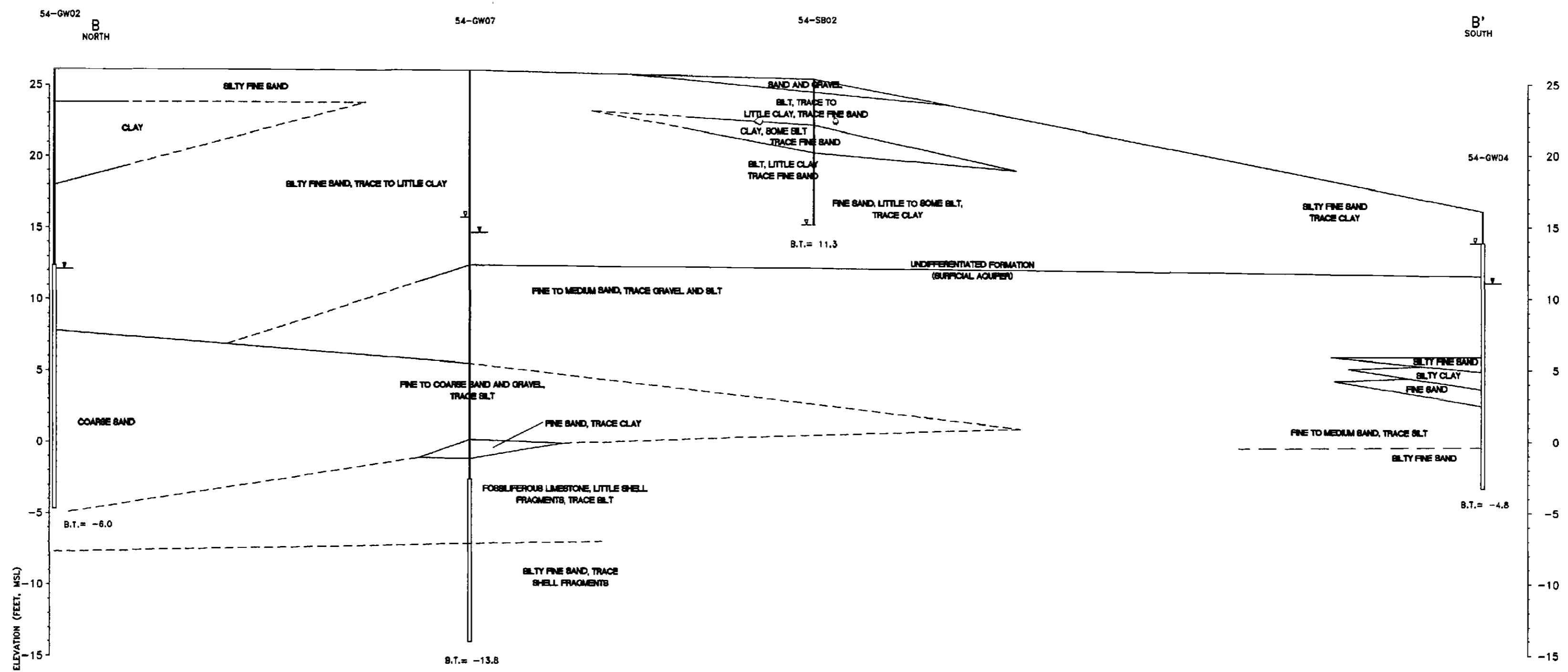
LEGEND
 ▽ STATIC WATER LEVEL (MAY 10, 1995)
 ▭ GROUNDWATER ENCOUNTERED IN SOIL BORING TERMINATED, ELEVATION MSL
 ▭ WELL SCREEN INTERVAL
 — ESTIMATED
 - - - PROJECTED



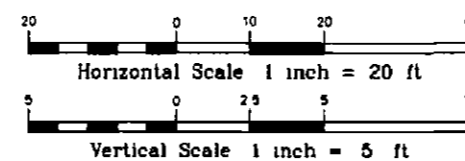
NOTE
 -THE SOIL BORING INFORMATION IS CONSIDERED TO BE REPRESENTATIVE OF SUBSURFACE CONDITIONS AT THE RESPECTIVE BORING LOCATIONS. SUBSURFACE CONDITIONS INTERPOLATED BETWEEN BORINGS ARE ESTIMATED BASED ON ACCEPTED SOIL ENGINEERING PRINCIPLES AND GEOLOGIC JUDGEMENT.

<p>REVISIONS</p>	<p>DRAWN WAC REVIEWED MKD S.O.# 62470-303-0000-05200 CADD# 303061RI</p>	<p>NORTH</p>	<p>REMEDIAL INVESTIGATION, CTO-0303 MARINE CORPS AIR STATION, NEW RIVER NORTH CAROLINA</p> <p>BAKER ENVIRONMENTAL, Inc. Coraopolis, Pennsylvania</p>		<p>GEOLOGIC CROSS SECTION A-A' SITE 54, CRASH CREW FIRE TRAINING BURN PIT</p> <p>SCALE AS SHOWN DATE JANUARY 1996</p>	<p>FIGURE No. 2-2</p>
-------------------------	--	---------------------	--	--	---	---

01717AAB3X



- LEGEND**
- y — STATIC WATER LEVEL (MAY 10, 1995)
 - 0 — GROUNDWATER ENCOUNTERED IN SOIL BORING TERMINATED, ELEVATION MSL
 - B.T. — BORING TERMINATED, ELEVATION MSL
 - B — WELL SCREEN INTERVAL
 - — ESTIMATED
 - - - - PROJECTED
 - — — FORMATION CONTACT



NOTE:
 — THE SOIL BORING INFORMATION IS CONSIDERED TO BE REPRESENTATIVE OF SUBSURFACE CONDITIONS AT THE RESPECTIVE BORING LOCATIONS. SUBSURFACE CONDITIONS INTERPOLATED BETWEEN BORINGS ARE ESTIMATED BASED ON ACCEPTED SOIL ENGINEERING PRINCIPLES AND GEOLOGIC JUDGEMENT.

REVISIONS

DRAWN WAC
REVIEWED MKD
S.O.# 62470-303-0000-05200
CADD# 303062RI

NORTH



REMEDIAL INVESTIGATION, CTO-0303
 MARINE CORPS AIR STATION, NEW RIVER
 NORTH CAROLINA

BAKER ENVIRONMENTAL, Inc.
 Coraopolis, Pennsylvania



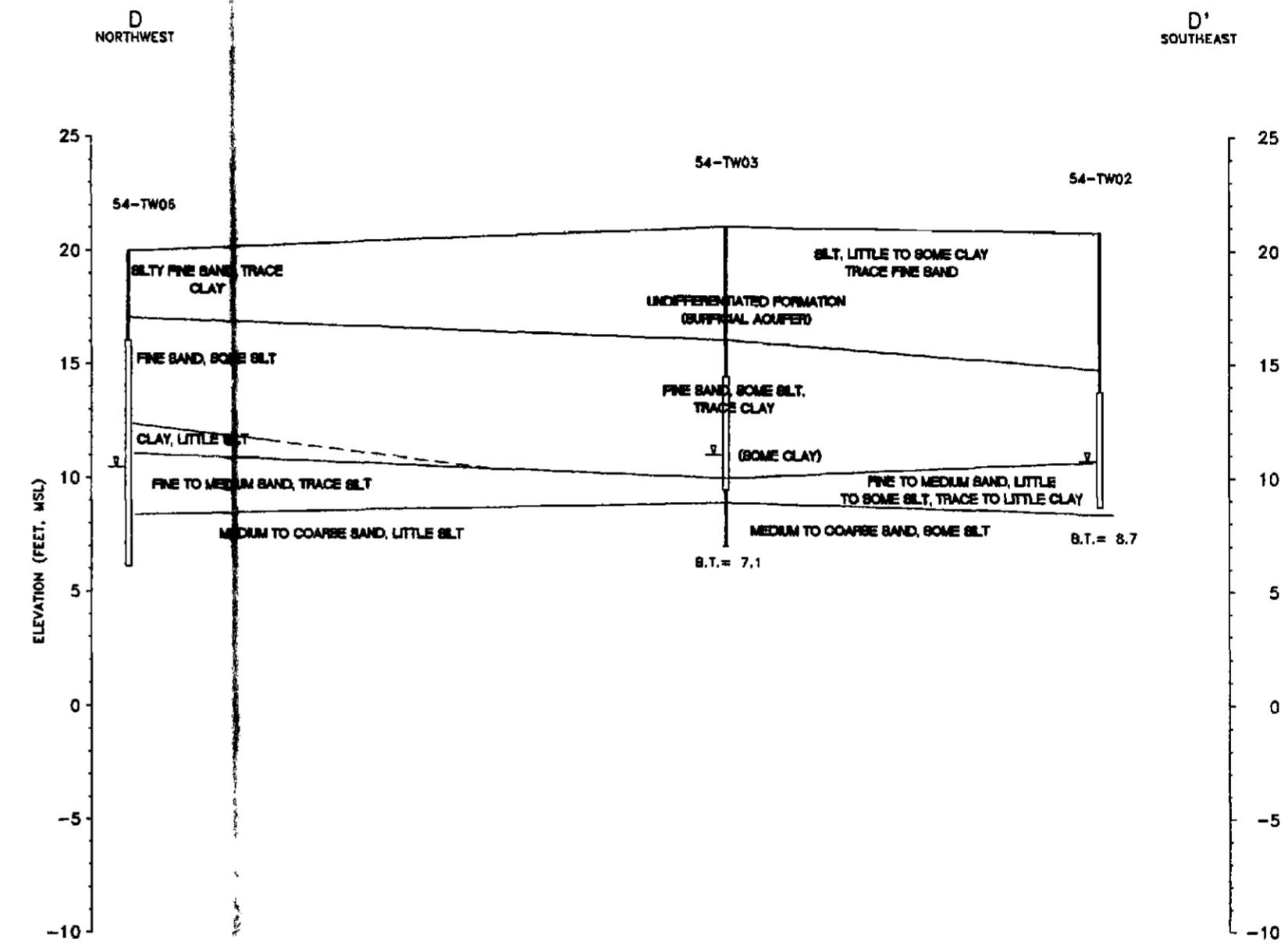
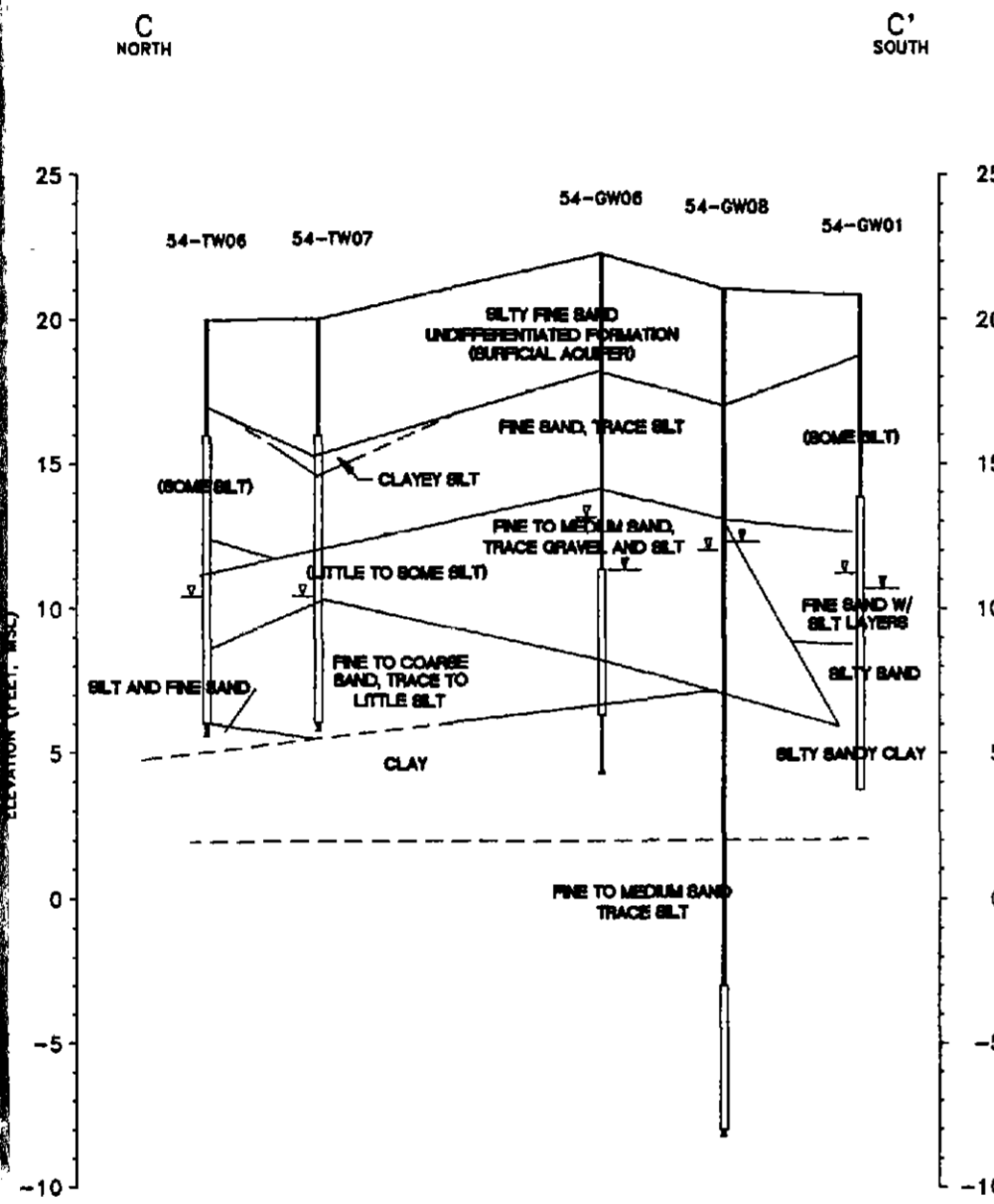
GEOLOGIC CROSS SECTION B-B'
SITE 54, CRASH CREW FIRE TRAINING BURN PIT

SCALE AS SHOWN

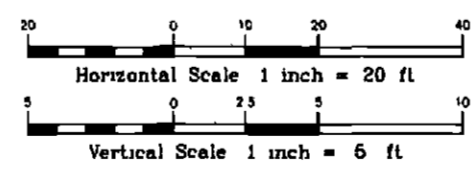
DATE JANUARY 1996

FIGURE No.

2-2
 cont'd.



LEGEND
 - - - - - STATIC WATER LEVEL (MAY 10, 1995)
 - - - - - GROUNDWATER ENCOUNTERED IN SOIL BORING TERMINATED, ELEVATION MSL
 - - - - - WELL SCREEN INTERVAL
 - - - - - ESTIMATED
 - - - - - PROJECTED



NOTE:
 -THE SOIL BORING INFORMATION IS CONSIDERED TO BE REPRESENTATIVE OF SUBSURFACE CONDITIONS AT THE RESPECTIVE BORING LOCATIONS. SUBSURFACE CONDITIONS INTERPOLATED BETWEEN BORINGS ARE ESTIMATED ON ACCEPTED SOIL ENGINEERING PRINCIPLES AND GEOLOGIC JUDGMENT.

REVISIONS DRAWN WAC REVIEWED MKD S.O.# 62470-303-0000-05200 CADD# 303063RI	NORTH 	REMEDIAL INVESTIGATION, CTO-0303 MARINE CORPS AIR STATION, NEW RIVER NORTH CAROLINA	 Baker Environmental, Inc. Coraopolis, Pennsylvania	GEOLGIC CROSS SECTIONS C-C' & D-D' SITE 54, CRASH CREW FIRE TRAINING BURN PIT	FIGURE No. 2-2 (cont'd.)
		SCALE AS SHOWN		DATE JANUARY 1996	

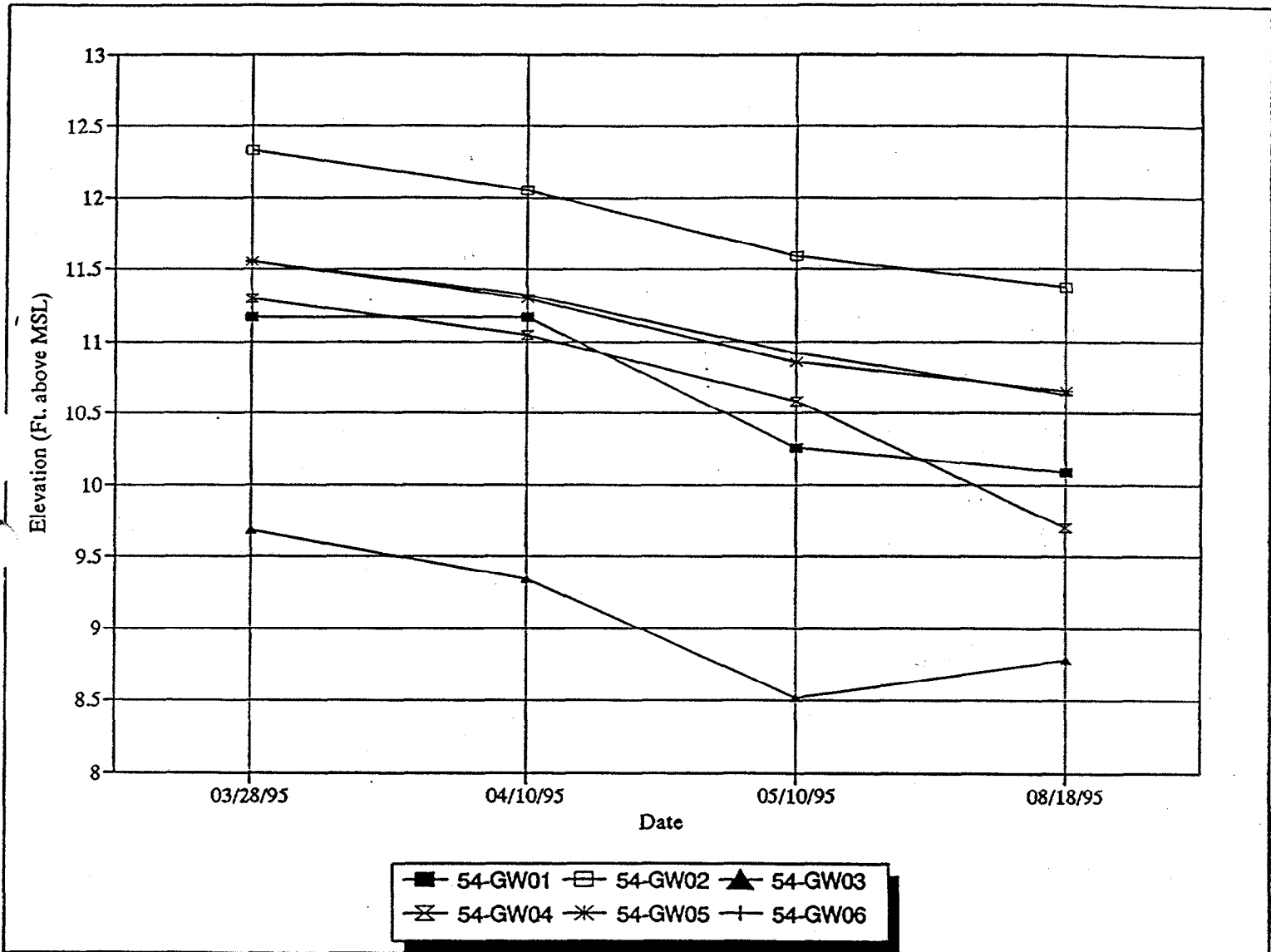


FIGURE 2-3A
GROUNDWATER ELEVATION TRENDS
AT SITE 54
REMEDIAL INVESTIGATION CTO-0303
MCAS NEW RIVER, NORTH CAROLINA

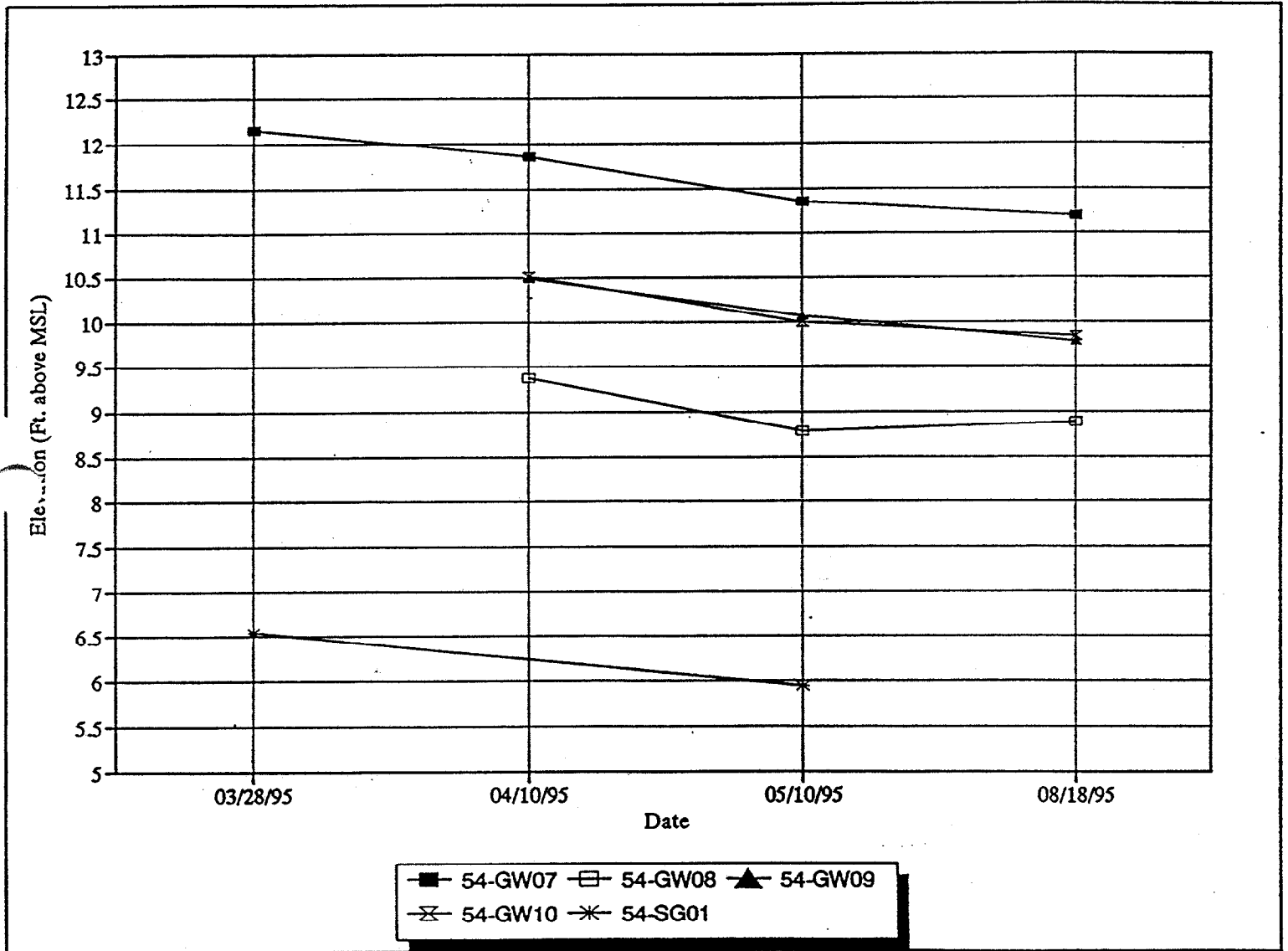
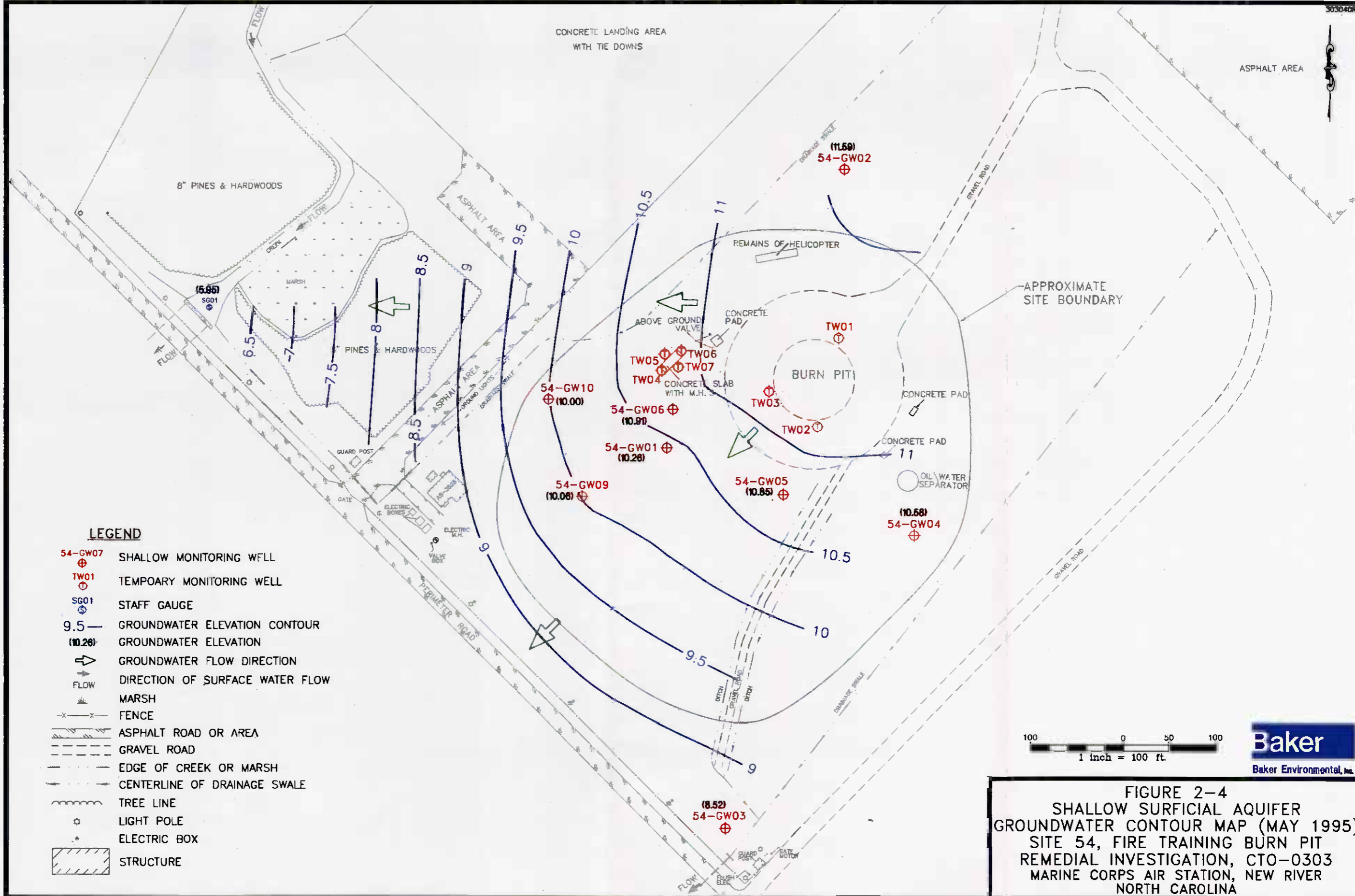


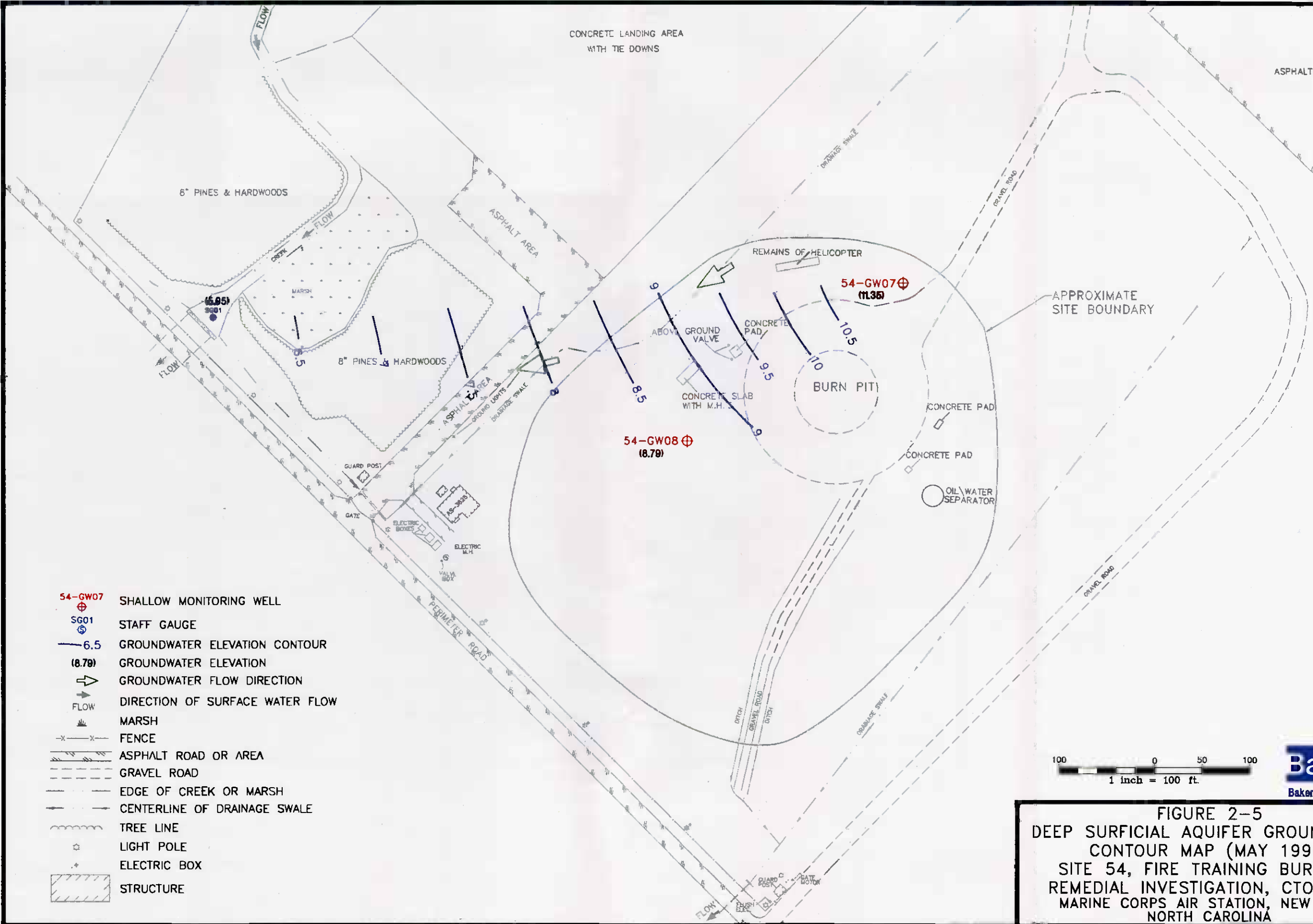
FIGURE 2-3B
 GROUNDWATER ELEVATION TRENDS
 AT SITE 54
 REMEDIAL INVESTIGATION CTO-0303
 MCAS NEW RIVER, NORTH CAROLINA



01717AAB4Y

ASPHALT AREA

CONCRETE LANDING AREA WITH TIE DOWNS

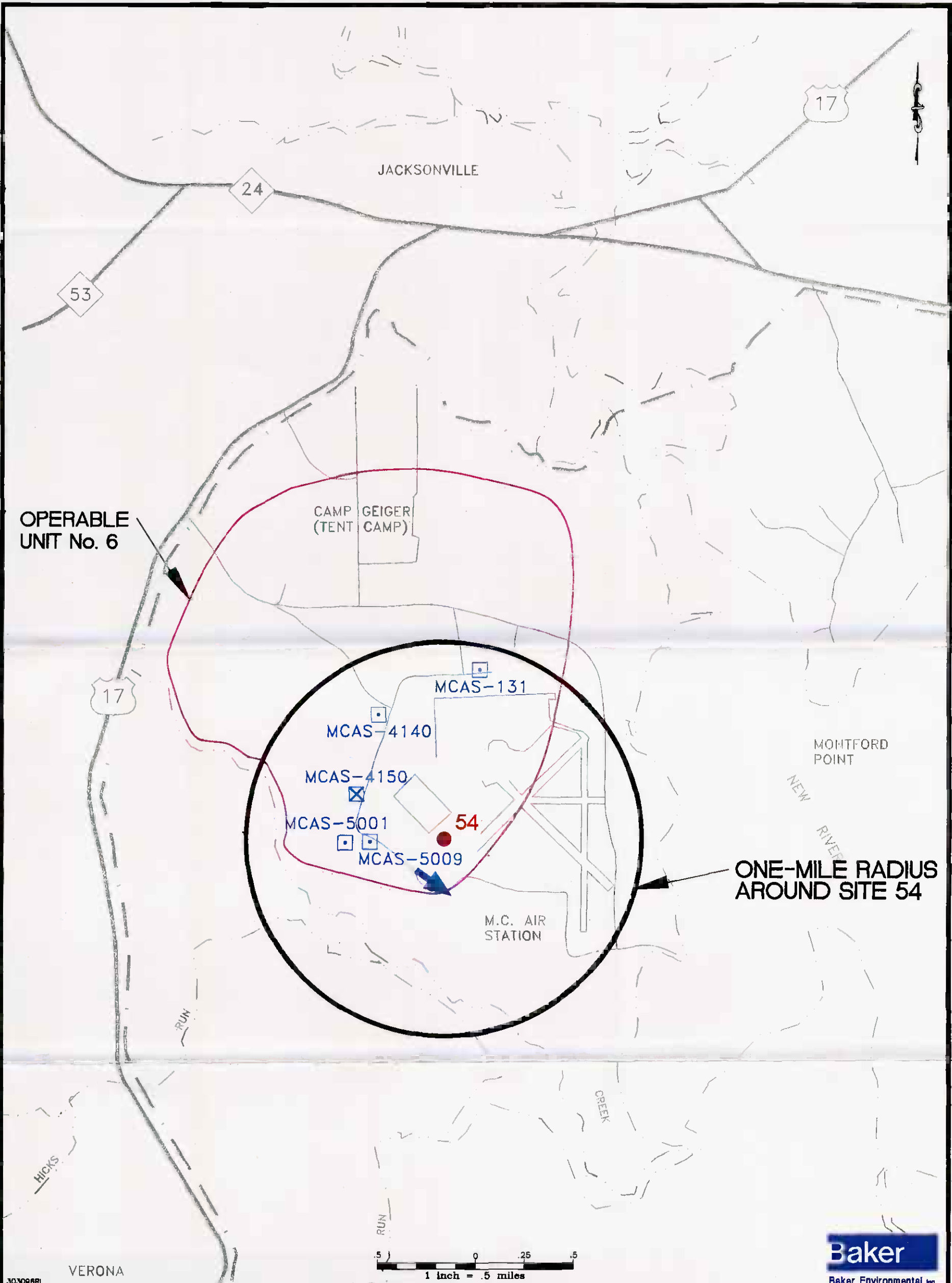


- ⊕ 54-GW07 SHALLOW MONITORING WELL
- ⊕ SG01 STAFF GAUGE
- 6.5 GROUNDWATER ELEVATION CONTOUR
- (8.79) GROUNDWATER ELEVATION
- ➔ GROUNDWATER FLOW DIRECTION
- ➔ FLOW DIRECTION OF SURFACE WATER FLOW
- 🌿 MARSH
- x-x- FENCE
- ▬ ASPHALT ROAD OR AREA
- - - - - GRAVEL ROAD
- - - - - EDGE OF CREEK OR MARSH
- - - - - CENTERLINE OF DRAINAGE SWALE
- 🌳 TREE LINE
- ☆ LIGHT POLE
- ⊕ ELECTRIC BOX
- ▭ STRUCTURE

100 0 50 100
 1 inch = 100 ft.

Baker
 Baker Environmental, Inc.

FIGURE 2-5
 DEEP SURFICIAL AQUIFER GROUNDWATER
 CONTOUR MAP (MAY 1995)
 SITE 54, FIRE TRAINING BURN PIT
 REMEDIAL INVESTIGATION, CTO-0303
 MARINE CORPS AIR STATION, NEW RIVER
 NORTH CAROLINA



OPERABLE
UNIT No. 6

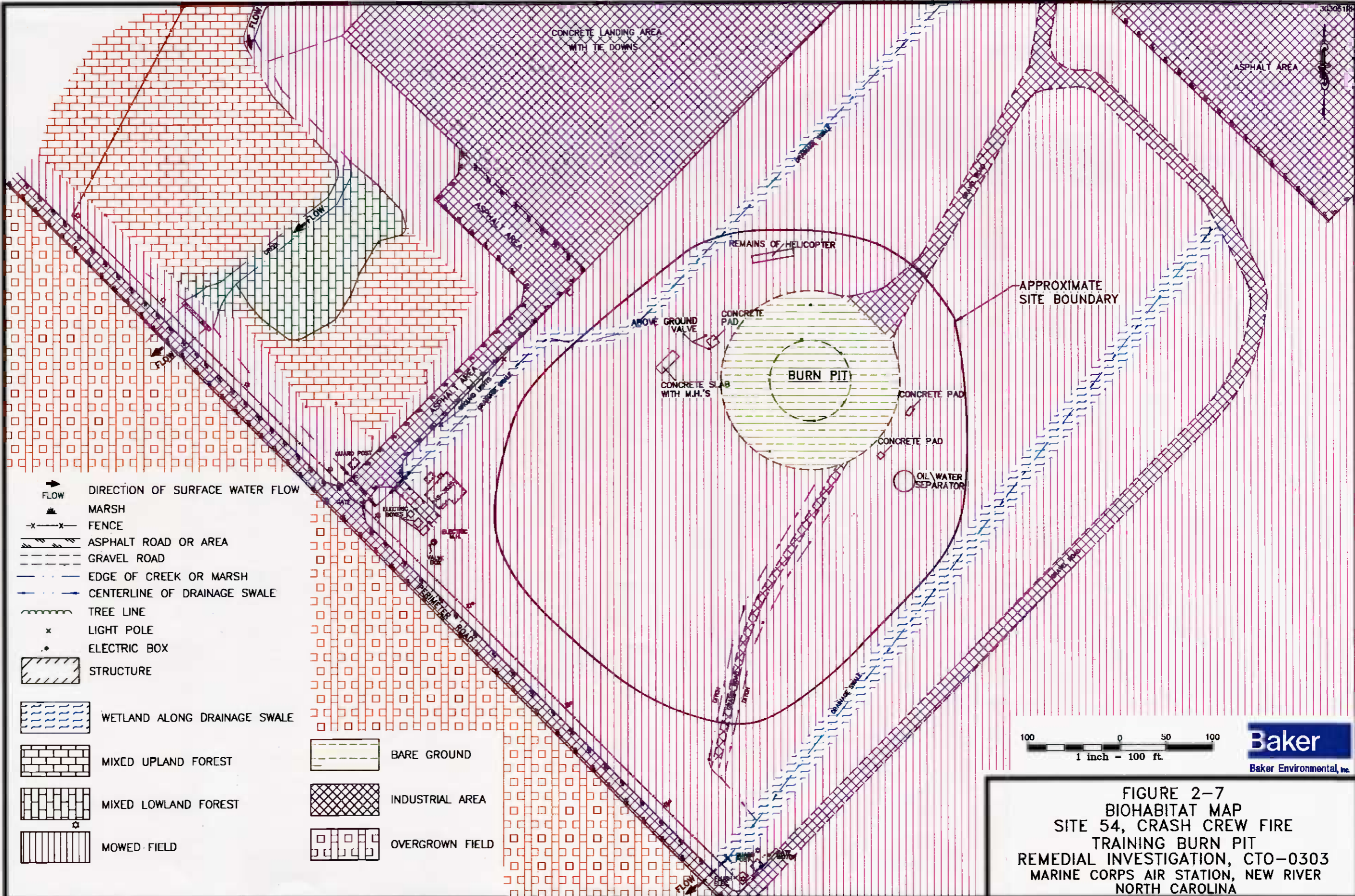
ONE-MILE RADIUS
AROUND SITE 54

LEGEND	
MCAS-131	- WATER SUPPLY WELL IN SERVICE
MCAS-4150	- WATER SUPPLY WELL OUT OF SERVICE
	- APPROXIMATE DIRECTION OF GROUNDWATER FLOW IN THE CASTLE HAYNE AQUIFER.

SOURCE: LANTDIV, OCT. 1991

FIGURE 2-6
POTABLE WATER SUPPLY WELLS
WITHIN A ONE-MILE RADIUS
SITE 54, CRASH CREW FIRE
TRAINING BURN PIT
REMEDIAL INVESTIGATION, CTO-0303
MARINE CORPS BASE, CAMP LEJEUNE
NORTH CAROLINA





- FLOW DIRECTION OF SURFACE WATER FLOW
- Marsh symbol MARSH
- x-x- FENCE
- Asphalt road symbol ASPHALT ROAD OR AREA
- Gravel road symbol GRAVEL ROAD
- Edge of creek or marsh symbol EDGE OF CREEK OR MARSH
- Centerline of drainage swale symbol CENTERLINE OF DRAINAGE SWALE
- Tree line symbol TREE LINE
- x LIGHT POLE
- ELECTRIC BOX
- Structure symbol STRUCTURE

- Wetland along drainage swale symbol WETLAND ALONG DRAINAGE SWALE
- Mixed upland forest symbol MIXED UPLAND FOREST
- Mixed lowland forest symbol MIXED LOWLAND FOREST
- Mowed field symbol MOWED FIELD
- Bare ground symbol BARE GROUND
- Industrial area symbol INDUSTRIAL AREA
- Overgrown field symbol OVERGROWN FIELD

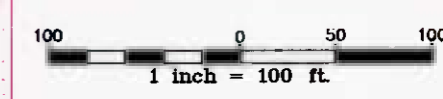


FIGURE 2-7
BIOHABITAT MAP
SITE 54, CRASH CREW FIRE
TRAINING BURN PIT
REMEDIAL INVESTIGATION, CTO-0303
MARINE CORPS AIR STATION, NEW RIVER
NORTH CAROLINA

3.0 STUDY AREA INVESTIGATIONS

The field investigation program at OU No. 6, Site 54, was initiated to detect and characterize potential impacts to human health and the environment resulting from past waste management activities. This section discusses the site-specific RI field investigation activities that were conducted to fulfill the objective. The RI field investigation of OU No. 6 commenced on February 20, 1995 and continued through May 10, 1995. The RI field program at Site 54 consisted of a site survey; a soil investigation, which included drilling and sampling; a groundwater investigation, which included monitoring well installation, sampling, and aquifer testing; and a habitat evaluation. The following sections detail the various investigation activities carried out during the RI.

3.1 Site Survey

The site survey task was performed in two phases: Phase I - Initial Survey of Site Features; and Phase II - Post Investigation Survey of Monitoring Wells and Sampling Locations. Phase I of the survey task was conducted at Site 54 during March of 1994. Based upon the Final Site Summary Report (ESE, 1990), surface features within and surrounding the burn pit were surveyed. The proposed soil boring and monitoring well locations identified in the Final RI/FS Work Plan for OU No. 6 (Baker, 1994), were subsequently located as part of the Phase I survey and marked with wooden stakes. Each sample location was assigned a unique identification number that corresponded to the site and media to be sampled.

Phase II of the site survey task was completed at Site 54 during the week of May 10, 1995. During Phase II, all existing and newly installed monitoring wells were surveyed. Supplemental or relocated soil borings completed during the investigation were also surveyed. A number of soil borings were relocated from the locations proposed in the project plans (i.e., moved more than ten feet from their proposed locations) due to the presence of either underground or overhead utilities. Soil test borings were also moved from their proposed locations based upon observed site conditions. Additionally, a staff gauge installed in an adjacent creek was also surveyed during Phase II. Latitude, longitude, and elevation in feet above msl were recorded for each surveyed point.

3.2 Soil Investigation

The soil investigation performed at Site 54 was intended to:

- Assess the nature and extent of contamination that may have resulted from previous disposal practices or site activities.
- Assess the human health, ecological, and environmental risks associated with exposure to surface and subsurface soils.
- Characterize the geologic setting of the study area.

The subsections which follow describe soil sample collection procedures, sampling locations, and the analytical program initiated during the soil investigation at Site 54.

3.2.1 Soil Sampling Procedures

Sampling activities at Site 54 commenced on March 7, 1995. Soil collection was performed using a truck-mounted direct-push (GeoProbe™) sampling system. The direct-push sampling system employed a stainless steel cutting shoe and collection tube. A dedicated acetate liner, inserted into the stainless steel collection tube, was used to collect and then extrude soil samples for field and laboratory analyses. All soil sampling activities conducted at Site 54 were performed in Level D personnel protection. Soil cuttings obtained during the soil investigation were collected, handled, and stored according to the procedures outlined in Section 3.6.

Two types of borings were installed during the soil investigation: exploratory test borings (i.e., borings installed for sample collection and description of subsurface units) and borings advanced for the purpose of monitoring well installation. An initial series of exploratory test borings were collected at several locations throughout Site 54 to preliminarily identify areas of total petroleum hydrocarbon (TPH) contamination. These initial field screening samples were obtained from the first four feet below ground surface. At locations where improved road surface material (i.e., coarse gravel) was present, composite screening samples were obtained from one to four feet below ground surface (i.e., below the overburden material). Based upon immunoassay field testing results, portions of the study area were identified for further, confirmatory, investigation. Figure 3-1 depicts both screening sample locations, denoted as 54-ES01 through 54-ES18, and confirmation sample locations.

Confirmation soil samples from exploratory test borings, located within areas identified by the initial series of field screening samples, were submitted for laboratory analysis (see Section 3.2.3). Soils obtained from the subsequent exploratory borings were collected from the surface (i.e., ground surface to a depth of twelve inches) and at continuous two-foot intervals starting at one foot below ground surface. Due to the presence of gravel overburden material within the central portion of the study area, certain site-specific drilling practices were implemented. A decontaminated three-inch outside diameter (OD) stainless steel auger was employed to remove the overburden material. Continuous sample collection proceeded from approximately one-foot below ground surface until the boring was terminated at the depth of the water table, which varied at Site 54 from 4 to 12 feet below ground surface. An additional soil sample was collected from below the water table to confirm groundwater depth and ensure that the true water table (i.e., not a perched zone) had been encountered.

Samples were collected for soil description from the ground surface, where conditions warranted, and at continuous two-foot intervals to the water table. Each soil was classified in the field by a geologist using the Unified Soil Classification System (USCS) in accordance with the visual-manual methods described by the American Society for Testing and Materials (ASTM, 1993). Descriptions were recorded in a field logbook and later transposed onto boring log records. Soil classification included characterization of soil type, grain size, color, moisture content, relative density, plasticity, and other pertinent information such as indications of contamination. Descriptions of site soils are provided on Test Boring Records in Appendix A and on Test Boring and Well Construction Records in Appendix B.

Surface and selected subsurface (i.e., greater than one foot below ground surface) soil samples were retained for laboratory analysis from the confirmatory soil borings. Both surface and subsurface samples were collected to evaluate the nature and extent of potentially impacted soils and to perform for human health risk assessment; however, only the surface soils were employed for the ecological

risk assessment. A summary of test boring identification numbers, boring depths, sampling intervals, and laboratory analyses for Site 54 soil samples is provided in Tables 3-1 and 3-2.

A minimum of two samples were retained for laboratory analysis from each of the soil boring locations. Each soil sample was prepared and handled according to USEPA Region IV Standard Operating Procedures (SOPs). Samples collected for volatile organic analysis were extracted with a stainless-steel spoon from different sections of the extruded soil core so that the resulting composite was representative of the entire sampling interval. Precautions were taken not to aerate the sample, thus minimizing volatilization. Samples retained for other analytical parameters (e.g., semivolatiles, pesticides, PCBs, TPH and metals) were thoroughly homogenized prior to being placed in the appropriate laboratory containers.

Following sample collection, each sample retained for laboratory analysis was stored on ice in a cooler. Sample preparation also included documentation of sample number, depth, location, date, time, and analytical parameters in a field logbook. Chain-of-Custody documentation, copies of which are provided in Appendix D, included information such as sample number, date, time of sampling, and sampling personnel, accompanied the samples to the laboratory. Samples were shipped by overnight courier to the laboratory.

3.2.2 Sampling Locations

The sampling distribution employed at Site 54 was intended to identify if contamination was present and, if so, to evaluate the vertical and horizontal extent within the study area. The soil sampling program focused on known or suspected areas impacted by burn pit operations. Previous investigatory data and background reports were used to locate potential sampling locations. Figure 3-1 depicts soil sampling locations at Site 54.

A total of 34 borings were completed at Site 54 to assess the suspected impact of burn pit operations; two of those borings were utilized for the installation of monitoring wells. Eighteen of the 34 borings were collected during the initial screening investigation. Based upon the initial screening results, nine borings were completed at locations identified for further confirmation sampling. As stipulated in the Final RI/FS Work Plan for OU No. 6 (Baker, 1994), the remaining five soil borings were collected from a dry ditch which provides surface water drainage for the burn pit area. Two additional borings, to the north of the study area, were advanced to assess background contaminant concentrations (54-BB-SB01 and 54-BB-SB02).

Fourteen of the 18 field screening samples were collected from immediately surrounding the burn pit. The remaining four field screening samples were collected from a smaller area to the southwest of the burn pit, identified during a project scoping site visit. This smaller outlying area was characterized by a lack of vegetative cover, possibly resulting from site operations. Results of the field test screening process were used to position the subsequent confirmation test borings, temporary wells, and permanent wells as provided in Figure 3-1.

3.2.3 Analytical Program

The analytical program employed during the soil investigation at Site 54 focused on suspected contaminants of concern, as indicated by information regarding previous burn pit operations and investigation results. The 18 samples generated during the initial soil screening event were analyzed for petroleum hydrocarbons using an immunoassay field test. The field testing was performed with

an EnSys PETRO RIS[®] Soil Test System in accordance with proposed EPA Method 4030 for immunoassay-based field screening of petroleum compounds in soil. Immunoassay results were recorded in units relative to 15 and 60 parts per million (ppm), as provided in Appendix C. Four of the 18 screening samples were submitted to the laboratory for confirmation analyses.

Based upon results from the initial screening investigation, portions of the study area were identified for confirmatory investigation. Samples from each of the subsequent nine test borings were analyzed for TPH, TCL volatiles, and TCL semivolatiles. Samples from two of the nine test borings and each of the five ditch samples were analyzed for both TAL inorganics and full TCL organics (i.e., volatiles, semivolatiles, pesticides, and PCBs). Samples were prepared and handled as described in the previous section.

In addition to analyzing for the contaminants of concern, three composite soil samples were collected for analysis of engineering parameters (i.e., particle size, and Atterberg limits). Engineering samples were comprised of individual grab samples collected from the ground surface to the water table. Tables 3-1 and 3-2 present a summary of requested soil analyses.

3.2.4 Quality Assurance and Quality Control

Field quality assurance and quality control (QA/QC) samples were collected during the soil investigation. These samples were obtained to: (1) monitor that decontamination procedures were properly implemented (equipment rinsate samples); (2) evaluate field methodologies (duplicate samples); (3) establish field background conditions (field blanks); and (4) evaluate whether cross-contamination occurred during sampling and shipping (trip blanks). Data Quality Objectives (DQOs) for the QA/QC samples were implemented in accordance with DQO Level IV as defined in the Environmental Compliance Branch SOPs and Quality Assurance Manual, USEPA Region IV (USEPA, 1991). This DQO level is equivalent to the Naval Facilities Engineering Service Center (NFESC) DQO Level D, as specified in the "Sampling and Chemical Analysis Quality Assurance Requirements for the Navy Installation Restoration Programs" document (NEESA, 1988).

Four types of field QA/QC samples were collected and analyzed including: duplicate samples; equipment rinsate samples; field blanks; and trip blanks. The definition of each is listed below (USEPA, 1991):

- Duplicate Sample: Two or more samples collected simultaneously into separate containers from the same source under identical conditions.
- Equipment Blanks: Equipment field blanks (or rinsate blanks) are defined as samples which are obtained by running organic free water over/through sample collection equipment after it has been cleaned. These samples are used to determine if decontamination procedures were adequate. A minimum of one equipment blank per sample media was collected daily, however, only every other blank was analyzed.
- Field Blanks: Organic-free water is taken to the field in sealed containers and poured into the appropriate sample containers at designated locations. This is done to determine if contaminants present in the area may have an affect on the sample integrity.

- Trip Blanks: Trip blanks are prepared prior to the sampling event, placed in the actual sample container, and kept with the investigative samples throughout the sampling event. They are then packaged for shipment with the other samples and sent for analysis. At no time after their preparation are the sample containers to be opened before they return to the laboratory. Field sampling teams utilize volatile organic trip blanks to determine if samples were contaminated during storage and transportation back to the laboratory. If samples are to be shipped, trip blanks are to be provided for each shipment but not necessarily for each cooler (i.e., trip blanks in coolers with samples for VOC analyses only).

Table 3-3 summarizes field QA/QC sample types, sample frequencies, the number of QA/QC samples, and parameters analyzed. Field QA/QC samples were collected at Site 54 according to the procedures outlined in the USEPA Region IV SOPs.

3.2.5 Air Monitoring and Field Screening

Several air monitoring and field screening procedures were implemented during soil investigation activities at Site 54. Ambient air monitoring for volatile contaminants was performed at each open borehole using a photoionization detector (PID). Soil samples were also field screened for volatile organic contaminants with a PID. Measurements obtained in the field were recorded in a logbook and later transposed onto the Test Boring Records and the Well Construction Records provided in Appendices A and B. Prior to daily monitoring, the field instruments were calibrated and documentation was recorded in a field logbook and on appropriate calibration forms.

3.3 Groundwater Investigation

The groundwater investigation performed at Site 54 was intended to:

- Assess the nature and extent of contamination that may have resulted from previous disposal practices or site activities.
- Assess human health and environmental risks associated with exposure to groundwater.
- Characterize the hydrogeologic setting of the study area.

The subsections which follow describe well installation procedures, well development procedures, sampling locations, sample collection procedures, the analytical program, and hydraulic conductivity test procedures employed during the groundwater investigation at Site 54.

3.3.1 Monitoring Well Installation

Six shallow Type II monitoring wells (i.e., wells installed without casing to seal off a semi-confining or confining layer) were installed at Site 54 during March and April of 1995. Locations of the newly installed monitoring wells are shown on Figure 3-2. The shallow monitoring wells were situated spatially to intercept potentially impacted groundwater from the suspected disposal areas, and to characterize the nature and horizontal extent of possible contamination. The existing and newly-installed monitoring wells were also used to evaluate groundwater flow patterns within the upper portion of the surficial aquifer. In addition to the Type II monitoring wells, one shallow

Type III monitoring well (i.e., a well installed with casing to seal off a confining or semi-confining layer) was also installed during April of 1995, at Site 54 (refer to Figure 3-2). The shallow Type III monitoring well was installed to assess the nature and vertical extent of contamination at Site 54. Placement of the newly installed monitoring wells was based on review of previous investigation results and analytical data gathered during the initial phase of the field investigation.

Shallow monitoring wells were installed after the pilot hole test boring was advanced to the desired depth. Each borehole was reamed with 6-1/4-inch internal diameter (ID) hollow stem augers prior to shallow Type II well installation. Shallow well depths ranged from 18 to 35 feet below ground surface. In general, the shallow wells were installed approximately 10 feet below the water table encountered during the pilot hole test boring. Shallow monitoring wells were installed with screened intervals bi-secting the water table sufficiently to compensate for seasonal variations in the water table which is known to fluctuate from two to four feet. The one Type III well was set at a depth of 30 feet below ground surface. Well construction details are summarized in Table 3-4, and well construction diagrams are shown on the Test Boring and Well Construction Records provided in Appendix B.

The one Type III monitoring well (54-GW08) was installed upon completion of the pilot hole test boring, which was advanced using the wash and mud rotary drilling methods. The borehole was drilled with a 6-inch wing bit prior to well installation. The Type III monitoring well was screened at an interval just below the semi-confining unit, approximately 25 to 30 feet below ground surface (refer to Table 3-4 and Appendix B for well construction details).

All of the permanent monitoring wells were constructed of two-inch nominal diameter, Schedule 40, flush-joint and threaded, polyvinyl chloride (PVC) casing. Justification for the use of PVC casing is provided in Appendix B of the Field Sampling and Analysis Plan for Operable Unit No. 6 (Baker, 1994). Each shallow Type II well utilized a 15-foot screened interval comprised of a 10- and 5-foot long No. 10 (i.e., 0.01 inch) slotted screen sections. The Type III shallow monitoring well was constructed with a five-foot No. 10 slotted screen section. A fine-grained sand pack (i.e., No. 1 silica sand), extending approximately 2 feet above the top of the screen, was placed in the annulus between the screen and the borehole wall from inside the augers during shallow Type II well installation. The sand pack was poured manually down the borehole during the Type III well installation and checked continuously with a weighted tape measure to determine sand pack depth. A two- to three-foot sodium bentonite pellet seal was placed above the sand pack by dropping pellets down the borehole. The bentonite pellets were hydrated with potable water after placement. A sodium bentonite slurry was used to backfill the annular space from above the bentonite pellet seal to the bottom of the steel casing (i.e., above the semi-confining unit). The remaining annular space was backfilled with a mixture of Portland cement and five percent powdered bentonite. During construction of the Type III wells, portland cement was used to secure six-inch steel casing to the uppermost portion of the semi-confining layer. A five-foot by five-foot concrete pad was placed around the protective well casing and four protective bollard posts were installed around the corners of the concrete pad. A four-inch protective well casing with locking cover was placed over the well and set into the cement pad. Well tags, which provide construction information, were installed at the top of each well. Typical shallow Type II and Type III well construction details are shown on Figures 3-3 and 3-4.

Seven temporary wells were employed to assess groundwater conditions at Site 54. The temporary wells were constructed of one-inch nominal diameter, Schedule 40, flush-joint and threaded PVC

casing placed in an open borehole. A filter sock was used to filter fine materials from the surrounding formation. Immediately following sample acquisition the temporary well was removed.

3.3.2 Monitoring Well Development

Following well construction and curing of the bentonite seal and cement grout, each newly installed monitoring well was developed to remove fine-grained sediment from the screen and sandpack and to establish interconnection between the well and the surrounding formation. The shallow Type II wells were developed by a combination of surging and pumping. The shallow Type III well was developed using a forced air system, equipped with a filter, and "lifting" the water out of the well. Typically, 20 to 40 gallons of water were evacuated from the shallow wells, followed by 10 minutes of surging, then continued pumping. Groundwater recovered during well development was temporarily stored in drums, then transferred into an on-site storage tank (refer to Section 3.6). Pumping hoses, constructed of flexible PVC, were used once and discarded to minimize the potential for cross contamination. Well development for the seven temporary wells was accomplished by purging prior to sampling.

Three to five borehole volumes were removed from each well, where conditions permitted, until the groundwater was essentially sediment-free. Measurements of pH, specific conductance, and temperature were recorded after each volume was removed to assist in assessing well stabilization. Additionally, periodic flow and volume measurements were also recorded during development to evaluate flow rates of the shallow water-bearing zone. Well Development Records that summarize this information are provided in Appendix E.

3.3.3 Water Level Measurements

Static water level measurements were collected after all well development activities had been completed. Measurements were recorded from top-of-casing (TOC) reference points marked on the PVC casing at each existing and newly-installed well. Water level measurements were collected on March 28, April 10, May 10, and August 18, 1995. Groundwater measurements were recorded using an electric measuring tape which were recorded to the nearest 0.01 foot. Water level data from site monitoring wells and staff gauges were collected within a three-hour period. A summary of water level measurements is provided in Table 3-5.

3.3.4 Aquifer Testing

Well-head tests (i.e., slug tests) were performed on selected wells at Site 54 as part of the groundwater investigation. Aquifer testing results, provided in Appendix N. Both falling- and rising-head tests were performed to approximate individual well characteristics and to provide generalized information regarding aquifer parameters within the study area.

3.3.5 Sampling Locations

Groundwater samples were collected from three existing shallow wells (54-GW01, 54-GW02, and 54-GW03), the seven newly installed shallow wells (54-GW04 through 54-GW10), and seven temporary wells (54-TW01 through 54-TW07) at Site 54. The locations of the newly installed, temporary, and existing monitoring wells are shown on Figure 3-2. The groundwater sampling round was conducted at Site 54 in April of 1995.

Three of the new permanent wells (54-GW05, 54-GW06, and 54-GW07) were placed within the study area, surrounding the burn pit. During March of 1995 groundwater samples were submitted for laboratory analysis from three existing, three temporary, and four newly installed monitoring wells. Based upon results of this initial groundwater sampling event and the analytical data generated during the soil investigation, an additional three permanent and four temporary monitoring wells were added to the groundwater investigation at Site 54. The three supplemental permanent wells (54-GW08, 54-GW09, and 54-GW10) were situated to the west and southwest of the burn pit, in the suspected direction of groundwater flow. One of the three additional wells, a Type III shallow well (54-GW08), was constructed to intercept groundwater below a confining or semi-confining layer. The four supplemental temporary wells were placed immediately adjacent to an on-site 8,000-gallon UST which is used for temporary storage of waste fuels. Figure 3-2 depicts the 17 groundwater sampling locations at Site 54.

3.3.6 Sampling Procedures

Groundwater samples were collected to assess whether contamination was present in the shallow aquifer, which may have resulted from previous and ongoing operations at Site 54. Based upon preceding investigative results and historical records, the contaminants of concern were volatiles, semivolatiles, petroleum hydrocarbons, and metals. Accordingly, the sampling program initiated at Site 54 focused on these contaminants.

Prior to groundwater purging, a water level measurement from each well was obtained according to procedures outlined in Section 3.3.3. The total well depth was also recorded from each well to the nearest 0.1 foot using a decontaminated steel tape. Water level and well depth measurements were used to calculate the volume of water in each well and the volume of water necessary to purge the well.

A minimum of three to five well volumes were purged from each well prior to sampling. Measurements of pH, specific conductance, temperature, and turbidity were taken after each well volume was purged to ensure that the groundwater characteristics had stabilized before sampling. These measurements were recorded in a field logbook and are provided in Table 3-6. Purge water was contained and handled as described in Section 3.6.

During the groundwater sampling event, a low flow well purging and sampling technique was employed. The sampling methodology was developed in response to conversations with USEPA Region IV personnel in Athens, Georgia. A peristaltic pump (GeoPump), with the intake set two to three feet into the static water column, was used to purge each of the wells. While purging groundwater from each of the monitoring wells, a flow rate of less than 0.25 gallons per minute (gpm) was maintained. Samples collected for both organic and metal analyses were obtained directly from the pump discharge. The Teflon™ tubing was decontaminated with a Liquinox soap solution and thoroughly rinsed with deionized water (refer to Section 3.5 for decontamination procedures). A dedicated one-foot section of silicon pump-head tubing was used during purge and sampling activities at each well. Rinsate blanks were collected from the Teflon™ and silicon tubing to verify that proper decontamination procedures were being followed.

Preparation of groundwater samples incorporated procedures similar to those described for soil samples. Sample information, including well number, sample identification, time and date of sample collection, samplers, analytical parameters, and required laboratory turnaround time, was recorded

in a field logbook and on the sample labels. Chain-of-custody documentation (provided in Appendix D) accompanied the samples to the laboratory.

3.3.7 Analytical Program

Groundwater samples from three existing shallow wells, seven newly installed shallow wells, and seven temporary wells were submitted for laboratory analysis from Site 54. Samples from each of the ten permanent wells (54-GW01 through 54-GW10) and the three temporary wells adjacent to the burn pit (54-TW01 through 54-TW03) were analyzed for full TCL organics (i.e., volatiles, semivolatiles, pesticides, and PCBs), TAL total metals, total suspended solids (TSS), and total dissolved solids (TDS). In addition, the groundwater samples obtained from 54-TW02 and 54-GW06 were also analyzed for TAL dissolved metals. The four remaining temporary wells, placed adjacent to an on-site UST, were analyzed for TCL volatiles and TCL semivolatiles only. Table 3-7 provides a summary of groundwater samples submitted for laboratory analysis during the groundwater investigation. The groundwater samples were analyzed using Contract Laboratory Program (CLP) protocols and Level IV data quality.

3.3.8 Quality Assurance and Quality Control

Field QA/QC samples were also submitted for analyses during the groundwater investigation. These samples included trip blanks, equipment rinsates, and duplicates. Equipment rinsates were collected from the peristaltic pump and Teflon™ tubing after decontamination was completed and prior to reuse. Section 3.2.4 provides a summary of QA/QC samples collected during the investigation. Table 3-8 summarizes the QA/QC sampling program employed for the groundwater investigation conducted at Site 54.

3.3.9 Field Screening and Air Monitoring

Air monitoring and field screening procedures for volatile organic vapors implemented at Site 54 included the screening of well heads and the purged groundwater with a PID. Measurements obtained in the field were recorded in a field logbook. Prior to daily monitoring, the field instruments were calibrated and documentation was recorded in a field logbook and on calibration forms.

3.4 Habitat Evaluation

During the habitat evaluation at Site 54, dominant vegetation types and species were identified in the field; those plants that could not be readily identified were collected for further examination in the office. Amphibians, reptiles, birds, and mammals were also identified as visual sightings or evidence allowed. In many cases, the animals themselves were not seen, but scat, tracks, feeding areas, or remains were noted. From this information, ecological communities were established and biohabitat maps developed (see Section 2.0).

3.5 Decontamination Procedures

Decontamination procedures performed in the field were initiated in accordance with USEPA Region IV SOPs. Sampling and drilling equipment were divided into two decontamination groups, heavy equipment and routine sample collection equipment. Heavy equipment included the drill rig, hollow-stem augers, and drill and sampling rods. Routine sample collection equipment included

split spoons, stainless steel core barrels (used with the GeoProbe™), and stainless steel spoons and bowls, and Teflon™ tubing.

The following procedures were implemented for heavy equipment:

- Removal of caked-on soil with brush
- Steam clean with high-pressure steam
- Air dry

The following procedures were implemented for routine sample collection equipment:

- Clean with distilled water and laboratory detergent (Liquinox soap solution)
- Rinse thoroughly with distilled water
- Rinse twice with isopropyl alcohol
- Air dry
- Wrap in aluminum foil, if appropriate

Temporary decontamination pads, constructed of wood and plastic, were constructed to prevent spillage of fluids onto the ground surface. Decontamination fluids generated during the field program were containerized and handled according to the procedures outlined in Section 3.8.

3.6 Investigation Derived Waste (IDW) Handling

Field investigation activities at Site 54 resulted in the generation of various IDW. This IDW included drilling mud, soil cuttings, well development and purge water, and solutions used to decontaminate non-disposable sampling equipment. The general management techniques utilized for the IDW were:

1. Collection and containerization of IDW material.
2. Temporary storage of IDW while awaiting confirmatory analytical data.
3. Final disposal of aqueous and solid IDW material.

The management of the IDW was performed in accordance with guidelines developed by the USEPA Office of Emergency and Remedial Response, Hazardous Site Control Division (USEPA, 1992). Both the IDW soils and water were returned, based on confirmatory analytical data, to their respective source areas. Contaminated wastewater was sent off site to a licensed hazardous waste disposal facility. Appendix F provides information regarding the management and disposal of the IDW.

3.7 References

American Society for Testing and Materials (ASTM). 1993. Standard Practice for Description and Identification of Soils (Visual Manual Procedure). ASTM D-2488-93. American Society for Testing and Materials, Philadelphia, Pennsylvania.

Baker Environmental, Inc. 1994. Remedial Investigation/Feasibility Study Work Plan for Operable Unit No. 6 (Sites 43, 43, 54, 54, and 86), Marine Corps Base Camp Lejeune, North Carolina. Final. Prepared for the Department of the Navy, Naval Facilities Engineering Command, Atlantic Division, Norfolk, Virginia. December 1994.

Environmental Science and Engineering, Inc. (ESE) 1990. Site Summary Report. Final. Marine Corps Base, Camp Lejeune, North Carolina. Prepared for the Department of the Navy, Naval Facilities Engineering Command, Atlantic Division, Norfolk, Virginia. ESE Project No. 49-02043. September 1990.

Naval Energy and Environmental Support Activity (NEESA). 1988. Sampling and Chemical Analysis Quality Assurance Requirements for the Navy Installation Restoration Program. Department of the Navy, Naval Energy and Environmental Support Activity, Port Hueneme, California. NEESA 20.2-047B.

United States Environmental Protection Agency (USEPA). 1991. National Functional Guidelines for Organic Data Review. Draft. USEPA Contract Laboratory Program. June 1991.

United States Environmental Protection Agency (USEPA). 1992. Guide to Management of Investigation-Derived Wastes. Office of Emergency and Remedial Response Hazardous Site Control Division. Washington, D.C. OS-220W. April 1992.

SECTION 3.0 TABLES

TABLE 3-1

**SOIL SAMPLING SUMMARY
TEST BORINGS
SITE 54, CRASH CREW FIRE TRAINING BURN PIT
REMEDIAL INVESTIGATION, CTO-0303
MCAS, NEW RIVER, NORTH CAROLINA**

Sample Location	Depth of Borehole (feet, bgs)	Sampling Interval (feet, bgs)	Analytical Parameters										
			TCL Pest/PCB	TAL Metals	TPH	TCL VOC	TCL SVOC	Grain Size	Atterburg Limtis	Immuno-assay ⁽¹⁾	Duplicate Sample	MS/MSD	
54-ES01	4	0-4									X		
54-ES02	4	1-2									X		
54-ES03	4	0-4									X		
54-ES04	4	1.5-2									X		
54-ES05	4	0-4									X		
54-ES06	4	0-4									X		
54-ES07	4	0-4									X		
54-ES08	4	0.8-1.7									X		
54-ES09	4	0-4									X		
54-ES10	4	0-4	X			X	X				X		
54-ES11	4	0-4									X		
54-ES12	12	0-4	X			X	X	X	X		X		
54-ES13	4	0-4									X		
54-ES14	4	0-4									X		
54-ES15	4	1-2.9	X			X	X				X		
54-ES16	4	0-4									X		
54-ES17	4	0-4									X		
54-ES18	4	0-4	X			X	X				X		
54-SB01	10	0-1			X	X	X						
		7-9			X	X	X						
54-SB02	9	1-3			X	X	X						
		7-9			X	X	X						
54-SB03	9	1-3	X	X	X	X	X						
		7-9	X	X	X	X	X						

TABLE 3-1 (Continued)

SOIL SAMPLING SUMMARY
 TEST BORINGS
 SITE 54, CRASH CREW FIRE TRAINING BURN PIT
 REMEDIAL INVESTIGATION, CTO-0303
 MCAS, NEW RIVER, NORTH CAROLINA

Sample Location	Depth of Borehole (feet, bgs)	Sampling Interval (feet, bgs)	Analytical Parameters										
			TCL Pest/PCB	TAL Metals	TPH	TCL VOC	TCL SVOC	Grain Size	Atterburg Limtis	Immuno-assay ⁽¹⁾	Duplicate Sample	MS/MSD	
54-SB04	11	0-1			X	X	X						
		7-9			X	X	X						
54-SB05	10	1-3	X	X	X	X	X						
		7-9	X	X	X	X	X						
54-SB06	10	0-1			X	X	X						
		3-5			X	X	X						
		9-10			X	X	X						
54-SB07	12	0-1			X	X	X						
		9-10			X	X	X						
54-SB08	11	0-1			X	X	X						
		1-3			X	X	X						
		7-9			X	X	X						
54-SB09	9	0-1			X	X	X						
		5-7			X	X	X						
54-DD-SB01	7	0-1	X	X		X	X					X	X
		3-5	X	X		X	X						
54-DD-SB02	7	0-1	X	X		X	X						
		3-5	X	X		X	X						
54-DD-SB03	5	0-1	X	X		X	X						
		1-3	X	X		X	X						
54-DD-SB04	5	0-1	X	X		X	X						
		1-3	X	X		X	X						
54-DD-SB05	5	0-1			X	X	X						
		1-3			X	X	X						

TABLE 3-1 (Continued)

**SOIL SAMPLING SUMMARY
TEST BORINGS
SITE 54, CRASH CREW FIRE TRAINING BURN PIT
REMEDIAL INVESTIGATION, CTO-0303
MCAS, NEW RIVER, NORTH CAROLINA**

Sample Location	Depth of Borehole (feet, bgs)	Sampling Interval (feet, bgs)	Analytical Parameters									
			TCL Pest/PCB	TAL Metals	TPH	TCL VOC	TCL SVOC	Grain Size	Atterburg Limtis	Immuno-assay ⁽¹⁾	Duplicate Sample	MS/MSD
54-BB-SB01 ⁽²⁾	11	0-1	X	X		X	X					
		7-9	X	X		X	X					
54-BB-SB02 ⁽²⁾	11	0-1	X	X		X	X					

Notes: ⁽¹⁾ Soil samples were analyzed for petroleum hydrocarbons using an immunoassay field test (USEPA Method 4030).

⁽²⁾ Background or control sample location.

TPH - Total Petroleum Hydrocarbons

TABLE 3-2

**SOIL SAMPLING SUMMARY
MONITORING WELL TEST BORINGS
SITE 54, CRASH CREW FIRE TRAINING BURN PIT
REMEDIAL INVESTIGATION, CTO-0303
MCAS, NEW RIVER, NORTH CAROLINA**

Sample Location	Depth of Borehole (feet, bgs)	Sampling Interval (feet, bgs)	Analytical Parameters	
			Grain Size	Atterburg Limits
54-TW02	12	0-12	X	X
54-GW04	18	0-4	X	X

TABLE 3-3

QUALITY ASSURANCE/QUALITY CONTROL SAMPLING PROGRAM
 SOIL INVESTIGATION
 SITE 54, CRASH CREW FIRE TRAINING BURN PIT
 REMEDIAL INVESTIGATION, CTO-0303
 MCAS, NEW RIVER, NORTH CAROLINA

QA/QC Sample ⁽¹⁾	Frequency of Collection	Number of Samples	Analytical Parameters
Trip Blanks ⁽²⁾	One per cooler	4	TCL Volatiles
Equipment Rinsates ⁽³⁾	One per day	3	TCL VOA, TCL SVOA, TCL PEST/PCB, TAL Metals
Field Duplicates ⁽⁴⁾	10% of sample frequency	2	TCL VOA, TCL SVOA, TCL PEST/PCB, TAL Metals, TPH

- Notes:
- (1) QA/QC sample types defined in Section 3.2.4 in text.
 - (2) Trip blanks submitted with coolers which contained samples for volatile analysis. Samples analyzed for TCL Volatiles only.
 - (3) Equipment rinsates collected from various sampling equipment (e.g., stainless steel spoons).
 - (4) Field duplicate samples presented in Appendix J.

TABLE 3-4

SUMMARY OF WELL CONSTRUCTION DETAILS
 SITE 54, CRASH CREW FIRE TRAINING BURN PIT
 REMEDIAL INVESTIGATION, CTO-0303
 MCAS, NEW RIVER, NORTH CAROLINA

Well No.	Date Installed	Top of PVC Casing Elevation (feet, above msl) ⁽¹⁾	Ground Surface Elevation (feet, above msl)	Boring Depth (feet, below ground surface)	Well Depth (feet, below ground surface)	Screen Interval Depth (feet, below ground surface)	Sand Pack Interval Depth (feet, below ground surface)	Bentonite Interval Depth (feet, below ground surface)
54-TW01	3/12/95	NA	20.80	12	13	8-13	NA	NA
54-TW02	3/12/95	NA	20.70	12	12	7-12	NA	NA
54-TW03	3/12/95	NA	21.10	14	11.5	6.5-11.5	NA	NA
54-TW04	4/10/95	NA	19.94	14.5	14	4-14	NA	NA
54-TW05	4/10/95	NA	19.94	14.5	14	4-14	NA	NA
54-TW06	4/10/95	NA	19.94	14.5	14	4-14	NA	NA
54-TW07	4/11/95	NA	19.94	14.5	14	4-14	NA	NA
54-GW04	3/7/95	15.12	12.31	18	17.5	2-17	1-18	0-1
54-GW05	3/24/95	19.37	19.62	20	19.5	14-19	10.5-20	4-10.5
54-GW06	3/25/95	20.77	21.22	18	16	11-16	7.5-18	4-7.5
54-GW07	3/24/95	21.47	21.92	35.5	35	25-35	20-35.5	10-20
54-GW08	4/8/95	20.99	21.12	29.5	29.5	24-29	22-29.5	18-22
54-GW09	4/7/95	18.77	18.92	12	12	6.5-11.5	5-12	3-5
54-GW10	4/7/95	19.43	19.52	13	13	7.5-12.5	6-13	4-6

Notes: ⁽¹⁾ msl = mean sea level

Horizontal positions are referenced to N.C. State Plane Coordinate System (NAD 27) CF = 0.9999216 from USMC Monument Toney.

Vertical datum NGVD 29.

NA - Not Applicable

TABLE 3-5

SUMMARY OF WATER LEVEL MEASUREMENTS
 SITE 54, CRASH CREW FIRE TRAINING BURN PIT
 REMEDIAL INVESTIGATION, CTO-0303
 MCAS, NEW RIVER, NORTH CAROLINA

Well No.	Top of PVC Casing Elevation (feet, above msl) ⁽¹⁾	Depth to Groundwater (feet, below top of casing) March 28, 1995	Depth to Groundwater (feet, below top of casing) April 10, 1995	Depth to Groundwater (feet, below top of casing) May 10, 1995	Depth to Groundwater (feet, below top of casing) August 18, 1995	Groundwater Elevation (feet, above msl) March 28, 1995	Groundwater Elevation (feet, above msl) April 10, 1995	Groundwater Elevation (feet, above msl) May 10, 1995	Groundwater Elevation (feet, above msl) August 18, 1995
54-GW01	20.39	9.22	9.22	10.13	10.30	11.17	11.17	10.26	10.09
54-GW02	23.83	11.50	11.78	12.24	12.46	12.33	12.05	11.59	11.37
54-GW03	13.38	3.70	4.04	4.86	4.60	9.68	9.34	8.52	8.78
54-GW04	15.12	3.83	4.08	4.54	5.42	11.29	11.04	10.58	9.70
54-GW05	19.37	7.82	8.08	8.52	8.72	11.55	11.29	10.85	10.65
54-GW06	20.77	9.22	9.45	9.86	10.14	11.55	11.32	10.91	10.63
54-GW07	21.47	9.32	9.62	10.12	10.28	12.15	11.85	11.35	11.19
54-GW08	20.99	NA	11.61	12.20	12.11	NA	9.38	8.79	8.88
54-GW09	18.77	NA	8.28	8.71	8.99	NA	10.49	10.06	9.78
54-GW10	19.43	NA	8.92	9.43	9.6	NA	10.51	10.00	9.83
54-SG01 ⁽²⁾	8.97	0.92	NA	0.32	NA	6.55	NA	5.95	NA

Notes:

⁽¹⁾ msl = mean sea level

⁽²⁾ Staff gauge

NA - Data not available

TABLE 3-6

SUMMARY OF GROUNDWATER FIELD PARAMETERS
 SITE 54, CRASH CREW FIRE TRAINING BURN PIT
 REMEDIAL INVESTIGATION, CTO-0303
 MCAS, NEW RIVER, NORTH CAROLINA

Well No.	Depth of Well (ft.)	Purge Volume (gals.)	Field Parameters				
Date of Measurement			Well Volume	Specific Conductance at 25°C (micromhos/cm)	Temperature (°C)	pH (S.U.)	Turbidity (T.U.)
54-GW01	17.11	7.8	0	104.0	18.0	5.21	0.3
3/28/95			1.0	102.0	18.0	5.21	31.6
			2.0	102.0	18.0	5.27	31.4
			3.0	103.0	17.9	5.31	17.2
			4.0	103.0	17.9	5.32	13.1
			5.0	103.0	18.0	5.33	0.0
			6.0	102.0	18.2	5.33	4.9
54-GW02	27.65	7.8	0.5	402.0	18.0	6.26	35.2
3/28/95			1.0	448.0	18.0	6.44	17.8
			1.5	471.0	18.0	6.49	10.2
			2.0	483.0	18.0	6.52	4.3
			2.5	484.0	18.5	6.54	2.5
			3.0	494.0	18.0	6.59	1.7
54-GW03	27.6	11.5	0.5	517.0	18.0	6.98	27.6
3/28/95			1.0	524.0	18.5	7.00	23.5
			1.5	537.0	19.0	7.01	17.5
			2.0	532.0	19.0	7.03	12.7
			2.5	527.0	19.5	7.04	8.9
			3.0	532.0	19.0	7.09	6.0
54-GW04	19.7	7.62	0.5	120.0	18.0	5.26	31.5
3/28/95			1.0	127.0	17.5	5.28	14.4
			1.5	121.0	17.5	5.27	6.9
			2.0	120.0	18.0	5.26	3.1
			2.5	123.0	19.0	5.30	3.0
			3.0	123.0	19.0	5.27	1.9

TABLE 3-6 (Continued)

SUMMARY OF GROUNDWATER FIELD PARAMETERS
 SITE 54, CRASH CREW FIRE TRAINING BURN PIT
 REMEDIAL INVESTIGATION, CTO-0303
 MCAS, NEW RIVER, NORTH CAROLINA

Well No.	Depth of Well (ft.)	Purge Volume (gals.)	Field Parameters				
Date of Measurement			Well Volume	Specific Conductance at 25°C (micromhos/cm)	Temperature (°C)	pH (S.U.)	Turbidity (T.U.)
54-GW05	19.5	6.0	0	132.0	16.0	5.11	8.5
3/28/95			0.5	126.0	16.0	5.17	0.1
			1.0	129.0	16.0	5.29	0.1
			1.5	124.0	15.9	5.39	2.4
			2.0	121.0	15.9	5.42	1.9
			2.5	110.0	16.0	5.47	1.8
			3.0	116.0	16.0	5.55	1.3
54-GW06	16.0	7.2	0	135.0	18.5	5.48	128.5
3/28/95			1.0	132.0	18.0	5.41	29.8
			2.0	128.0	18.1	5.38	10.8
			3.0	127.0	18.5	5.38	6.3
			4.0	133.0	18.9	5.36	38.5
			5.0	129.0	18.7	5.36	4.9
			6.0	133.0	18.9	5.36	2.9
54-GW07	35.5	13.5	0	388.0	18.0	6.14	58.9
3/28/95			0.5	374.0	19.9	6.63	40.9
			1.0	390.0	20.0	6.75	16.5
			1.5	387.0	20.0	6.96	0.4
			2.0	388.0	20.0	7.09	0.2
			2.5	390.0	20.0	7.16	10.9
			3.0	388.0	20.1	7.28	8.2
54-GW08	29.0	8.25	0.5	396.0	20.0	7.46	50.3
4/18/95			1.0	394.0	21.0	7.44	41.3
			1.5	407.0	21.5	7.47	25.5
			2.0	408.0	22.5	7.42	15.5
			2.5	410.0	22.1	7.47	7.5
			3.0	410.0	22.9	7.45	3.7

TABLE 3-6 (Continued)

SUMMARY OF GROUNDWATER FIELD PARAMETERS
 SITE 54, CRASH CREW FIRE TRAINING BURN PIT
 REMEDIAL INVESTIGATION, CTO-0303
 MCAS, NEW RIVER, NORTH CAROLINA

Well No.	Depth of Well (ft.)	Purge Volume (gals.)	Field Parameters				
Date of Measurement			Well Volume	Specific Conductance at 25°C (micromhos/cm)	Temperature (°C)	pH (S.U.)	Turbidity (T.U.)
54-GW09	12.0	1.8	1.0	105.0	17.0	4.33	16.5
4/18/95			2.0	100.0	17.0	4.40	2.7
			3.0	102.0	16.0	4.46	0.8
54-GW10	13.0	3.78	0.5	NA	NA	NA	NA
4/17/95			1.0	89.0	28.0	4.91	41.6
			2.0	92.0	28.3	4.90	31.4
			3.0	89.0	28.0	4.83	42.0
			4.0	113.0	23.4	4.76	32.0
			5.0	93.0	23.5	4.92	21.2
			5.5	NA	NA	NA	23.1
			6.0	NA	NA	NA	25.5
54-TW01	13.6	2.0	NA	190.0	19.5	5.27	NA
3/12/95			NA	187.0	20.0	5.21	NA
			NA	181.0	20.0	5.22	NA
			NA	192.0	20.5	5.24	NA
			NA	181.0	20.0	5.26	2.70
54-TW02	12.0	2.0	NA	227.0	15.0	6.24	>200.0
3/12/95			NA	159.0	14.9	5.91	>200.0
			NA	178.0	15.0	5.94	>200.0
			NA	141.0	15.0	5.85	29.2
			NA	150.0	15.0	5.79	6.5
			NA	156.0	15.0	5.80	2.5
54-TW03	14.02	2.5	NA	403.0	18.0	6.43	189.6
3/12/95			NA	345.0	16.0	6.13	27.3
			NA	378.0	16.0	6.19	11.3
			NA	406.0	15.5	6.23	13.0
			NA	410.0	16.0	6.21	5.0
			NA	403.0	16.0	6.27	2.9

TABLE 3-6 (Continued)

SUMMARY OF GROUNDWATER FIELD PARAMETERS
 SITE 54, CRASH CREW FIRE TRAINING BURN PIT
 REMEDIAL INVESTIGATION, CTO-0303
 MCAS, NEW RIVER, NORTH CAROLINA

Well No.	Depth of Well (ft.)	Purge Volume (gals.)	Field Parameters				
Date of Measurement			Well Volume	Specific Conductance at 25°C (micromhos/cm)	Temperature (°C)	pH (S.U.)	Turbidity (T.U.)
54-TW04	15.0	NA	NA	810.0	21.0	6.83	>200.0
4/11/95			NA	768.0	20.0	6.85	62.0
			NA	817.0	20.5	6.88	17.7
			NA	817.0	20.5	6.87	22.4
			NA	795.0	20.0	6.89	45.3
54-TW05	15.0	NA	NA	116.0	15.0	4.92	111.4
4/11/95			NA	120.0	16.0	4.97	10.5
			NA	119.0	16.5	4.99	14.9
			NA	118.0	17.0	5.02	36.5
			NA	115.0	18.0	4.98	10.4
54-TW-06	15.0	NA	NA	135	15.0	4.02	>200.0
4/11/95			NA	135	15.0	3.97	NA
			NA	135	15.0	3.97	NA
			NA	135	15.0	4.01	NA
			NA	135	15.0	4.00	1.8
54-TW07	15.0	NA	NA	193.0	18.5	4.68	135.2
4/22/95			NA	195.0	18.0	4.64	20.6
			NA	195.0	18.0	4.66	11.6
			NA	195.0	18.0	4.65	10.3

Notes: S.U. - Standard Units
 T.U. - Turbidity Units

TABLE 3-7

GROUNDWATER SAMPLING SUMMARY
 SITE 54, CRASH CREW FIRE TRAINING BURN PIT
 REMEDIAL INVESTIGATION, CTO-0303
 MCAS, NEW RIVER, NORTH CAROLINA

Sample Location	Analytical Parameters							Duplicate Sample
	TCL VOC	TCL SVOC	TCL Pest/ PCB	TAL Metals	Dissolved TAL Metals	TSS	TDS	
54-TW01	X	X	X	X		X	X	
54-TW02	X	X	X	X	X	X	X	
54-TW03	X	X	X	X		X	X	
54-TW04	X	X						
54-TW05	X	X						
54-TW06	X	X						
54-TW07	X	X						
54-GW01	X	X	X	X		X	X	
54-GW02	X	X	X	X		X	X	
54-GW03	X	X	X	X		X	X	
54-GW04	X	X	X	X		X	X	X
54-GW05	X	X	X	X		X	X	
54-GW06	X	X	X	X	X	X	X	
54-GW07	X	X	X	X		X	X	
54-GW08	X	X	X	X		X	X	
54-GW09	X	X	X	X		X	X	X
54-GW10	X	X	X	X		X	X	

Notes: TSS - Total Suspended Solids
 TDS - Total Dissolved Solids

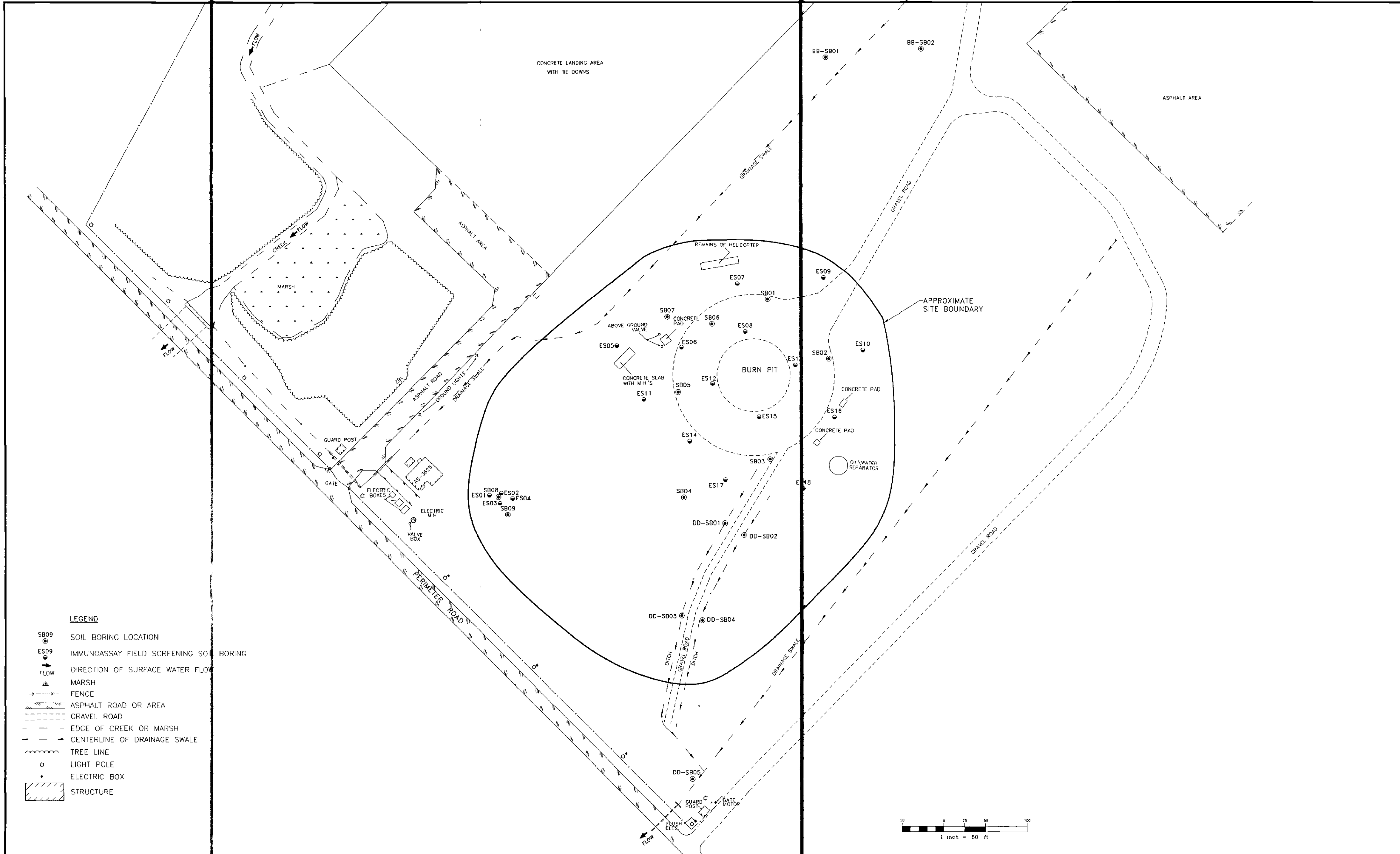
TABLE 3-8

**QUALITY ASSURANCE/QUALITY CONTROL SAMPLING PROGRAM
GROUNDWATER INVESTIGATION
SITE 54, CRASH CREW FIRE TRAINING BURN PIT
REMEDIAL INVESTIGATION, CTO-0303
MCAS, NEW RIVER, NORTH CAROLINA**

QA/QC Sample ⁽¹⁾	Frequency of Collection	Number of Samples	Analytical Parameters
Trip Blanks ⁽²⁾	One per cooler	5	TCL Volatiles
Field Blanks ⁽³⁾	One per event	1	TCL VOA, TCL SVOA, TCL PEST/PCB, TAL Metals
Equipment Rinsates ⁽⁴⁾	One per day	2	TCL VOA, TCL SVOA, TCL PEST/PCB, TAL Metals, TSS, TDS
Field Duplicates ⁽⁵⁾	10% of sample frequency	2	TCL VOA, TCL SVOA, TCL PEST/PCB, TAL Metals, TSS, TDS

- Notes:
- (1) QA/QC sample types defined in Section 3.2.4 in text.
 - (2) Trip blanks submitted with coolers which contained samples for volatile analysis. Samples analyzed for TCL Volatiles only.
 - (3) Field blank collected during the groundwater investigation from water source used for decontamination.
 - (4) Equipment rinsates collected from various sampling equipment (e.g., peristaltic pump).
 - (5) Field duplicate samples presented in Appendix J.

SECTION 3.0 FIGURES



LEGEND

- SB09 SOIL BORING LOCATION
- ES09 IMMUNOASSAY FIELD SCREENING SOIL BORING
- FLOW DIRECTION OF SURFACE WATER FLOW
- MARSH
- FENCE
- ASPHALT ROAD OR AREA
- GRAVEL ROAD
- EDGE OF CREEK OR MARSH
- CENTERLINE OF DRAINAGE SWALE
- TREE LINE
- LIGHT POLE
- ELECTRIC BOX
- STRUCTURE

REVISIONS

DRAWN	REL
REVIEWED	TFT/JEZ
S.O #	303-0000-07000
CADD#	303030RI



REMEDIAL INVESTIGATION CTG-0303
MARINE CORPS AIR STATION, NEW RIVER
NORTH CAROLINA

BAKER ENVIRONMENTAL, Inc.
Coraopolis, Pennsylvania



SURFACE AND SUBSURFACE SOIL
SAMPLING LOCATIONS
SITE 54, CRASH CREW FIRE TRAINING BURN PIT

SCALE	1" = 50'	DATE	JANUARY 1996
-------	----------	------	--------------

FIGURE No.
3-1

SOURCE: LANTDIV, FEBRUARY 1992
SURVEY: BRENT A. LANIER AND ASSOCIATES, 1995

01717AA03X

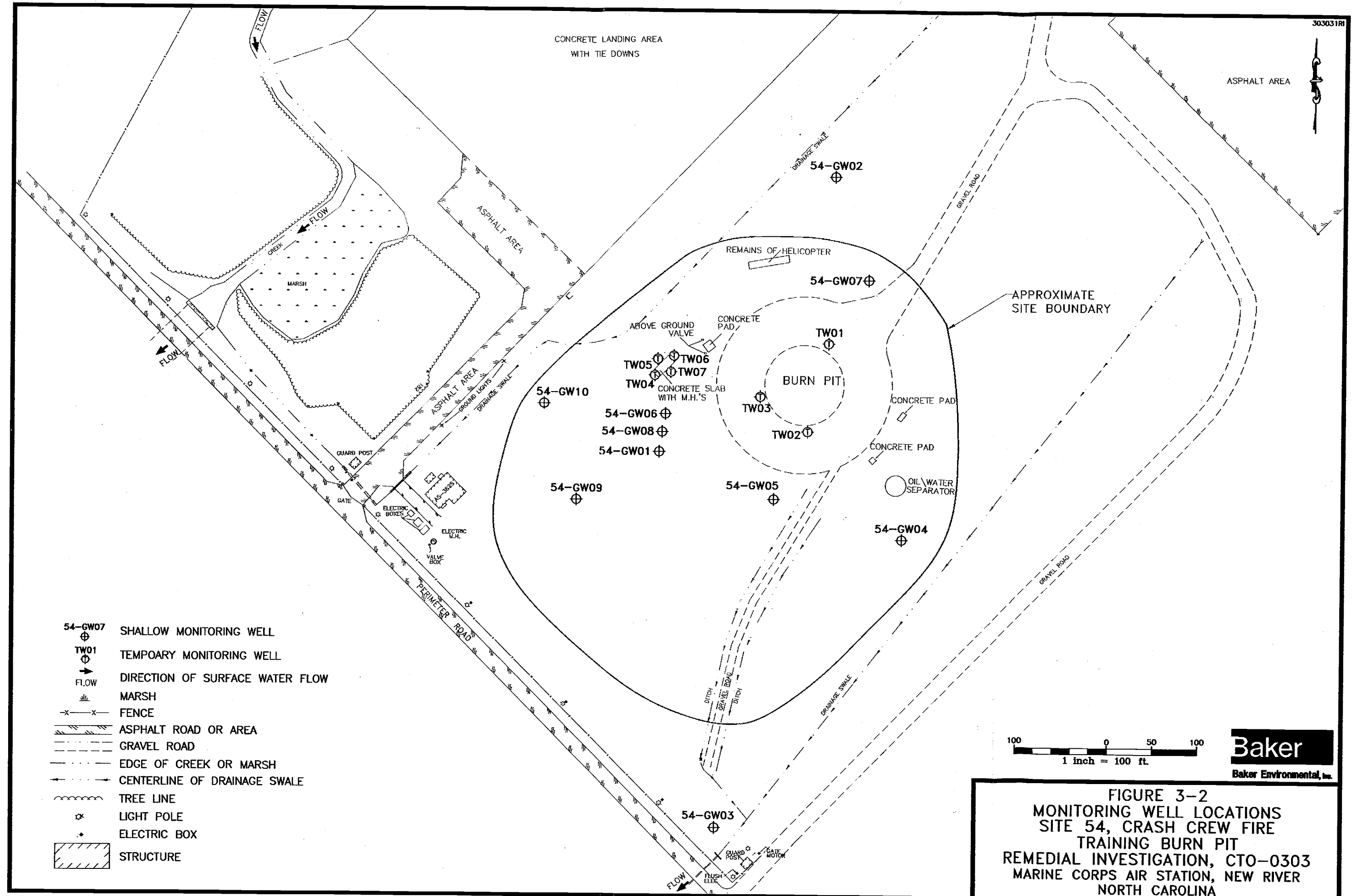
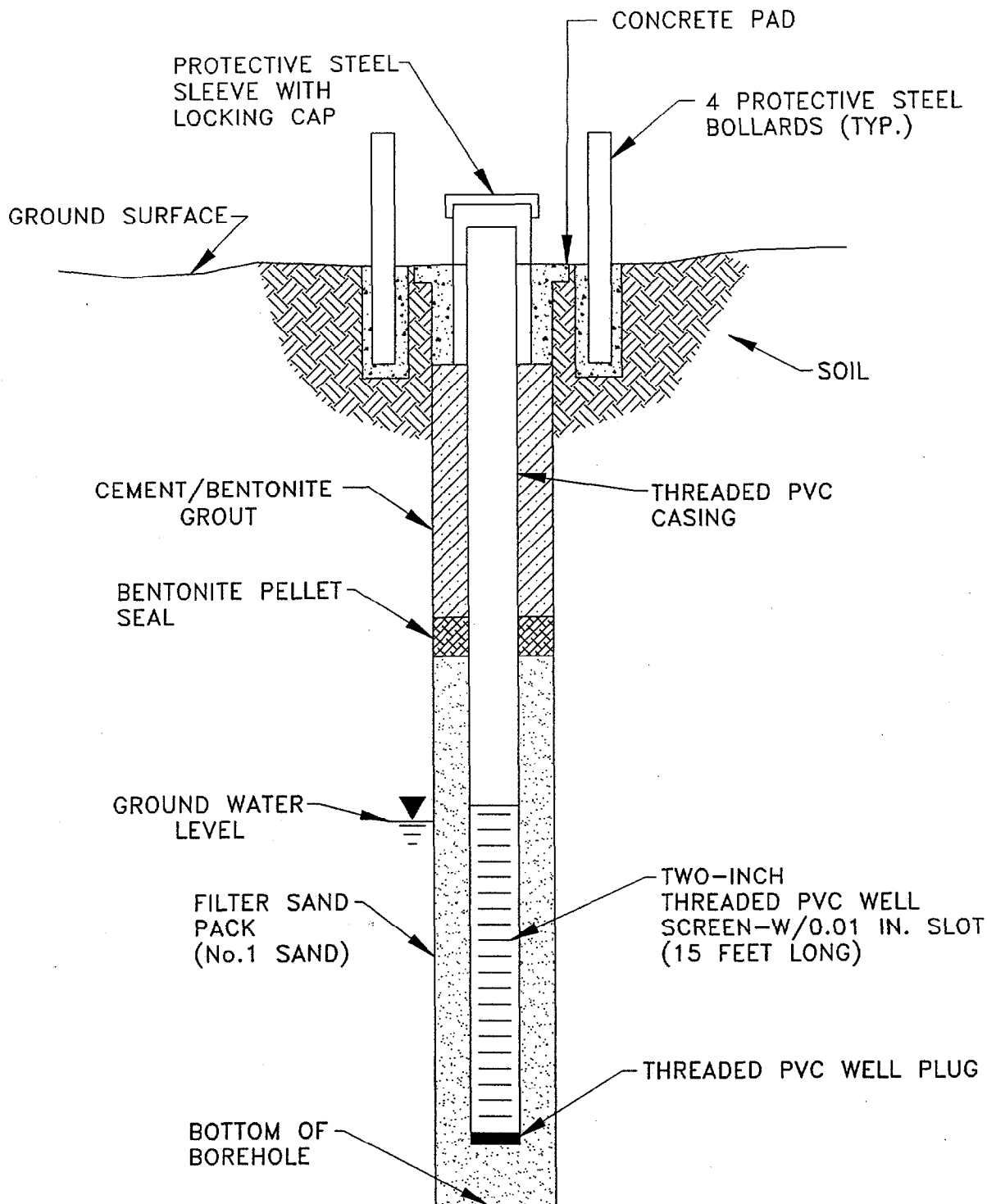


FIGURE 3-2
MONITORING WELL LOCATIONS
SITE 54, CRASH CREW FIRE
TRAINING BURN PIT
REMEDIAL INVESTIGATION, CTO-0303
MARINE CORPS AIR STATION, NEW RIVER
NORTH CAROLINA

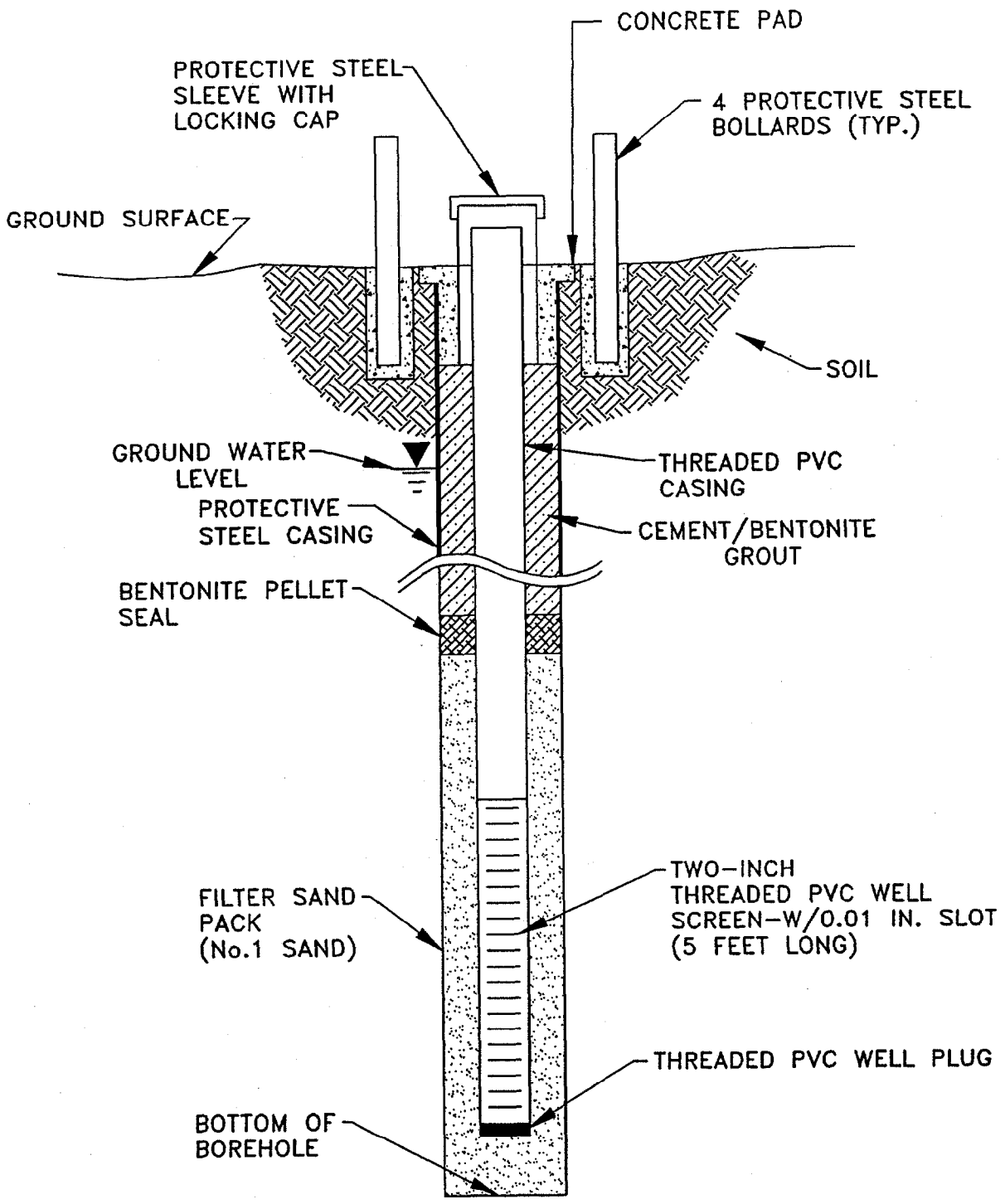
01717A04Z



N.T.S.

Baker
Baker Environmental, Inc.

FIGURE 3-3
TYPICAL SHALLOW TYPE II GROUNDWATER
MONITORING WELL CONSTRUCTION DIAGRAM
REMEDIAL INVESTIGATION CTO-0303
MARINE CORPS BASE, CAMP LEJEUNE
NORTH CAROLINA



N.T.S.



FIGURE 3-4
TYPICAL SHALLOW TYPE III GROUNDWATER
MONITORING WELL CONSTRUCTION DIAGRAM
REMEDIAL INVESTIGATION CTO-0303
MARINE CORPS BASE, CAMP LEJEUNE
NORTH CAROLINA

4.0 NATURE AND EXTENT OF CONTAMINATION

This section presents the nature and extent of contamination at OU No. 6, Site 54. The objective of this section is to characterize the nature and extent of contamination which may be present as a result of past waste management activities. The characterization of contaminants at Site 54 was performed by sampling and laboratory analysis of soil and groundwater environmental media. Appendices G through M present the Sampling Summaries; Data and Frequency Summaries; Statistical Summaries; Field Duplicate Summaries; Quality Assurance and Quality Control Summaries; TCLP and RCRA Results; and Engineering Parameter Results for the various media at Site 54.

4.1 Data Quality

The majority of data generated during the RI was submitted for third-party validation; wet chemistry, TPH, grain size, and permeability results were not validated. The usability of the data was determined by the third party data validator, Heartland Environmental Services, Inc. Procedures stipulated by the National Functional Guidelines for Organic (USEPA, 1991) and Inorganic (USEPA, 1988) Analyses were observed during the validation process. Validation of the analytical data serves to reduce the inherent uncertainties associated with its usability. Data qualified as "J" were retained as estimated. Estimated analytical results within a data set are common and considered to be usable by the USEPA (USEPA, 1989). Data may be qualified as estimated for several reasons including an exceedance of holding times, high or low surrogate recovery or intra-sample variability. In addition, values may be assigned an estimated "J" qualifier if the reported value is below the Contract Required Detection Limit (CRDL) or the Contract Required Quantitation Limit (CRQL). Data assigned a rejected "R" qualifier was excluded from the usable data set. Under these conditions estimated positive results were designated with "J" qualifiers and all rejected data were assigned "R" qualifiers. Table 4-1 provides a summary of all rejected Site 54 data.

Additional qualifiers were employed during the validation of data. The "NJ" qualifier denotes that a compound was tentatively identified, but the reported value may not be accurate or precise. Compounds that were not detected and had inaccurate or imprecise quantitation limits were assigned the "UJ" qualifier.

4.1.1 Data Management and Tracking

The management and tracking of data, from time of field collection to receipt of validation report, is of primary importance to the overall quality of laboratory analytical results. Field samples and their corresponding analyses were recorded on chain-of-custody forms, provided in Appendix D. Chain-of-custody forms were compared to the Field Sampling and Analysis Plan (Baker, 1994); this comparison was used to verify that appropriate laboratory analyses had been requested. Upon receipt of laboratory analytical results, a further comparison was performed to verify that each sample received by the laboratory was analyzed for the correct parameters. Finally, the validation report was compared to the requested laboratory analyses.

The management and tracking of data was used to determine the following items:

- Identify and correct chain-of-custody discrepancies prior to laboratory analysis
- Verify the receipt of all samples by the laboratory
- Confirm that requested sample analyses and validation were performed
- Ensure the delivery of a complete data set

4.2 Non-Site Related Analytical Results

Many of the organic compounds and inorganic analytes detected in environmental media at Site 54 may be attributable to non-site related conditions or activities. Two primary sources of non-site related analytical results include laboratory contaminants and naturally-occurring inorganic species. In addition, non-site related operational activities and conditions may contribute to "on-site" contamination. A discussion of non-site related analytical results for Site 54 is provided in the subsections which follow.

4.2.1 Laboratory Contaminants

Field blank and trip blank samples provide a measure of contamination that has been introduced into a sample set during the collection, transportation, preparation, or analysis of samples. To remove non-site related constituents from further consideration, the concentrations of chemicals detected in blanks were compared with concentrations of the same chemicals detected in environmental samples.

Common laboratory contaminants (i.e., acetone, 2-butanone, chloroform, methylene chloride, toluene, and phthalate esters) were retained for use in interpreting site conditions only when observed concentrations in any environmental sample exceeded ten times the maximum concentration detected in any blank. If the concentration of a common laboratory contaminant was less than ten times the maximum blank concentration, its presence among the data set was attributed to laboratory contamination in that particular sample and excluded from further evaluation (USEPA, 1989). The maximum concentrations of detected common laboratory contaminants in blanks were as follows:

●	Acetone	24 J $\mu\text{g/L}$
●	Chloroform	13 $\mu\text{g/L}$
●	2-Butanone	32 $\mu\text{g/L}$
●	bis-(2-Ethylhexyl)phthalate	280 J $\mu\text{g/L}$

Blanks containing organic constituents that were not considered common laboratory contaminants (i.e., all other TCL compounds) were retained in the site analytical database only when observed concentrations exceeded five times the maximum concentration detected in any QA/QC blank (USEPA, 1989). All TCL compounds detected at less than five times the maximum level of contamination noted in any QA/QC blank were attributed to blank contamination and excluded from further evaluation. The maximum concentrations of all other detected blank contaminants were as follows:

●	Bromodichloromethane	13 $\mu\text{g/L}$
●	Dibromochloromethane	10 $\mu\text{g/L}$

A limited number of environmental samples that exhibited high concentrations of tentatively identified compounds (TICs) were subjected to an additional sample preparation. Medium level sample preparation provides a corrected CRQL based on the volume of sample used for analysis. The corrected CRQL produces higher detection limits than the low level sample preparation. A comparison to laboratory blanks used in the medium level preparation was used to evaluate the relative amount of contamination within these samples.

4.2.2 Naturally-Occurring Inorganic Analytes

In order to differentiate between inorganic contamination due to site operations and naturally-occurring inorganic analytes in site media, the results of the sample analyses were compared to information regarding background conditions at MCB, Camp Lejeune. The following guidelines were used for each media:

Soil:	MCB, Camp Lejeune Background Soil Samples
Groundwater:	MCB, Camp Lejeune Background Groundwater Samples
Surface Water:	MCB, Camp Lejeune Background Surface Water Samples
Sediment:	MCB, Camp Lejeune Background Sediment Samples

The following subsections address the various comparison criteria used to evaluate soil, groundwater, surface water, and sediment analytical results from samples collected at Site 54.

4.2.2.1 Soil

In general, applicable or relevant and appropriate requirements (ARARs) are not available for specific contaminants in soil. As a result, base-specific background concentrations have been compiled from a number of locations throughout MCB, Camp Lejeune to evaluate reference levels of inorganic analytes in the surface and subsurface soil.

Typical background concentration values for inorganic analytes in soils at MCB, Camp Lejeune are presented in Appendix P. These ranges are based on analytical results of background samples collected in areas not known to have been impacted by operations or disposal activities adjacent to Sites 1, 2, 6, 7, 16, 28, 30, 35, 54, 41, 43, 44, 54, 69, 74, 78, 80, and 86 (refer to Figure 1-2 for site locations throughout MCB, Camp Lejeune). Subsequent discussions of the analytical results from samples collected during the soil investigation only consider those inorganic analytes with concentrations exceeding twice the average base-specific background concentration, as recommended by USEPA Region IV.

In general, background soil samples have been collected outside the known boundaries of those sites listed above in areas with similar soil types. According to the Soil Conservation Service (SCS) Soil Survey, the greatest portion of MCB, Camp Lejeune is underlain by a number of similar soil units. Soils found on this portion of the coastal plain are moderately to strongly acidic in nature and are classified under the USCS as SM, SM-SP (i.e., fine sand or loamy fine sand). Section 3.2.2 and Figure 3-1 provide the locations of background soil borings completed at Site 54 during this investigation.

4.2.2.2 Groundwater

Chemical-specific ARARs are available for evaluation of analytical results from groundwater samples. In the subsequent sections which address the analytical results of samples collected during the groundwater investigation, only those inorganic parameters with concentrations exceeding applicable state or Federal regulations will be discussed.

Groundwater samples were analyzed for total inorganic parameters. In addition, a limited number of selected groundwater samples were submitted for dissolved (i.e., "filtered") inorganic analyses. Concentrations of dissolved inorganics were found to be generally lower than total inorganic

concentrations, particularly for metals such as chromium, iron, lead, and manganese. A 0.45-micron filter was used in the field to remove small particles of silt and clay that would otherwise be dissolved during sample preservation, resulting in higher concentrations of inorganic analytes. The total metal analyses from unfiltered samples is considered to reflect the concentrations of inorganics in the natural lithology and inorganic analytes dissolved in the groundwater.

Higher concentrations of certain metals in unfiltered groundwater samples collected at MCB, Camp Lejeune are not considered atypical based on experience gained during other studies. The difference between the two analytical results (i.e., total and filtered) is important in terms of understanding and separating naturally-occurring elements (e.g., lead) from contamination by site operations (e.g., lead in gasoline). An evaluation report which pertains to naturally occurring metals in groundwater at MCB, Camp Lejeune is provided in Appendix P.

USEPA Region IV requires that unfiltered inorganic concentrations be used in evaluating ARARs and risk to human health and the environment. In the subsequent sections, which discuss the groundwater sample analytical results, both total and dissolved inorganics (which exceed applicable state or Federal limits) will be presented and discussed for comparison purposes.

Groundwater in the MCB, Camp Lejeune area is naturally rich in iron and manganese. Iron and manganese concentrations, both for total and filtered samples, in groundwater at MCB, Camp Lejeune often exceed the North Carolina Water Quality Standards (NCWQS) of 300 and 50 µg/L. Elevated levels of iron and manganese, at concentrations above the NCWQS, were reported in samples collected from a number of base potable water supply wells which are installed at depths greater than 162 feet below ground surface (Greenhorne and O'Mara, 1992). Iron and manganese concentrations from several wells at Site 54 exceeded the NCWQS but fell within the range of concentrations for samples collected elsewhere at MCB, Camp Lejeune. There is no record of any historical use of iron or manganese at Site 54. In light of this, it is assumed that iron and manganese are naturally-occurring inorganic analytes in groundwater, and their presence is not attributable to site operations.

4.3 Analytical Results

This section presents the results of the soil and groundwater investigations performed at Site 54. A summary of site contamination, by media, is provided in Table 4-2.

4.3.1 Soil Investigation

Unique sample notations were employed to identify soil sampling locations and sample depths at Site 54. Samples designated by "DD" were collected from specific portions of the site (as described in Section 3.0). Samples designated with the prefix "GW" were collected from monitoring well pilot test borings. The following suffix designations refer to the depth at which a sample was obtained:

- 00 - ground surface to 12 inches bgs
- 01 - 1 to 3 feet bgs
- 02 - 3 to 5 feet bgs
- 03 - 5 to 7 feet bgs
- 04 - 7 to 9 feet bgs
- 05 - 9 to 11 feet bgs

Surface soil positive detection summaries for organic compounds and inorganic analytes are presented in Tables 4-3 and 4-4. A positive detection summary of organic compounds in subsurface soils is presented in Table 4-5; a summary of inorganic analytes is provided in Table 4-6. Each soil sample collected at Site 54 was analyzed for TCL volatile and TCL semivolative organics using CLP protocols and Level IV data quality (refer to Section 3.0). Soil samples obtained from monitoring well test borings were also analyzed for TCL volatile and TCL semivolative organics. A limited number of surface and subsurface soil samples were also submitted for PCB and TAL metal analyses. In addition, soil samples collected at Site 54 were submitted for TPH analysis (refer to Appendix L).

4.3.1.1 Surface Soil

A total of 11 surface soil samples were collected at Site 54; each sample was analyzed for TCL volatile and TCL semivolatile organic compounds. In addition, 4 of the 11 samples were also submitted for PCB and TAL metal analyses. As indicated in Table 4-2, volatile and PCB organic compounds were not detected in surface soils at Site 54. In addition, results from TPH analyses indicate that no total petroleum hydrocarbons were detected among surface soil samples.

A total of six SVOCs were detected in five of the surface soil samples submitted for laboratory analysis from Site 54. In general, positive SVOC detections were observed in soil samples collected from the southern portion of the study area. Three of the six semivolatile contaminants detected were polynuclear aromatic hydrocarbons (PAHs). Semivolatile concentrations ranged from 50 µg/kg to 320 µg/kg of butylbenzylphthalate. As presented in Table 4-3, semivolatile compounds were detected with the most frequency in samples obtained from the drainage ditch, which acts as a conduit for surface water runoff from the burn pit area. Sampling locations DD-SB01 and DD-SB03 had four and three positive semivolatile detections, respectively. Five of the six maximum semivolatile detections were observed in samples obtained from the drainage ditch.

Fifteen of 23 TAL inorganics were detected among the 4 surface soil samples submitted for laboratory analysis from Site 54 (antimony, beryllium, cadmium, mercury, nickel, selenium, silver, and thallium were not detected). Table 4-2 provides a summary of the priority pollutant inorganic analytes found within soil samples at Site 54. Priority pollutant metals are a subset of TAL metals which include antimony, arsenic, beryllium, cadmium, chromium, copper, lead, mercury, nickel, selenium, silver, thallium, and zinc. As provided in Table 4-2, both chromium and zinc were detected at concentrations exceeding twice their average base-specific background levels in more than two of the four surface soil samples (refer to Appendix P for base-specific inorganic background concentrations). Chromium was detected at concentrations ranging from 5.7 to 9.1 mg/kg; three of the four positive chromium detections slightly exceeded twice the average base-specific background concentration of 6.7 mg/kg. Two of the four zinc detections exceeded twice the average background concentration of 13.9 mg/kg. Zinc was detected in each of the four surface soil samples at concentrations ranging from 8.3 to 16.7 mg/kg.

4.3.1.2 Subsurface Soil

A total of 19 subsurface (i.e., greater than one-foot bgs) soil samples from Site 54 were submitted for laboratory analysis; each sample was analyzed for TCL volatile and semivolatile organics; eight samples were also submitted for TAL metal and PCB analyses. Analytical results from these samples indicate the presence of organic compounds and inorganic analytes. However, TPH and PCB compounds were not detected in any of the subsurface soil samples.

The volatile compounds acetone and total xylenes were detected in the samples submitted for analysis from Site 54 (refer to Table 4-2). As provided in Table 4-2, acetone was detected once among the 19 subsurface samples at a concentration of 1,200 µg/kg. Total xylenes were detected at concentrations of 300 and 12 µg/kg in adjacent soil sampling locations, SB08 and SB09, respectively. The three subsurface VOC detections were observed in samples from the southern and southwestern portions of the study area, near the site boundary.

Seven semivolatile compounds were detected among 3 of the 19 subsurface soil samples obtained at Site 54. Five of the seven semivolatile compounds were detected in a soil sample obtained from location DD-SB05. Five of the seven SVOCs detected were PAH compounds. Semivolatile concentrations ranged from 43 µg/kg of pyrene to 1,700 µg/kg of 2-methylnaphthalene in sample DD-SB05. As provided in Table 4-2, six of the seven semivolatile compounds were detected at their respective maximum concentrations within a subsurface soil sample from boring DD-SB05.

Sixteen of 23 TAL inorganics were detected in subsurface soils at Site 54 (antimony, beryllium, cadmium, mercury, selenium, silver, and thallium were not detected). As presented in Table 4-2, lead and nickel were each detected at concentrations exceeding twice their average base-specific background levels more than two times among the eight subsurface soil samples submitted for TAL metal analyses. Lead was detected at concentrations ranging from 1.4 to 11.5 mg/kg. Three of the eight positive lead detections slightly exceeded twice the average base background concentration of 8.3 mg/kg. Two of the six positive nickel detections also slightly exceeded twice the average background concentration of 3.7 mg/kg. Nickel was detected at concentrations ranging from 1.1 to 6.2 mg/kg.

4.3.1.3 Summary

SVOCs were identified in both surface and subsurface soil samples from the southern and southwestern portions of the study area. The majority of SVOCs detected in soil samples were PAH compounds. As provided in Table 4-2, only one SVOC (2-methylnaphthalene) and one VOC (acetone) were detected at concentrations greater than 1,000 µg/kg.

Inorganic analytes were detected in both surface and subsurface soil samples at concentrations above twice the average applicable base-specific background levels. The metals chromium, lead, nickel, and zinc were observed at maximum concentrations within 5 mg/kg of twice their average base-specific background levels.

4.3.2 **Groundwater Investigation**

The groundwater investigation at Site 54 included the collection of 17 groundwater samples obtained from 7 temporary and 10 shallow monitoring wells. Each of the 17 groundwater samples were analyzed for TCL volatile and semivolatile organics using CLP protocols and Level IV data quality. TAL metal and PCB analyses were requested for 13 of the 17 temporary and shallow monitoring wells installed at Site 54. One of the 17 groundwater samples was also submitted for pesticide analysis. In addition, dissolved TAL metal analyses were performed on two of the groundwater samples obtained from the study area. (Dissolved or filtered TAL inorganic results are presented in this report for comparison purposes only. These results were not used to evaluate site-related risks or to determine compliance with groundwater standards.)

Groundwater samples were collected from three existing shallow wells (54-GW01, 54-GW02, and 54-GW03), seven newly installed shallow wells (54-GW04 through 54-GW10), and seven temporary wells (54-TW01 through 54-TW07) at Site 54. Based upon the analytical results generated during the initial phase of groundwater sampling activities, three of the shallow and four of the temporary monitoring wells mentioned above were added to the investigation. Groundwater conditions within the upper and lower portions of the surficial aquifer were evaluated through collection and analysis of samples from both shallow Type II and shallow Type III monitoring wells (refer to Section 3.0 and Appendix B for well construction details).

A total of 17 shallow groundwater samples from Site 54 were submitted for laboratory analysis. As indicated in Table 4-7, seven volatile organic compounds were detected among samples obtained from seven of the monitoring wells. Positive VOC detections were limited to portions of the study area immediately adjacent to the burn pit or UST and extending southwest of the burn pit. The volatile compounds 1,2-dichloroethene, benzene, toluene, ethylbenzene, and total xylenes were detected in at least two of the 17 samples obtained during investigation activities at Site 54. As provided in Table 4-2, maximum concentrations of 1,2-dichloroethene, benzene, toluene, ethylbenzene, and total xylenes were 23, 40, 83, 26, and 126 µg/L, respectively. Carbon disulfide and trichloroethene were each detected only once among the sample set at concentrations of 4 and 1 µg/L. Benzene was detected in 6 of the 17 groundwater samples and at concentrations in excess of the NCWQS of 1 µg/L. None of the other volatile compounds were detected at concentrations in excess of applicable screening standards.

A total of eight semivolatile compounds were detected among ten of the groundwater samples submitted for analysis from Site 54. The maximum SVOC concentration, 240 µg/L of naphthalene, was detected in temporary monitoring well 54-TW03 located immediately adjacent to the burn pit. As provided in Table 4-2, phenol, nitrobenzene, 2,4-dimethylphenol, and anthracene were each detected once among groundwater samples at concentrations of less than 3 µg/L. Di-n-butylphthalate was detected in two wells located southwest of the burn pit at concentrations of 1 and 2 µg/L. Naphthalene, 2-methylnaphthalene, and diethylphthalate were detected in 7, 6, and 5 of the 17 groundwater samples, respectively. Five of the naphthalene detections exceeded the NCWQS level of 21 µg/L. None of the other semivolatile compounds were detected at concentrations in excess of applicable screening standards. In general, semivolatile detections were limited to the same portions of the site as volatile compounds.

Total metals were detected in each of the temporary and shallow monitoring wells at Site 54. Dissolved metals were also detected in both of the groundwater samples submitted for filtered analysis. Complete positive detection summaries for total and dissolved metals are provided in Tables 4-8 and 4-9. Fourteen of the 23 TAL total metals were detected within at least one groundwater sample at Site 54 (antimony, beryllium, cadmium, copper, mercury, selenium, silver, thallium, and vanadium were not detected). Only 11 of 23 TAL metals were detected within at least one of the groundwater samples submitted for dissolved analyses (in addition to the total metals that were not detected; aluminum, arsenic, and chromium were not detected in the samples submitted for dissolved analysis). Iron and manganese were detected with the greatest frequency among groundwater samples and at concentrations in excess of NCWQS levels, as provided in Table 4-2. Iron exceeded the NCWQS of 300 µg/L in 9 of the 13 groundwater samples obtained from Site 54, with a maximum concentration of 74,100 µg/L. Manganese was detected at concentrations exceeding the NCWQS of 50 µg/L in groundwater samples obtained from 9 of the 13 monitoring wells, with a maximum concentration of 1,280 µg/L. Lead was detected once among the sample set,

in upgradient well 54-GW02, at a concentration of 39.7 µg/L which exceeded the NCWQS of 15 µg/L.

4.3.2.3 Summary

Inorganics were the most prevalent and widely distributed potential contaminants in groundwater at Site 54. Iron and manganese were the most prevalent inorganic analytes, detected at concentrations that exceeded state standards within nine groundwater samples each. Lead was detected in an upgradient well at a concentration which exceeded the state standard by nearly 25 µg/L. No other inorganics were detected above applicable screening standards. Table 4-2 presents a summary of inorganic analytes in excess of applicable water quality standards.

Positive detections of organic compounds were limited to portions of the study area immediately adjacent to the burn pit or UST and extending southwest of the burn pit. The presence of volatile and semivolatile compounds in samples obtained from this portion of the study area is consistent with current site operations. Six positive detections of benzene and five positive detections of naphthalene exceeded applicable NCWQS values of 1 and 21 µg/L.

4.4 Extent of Contamination

This section addresses the extent of contamination within soil and groundwater at OU No. 6, Site 54.

4.4.1 Extent of Soil Contamination

Positive detections of organic compounds in surface and subsurface soil samples collected at Site 54 are depicted on Figures 4-1 and 4-2. The sections which follow detail the presence of both organic compounds and inorganic analytes in soil samples from Site 54. As addressed in Section 4.3.1, PCB compounds and petroleum hydrocarbons were not detected in any of the soil samples submitted for analyses from Site 54. As a result of those analyses, PCB and TPH contamination at Site 54 will not be addressed.

4.4.1.1 Volatiles

Volatile compounds were detected in three subsurface soil samples from Site 54. The positive detections were identified in samples from the southern and southwestern portions of the study area, greater than 250 feet away from the burn pit. None of the surface soil samples had detectable concentrations of VOCs. Total xylenes were detected in two subsurface samples collected from an area identified during the RI scoping site visit by a lack of vegetative cover. As depicted on Figure 4-2, both detections lie approximately 250 feet southwest of the burn pit. The limited occurrence and low concentrations of total xylene, 12 and 300 µg/kg, suggests that its presence is most likely the result of a spill rather than long term disposal operations.

Acetone was detected in a sample obtained beyond the southern boundary of the study area, approximately 400 feet south of the burn pit. Five semivolatile compounds were also detected within the sample obtained from location DD-SB05. With the exception of acetone, similar detections of semivolatile compounds were found in samples obtained from the drainage ditch which acts as a conduit for surface water runoff from the burn pit area. The presence of acetone and other semivolatile compounds at this location is most likely the result of previous and ongoing burning exercises.

4.4.1.2 Semivolatiles

The presence and dispersion of SVOCs in soil, particularly PAH compounds, is most likely the result of burning operations at Site 54. Concentrations of semivolatile compounds in soil samples are consistent with the use of the site. Semivolatile compounds were identified in both surface and subsurface soil samples in the direction of surface water runoff; primarily to the south of the burn pit. Positive SVOC detections were limited to soil samples obtained from the first five feet below ground surface. As depicted on Figures 4-1 and 4-2, concentrations of SVOCs were generally less than 500 µg/kg. The horizontal distribution and low concentrations of semivolatile compounds suggests that contaminants have migrated via surface water drainage toward the southern boundary of the site. Naphthalene and di-n-octylphthalate detections were also observed in an area 250 feet southwest of the burn pit; in conjunction with positive VOC detections.

4.4.1.3 Metals

As addressed in Section 4.3.1 and provided in Table 4-2, a limited number of samples submitted for analysis had TAL metal concentrations greater than twice the average base-specific background concentration. Inorganic analytes were detected in both surface and subsurface soil samples throughout the study area. Chromium, lead, nickel, and zinc were detected fewer than four times at concentrations exceeding twice their average background levels by less than 5 mg/kg. The maximum concentrations of metals in samples obtained from the study area appear to coincide with samples identified as having semivolatile contaminants, namely from the drainage ditch which leads south from the burn pit. Although observed concentrations of inorganics at Site 54 are not indicative of disposal operations or process by-products, elevated detections of metals in samples obtained from the drainage ditch suggests that their presence may be related to site operations.

4.4.2 **Extent of Groundwater Contamination**

Positive detections of organic compounds in groundwater samples collected at Site 54 are depicted on Figure 4-3. Figure 4-4 presents TAL metal sampling results in excess of either Federal MCL or NCWQS levels. As addressed in Section 4.3.2, pesticide and PCB compounds were not detected in any of the groundwater samples submitted for analysis from Site 54. As a result of those analyses, the extent of pesticide and PCB contamination in groundwater will not be addressed.

4.4.2.1 Volatiles

Positive detections of volatile compounds were limited to portions of the study area immediately adjacent to the burn pit or UST (identified on Figure 4-1 as "Concrete Slab") and extending southwest of the burn pit. The lack of positive detections in samples obtained from portions of the site to the north, south, and southeast of the burn pit suggests that the extent of VOC contamination in groundwater is limited to the observed locations. The highest concentration of a single VOC, total xylenes at 130 µg/L, was detected in a sample obtained from temporary well 54-TW03. The majority of higher volatile detections were observed in samples from temporary monitoring wells located immediately adjacent to either the burn pit or the on-site UST. The lack of positive VOC detections in wells which are hydraulically downgradient of the burn pit suggests that site contamination may have resulted from unintentional spillage or splashing of waste fuels during fire training exercises, rather than from faulty burn pit liner material. In addition, the on-site UST passed a fitness test in July 1994 and is scheduled to be replaced in 1996.

A semi-confining unit comprised of silt and clay underlies a majority of the burn pit area at Site 54 (refer to Section 2.0). As depicted on Figure 4-3, no organic compounds were detected in the sample obtained beneath this semi-confining unit from monitoring well 54-GW08. The absence of VOC detections in this lower portion of the surficial aquifer suggests that contaminants have not migrated beneath the semi-confining layer.

4.4.2.2 Semivolatiles

Semivolatile organic compounds were detected in 10 of the 17 groundwater samples submitted for laboratory analysis from Site 54. With the exception of an existing upgradient monitoring well, 54-GW02, each of the semivolatile detections were observed in samples obtained from portions of the study area immediately adjacent to the burn pit or UST and extending southwest of the burn pit. In general, both volatile and semivolatile organic compounds were detected in groundwater samples obtained from the same area within the study area. No SVOCs were detected in the sample obtained below the semi-confining layer which partially separates the upper and lower portions of the surficial aquifer at Site 54.

A total of seven semivolatile compounds were detected among samples obtained from five temporary and five permanent monitoring wells at Site 54 (see Figure 4-3). Five of the seven SVOCs were detected at concentrations of less than 5 µg/L. The maximum semivolatile concentration was that of naphthalene at 240 µg/L. In general, positive detections of both volatile and semivolatile compounds were observed in the same or adjacent monitoring wells during the groundwater investigation.

4.4.2.3 Metals

Inorganic analytes were detected in each of the 17 groundwater samples submitted for analysis from Site 54. Iron, lead, and manganese were the only TAL total metals detected, among samples obtained from the ten permanent and seven temporary monitoring wells, at levels in excess of either Federal MCL or NCWQS (see Figure 4-4). Positive detections of both iron and manganese were distributed throughout the site, indicative of natural site conditions rather than disposal activities. Lead was detected within a sample obtained from an upgradient existing well at a concentration which exceeded the NCWQS of 15 µg/L by less than 25 µg/L.

Elevated total metal observations have been recorded at other MCB, Camp Lejeune sites and have been attributed as the likely consequence of loose surficial soils. During sampling, a low flow purge method was utilized to minimize the presence suspended solids or colloids in samples that are associated with the surficial soils. The DON is currently evaluating the presence and distribution of total and dissolved metals in groundwater throughout the facility. The draft report entitled "Evaluation of Metals in Groundwater at MCB, Camp Lejeune, North Carolina," (provided as Appendix P) addresses the pervasiveness of total metals in groundwater and identifies a number of potential causes. Preliminary conclusions of the study support the opinion that total metal concentrations in groundwater are due more to geologic conditions (i.e., naturally occurring concentrations and unconsolidated soils) and sample acquisition methods than to mobile metal concentrations in the surficial aquifer.

4.5 References

Baker Environmental, Inc. December 1994. Remedial Investigation/Feasibility Study Work Plan for Operable Unit No. 6 (Sites 54, 43, 44, 54, and 86), Marine Corps Base Camp Lejeune, North Carolina. Final. Prepared for the Department of the Navy, Naval Facilities Engineering Command, Atlantic Division, Norfolk, Virginia.

Greenhorne & O'Mara, Inc. 1992. Wellhead Monitoring Study Marine Corps Base, Camp Lejeune, North Carolina. Preliminary Draft. Prepared for Department of the Navy, Naval Facilities Engineering Command, Atlantic Division, Norfolk, Virginia.

United States Environmental Protection Agency (USEPA). 1988. Laboratory Guidelines for Evaluating Inorganics Analysis. Prepared for: Hazardous Site Evaluation Division, U.S. Environmental Protection Agency. Compiled by: Ruth Bleyler. Prepared by: The USEPA Data Review Work Group.

United States Environmental Protection Agency (USEPA). 1989. Risk Assessment Guidance for Superfund Volume II. Environmental Evaluation Manual Interim Final. Office of Solid Waste and Emergency Response. Washington, D.C. EPA/540/1-89-001. May 1989.

United States Environmental Protection Agency (USEPA). 1991. National Functional Guidelines for Organic Data Review. Draft. USEPA Contract Laboratory Program.

SECTION 4.0 TABLES

TABLE 4-1

**SUMMARY OF REJECTED DATA
SITE 54, CRASH CREW FIRE TRAINING BURN PIT
REMEDIAL INVESTIGATION, CTO-0303
MCAS, NEW RIVER, NORTH CAROLINA**

Media	Sample Number	Chemical/Category	Comment
Soils	54-ES12RE	VOCs	1
	54-ES15		
	54-SB09-00RE		
	54-SB04-00		
	54-ES12	SVOCs	2
	54-ES12DL	SVOCs	3
	54-DD-SB05-01	SVOCs	1
	54-SB08-00	SVOCs	4
	54-SB03-01RE	SVOCs	5
Groundwater	54-TW02-01	SVOCs	2
	54-TW05-01		
	54-TW02-01DL	SVOCs	3
	54-TW05-01DL		

Comments:

1. Reject all results for the re-analyzed sample(s) in favor of the original sample(s) due to noncompliant internal standard areas.
2. Reject all TICs flagged with the laboratory qualifier "B" due to method blank contamination.
3. Reject all results except for the D-flagged results that correspond with E-flagged results in the original sample.
4. Reject results due to noncompliant surrogate recoveries and/or internal standard areas.
5. Reject results due to exceeding the extraction holding time.

TABLE 4-2

SUMMARY OF SITE CONTAMINATION
 SITE 54, CRASH CREW FIRE TRAINING BURN PIT
 REMEDIAL INVESTIGATION, CTO-0303
 MCAS, NEW RIVER, NORTH CAROLINA

Media	Fraction	Detected Contaminants	Comparison Criteria		Site Contamination				
			Standard	Base Background	Min.	Max.	Max. Location	Detection Frequency	Distribution
Surface Soil	Volatiles	ND	NA	NA				0/11	
	Semivolatiles	n-Nitrosodiphenylamine	NA	NA	160	160	DD-SB01	1/11	south, drainage ditch
		Phenanthrene (PAH)	NA	NA	98	120	DD-SB03	2/11	south, drainage ditch
		Fluoranthene (PAH)	NA	NA	62	67	DD-SB01	2/11	south, drainage ditch
		Pyrene (PAH)	NA	NA	99	150	DD-SB01	2/11	south, drainage ditch
		Butylbenzylphthalate	NA	NA	50	320	DD-SB04	2/11	south, drainage ditch
		Di-n-octylphthalate	NA	NA	150	150	SB08	1/11	southwest of burn pit
	PCBs	ND	NA	NA				0/4	
	Metals (1)	Chromium	NA	6.7	5.7	9.1	DD-SB04	4/4	3 exceed BB, drainage ditch
		Zinc	NA	13.9	8.3	16.7	DD-SB04	4/4	2 exceed BB, drainage ditch
Subsurface Soil	Volatiles	Acetone	NA	NA	1,200	1,200	DD-SB05	1/19	1 exceeds blank, drainage ditch
		Xylene (total)	NA	NA	12	300	SB08	2/19	southwest of burn pit
	Semivolatiles	Naphthalene (PAH)	NA	NA	760	760	SB08	1/19	southwest of burn pit
		2-Methylnaphthalene	NA	NA	1,700	1,700	DD-SB05	1/19	south, drainage ditch
		Acenaphthene (PAH)	NA	NA	94	94	DD-SB05	1/19	south, drainage ditch
		Fluorene (PAH)	NA	NA	420	420	DD-SB05	1/19	south, drainage ditch
		Phenanthrene (PAH)	NA	NA	160	160	DD-SB05	1/19	south, drainage ditch
		Pyrene (PAH)	NA	NA	43	43	DD-SB05	1/19	south, drainage ditch
		Butylbenzylphthalate	NA	NA	56	56	DD-SB03	1/19	south, drainage ditch
	PCBs	ND	NA	NA				0/8	
	Metals (1)	Lead	NA	8.3	1.4	11.5	DD-SB03	8/8	3 exceed BB, scattered
Nickel		NA	3.7	1.1	6.2	DD-SB02	6/8	2 exceed BB, south and southwest	

TABLE 4-2 (Continued)

SUMMARY OF SITE CONTAMINATION
 SITE 54, CRASH CREW FIRE TRAINING BURN PIT
 REMEDIAL INVESTIGATION, CTO-0303
 MCAS, NEW RIVER, NORTH CAROLINA

Media	Fraction	Detected Contaminants	Comparison Criteria		Site Contamination				
			Standard	Base Background	Min.	Max.	Max. Location	Detection Frequency	Distribution
Groundwater	Volatiles	Carbon Disulfide	NCWQS - 700	NA	4	4	54-GW10	1/17	does not exceed standard, east
		1,2-Dichloroethene (total)	MCL - 70	NA	5	23	54-TW03	3/17	none exceed standard, southeast
		Trichloroethene	MCL - 5	NA	1	1	54-TW03	1/17	does not exceed standard, southeast
		Benzene	NCWQS - 1	NA	5	40	54-TW04	6/17	6 exceed standard, south and east
		Toluene	NCWQS - 1,000	NA	22	83	54-TW03	2/17	do not exceed standard, southeast
		Ethylbenzene	NCWQS - 29	NA	6	26	54-TW04	3/17	none exceed standard, southeast
		Xylene (total)	NCWQS - 530	NA	27	130	54-TW03	3/17	none exceed standard, southeast
	Semivolatiles	Phenol	NCWQS - 300	NA	1	1	54-TW04	1/17	does not exceed standard, east
		Nitrobenzene	NA	NA	2	2	54-TW04	1/17	east of burn pit, adjacent to UST
		2,4-Dimethylphenol	NA	NA	3	3	54-TW06	1/17	east of burn pit, adjacent to UST
		Naphthalene (PAH)	NCWQS - 21	NA	1	240	54-TW03	7/17	5 exceed standard, south and east
		2-Methylnaphthalene	NA	NA	1	160	54-TW03	6/17	south and east, 3 of 6 at UST
		Diethylphthalate	NCWQS - 5,000	NA	1	37	54-TW03	5/17	none exceed standard, southeast
		Anthracene (PAH)	NCWQS - 2,100	NA	1	1	54-TW05	1/17	does not exceed standard, UST
	Di-n-butylphthalate	NCWQS - 700	NA	1	2	54-GW09	2/17	do not exceed standard, scattered	

TABLE 4-2 (Continued)

**SUMMARY OF SITE CONTAMINATION
SITE 54, CRASH CREW FIRE TRAINING BURN PIT
REMEDIAL INVESTIGATION, CTO-0303
MCAS, NEW RIVER, NORTH CAROLINA**

Media	Fraction	Detected Contaminants	Comparison Criteria		Site Contamination				
			Standard	Base Background	Min.	Max.	Max. Location	Detection Frequency	Distribution
Groundwater (Continued)	Pesticides	ND	MCL/NCWQS	NA				0/1	
	PCBs	ND	MCL/NCWQS	NA				0/13	
	Total Metals	Iron	NCWQS - 300	NA	193	74,100	54-TW03	12/13	9 exceed standard, scattered
		Lead	NCWQS - 15	NA	1.9	39.7	54-GW02	5/13	1 exceeds standard, upgradient
		Manganese	NCWQS - 50	NA	25.2	1,280	54-GW03	13/13	9 exceed standard, scattered

Notes:

- Concentrations are presented in $\mu\text{g/L}$ for liquid and $\mu\text{g/Kg}$ for solids (ppb), metal concentrations for soils and sediments are presented in mg/Kg (ppm).

(1) Metals in both surface and subsurface soils were compared to twice the average base background positive concentrations for priority pollutant metals only (i.e., antimony, arsenic, beryllium, cadmium, chromium, copper, lead, mercury, nickel, selenium, silver, thallium, zinc).

BB - Base background, value equals two times average value for soil (refer to Appendix Q)

NA - Not applicable

NCWQS - North Carolina Water Quality Standard

ND - Not detected

MCL - Federal Maximum Contaminant Level

PAH - Polynuclear aromatic hydrocarbon

TABLE 4-3
SURFACE SOIL - POSITIVE DETECTION SUMMARY
SITE 54, CRASH CREW FIRE TRAINING BURN PIT
REMEDIAL INVESTIGATION, CTO-0303
MCAS, NEW RIVER, NORTH CAROLINA
TCL ORGANICS

LOCATION	54-DD-SB01-00	54-DD-SB02-00	54-DD-SB03-00	54-DD-SB04-00	54-DD-SB05-00	54-SB01-00
DATE SAMPLED	03/10/95	03/10/95	03/10/95	03/10/95	04/11/95	03/11/95
DEPTH	0-12"	0-12"	0-12"	0-12"	0-12"	0-12"
SEMIVOLATILES (ug/kg)						
N-NITROSODIPHENYLAMINE (1)	160 J	410 U	380 U	400 U	420 U	360 U
PHENANTHRENE	98 J	410 U	120 J	400 U	420 U	360 U
FLUORANTHENE	67 J	410 U	62 J	400 U	420 U	360 U
PYRENE	150 J	410 U	99 J	400 U	420 U	360 U
BUTYLBENZYLPHTHALATE	400 U	410 U	380 U	320 J	400 U	360 U
BIS(2-ETHYLHEXYL)PHTHALATE	820	73 J	98 J	160 J	59 J	360 U
DI-N-OCTYL PHTHALATE	400 UJ	410 U	380 U	400 U	420 U	360 U

UG/KG - microgram per kilogram
 J - value is estimated
 U - not detected
 UJ - not detected, value is estimated

TABLE 4-3
 SURFACE SOIL - POSITIVE DETECTION SUMMARY
 SITE 54, CRASH CREW FIRE TRAINING BURN PIT
 REMEDIAL INVESTIGATION, CTO-0303
 MCAS, NEW RIVER, NORTH CAROLINA
 TCL ORGANICS

LOCATION	54-SB04-00	54-SB06-00	54-SB07-00	54-SB08-00	54-SB09-00
DATE SAMPLED	03/11/95	03/12/95	03/12/95	03/11/95	03/11/95
DEPTH	0-12"	0-12"	0-12"	0-12"	0-12"
SEMIVOLATILES (ug/kg)					
N-NITROSODIPHENYLAMINE (1)	380 U	350 U	370 U	400 U	410 U
PHENANTHRENE	380 U	350 U	370 U	400 U	410 U
FLUORANTHENE	380 U	350 U	370 U	400 U	410 U
PYRENE	380 U	350 U	370 U	400 U	410 U
BUTYLBENZYLPHTHALATE	380 U	350 U	50 J	400 U	410 U
BIS(2-ETHYLHEXYL)PHTHALATE	380 U	350 U	370 U	190 J	410 U
DI-N-OCTYL PHTHALATE	380 U	350 U	370 U	150 J	410 U

UG/KG - microgram per kilogram
 J - value is estimated
 U - not detected
 UJ - not detected, value is estimated

TABLE 4-4
 SURFACE SOIL - POSITIVE DETECTION SUMMARY
 SITE 54, CRASH CREW FIRE TRAINING BURN PIT
 REMEDIAL INVESTIGATION, CTO-0303
 MCAS, NEW RIVER, NORTH CAROLINA
 TAL METALS

LOCATION	54-DD-SB01-00	54-DD-SB02-00	54-DD-SB03-00	54-DD-SB04-00
DATE SAMPLED	03/10/95	03/10/95	03/10/95	03/10/95
DEPTH	0-12"	0-12"	0-12"	0-12"
ANALYTES (mg/kg)				
ALUMINUM, TOTAL	5130	5950	4680	6930
ARSENIC, TOTAL	0.65 J	0.79 J	0.3 J	0.63 J
BARIUM, TOTAL	26.9	17.5	12.3	26.3
CALCIUM, TOTAL	37700	142000	37800	60900
CHROMIUM, TOTAL	7.2	9.1	5.7	9.1
COBALT, TOTAL	0.7 U	0.69 U	0.61 U	0.71
COPPER, TOTAL	7.2	3.3	2.8	4.1
IRON, TOTAL	2630	3130	2150	3640
LEAD, TOTAL	9.7	23	19.9	14.6
MAGNESIUM, TOTAL	633	2030	654	1030
MANGANESE, TOTAL	14.5	23.9	10.5	18.3
POTASSIUM, TOTAL	367	319	140 U	273
SODIUM, TOTAL	93.6	179	101	107
VANADIUM, TOTAL	9.1	10.1	7	11.8
ZINC, TOTAL	14.9	12.6	8.3	16.7

MG/KG - milligram per kilogram

J - value is estimated

U - not detected

TABLE 4-5
SUBSURFACE SOIL - POSITIVE DETECTION SUMMARY
SITE 54, CRASH CREW FIRE TRAINING BURN PIT
REMEDIAL INVESTIGATION, CTO-0303
MCAS, NEW RIVER, NORTH CAROLINA
TCL ORGANICS

LOCATION	54-DD-SB01-02	54-DD-SB02-02	54-DD-SB03-01	54-DD-SB04-01	54-DD-SB05-01	54-SB01-04
DATE SAMPLED	03/10/95	03/10/95	03/10/95	03/10/95	04/11/95	03/11/95
DEPTH	3-5'	3-5'	1-3'	1-3'	1-3'	7-9'
VOLATILES (ug/kg)						
ACETONE	12 U	12 U	12 U	13 U	1200 J	17 U
XYLENE (TOTAL)	12 U	12 U	12 U	13 UJ	120 U	12 U
SEMIVOLATILES (ug/kg)						
NAPHTHALENE	390 U	380 U	390 U	420 U	390 U	380 U
2-METHYLNAPHTHALENE	390 U	380 U	390 U	420 U	1700	380 U
ACENAPHTHENE	390 U	380 U	390 U	420 U	94 J	380 U
FLUORENE	390 U	380 U	390 U	420 U	420	380 U
PHENANTHRENE	390 U	380 U	390 U	420 U	160 J	380 U
PYRENE	390 U	380 U	390 U	420 U	43 J	380 U
BUTYLBENZYLPHTHALATE	390 U	380 U	56 J	420 U	390 U	380 U
BIS(2-ETHYLHEXYL)PHTHALATE	390 U	380 U	390 U	420 U	49 J	380 U

UG/KG - microgram per kilogram
J - value is estimated
U - not detected
UJ - not detected, value is estimated

TABLE 4-5
 SUBSURFACE SOIL - POSITIVE DETECTION SUMMARY
 SITE 54, CRASH CREW FIRE TRAINING BURN PIT
 REMEDIAL INVESTIGATION, CTO-0303
 MCAS, NEW RIVER, NORTH CAROLINA
 TCL ORGANICS

LOCATION	54-SB02-01	54-SB02-04	54-SB03-01	54-SB03-04	54-SB04-04	54-SB05-01
DATE SAMPLED	03/11/95	03/11/95	03/11/95	03/11/95	03/11/95	03/11/95
DEPTH	1-3'	7-9'	1-3'	7-9'	7-9'	1-3'
VOLATILES (ug/kg)						
ACETONE	11 UJ	23 U	16 U	22 U	13 U	11 U
XYLENE (TOTAL)	11 U	12 U	11 U	12 U	12 U	11 U
SEMIVOLATILES (ug/kg)						
NAPHTHALENE	370 U	390 U	370 U	400 U	380 U	360 U
2-METHYLNAPHTHALENE	370 U	390 U	370 U	400 U	380 U	360 U
ACENAPHTHENE	370 U	390 U	370 U	400 U	380 U	360 U
FLUORENE	370 U	390 U	370 U	400 U	380 U	360 U
PHENANTHRENE	370 U	390 U	370 U	400 U	380 U	360 U
PYRENE	370 U	390 U	370 U	400 U	380 U	360 U
BUTYLBENZYLPHTHALATE	370 U	390 U	370 U	400 U	380 U	360 U
BIS(2-ETHYLHEXYL)PHTHALATE	370 U	390 U	370 U	400 U	380 U	360 U

UG/KG - microgram per kilogram
 J - value is estimated
 U - not detected
 UJ - not detected, value is estimated

TABLE 4-5
 SUBSURFACE SOIL - POSITIVE DETECTION SUMMARY
 SITE 54, CRASH CREW FIRE TRAINING BURN PIT
 REMEDIAL INVESTIGATION, CTO-0303
 MCAS, NEW RIVER, NORTH CAROLINA
 TCL ORGANICS

LOCATION	54-SB05-04	54-SB06-02	54-SB06-05	54-SB07-05	54-SB08-01	54-SB08-04
DATE SAMPLED	03/11/95	03/12/95	03/12/95	03/12/95	03/11/95	03/11/95
DEPTH	7-9'	3-5'	9-11'	9-11'	1-3'	7-9'
VOLATILES (ug/kg)						
ACETONE	15 U	16 U	34 U	20 U	120 U	14 U
XYLENE (TOTAL)	11 U	12 U	12 U	12 U	300	12 U
SEMIVOLATILES (ug/kg)						
NAPHTHALENE	340 U	380 U	400 U	400 U	760	380 U
2-METHYLNAPHTHALENE	340 U	380 U	400 U	400 U	390 U	380 U
ACENAPHTHENE	340 U	380 U	400 U	400 U	390 U	380 U
FLUORENE	340 U	380 U	400 U	400 U	390 U	380 U
PHENANTHRENE	340 U	380 U	400 U	400 U	390 U	380 U
PYRENE	340 U	380 U	400 U	400 U	390 U	380 U
BUTYLBENZYLPHTHALATE	340 U	380 U	400 U	400 U	390 U	380 U
BIS(2-ETHYLHEXYL)PHTHALATE	340 U	380 U	400 U	400 U	390 U	380 U

UG/KG - microgram per kilogram
 J - value is estimated
 U - not detected
 UJ - not detected, value is estimated

TABLE 4-5
 SUBSURFACE SOIL - POSITIVE DETECTION SUMMARY
 SITE 54, CRASH CREW FIRE TRAINING BURN PIT
 REMEDIAL INVESTIGATION, CTO-0303
 MCAS, NEW RIVER, NORTH CAROLINA
 TCL ORGANICS

LOCATION	54-SB09-03
DATE SAMPLED	03/11/95
DEPTH	5-7'
VOLATILES (ug/kg)	
ACETONE	40 U
XYLENE (TOTAL)	12
SEMIVOLATILES (ug/kg)	
NAPHTHALENE	380 U
2-METHYLNAPHTHALENE	380 U
ACENAPHTHENE	380 U
FLUORENE	380 U
PHENANTHRENE	380 U
PYRENE	380 U
BUTYLBENZYLPHTHALATE	380 U
BIS(2-ETHYLHEXYL)PHTHALATE	380 U

UG/KG - microgram per kilogram
 J - value is estimated
 U - not detected
 UJ - not detected, value is estimated

TABLE 4-6
 SUBSURFACE SOIL - POSITIVE DETECTION SUMMARY
 SITE 54, CRASH CREW FIRE TRAINING BURN PIT
 REMEDIAL INVESTIGATION, CTO-0303
 MCAS, NEW RIVER, NORTH CAROLINA
 TAL METALS

LOCATION	54-DD-SB01-02	54-DD-SB02-02	54-DD-SB03-01	54-DD-SB04-01	54-SB03-01	54-SB03-04
DATE SAMPLED	03/10/95	03/10/95	03/10/95	03/10/95	03/11/95	03/11/95
DEPTH	3-5'	3-5'	1-3'	1-3'	1-3'	7-9'
ANALYTES (mg/kg)						
ALUMINUM, TOTAL	1920	2350	2870	13400	6000	2680
ARSENIC, TOTAL	0.26 UJ	0.23 UJ	0.28 UJ	0.31 UJ	0.46 J	0.39 U
BARIUM, TOTAL	3	4.5	4.9	27.5	13.7	5.4
CALCIUM, TOTAL	60.9	74.9	2720	1100	5220	70.5
CHROMIUM, TOTAL	2.1 U	3.2	3.3	12	6	2.6
COBALT, TOTAL	0.64 U	0.6 U	0.66 U	1.2	0.51 U	0.48 U
COPPER, TOTAL	0.4 U	0.48	0.42 U	0.76	1.1	0.83 U
IRON, TOTAL	833	1040	801	3130	3150	1090
LEAD, TOTAL	1.7 J	3.2	11.5	10	6.5	3.3
MAGNESIUM, TOTAL	47.8	60.4	110	387	196	75.5
MANGANESE, TOTAL	1.8	2.8	3.1	7.4	6.4	1.9
NICKEL, TOTAL	3.3	6.2	2.4 U	2.5 U	1.3	4.9
POTASSIUM, TOTAL	146 U	137 U	151 U	248	91.4	72.9
SODIUM, TOTAL	6.5 U	11.7	6.7 U	10.3	26.7	12 U
VANADIUM, TOTAL	2.5 U	3.3	3.1	12.6	8.6	4.4
ZINC, TOTAL	1.5	1.8	2	4	2	1.2

MG/KG - milligram per kilogram
 J - value is estimated
 U - not detected
 UJ - not detected, value is estimated

TABLE 4-6
 SUBSURFACE SOIL - POSITIVE DETECTION SUMMARY
 SITE 54, CRASH CREW FIRE TRAINING BURN PIT
 REMEDIAL INVESTIGATION, CTO-0303
 MCAS, NEW RIVER, NORTH CAROLINA
 TAL METALS

LOCATION	54-SB05-01	54-SB05-04
DATE SAMPLED	03/11/95	03/11/95
DEPTH	1-3'	7-9'
ANALYTES (mg/kg)		
ALUMINUM, TOTAL	4190	344
ARSENIC, TOTAL	0.4 U	0.36 U
BARIUM, TOTAL	13.1	1.1 U
CALCIUM, TOTAL	2500	16.7 U
CHROMIUM, TOTAL	3.9	0.88
COBALT, TOTAL	0.4 U	0.37 U
COPPER, TOTAL	0.81	0.64 U
IRON, TOTAL	2350	125
LEAD, TOTAL	8.8	1.4
MAGNESIUM, TOTAL	146	16.3
MANGANESE, TOTAL	7.5	0.38
NICKEL, TOTAL	1.1	3.5
POTASSIUM, TOTAL	105	18
SODIUM, TOTAL	38.6	5 U
VANADIUM, TOTAL	5.8	0.54
ZINC, TOTAL	2.7	0.3 U

MG/KG - milligram per kilogram
 J - value is estimated
 U - not detected
 UJ - not detected, value is estimated

TABLE 4-7
GROUNDWATER - POSITIVE DETECTION SUMMARY
SITE 54, CRASH CREW FIRE TRAINING BURN PIT
REMEDIAL INVESTIGATION, CTO-0303
MCAS, NEW RIVER, NORTH CAROLINA
TCL ORGANICS

LOCATION DATE SAMPLED	54-GW01-01 03/28/95	54-GW02-01 03/28/95	54-GW03-01 03/28/95	54-GW04-01 03/28/95	54-GW05-01 03/28/95	54-GW06-01 03/28/95
VOLATILES (ug/l)						
CARBON DISULFIDE	10 U	10 U	10 U	10 U	10 U	10 U
1,2-DICHLOROETHENE (TOTAL)	5 J	10 U	10 U	10 U	10 U	8 J
TRICHLOROETHENE	10 U	10 U	10 U	10 U	10 U	10 U
BENZENE	5 J	10 U	10 U	10 U	10 U	8 J
TOLUENE	10 U	10 U	10 U	10 U	10 U	10 U
ETHYLBENZENE	10 U	10 U	10 U	10 U	10 U	10 U
XYLENE (TOTAL)	10 U	10 U	10 U	10 U	10 U	10 U
SEMIVOLATILES (ug/l)						
PHENOL	10 U	10 U	10 U	10 U	10 U	10 U
NITROBENZENE	10 U	10 U	10 U	10 U	10 U	10 U
2,4-DIMETHYLPHENOL	10 U	10 U	10 U	10 U	10 U	3 J
NAPHTHALENE	5 J	10 U	10 U	10 U	10 U	55
2-METHYLNAPHTHALENE	10 U	1 J	10 U	10 U	10 U	24
DIETHYLPHTHALATE	10 U	10 U	10 U	10 U	10 U	10
ANTHRACENE	10 U	10 U	10 U	10 U	10 U	10 U
DI-N-BUTYLPHTHALATE	10 U	10 U	10 U	10 U	10 U	10 U
BIS(2-ETHYLHEXYL)PHTHALATE	10 U	10 U	10 U	10 U	10 U	10 U

UG/L - microgram per liter
J - value is estimated
U - not detected
UJ - not detected, value is estimated

TABLE 4-7
GROUNDWATER - POSITIVE DETECTION SUMMARY
SITE 54, CRASH CREW FIRE TRAINING BURN PIT
REMEDIAL INVESTIGATION, CTO-0303
MCAS, NEW RIVER, NORTH CAROLINA
TCL ORGANICS

LOCATION DATE SAMPLED	54-GW07-01 03/28/95	54-GW08-01 04/18/95	54-GW09-01 04/18/95	54-GW10-01 04/17/95	54-TW01-01 03/12/95	54-TW02-01 03/12/95
VOLATILES (ug/l)						
CARBON DISULFIDE	10 U	10 U	10 U	4 J	10 U	10 U
1,2-DICHLOROETHENE (TOTAL)	10 U	10 U	10 U	10 U	10 U	10 U
TRICHLOROETHENE	10 U	10 U	10 U	10 U	10 U	10 U
BENZENE	10 U	10 U	10 U	10 U	10 U	9 J
TOLUENE	10 U	10 U	10 U	10 U	10 U	10 U
ETHYLBENZENE	10 U	10 U	10 U	10 U	10 U	6 J
XYLENE (TOTAL)	10 U	10 U	10 U	10 U	10 U	27
SEMIVOLATILES (ug/l)						
PHENOL	10 U	10 U	10 U	10 U	10 U	10 U
NITROBENZENE	10 U	10 U	10 U	10 U	10 U	10 U
2,4-DIMETHYLPHENOL	10 U	10 U	10 U	10 U	10 U	10 U
NAPHTHALENE	10 U	10 U	10 U	10 U	10 U	100
2-METHYLNAPHTHALENE	10 U	10 U	10 U	10 U	10 U	52
DIETHYLPHTHALATE	10 U	10 U	10 U	10 U	10 U	2 J
ANTHRACENE	10 U	10 U	10 U	10 U	10 U	10 U
DI-N-BUTYLPHTHALATE	10 U	10 U	2 J	1 J	10 U	10 U
BIS(2-ETHYLHEXYL)PHTHALATE	10 U	10 U	1 J	1 J	10 U	10 UJ

UG/L - microgram per liter
 J - value is estimated
 U - not detected
 UJ - not detected, value is estimated

TABLE 4-7
GROUNDWATER - POSITIVE DETECTION SUMMARY
SITE 54, CRASH CREW FIRE TRAINING BURN PIT
REMEDIAL INVESTIGATION, CTO-0303
MCAS, NEW RIVER, NORTH CAROLINA
TCL ORGANICS

LOCATION DATE SAMPLED	54-TW03-01 03/12/95	54-TW04-01 04/11/95	54-TW05-01 04/11/95	54-TW06-01 04/11/95	54-TW07-01 04/11/95
VOLATILES (ug/l)					
CARBON DISULFIDE	10 U	10 U	10 U	10 U	10 U
1,2-DICHLOROETHENE (TOTAL)	23	10 U	10 U	10 U	10 UJ
TRICHLOROETHENE	1 J	10 U	10 U	10 U	10 U
BENZENE	38	40	25	10 U	10 U
TOLUENE	83	22	10 U	10 U	10 U
ETHYLBENZENE	25	26	10 U	10 U	10 U
XYLENE (TOTAL)	130	30	10 U	10 U	10 U
SEMIVOLATILES (ug/l)					
PHENOL	100 U	1 J	11 U	10 U	10 U
NITROBENZENE	100 U	2 J	11 U	10 U	10 U
2,4-DIMETHYLPHENOL	100 U	11 U	11 U	10 U	10 U
NAPHTHALENE	240	56	99	10 U	1 J
2-METHYLNAPHTHALENE	160	44	16	10 U	10 U
DIETHYLPHTHALATE	37 J	3 J	1 J	10 U	10 U
ANTHRACENE	100 U	11 U	1 J	10 U	10 U
DI-N-BUTYLPHTHALATE	100 U	11 U	11 U	10 U	10 U
BIS(2-ETHYLHEXYL)PHTHALATE	100 U	11 U	11 U	10 U	10 U

UG/L - microgram per liter

J - value is estimated

U - not detected

UJ - not detected, value is estimated

TABLE 4-8
GROUNDWATER - POSITIVE DETECTION SUMMARY
SITE 54, CRASH CREW FIRE TRAINING BURN PIT
REMEDIAL INVESTIGATION, CTO-0303
MCAS, NEW RIVER, NORTH CAROLINA
TAL METALS

LOCATION DATE SAMPLED	54-GW01-01 03/28/95	54-GW02-01 03/28/95	54-GW03-01 03/28/95	54-GW04-01 03/28/95	54-GW05-01 03/28/95	54-GW06-01 03/28/95
ANALYTES (ug/l)						
ALUMINUM, TOTAL	206	30.1 U	85 U	219	116 U	109 U
ARSENIC, TOTAL	1.6 U	4.8	2.8	1.6 U	1.6 U	1.6 U
BARIUM, TOTAL	36.4	26.3	28.5	39.6	68.9	43.1
CALCIUM, TOTAL	4610	52300	68900	3460	6510	3810
CHROMIUM, TOTAL	2.9 U	2.9 U	2.9 U	2.9 U	2.9 U	2.9 U
COBALT, TOTAL	11.3	3 U	17.6	5.9	3 U	20.9
IRON, TOTAL	3620 J	13100 J	16800 J	572 J	193 J	1570 J
LEAD, TOTAL	2.8	39.7	1.9	1.6 U	1.6 U	4.9
MAGNESIUM, TOTAL	1810	4320	3550	1430	3940	2380
MANGANESE, TOTAL	640	31.3	1280	132	135	1160
NICKEL, TOTAL	10.8 U	10.8 U	10.8 U	10.8 U	10.8 U	10.8 U
POTASSIUM, TOTAL	685 U	3960	2920	1380	1570	885
SODIUM, TOTAL	9010	3390	4650	4040	7450	14300
ZINC, TOTAL	10.1 U	3.8 U	4.2 U	22 U	4.5 U	8.1 U

UG/L - microgram per liter
J - value is estimated
U - not detected

TABLE 4-8
GROUNDWATER - POSITIVE DETECTION SUMMARY
SITE 54, CRASH CREW FIRE TRAINING BURN PIT
REMEDIAL INVESTIGATION, CTO-0303
MCAS, NEW RIVER, NORTH CAROLINA
TAL METALS

LOCATION	54-GW07-01	54-GW08-01	54-GW09-01	54-GW10-01	54-TW01-01	54-TW02-01
DATE SAMPLED	03/28/95	04/18/95	04/18/95	04/17/95	03/12/95	03/12/95
ANALYTES (ug/l)						
ALUMINUM, TOTAL	24 U	121 U	107 U	5340	142 U	257 U
ARSENIC, TOTAL	1.6 U	1.7 U	1.7 U	3.2	1.9 U	1.9 U
BARIUM, TOTAL	27.2	30.2	43.6	40.6	59.5	29.2
CALCIUM, TOTAL	79000	91500	3230	8230	7930	6850
CHROMIUM, TOTAL	2.9 U	4.1 U	4.1 U	10.3	2.9 U	2.9 U
COBALT, TOTAL	3 U	3.4 U	9.4 U	6 U	3 U	3 U
IRON, TOTAL	229 J	249	886	5000	145 U	7510
LEAD, TOTAL	1.6 U	0.8 U	0.8 U	3.9	1 U	1 U
MAGNESIUM, TOTAL	2620	3240	2050	1570	6550	2430
MANGANESE, TOTAL	41.7	89.9	349	89.3	25.2	39.8
NICKEL, TOTAL	10.8 U	10.9 U	10.9 U	14.1	37.2	61.6
POTASSIUM, TOTAL	1570	1160	768 U	890	685 U	685 U
SODIUM, TOTAL	4620	4460	10500	4550	7510	10100
ZINC, TOTAL	9.3 U	6 U	8.2	24.7	3.8 U	17.2

UG/L - microgram per liter
J - value is estimated
U - not detected

TABLE 4-8
GROUNDWATER - POSITIVE DETECTION SUMMARY
SITE 54, CRASH CREW FIRE TRAINING BURN PIT
REMEDIAL INVESTIGATION, CTO-0303
MCAS, NEW RIVER, NORTH CAROLINA
TAL METALS

LOCATION	54-TW03-01
DATE SAMPLED	03/12/95
ANALYTES (ug/l)	
ALUMINUM, TOTAL	45 U
ARSENIC, TOTAL	24.7
BARIUM, TOTAL	16.7 U
CALCIUM, TOTAL	4830
CHROMIUM, TOTAL	2.9 U
COBALT, TOTAL	3 U
IRON, TOTAL	74100
LEAD, TOTAL	1 U
MAGNESIUM, TOTAL	3720
MANGANESE, TOTAL	141
NICKEL, TOTAL	19
POTASSIUM, TOTAL	685 U
SODIUM, TOTAL	27800
ZINC, TOTAL	3.8 U

UG/L - microgram per liter
J - value is estimated
U - not detected

TABLE 4-9
 GROUNDWATER - POSITIVE DETECTION SUMMARY
 SITE 54, CRASH CREW FIRE TRAINING BURN PIT
 REMEDIAL INVESTIGATION, CTO-0303
 MCAS, NEW RIVER, NORTH CAROLINA
 TAL DISSOLVED METALS

LOCATION	54-GW06D-01	54-TW02D-01
DATE SAMPLED	03/28/95	03/12/95
ANALYTES (ug/l)		
BARIUM, SOLUBLE	43.4	28.6
CALCIUM, SOLUBLE	4160	6680
COBALT, SOLUBLE	21.9	3 U
IRON, SOLUBLE	1130 J	8100
LEAD, SOLUBLE	1.6 U	7.4 J
MAGNESIUM, SOLUBLE	2490	2460
MANGANESE, SOLUBLE	1150	40.5
NICKEL, SOLUBLE	10.8 U	65.4
POTASSIUM, SOLUBLE	1630	1200
SODIUM, SOLUBLE	14700	9930
ZINC, SOLUBLE	5.6 U	12.8

UG/L - microgram per liter
 J - value is estimated
 U - not detected

SECTION 4.0 FIGURES

ASPHALT AREA

LOCATION	54-SB07
DATE SAMPLED	03/12/95
SEMIVOLATILES (ug/kg)	
BUTYLBENZYLPHTHALATE	50 J

LOCATION	54-SB08
DATE SAMPLED	03/11/95
SEMIVOLATILES (ug/kg)	
DI-N-OCTYL PHTHALATE	150 J

LOCATION	54-DD-SB01
DATE SAMPLED	03/10/95
SEMIVOLATILES (ug/kg)	
N-NITROSODIPHENYLAMINE (1)	160 J
PHENANTHRENE	98 J
FLUORANTHRENE	67 J
PYRENE	150 J

LOCATION	54-DD-SB04
DATE SAMPLED	03/10/95
SEMIVOLATILES (ug/kg)	
BUTYLBENZYLPHTHALATE	320 J

LOCATION	54-DD-SB03
DATE SAMPLED	03/10/95
SEMIVOLATILES (ug/kg)	
PHENANTHRENE	120 J
FLUORANTHRENE	62 J
PYRENE	99 J

- LEGEND**
- SB09 SOIL BORING LOCATION
 - ▨ MARSH
 - x-x- FENCE
 - ▨ ASPHALT ROAD OR AREA
 - - - - - GRAVEL ROAD
 - EDGE OF CREEK OR MARSH
 - - - - - CENTERLINE OF DRAINAGE SWALE
 - ~ TREE LINE
 - * ELECTRIC BOX
 - ▨ STRUCTURE

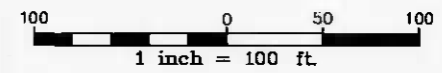
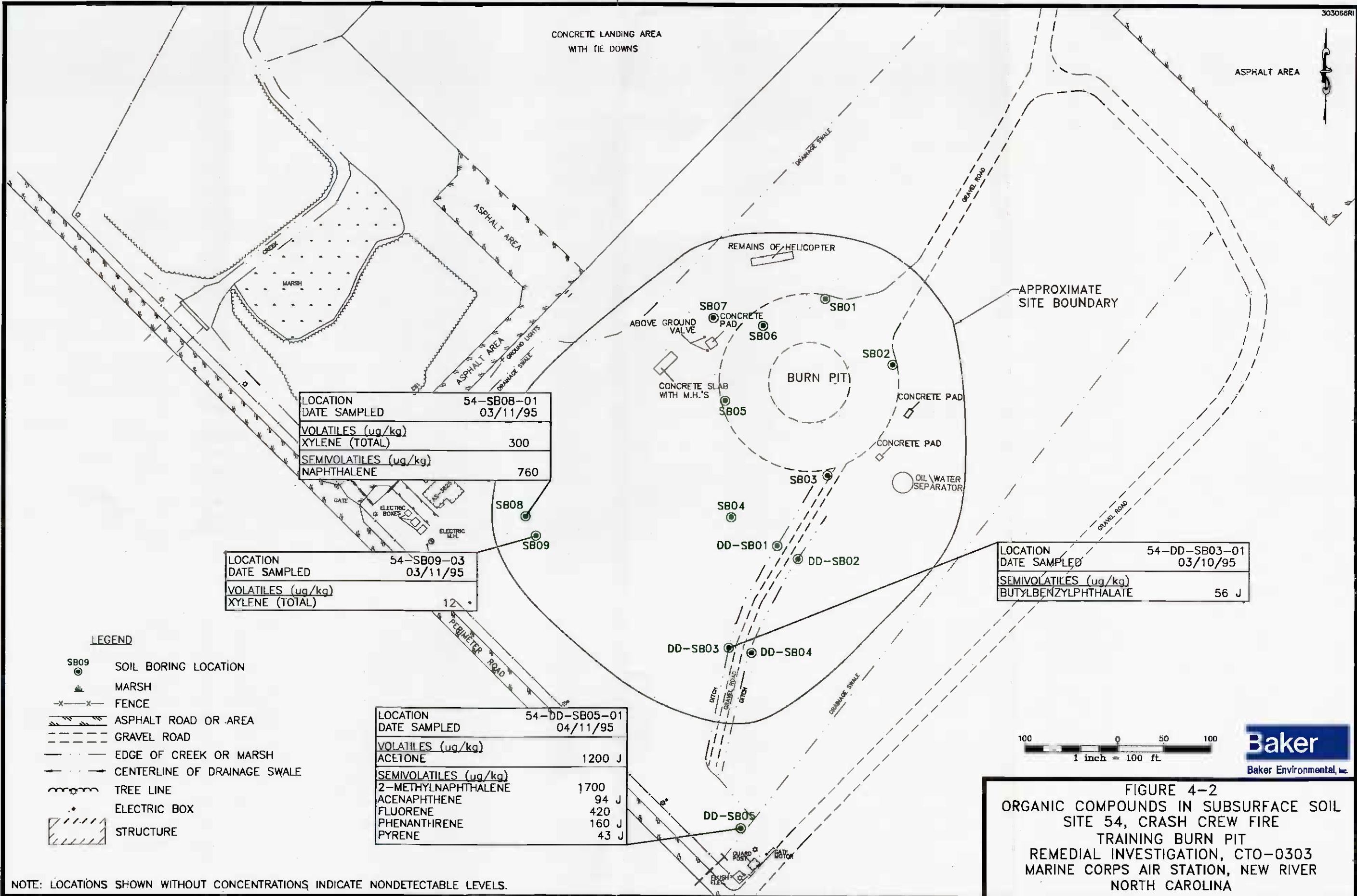


FIGURE 4-1
ORGANIC COMPOUNDS IN SURFACE SOIL
SITE 54, CRASH CREW FIRE
TRAINING BURN PIT
REMEDIAL INVESTIGATION, CTO-0303
MARINE CORPS AIR STATION, NEW RIVER
NORTH CAROLINA

NOTE: LOCATIONS SHOWN WITHOUT CONCENTRATIONS INDICATE NONDETECTABLE LEVELS.

01717AAB5Y



LOCATION	54-SB08-01
DATE SAMPLED	03/11/95
VOLATILES (ug/kg)	
XYLENE (TOTAL)	300
SEMIVOLATILES (ug/kg)	
NAPHTHALENE	760

LOCATION	54-SB09-03
DATE SAMPLED	03/11/95
VOLATILES (ug/kg)	
XYLENE (TOTAL)	12

LOCATION	54-DD-SB03-01
DATE SAMPLED	03/10/95
SEMIVOLATILES (ug/kg)	
BUTYLBENZYLPHTHALATE	56 J

LOCATION	54-DD-SB05-01
DATE SAMPLED	04/11/95
VOLATILES (ug/kg)	
ACETONE	1200 J
SEMIVOLATILES (ug/kg)	
2-METHYLNAPHTHALENE	1700
ACENAPHTHENE	94 J
FLUORENE	420
PHENANTHRENE	160 J
PYRENE	43 J

LEGEND

- SB09 SOIL BORING LOCATION
- ▨ MARSH
- x-x- FENCE
- ▨▨▨ ASPHALT ROAD OR AREA
- - - - GRVEL ROAD
- EDGE OF CREEK OR MARSH
- - - - CENTERLINE OF DRAINAGE SWALE
- ~ ~ ~ TREE LINE
- ELECTRIC BOX
- ▨▨▨ STRUCTURE

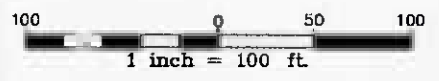
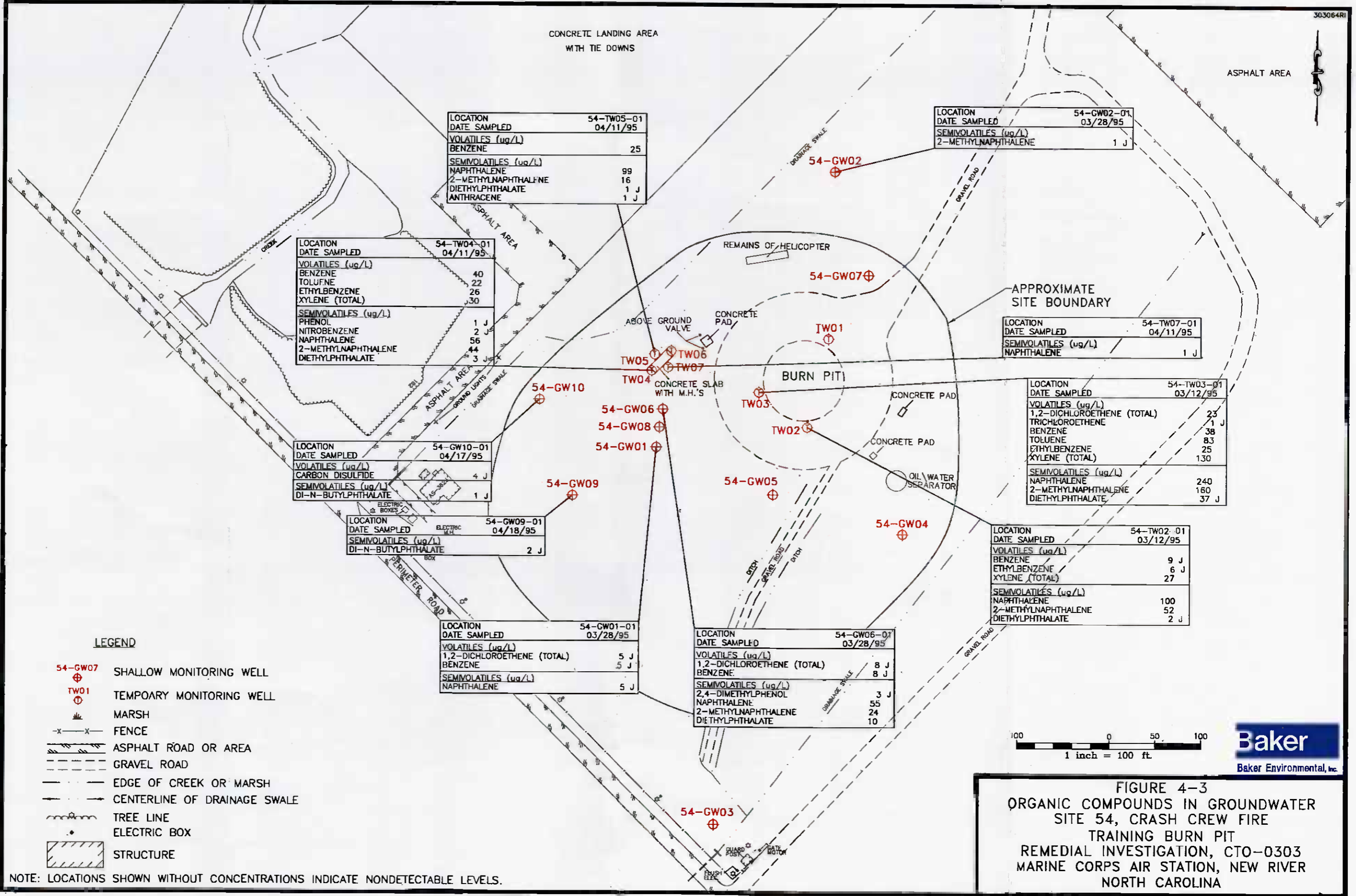


FIGURE 4-2
ORGANIC COMPOUNDS IN SUBSURFACE SOIL
SITE 54, CRASH CREW FIRE
TRAINING BURN PIT
REMEDIAL INVESTIGATION, CTO-0303
MARINE CORPS AIR STATION, NEW RIVER
NORTH CAROLINA

NOTE: LOCATIONS SHOWN WITHOUT CONCENTRATIONS INDICATE NONDETECTABLE LEVELS.



LOCATION	54-TW05-01
DATE SAMPLED	04/11/95
VOLATILES (ug/L)	
BENZENE	25
SEMIVOLATILES (ug/L)	
NAPHTHALENE	99
2-METHYLNAPHTHALENE	16
DIETHYLPHTHALATE	1 J
ANTHRACENE	1 J

LOCATION	54-GW02-01
DATE SAMPLED	03/28/95
SEMIVOLATILES (ug/L)	
2-METHYLNAPHTHALENE	1 J

LOCATION	54-TW04-01
DATE SAMPLED	04/11/95
VOLATILES (ug/L)	
BENZENE	40
TOLUENE	22
ETHYLBENZENE	26
XYLENE (TOTAL)	30
SEMIVOLATILES (ug/L)	
PHENOL	1 J
NITROBENZENE	2 J
NAPHTHALENE	56
2-METHYLNAPHTHALENE	44
DIETHYLPHTHALATE	3 J

LOCATION	54-TW07-01
DATE SAMPLED	04/11/95
SEMIVOLATILES (ug/L)	
NAPHTHALENE	1 J

LOCATION	54-TW03-01
DATE SAMPLED	03/12/95
VOLATILES (ug/L)	
1,2-DICHLOROETHENE (TOTAL)	23
TRICHLOROETHENE	1 J
BENZENE	38
TOLUENE	83
ETHYLBENZENE	25
XYLENE (TOTAL)	130
SEMIVOLATILES (ug/L)	
NAPHTHALENE	240
2-METHYLNAPHTHALENE	160
DIETHYLPHTHALATE	37 J

LOCATION	54-GW10-01
DATE SAMPLED	04/17/95
VOLATILES (ug/L)	
CARBON DISULFIDE	4 J
SEMIVOLATILES (ug/L)	
DI-N-BUTYLPHTHALATE	1 J

LOCATION	54-TW02-01
DATE SAMPLED	03/12/95
VOLATILES (ug/L)	
BENZENE	9 J
ETHYLBENZENE	6 J
XYLENE (TOTAL)	27
SEMIVOLATILES (ug/L)	
NAPHTHALENE	100
2-METHYLNAPHTHALENE	52
DIETHYLPHTHALATE	2 J

LOCATION	54-GW09-01
DATE SAMPLED	04/18/95
SEMIVOLATILES (ug/L)	
DI-N-BUTYLPHTHALATE	2 J

LOCATION	54-GW01-01
DATE SAMPLED	03/28/95
VOLATILES (ug/L)	
1,2-DICHLOROETHENE (TOTAL)	5 J
BENZENE	5 J
SEMIVOLATILES (ug/L)	
NAPHTHALENE	5 J

LOCATION	54-GW06-01
DATE SAMPLED	03/28/95
VOLATILES (ug/L)	
1,2-DICHLOROETHENE (TOTAL)	8 J
BENZENE	8 J
SEMIVOLATILES (ug/L)	
2,4-DIMETHYLPHENOL	3 J
NAPHTHALENE	55
2-METHYLNAPHTHALENE	24
DIETHYLPHTHALATE	10

LEGEND

- 54-GW07 ⊕ SHALLOW MONITORING WELL
- TW01 ⊕ TEMPORARY MONITORING WELL
- ▬ MARSH
- x-x- FENCE
- ▬▬▬ ASPHALT ROAD OR AREA
- - - - - GRAVEL ROAD
- — — — — EDGE OF CREEK OR MARSH
- - - - - CENTERLINE OF DRAINAGE SWALE
- ~ ~ ~ ~ ~ TREE LINE
- ELECTRIC BOX
- ▭ STRUCTURE

NOTE: LOCATIONS SHOWN WITHOUT CONCENTRATIONS INDICATE NONDETECTABLE LEVELS.

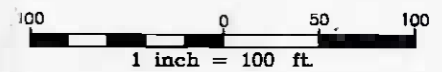


FIGURE 4-3
ORGANIC COMPOUNDS IN GROUNDWATER
SITE 54, CRASH CREW FIRE
TRAINING BURN PIT
REMEDIAL INVESTIGATION, CTO-0303
MARINE CORPS AIR STATION, NEW RIVER
NORTH CAROLINA

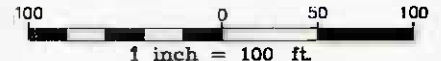
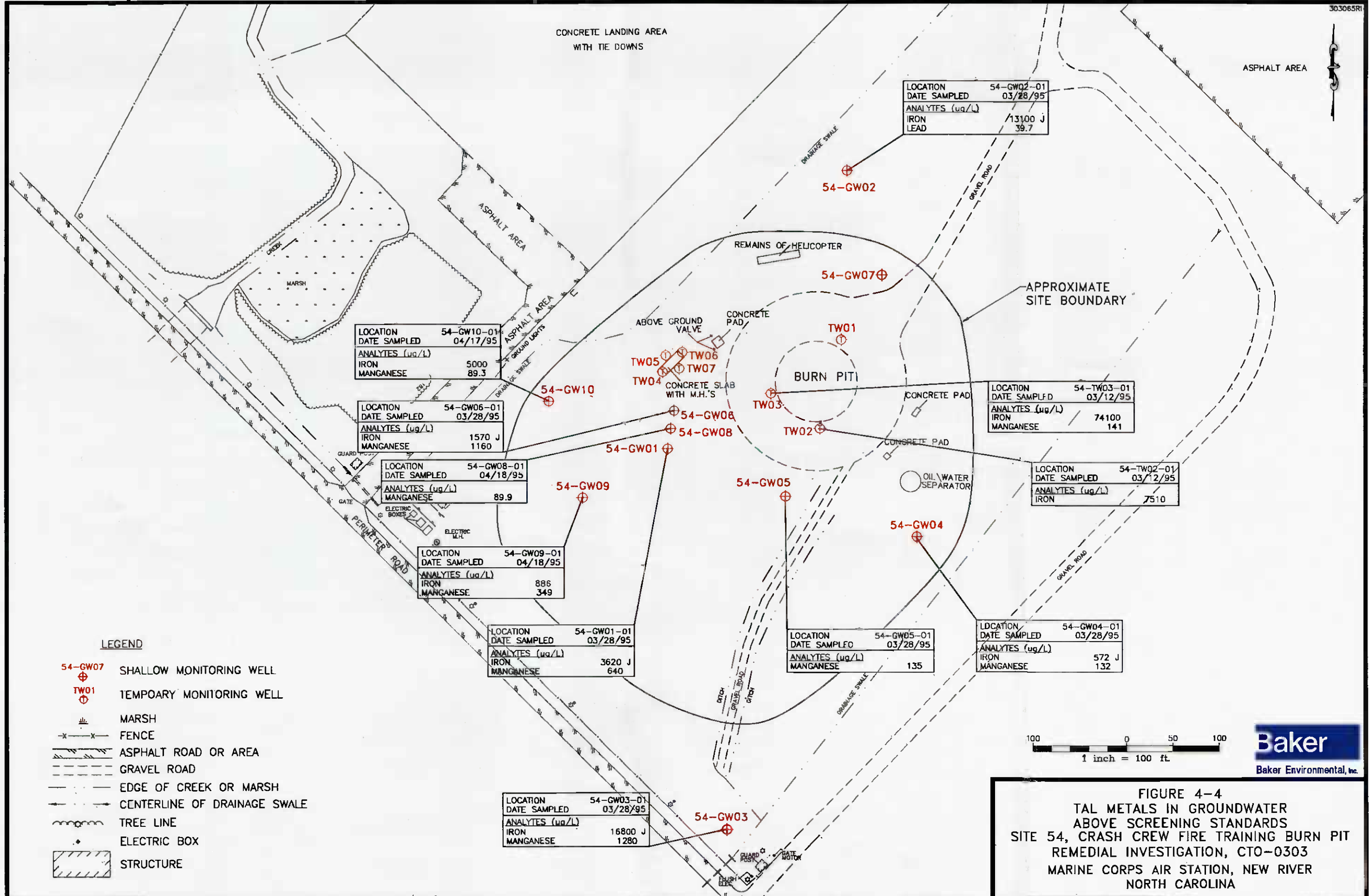


FIGURE 4-4
TAL METALS IN GROUNDWATER
ABOVE SCREENING STANDARDS
SITE 54, CRASH CREW FIRE TRAINING BURN PIT
REMEDIAL INVESTIGATION, CTO-0303
MARINE CORPS AIR STATION, NEW RIVER
NORTH CAROLINA

5.0 CONTAMINANT FATE AND TRANSPORT

The potential for a contaminant to migrate and persist in an environmental medium is critical when evaluating the potential for a chemical to elicit an adverse human health or ecological effect. The environmental mobility of a chemical is influenced by its physical and chemical properties, the physical characteristics of the site, and the site chemistry. This section presents a discussion of the various physical and chemical properties of significant contaminants in Site 54 media discussed in Section 4.0, and their fate and transport in the environment.

5.1 Chemical and Physical Properties Impacting Fate and Transport

Table 5-1 presents the physical and chemical properties associated with the organic compounds detected during this investigation. These properties determine the inherent environmental mobility and fate of a contaminant. The properties of interest include:

- Vapor pressure
- Water solubility
- Octanol/water partition coefficient
- Organic carbon adsorption coefficient (sediment partition)
- Specific gravity
- Henry's Law constant

A discussion of the environmental significance of each of these properties follows.

Vapor pressure provides an indication of the rate at which a chemical may volatilize. It is of primary significance at environmental interfaces such as surface soil/air and surface water/air. Volatilization can be important when evaluating groundwater and subsurface soils, particularly when selecting remedial technologies. Vapor pressure for monocyclic aromatics is generally higher than vapor pressures for PAHs. Contaminants with higher vapor pressures (e.g., VOCs) will enter the atmosphere at a quicker rate than the contaminants with low vapor pressures (e.g., PCBs).

The rate at which a contaminant is leached from soil by infiltrating precipitation is proportional to its water solubility. More soluble contaminants are usually more readily leached than less soluble contaminants. The water solubilities indicate that the volatile organic contaminants, including monocyclic aromatics, are usually several orders-of-magnitude more soluble than PAHs. Consequently, highly soluble compounds such as the chlorinated VOCs will go into solution faster and possibly in greater concentrations than less soluble compounds. The solubility of a specific compound is dependent on the chemistry of the groundwater and aquifer material. Factors such as groundwater pH, Eh (redox potential), temperature, and the presence of other compounds can greatly affect the solubility.

The octanol/water partition coefficient (K_{ow}) is the ratio of the chemical concentration in octanol divided by the concentration in water. The octanol/water partition coefficient has been shown to correlate well with bioconcentration factors in aquatic organisms and adsorption to soil or sediment. Specifically, a linear relationship between octanol/water partition coefficients and the uptake of chemicals by fatty tissues of animal and human receptors (the bioconcentration factor - BCF) has been established (Lyman et al., 1982). The coefficient is also useful in characterizing the sorption of compounds by organic soils where experimental values are not available.

The organic carbon adsorption coefficient (K_{oc}) indicates the tendency of a chemical to adhere to the organic carbon in soil particles. The solubility of a chemical in water is inversely proportional to the K_{oc} . Contaminants with high soil/sediment adsorption coefficients generally have low water solubilities. For example, contaminants such as PAHs are relatively immobile in the environment, are preferentially bound to the soil, and therefore have a higher K_{oc} value. These compounds are not subject to aqueous transport to the extent of compounds with higher water solubilities. Mechanical activities (e.g., erosion) and the physical characteristics of surface soils may, however, increase the mobility of these bound soil contaminants.

Specific gravity is the ratio of a given volume of pure chemical at a specified temperature to the weight of the same volume of water at a given temperature. Its primary use is to determine whether a contaminant will have a tendency to "float" or "sink" (as an immiscible liquid) in water if it exceeds its corresponding water solubility.

Vapor pressure and water solubility are of use in determining volatilization rates from surface water bodies and from groundwater. These two parameters can be used to estimate an equilibrium concentration of a contaminant in the water phase and in the air directly above the water. This relationship is expressed as Henry's Law Constant.

A quantitative assessment of mobility has been developed that uses water solubility (S), vapor pressure (VP), and organic carbon partition coefficient (K_{oc}) (Laskowski, 1983). This value is referred to as the Mobility Index (MI). It is defined as:

$$MI = \log((S*VP)/K_{oc})$$

A scale to evaluate MI as presented by Ford and Gurba (1984) is:

<u>Relative MI</u>	<u>Mobility Description</u>
> 5	extremely mobile
0 to 5	very mobile
-5 to 0	slightly mobile
-10 to -5	immobile
< -10	very immobile

The mobility index for each organic analyte detected at Site 54 is presented on Table 5-1.

5.2 Contaminant Transport Pathways

Based on the evaluation of existing conditions at Site 54, the following potential contaminant transport pathways have been identified.

- Windblown dust
- Leaching of soil contaminants to groundwater
- Migration of groundwater contaminants, laterally and vertically
- Migration of contaminants in runoff (surface water)

Contaminant concentrations may be affected by one or more mechanisms during transport. Contaminants may be physically transformed by volatilization or precipitation. Contaminants may

be chemically transformed through photolysis, hydrolysis or oxidation/reduction. Contaminants may be biologically transformed by biodegradation. Additionally, contaminants may accumulate in one or more media. Since different transformation mechanisms are important for different contaminants, these mechanisms are discussed as necessary in Section 5.3.

The paragraphs which follow describe the potential transport pathways listed above with respect to significant compound concentrations. Significant compound concentrations refers to those compounds discussed in Section 4.0 frequently occurring above criteria comparisons. Specific fate and transport concerns are discussed in Section 5.3.

5.2.1 Windblown Dust

Semivolatiles, including PAHs, were observed in surface soil samples from a few, scattered locations at Site 54 (Figure 4-1). Wind serves as a contaminant transport pathway agent by eroding exposed soil and blowing it off site. This process is influenced by wind velocity, the grain size/density of the soil/sediment particles, moisture conditions, and the amount of vegetative cover over the soil or sediment. Organic compounds with high K_{oc} values adsorb to organic matter in the soil.

A majority of the surface area of Site 54 is vegetated. This vegetation minimizes the likelihood of fugitive dust generation.

5.2.2 Leaching of Soil Contaminants to Groundwater

Volatiles and semivolatiles were detected in surface and/or subsurface soil samples at Site 54. Most of these occurrences were in a drainage ditch (Figures 4-1 and 4-2). Volatiles and semivolatiles were detected in groundwater samples collected from wells west and southwest of the burn pit. Additionally, iron and manganese were detected in groundwater samples from most wells at the site.

Contaminants that adhere to soil particles or have accumulated in soil pore spaces can leach and migrate vertically to the groundwater as a result of infiltration of precipitation. The rate and extent of this leaching is influenced by the depth to the water table, amount of precipitation, rate of infiltration, the physical and chemical properties of the soil, and contaminant.

5.2.3 Migration of Groundwater Contaminants

Organics and inorganics leaching from soil into groundwater can migrate as dissolved constituents in groundwater in the direction of groundwater flow. Three general processes govern the migration of dissolved constituents within groundwater: advection, dispersion, and retardation. Advection is a process by which solutes are carried by groundwater movement. Dispersion occurs by the mixing of contaminated and uncontaminated water during advection. Retardation is a slowing of contaminant migration caused by the reaction of the solute with the aquifer soil.

Advection is the process by which moving groundwater carries dissolved solutes (Fetter, 1988). Groundwater flow velocities at Site 54 were determined by using a variation of Darcy's equation (discussed in Section 2.5.4). Groundwater flow velocities in the surficial aquifer underlying Site 54 range from 0.16 to 1.25 feet/day, or 58.4 to 456.3 feet/year. Groundwater in the surficial aquifer flows from east to west and southwest, likely discharging to an unnamed tributary of Southwest Creek. The vertical groundwater flow gradient, as calculated between wells 54-GW01 and

54-GW08, is approximately 0.17 feet/foot. This vertical flow gradient is within the range of horizontal flow gradients.

Dispersion results from two basic processes; molecular diffusion and mechanical mixing. The kinetic activity of dissolved solutes results in diffusion of solutes from a zone of high concentration to a zone of lower concentration. Dispersion can occur in three directions, longitudinal (in the direction of flow), transverse (horizontally perpendicular to longitudinal), and vertical. Dispersion is largely scale dependent (i.e., the greater the area over which it is measured, the larger the dispersion value). Furthermore, longitudinal dispersion is often observed to be markedly greater than dispersion in the transverse direction of flow. It is often assumed that transverse dispersion is one-tenth longitudinal dispersion (Nichols, 1993). Lacking detailed site studies to determine dispersion, the parameter can be estimated to be one-tenth of the length of the flow path, in the same lithologies (Fetter, 1988).

Retardation is a process whereby a solute concentration is reduced through a chemical, biological or radioactive change. Solute can be categorized in two broad classes: conservative and reactive. Conservative solutes do not react with aquifer soil. Reactive solutes will interact with the soil encountered along the flow path through adsorption, partitioning, ion exchange, and other processes. The retardation factor (R) can be calculated by the following equation (Fetter, 1988):

$$R = 1 + (P_b/n)(K_d)$$

where:

- P_b = dry bulk density of the soil
- n = porosity of the soil
- k_d = distribution coefficient for the solute with the soil (K_{oc} of the solute times the TOC content of the soil)

The following is a summary of estimated retardation factors for VOCs and SVOC detected in multiple groundwater samples at Site 54:

<u>Solute</u>	<u>Retardation Factor</u>
1,2-Dichloroethene	1.77
Benzene	2.19
Xylene (total)	4.44
Toluene	5.30
Naphthalene	16.37
2-Methylnaphthalene	16.37
Ethylbenzene	16.77

Retardation factor calculations are presented in Appendix O. The lower the retardation factor, the faster the migration rate. These factors are estimated because of the lack of site-specific data, including TOC analytical data, bulk density and porosity. It is common however, to estimate retardation factors. The relative differences are useful for describing plume characteristics.

1,2-Dichloroethene(total), trichloroethene, and BTEX have been detected in groundwater samples at Site 54. The presence of these compounds is consistent with past use of waste fuel oil in the burn

pit. Natural biodegradation of 1,2-dichloroethene and trichloroethene is slower compared to BTEX according to U.S. Department of Health and Human Services' (USDHHS) toxicological profile manuals for these compounds. Additionally, these manuals as well as other sources show that trichloroethene will degrade to cis-1,2-dichloroethene and trans-1,2-dichloroethene given the appropriate physical and chemical conditions at a site.

Immiscible liquids are typically the result of a large quantity spill or leak, or dumping with incomplete combustion. Subsurface transport of the immiscible contaminants is governed by a set of factors different from those of dissolved contaminants. A contaminant that is present in water above its solubility concentration will form an immiscible liquid. Based on the specific gravity of the contaminant, it will either float or sink in the water.

Movement of immiscible liquids is controlled by entry conditions and flow conditions (Feenstra et al., 1995). Entry of an immiscible liquid to a subsurface system is primarily controlled by the capillary phenomena. These phenomena arise from the fact that an interfacial tension is present between two mutually immiscible liquids in small pore space. Once in a subsurface system, the rate and direction of flow depends on the density and viscosity of the fluid, the pressure driving the fluid, the hydraulic conductivity of the formation, and the degree of saturation of the fluid in the formation (Feenstra et al., 1995). Fluids denser than water will sink, fluids lighter than water will float. The driving pressure is related to the amount of fluid released into the environment. An immiscible liquid will flow faster where the fluid is already present in the formation. Contaminants from the immiscible liquids may then dissolve into groundwater, volatilize from groundwater to ground air, evaporate directly into ground air or sorb from groundwater to solid surfaces.

Metals are inherent to soil and sediment, and groundwater. For this reason, concentrations of metals must be discussed with respect to background or natural concentrations. Metal solutes behave differently than organic solutes. While the fate and transport of metal solutes generally occur by the same three process described above, the fate of metals is significantly affected by groundwater and aquifer matrix chemistry. The concentration of metals and their movement are dependent on such things as ion exchange capacity, pH, and redox potential. Table 5-2 presents an assessment of relative environmental mobilities of inorganics as a function of Eh and pH. Different metals will behave differently under the same conditions. Metal solutes therefore, need to be examined individually. Section 5.3.3 examines the occurrence of individual metals at Site 54.

5.2.4 Migration of Contaminants in Runoff (Surface Water)

Semivolatile compounds were detected in several soil samples collected from the drainage ditches, south of the burn pit. The detected compounds are likely due to surface water runoff from the burn pit. Over time, the surface water infiltrates downward transporting the compounds and impacting the underlying soils.

5.3 Fate and Transport Summary

The paragraphs which follow discuss transport mechanisms and the fate for the significant contaminants discussed in Section 4.0.

5.3.1 Volatile and Semivolatile Organic Compounds

VOCs tend to be mobile in environmental media as indicated by their presence in groundwater and their corresponding MI values/retardation factors. Their environmental mobility is a function of high water solubilities, high vapor pressures, low K_{ow} and K_{oc} values, and high mobility indices. Because VOCs are highly mobile in soil, they will readily leach to underlying groundwater. SVOCs are less mobile than VOCs due to lower water solubilities, vapor pressures, and higher K_{ow} and K_{oc} values as compared with VOCs.

Figure 4-3 shows the distribution of the VOCs and SVOCs in groundwater. Based on each solute's MI value/retardation factor, each solute is expected to migrate at a different rate. Additionally, over time, trichloroethene will be transformed to 1,2-dichloroethene. Based on the groundwater flow direction and relative retardation factors, the following conceptual fate and transport model has been developed:

- 1) Two distinct plumes are evident at Site 54. The burn pit is the primary source area for VOC and SVOC contaminants in groundwater. A secondary plume, however, is apparent downgradient of the UST. Assuming that only one plume exists, and given the similar distances of wells 54-TW04, 54-GW01, and 54-GW06 from the burn pit, similar contaminants and/or contaminant concentrations would be expected in these three wells. Total xylenes and toluene, relatively low-mobile compounds, were detected in well 54-TW04, but not in wells 54-GW01 or 54-GW06. Additionally, the presence of total xylenes and toluene in well 54-TW04 at comparable levels to benzene and ethylbenzene suggests the wells are in close proximity to a source area (e.g., wells 54-TW02 and 54-TW03). The fact that the UST passed a tightness test suggests that over filling and/or spills on the ground surface are the likely sources of groundwater contamination.
- 2) VOCs and SVOCs related to fuel oil have been detected in monitoring wells west and hydraulically downgradient of the burn pit. The contaminants were not detected in wells located upgradient (e.g., 54-TW01) or sidegradient (e.g., 54-GW04) of the burn pit. VOCs and SVOCs have been detected in three temporary wells surrounding the UST, two of which are located downgradient of the UST.
- 3) Groundwater advection appears to have transported contaminants horizontally downgradient from the burn pit. It is apparent that groundwater has not transported the contaminants downward to the lower portion of the surficial aquifer based on analytical data from well 54-GW08 which is screened within this zone. VOCs and SVOCs were not detected in well 54-GW08. The presence of a clay layer west and south of the burn pit appears to be inhibiting vertical contaminant migration.
- 4) Relatively less mobile SVOC compounds are present in wells 54-GW01 and 54-GW06. This suggests that the leading edge of the plume, consisting of more mobile VOCs (benzene and 1,2-dichloroethene) is between wells 54-GW01 and 54-GW06, and wells 54-GW09 and 54-GW10.
- 5) Lateral plume limits may be located northwest of well 54-GW05 and south of well 54-GW06.

Xylenes were detected in two subsurface soil samples from an area southwest of the burn pit. Naphthalene was also detected in one of these samples. No monitoring wells are located downgradient of this area to assess the potential for these contaminants to leach into groundwater.

5.3.2 Polynuclear Aromatic Hydrocarbons (PAHs)

PAH contamination was encountered in soil samples collected from a drainage ditch leading from, and located south of the burn pit. PAHs were detected along the entire length of the ditch. Low water solubilities and high K_{ow} and K_{oc} values indicate a strong tendency for PAHs to adsorb to soils, and be immobile.

The presence of PAHs can be a result of incomplete combustion or as primary constituents of fuels or tars. The total PAH concentration generally decreases with distance away from the burn pit. The exception is 54-DD-SB05, where the total PAH concentration is greatest. Given this information, the most likely scenario is that charred soils (with sorbed PAHs) were washed from the burn pit area during rain events to and through the drainage ditch. These washed soils may have accumulated in front of a culvert leading under Perimeter Road, represented by 54-DD-SB05.

5.3.3 Metals

According to Section 4.0, the presence of metals in soil above criteria levels is limited. The dissolution of these metals from soils to groundwater has generally not resulted in concentrations exceeding Federal MCLs or state drinking water standards.

One exception to the above statement is the presence of iron and manganese. Both metals are naturally occurring in soils, and have frequently been detected in groundwater samples well above comparison criteria. The presence of elevated iron and manganese in groundwater may be related to changes in the geochemistry due to the presence of organic compounds. Detailed studies of two separate petroleum leaks in the United States show that elevated concentrations of iron and manganese can be associated with petroleum contaminated groundwater (NGWA, 1993). One study shows that iron concentrations in groundwater contaminated by petroleum can be substantially increased by chemical reduction involving ferric hydroxides and complexation reactions with organic ligands. The other study shows an area of increased mobilization of iron and manganese developing due to changes in pH, Eh, and dissolved oxygen in the presence of petroleum groundwater contamination.

A review of Figure 4-4 shows that some of the highest iron and manganese concentrations occur within the contaminant plume. However, the contaminated plume does not account for all elevated iron and manganese. Wells outside the contaminant plume, including an upgradient well, also exhibit elevated iron and manganese concentrations.

Previous studies by Baker and others indicate that iron and manganese are ubiquitous in all media at MCB, Camp Lejeune. These studies show that concentrations of iron and manganese are variable and can occur in sediments, surface water and groundwater at levels exceeding comparison criteria. It appears that elevated levels of iron and manganese in a particular media may not be associated with disposal, but rather be representative of natural conditions.

In a study of trace elements in a coastal plain estuary (Cross, et. al., 1970), iron, manganese, and zinc were found in sediments, surface water, and worm tissue. The study was conducted over a two year

period in a river estuary near Morehead City, North Carolina (approximately 40 miles northeast of Camp Lejeune). Multiple samples of surface water, sediment, and worms were collected monthly. Analysis was performed on an extract of the sediments. This study found that iron and manganese levels varied temporally. Levels decreased in samples collected at or near the Atlantic Ocean. The highest concentrations of iron, manganese, and zinc occurred inland, in a station in the Newport River. At this station, the mean levels of iron in sediment extract were reported to range from 380 µg/g to 1,800 µg/g, while manganese ranged from 12 µg/g to 71 µg/g. Median level of iron in surface water was 300 µg/L, while manganese was 22 µg/L. The study found that iron was most abundant, followed by manganese.

According to a study of chemical characteristics of natural waters (Hem, 1992), iron and manganese can occur in water through natural effects. Hem cited a report that manganese was observed at 1.0 mg/L in small streams due to low dissolved oxygen levels. Hem also reported that manganese can occur in groundwater above 1.0 mg/L. Manganese can dissolve into groundwater from manganese oxide coatings on soil/sediment particles. Manganese is a significant constituent of many igneous and metamorphic rocks. Small amounts of manganese are commonly present in limestone and dolomite, substituting for calcium. Partially cemented limestone and calcareous sediments are common in the Camp Lejeune area, and were observed at Site 36.

Hem observed iron in surface water at 1.4 mg/L due to organic complexing. Typically, iron concentrations in surface water is on the order of 10 µg/L. Iron can occur in groundwater at levels as high as 50 mg/L given certain chemical conditions (a pH between 6 and 8 SU and a bicarbonate activity less than 61 mg/L). A high level of dissolved iron can occur with oxidation of ferrous sulfides. Sulfur is altered to sulfate releasing ferrous iron. Metallic sulfides are common in sedimentary and igneous rocks, or soils/sediments with those source rocks. Hem reported, "The availability of iron for aqueous solutions is strikingly affected by environmental conditions, especially changes in degree or intensity of oxidation or reduction.

Iron and manganese were detected at significant levels in groundwater at Site 54. The average concentration of iron and manganese in groundwater samples is 9.5 mg/L and 0.3 mg/L, respectively. These concentrations appear within natural conditions described by Hem. Additionally, most of the individual data points are also within natural conditions.

Lead was detected in 5 of 13 groundwater samples. The highest occurrence of lead was in well 54-GW02, located upgradient of the burn pit. Based on that, it appears that lead may not be associated with the burn pit.

5.4 References

Cross, Ford A., Duke, Thomas W., and James N. Willis. 1970. "Biogeochemistry of Trace Elements in a Coastal Plain Estuary: Distribution of Manganese, Iron, and Zinc in Sediments, Water, and Polychaetous Worms." Chesapeake Science. Vol. 11, No. 4, 221-234. December 1970.

Feenstra S., Cherry, J.A., and B.L. Parker. 1995. Dense Chlorinated Solvents in Groundwater: Background History of the Problem. July 1995.

Fetter, C.W. 1986. Applied Hydrogeology. Charles E. Merrill Publishing Co., Columbus, Ohio.

Howard, Philip H. 1989. Handbook of Environmental Fate and Exposure Data for Organic Chemicals - Pesticides. Lewis Publishers. Chelsea, Michigan.

Howard, Philip H. 1990. Handbook of Environmental Fate and Exposure Data for Organic Chemicals - Large Production and Priority Pollutants. Lewis Publishers. Chelsea, Michigan.

Howard, Philip H. 1991. Handbook of Environmental Fate and Exposure Data for Organic Chemicals - Solvents. Lewis Publishers. Chelsea, Michigan.

Laskowski, D.A., Goring, C.A., McCall, P.J., and R.L. Swann. 1983. "Terrestrial Environment in Environmental Risk Analysis for Chemicals." Environmental Risk Analysis for Chemicals. R.A. Conways, ed., Van Nostrand Reinhold Company, New York, New York.

Lyman, W.J., Rechl, W.F. and D.H. Rosenblatt. 1982. Handbook of Chemical Property Estimation Methods. McGraw-Hill, Inc., New York.

Nichols. 1993. Principle of Subsurface Contaminant Fate and Transport Modeling. (Seminar)

Superfund Chemical Data Matrix (SCDM). 1991. United States Environmental Protection Agency Hazardous Site Evaluation Division. December 1991.

Swartbaugh, et al. "Remediating Sites Contaminated with Heavy Metals." Hazardous Materials Control. November/December 1992.

United States Environmental Protection Agency (USEPA). 1986. Superfund Public Health Evaluation Manual. Office of Emergency Response. Washington, D.C. October, 1986. EPA/540/1-86/060.

SECTION 5.0 TABLES

TABLE 5-1

ORGANIC PHYSICAL AND CHEMICAL PROPERTIES
 SITE 54, CRASH CREW FIRE TRAINING BURN PIT
 REMEDIAL INVESTIGATION CTO-0303
 MCAS, NEW RIVER, NORTH CAROLINA

Contaminants of Potential Concern	Vapor Pressure (mm Hg)	Water Solubility (mg/L)	Log K _{ow}	K _{oc}	Specific Gravity (g/cm ³)	Henry's Law Constant (atm-m ³ /mole)	Mobility Index
Volatiles							
1,2-Dichloroethene (cis)	208	3500	0.70	49	-	7.59E-03	-
1,2-Dichloroethene (trans)	324	6300	0.48	59	1.26	6.56E-03	2.9
Benzene	95.2	1750	2.12	83	0.879	5.59E-03	3.3
Toluene	28.1	535	2.73	300	0.867	6.37E-03	1.7
Semivolatiles							
Nitrobenzene	0.15	1900	1.85	36	-	-	-
Naphthalene	0.082	31.7	3.30	2.74-3.53	1.152	4.83E-04	NA
2-Methylnaphthalene ⁽¹⁾	0.082	31.7	3.30	2.74-3.53	1.152	4.83E-04	NA

Notes:

NA = Not Available

⁽¹⁾ = Values substituted from naphthalene.

References:

Howard, 1989-1991
 USEPA, 1986 (SPHEM)
 SCDM, 1991

TABLE 5-2

RELATIVE MOBILITIES OF METALS AS A FUNCTION OF ENVIRONMENTAL CONDITIONS (Eh, pH)
 SITE 54, CRASH CREW FIRE TRAINING BURN PIT
 REMEDIAL INVESTIGATION CTO-0303
 MCAS, NEW RIVER, NORTH CAROLINA

Relative Mobility	Environmental Conditions			
	Oxidizing	Acidic	Neutral/ Alkaline	Reducing
Very high			Se	
High	Se, Zn	Se, Zn, Cu, Ni, Hg, Ag		
Medium	Cu, Ni, Hg, Ag, As, Cd	As, Cd	As, Cd	
Low	Pb, Ba, Se	Pb, Ba, Be	Pb, Ba, Be	
Very Low	Fe, Cr	Cr	Cr, Zn, Cu, Ni, Hg, Ag	Cr, Se, Zn, Cu, Ni, Hg, Pb, Ba, Be, Ag

Notes:

Se = Selenium	Cd = Cadmium
Zn = Zinc	Ba = Barium
Cu = Copper	Pb = Lead
Ni = Nickel	Fe = Iron
Hg = Mercury	Cr = Chromium
Ag = Silver	Be = Beryllium
As = Arsenic	Zn = Zinc

Source: Swartzbaugh, et al. "Remediating Sites Contaminated with Heavy Metals."
 Hazardous Materials Control, November/December 1992.

6.0 BASELINE HUMAN HEALTH RISK ASSESSMENT

The following subsections present the baseline human health risk assessment (BRA) conducted for Site 54, Crash Crew Fire Training Burn Pit. This assessment was performed in accordance with the USEPA document Risk Assessment Guidance for Superfund, Human Health Evaluation Manual: Part A (USEPA, 1989). The purpose of the BRA is to assess whether the contaminants of potential concern (COPCs) at the site pose a current or future risk to human health in the absence of remedial action. COPCs are site-related contaminants used to quantitatively estimate human exposures and associated potential health effects. Because the purpose of the risk assessment is to estimate the degree of risk to human health and to be protective of human health, the approach of the USEPA guidance is designed to be conservative. This protectiveness is achieved by the use of assumptions and models that result in upper bound estimates of risk, i.e., the true or actual risk is expected to fall between the estimated value and zero. As a result, the actual site risks are unlikely to exceed the estimated upper bound values and are probably lower than the calculated risks. The following paragraphs present a brief overview of the risk assessment process and how the assessment affects further activity at the sites.

For the BRA, both current and future land use exposure scenarios were assumed for the site. The current scenario reflects potential human exposure pathways to the COPCs that presently exist at the site (i.e., exposure pathways currently available). Likewise, the future use scenario represents exposure pathways that are conceivable in the future (e.g., residential development). The future use is typically determined by zoning and the environmental setting of the site. The development of current and future use exposure scenarios is consistent with the methodology for baseline risk assessment, as specified by USEPA.

The National Contingency Plan (NCP) stipulates a range of acceptable cancer risk levels of 1×10^{-4} to 1×10^{-6} for total risk at a hazardous waste site (USEPA, 1990). These cancer risk levels represent the probability of an individual developing cancer over his or her lifetime if exposed to the COPCs at the site. For example, a risk level of 1×10^{-6} is the probability that one person in 1,000,000 exposed persons will develop cancer in a lifetime. The total noncarcinogenic acceptable risk level is a hazard index of less than or equal to 1.0. This noncancer risk level depicts a level at or below which adverse systemic effects are not expected in the exposed population.

A remedial action is recommended when either the total cancer or noncancer risks are above the criteria established by the NCP. Some form of remedial action also is necessary when either the current or future exposure point concentrations at the site are above the applicable or suitable analogous standards (e.g., maximum contaminant levels [MCLs] for drinking water) for those COPCs for which standards exist. When a remedial action is necessary, applicable or relevant and appropriate requirements (ARARs) and/or risk-based cleanup levels are used in determining acceptable concentrations in the environmental media. No remedial response is required when the cancer and noncancer criteria and the ARARs are not exceeded.

6.1 Introduction

The BRA investigates the potential for COPCs to affect human health and/or the environment, both now and in the future, under a "no further remedial action scenario." The BRA process evaluates the data generated during the sampling and analytical phase of the RI, identifying areas of interest and COPCs with respect to geographical, demographic, and physical and biological characteristics of the study area. These, combined with the current understanding of physical and chemical

properties of the site-associated constituents (with respect to environmental fate and transport processes), are then used to estimate the concentrations of contaminants at the end points of logical exposure pathways. Finally, contaminant intakes by hypothetical receptors are determined and combined with the toxicological properties of the contaminants to estimate (inferentially) the potential public health impacts posed by constituents detected at the site.

The BRA for the site was conducted in accordance with current USEPA Risk Assessment Guidance (USEPA, 1989 and USEPA, 1991), and USEPA Region IV Supplemental Risk Guidance (USEPA, 1992d).

The components of the BRA include the following:

- Hazard Identification: determination as to whether a substance has the potential to elicit an adverse effect (toxicity) upon exposure to humans
- Exposure Assessment: identification of the human population(s) likely to be exposed and the development of specific exposure pathways for the population
- Toxicity Assessment: quantification of the relationship between the human exposure and the probability of occurrence (risk) of a toxic response
- Risk Characterization: development of a quantitative estimation of the potential risk from a combination of information collected during the exposure and toxicity assessment
- Uncertainty Analysis: identification and qualitative discussion of any major sources of uncertainty pertaining to the finding of the BRA
- Conclusions: summarization and conclusion of the results of the BRA relating to the total site risk are drawn

Each of these components of the BRA is discussed and addressed for the site in the following subsections. Introductory text is presented first, followed by a site-specific discussion. Referenced tables and figures are presented after the text portion of this section.

6.2 Hazard Identification

Data generated during the remedial investigation and previous studies at the site were used to draw conclusions and to identify data gaps in the BRA. The data were evaluated to assess which data were of sufficient quality to include in the risk assessment. The objective when selecting data to include in the risk assessment was to provide accurate and precise data to characterize contamination and evaluate exposure pathways.

6.2.1 Data Evaluation and Reduction

The initial hazard identification step entailed the validation and evaluation of the site data to determine its usability in the risk assessment. Validation was conducted by an independent third party (Heartland Environmental Services, Inc.). Validation of the analytical data is included to verify that proper quality assurance/quality control (QA/QC) was performed and that the corresponding

were within the specified method control limits. This process resulted in the identification of COPCs for the site. During this validation and evaluation, data that would result in inaccurate conclusions (e.g., data that were rejected or attributed to blank contamination, as qualified by the validator) were reduced within the data set. Data reduction entailed the removal of unreliable data from the original data set based on the guidelines established by USEPA. A summary of the data quality was presented in Section 4.1, Data Quality.

6.2.2 Identification of Data Suitable for Use in a Quantitative Risk Assessment

To provide for accurate conclusions to be drawn from sampling results, analytical data were reviewed and evaluated. During this review and evaluation, data that would lead to inaccurate conclusions were reduced within each data set. This section presents the criteria that were used to review, reduce, and summarize the analytical data. These criteria are consistent with USEPA guidance for data reduction.

Three environmental media were investigated at Site 54 during this RI: surface soils, subsurface soils, and shallow groundwater. There were no surface water bodies of either human health and/or ecological significance present at this site. That is, surface water and sediment samples were not collected from any of the runoff ditches because they were either dry (in which case soil samples were collected) or they also were receiving run-off from areas not related to Site 54. The two surficial aquifers were investigated at this site. The surface soil and subsurface soil data were evaluated as single data sets. That is, the data were not segregated into areas of concern. Surface soil samples were collected from 0- to 12-inches, and subsurface from greater than 12-inches below ground surface. The shallow aquifer was evaluated as a single unit. For Site 54, these media were assessed for potential risk to human receptors. Section 2.0 of this report provides details on the Site Setting.

Data collected during the March to April, 1995, sampling event was evaluated in this risk assessment. The previous investigations conducted at this site are detailed in Section 1.0 of this report.

Information relating to the nature and extent of contamination at the site is provided in Section 4.0 of this report. The discussion provided in Section 4.0 also was utilized in the selection of COPCs at the site. The reduced data sets for all media of concern at the site are provided in Appendices G and H of this report.

6.2.3 Criteria Used in Selection of COPCs

This section presents the criteria used in the selection of COPCs for the evaluation of potential human health risk. As exemplified by the data summary tables in Appendices G and H, the number of constituents positively detected at least once during the field investigation is large. Quantifying risk for all positively identified parameters may distract from the dominant risks presented by the site. Therefore, the data set (resulting data set after applying the criteria listed in the previous section) was reduced to a list of COPCs. As stated previously, COPCs are site-related contaminants used to quantitatively estimate human exposures and associated potential health effects.

The selection of the COPCs was based on a combination of detected concentrations; toxicity; frequency of detection; comparison to background values, including site-specific, base-specific and published ranges; and comparison of physiochemical properties, including mobility, persistence, and

toxicity. In addition, historical information pertaining to past site activities was considered. USEPA guidance states that a contaminant may not be retained for quantitative evaluation in the BRA if: (1) it is detected infrequently in an environmental medium (e.g., equal to or less than 5 percent for at least 20 samples per data set), (2) it is absent or detected at low concentrations in other media, or (3) site history does not provide evidence the contaminant to be present (USEPA, 1989). To qualitatively assess the COPCs, comparisons of results to federal and state criteria and Region III Risk-Based Concentrations (RBCs) (USEPA, 1995b) were used. A brief description of the selection criteria used in choosing final COPCs is presented below (Section 6.2.3.6). A contaminant did not need to meet the criteria of all of these three categories in order to be retained as a COPC.

6.2.3.1 Site Setting

The Crash Crew Fire Training Burn Pit (Site 54) is located near the southwest end of runway 6-23, within the operations area of MCAS, New River. The burn pit is approximately 50 feet in diameter and is situated at the center of this 1.5 acre site. An 8,000-gallon underground storage tank (UST) lies to the west of the burn pit. Fire training exercises are conducted within the burn pit using JP-type fuel, which is stored in the nearby UST. An oil and water separator, located approximately 100 feet to the southeast of the burn pit, is used for temporary storage and collection of the spent fuel.

An improved gravel surface surrounds the burn pit; the remaining portion of the site is comprised of maintained lawn area. The ground surface slopes away from the central portion of the study area toward the south, southwest, and southeast. Two drainage ditches lead away from the burn pit area toward the south, on either side of an improved road. During periods of heavy precipitation, the ditches serve as channels for surface water runoff.

Site History

Site 54 has served as a fire training burn pit since the mid-1950s. Waste fuels, oils, and solvents were used to simulate fire conditions that would result from aircraft crashes. Fire training at Site 54 was originally conducted on the ground surface, within a bermed area. In 1975 a lined burn pit was constructed (WAR, 1983). The same burn pit remains in operation today; however, only JP-type fuels are currently used during training exercises.

The site media (i.e., soil, groundwater, surface water, and sediment) were previously investigated by WAR in 1983, and by ESE in 1986 and 1987. POL contamination was noted in the soil at depth. The 1984 groundwater results indicated levels of chromium, oil and grease, and phenols. In later studies, these same parameters were detected in the groundwater; however, no VOCs were detected. Total phenols were found in surface water. Chromium, lead, oil and grease, and total phenols were detected in sediment.

During a recent site visit conducted in March, 1994, fuel odor and a sheen on the water in the burn pit were noted. An area of ground cover stressed was identified southwest of the burn pit. Broken glass and metal debris were scattered on the ground along Perimeter Road.

The most recent sampling event investigated these same site media. A preliminary assessment of the unvalidated laboratory results indicates PAHs in the soil and VOCs, including benzene, toluene, ethylbenzene, xylenes (BTEX), and 1,2-DCE, in the groundwater.

6.2.3.2 Frequency of Detection

In general, constituents that were detected infrequently (e.g., equal to or less than 5 percent, when at least 20 samples of a medium are available) may be anomalies due to sampling or analytical errors or may be present simply in the environment due to past or current site activities. It should be noted, however, that detected constituents were individually evaluated prior to exclusion from the BRA. Physiochemical properties (i.e., fate and transport) and toxicological properties for each detected constituent were evaluated (see following sections).

6.2.3.3 Comparison to Background

Sample concentrations were compared to site-specific (i.e., twice the base-specific average concentration) background levels. Background information was available for all media of concern at the site, excluding groundwater. The results of these comparisons are presented in Tables 6-1 through 6-3.

6.2.3.4 Physiochemical Properties

Mobility

The physical and chemical properties of a contaminant are responsible for its transport in the environment. These properties, in conjunction with site conditions, determine whether a contaminant will tend to volatilize into the air from surface soils or surface waters or be transported via advection or diffusion through soils, groundwaters, and surface waters. Physical and chemical properties also describe a contaminant's tendency to adsorb onto soil/sediment particles. Environmental mobility can correspond to either an increased or decreased potential to affect human health and/or the environment.

Persistence

The persistence of a contaminant in the environment depends on factors such as the microbial content of soil and water, organic carbon content, the concentration of the contaminant, climate, and the ability of the microbes to degrade the contaminant under site conditions. In addition, chemical degradation (i.e., hydrolysis), photochemical degradation, and certain fate processes such as sorption may contribute to the elimination or retention of a particular compound in a given medium.

6.2.3.5 Toxicity

The potential toxicity of a contaminant is an important consideration when selecting COPCs for further evaluation in the human health assessment. For example the weight-of-evidence (WOE) classification should be considered in conjunction with concentrations detected at the site. Some effects considered in the selection of COPCs include carcinogenicity, mutagenicity, teratogenicity, systemic effects, and reproductive toxicity. Bioaccumulation and bioconcentration properties may affect the severity of the toxic response in an organism and/or subsequent receptors and are evaluated if relevant data exist.

Despite their inherent toxicity, certain inorganic contaminants are essential nutrients. Essential nutrients need not be considered for further consideration in the quantitative risk assessment if they are present in relatively low concentrations (i.e., below twice the average base-specific background

levels or slightly elevated above naturally occurring levels) or if the contaminant is toxic at doses much higher than those which could be assimilated through exposures at the site. Due to the difficulty of determining nutrient levels that were within acceptable dietary levels, only essential nutrients present at low concentrations (i.e., only slightly elevated above background) were eliminated from the BRA. Essential nutrients, however, were included in the ecological risk evaluation.

6.2.3.6 Contaminant Concentrations in Blanks

Sample concentrations were compared quantitatively to investigation-related blank concentrations. Sample concentrations of parameters that are typical laboratory or field contaminants (i.e., acetone, 2-butanone, methylene chloride, toluene, and phthalate esters) that exceeded blank concentrations by a factor of 10 and other parameter concentrations that exceeded blank concentrations by a factor of five were considered to be site related. Parameters not meeting this criteria were considered artifacts from field or laboratory practices and treated as non-detects.

For Site 54, the following organics were found in the blanks: acetone (20 µg/L), carbon disulfide (5 µg/L), chloroform (5 µg/L), 2-butanone (32 µg/L), naphthalene (1 µg/L), and bis(2-ethylhexyl)phthalate (280 µg/L).

6.2.3.7 Federal and State Criteria and Standards

Contaminants detected at the site were compared to state and federal standards, criteria, and/or To Be Considered levels (TBCs). These comparisons may provide some qualitative information as to the relative potential for health impacts resulting from the site. It should be noted that COPC concentration ranges were directly compared to each standard/criteria/TBC. This comparison did not take into account the additive or synergistic effects of those constituents without standards or criteria. Consequently, conclusions regarding potential risk posed by each site cannot be inferred from this comparison. A brief explanation of the standards/criteria/TBCs used for the evaluation of COPCs is presented below.

North Carolina Water Quality Standards (NCWQSs) - Groundwater - NCWQSs are the maximum allowable concentrations resulting from any discharge of contaminants to the land or waters of the state, which may be tolerated without creating a threat to human health or which otherwise render the groundwater unsuitable for its intended purpose.

Maximum Contaminant Levels (MCLs) - Federal Groundwater Standards - 40 CFR 161 - MCLs are enforceable standards for public water supplies promulgated under the Safe Drinking Water Act and are designed for the protection of human health. MCLs are based on laboratory or epidemiological studies and apply to drinking water supplies consumed by a minimum of 25 persons. They are designed for prevention of human health effects associated with a lifetime exposure (70-year lifetime) of an average adult (70 kg) consuming 2 liters of water per day. MCLs also consider the technical feasibility of removing the contaminant from the public water supply.

Health Advisories (HAs) - HAs are guidelines developed by the USEPA Office of Drinking Water for nonregulated constituents in drinking water. These guidelines are designed to consider both acute and chronic toxic effects in children (assumed body weight 10 kg) who consume 1 liter of water per day or in adults (assumed body weight 70 kg) who consume 2 liters of water per day. HAs are generally available for acute (1 day), subchronic (10 days), and chronic (longer-term) exposure

scenarios. These guidelines are designed to consider only threshold effects and, as such, are not used to set acceptable levels of potential human carcinogens.

USEPA Region III COC Screening Values - COC screening values are derived using conservative USEPA promulgated default values and the most recent toxicological criteria available. COC screening values for potentially carcinogenic and noncarcinogenic chemicals are individually derived based on a target incremental lifetime cancer risk (ILCR) of 1×10^{-6} and a target hazard quotient of 0.1, respectively. For potential carcinogens, the toxicity criteria applicable to the derivation of COC screening values are oral and inhalation cancer slope factors; for non carcinogens, they are chronic oral and inhalation reference doses. These toxicity criteria are subject to change as more updated information and results from the most recent toxicological/epidemiological studies become available. Therefore, the use of toxicity criteria in the derivation of COC screening values requires that the screening concentrations be updated periodically to reflect changes in the toxicity criteria.

Since the most recent COC screening values table was issued by USEPA in October 1995, the values from these tables can be updated by incorporating information from another set of tables containing risk-based concentrations (RBCs) that are issued by USEPA Region III on a quarterly basis. The RBCs are derived using the same equations and USEPA promulgated default exposure assumptions that were used by Region III to derive the COC screening values. In addition, the quarterly RBCs for potentially carcinogenic chemicals are based on a target ILCR of 1×10^{-6} . The only difference in the derivation methodologies for the COC screening values and the RBCs is that the RBCs for noncarcinogens are based on a target hazard quotient of 1.0 rather than 0.1. The COC screening values for noncarcinogens are to be derived based on a target hazard quotient of 0.1, to account for cumulative risk from multiple chemicals in a medium. Re-derivation of the quarterly noncarcinogenic RBCs based on a target hazard quotient of 0.1, while using the most recent toxicological criteria available, results in a set of values that can be used, as a COC screening values. In other words, an updated set of COC screening values can be attained each quarter by using the carcinogenic RBCs issued quarterly by USEPA Region III and dividing the accompanying noncarcinogenic RBCs by a factor of 10.

North Carolina Water Quality Standards (Surface Water) - The NCWQSs for surface water are the standard concentrations that, either alone or in conjunction with other wastes in surface waters, will neither render waters injurious to aquatic life, wildlife, or public health, nor impair the waters for any designated use.

Ambient Water Quality Criteria - AWQCs are non-enforceable regulatory guidelines and are of primary utility in assessing acute and chronic toxic effects in aquatic systems. They may also be used for identifying the potential for human health risks. AWQCs consider acute and chronic effects in both freshwater and saltwater aquatic life, and potential carcinogenic and noncarcinogenic health effects in humans from ingestion of both water (2 liters/day) and aquatic organisms (6.5 grams/day), or from ingestion of water alone (2 liters/day). The human health AWQCs for potential carcinogenic substances are based on the USEPA's specified incremental cancer risk range of one additional case of cancer in an exposed population of 10,000,000 to 100,000 (i.e. the 10^{-7} to 10^{-5} range).

Sediment Screening Levels - Sediment Screening Levels (SSLs) have been compiled to evaluate the potential for contaminants in sediments to cause adverse health effects (Long, et.al, 1995; Long and Morgan 1991; and, USEPA, 1995b). The lower ten percentile (Effects Range-Low [ER-L]) and the median percentile (Effects Range-Median [ER-M]) of biological effects have been developed

for several contaminants. The concentration below the ER-L represents a minimal-effects range (adverse effects would be rarely observed). The concentration above the ER-L but below the ER-M represents a possible-effects range (adverse effects would occasionally occur). Finally, the concentration above the ER-M represents a probable-effects range (adverse effects would probably occur).

As stated previously, COPCs in all media of concern at the site were compared with these aforementioned criteria. The results of the standards/criteria/TBC comparison for the site are presented in Tables 7-1 through 6-3. The results are discussed in Section 6.5.

6.2.4 Contaminants of Potential Concern (COPCs)

The following sections present an overview of the analytical data obtained for each medium and the subsequent retention or elimination of COPCs using the aforementioned criteria for selection of COPCs.

6.2.4.1 Surface Soil

In surface soil, arsenic was identified as a COPC. It was detected frequently in every sample, and the maximum concentration exceeded the residential soil screening level. However, this concentration was detected below the base-specific background level. These results are summarized in Table 6-1.

No VOCs were detected in the surface soil of this site. As a result, no VOCs were identified as COPCs.

Seven SVOCs were detected in the 11 surface soil samples analyzed for these parameters. On comparison to Region III residential soil screening levels, the following SVOCs were detected at maximum levels below the residential soil levels: n-nitrosodiphenylamine, phenanthrene, fluoranthene, pyrene, butylbenzylphthalate, bis(2-ethylhexyl)phthalate, and di-n-octylphthalate. There is no RBC for phenanthrene. As a result, the RBC for pyrene was substituted. Consequently, no SVOCs were selected as COPCs in surface soil.

Fifteen metals were detected in the four surface samples analyzed for inorganics. Aluminum, barium, chromium, cobalt, copper, lead, manganese, vanadium, and zinc were detected at levels less than the screening levels and were not retained as COPCs in surface soil. The maximum concentration of iron was less than the base-specific background level. Consequently, iron was not selected as a COPC. Essential nutrients also were excluded. In surface soil, these chemicals included calcium, magnesium, potassium, and sodium. As a result, only arsenic was identified as COPC in surface soil.

6.2.4.2 Subsurface Soil

In subsurface soil, the COPCs were identified as the following: aluminum and arsenic. These COPCs were detected frequently (i.e., 100 percent and 13 percent, respectively) and exceeded residential soil screening levels. These results are presented in Table 6-2.

Two VOCs were detected in the 19 samples analyzed for these parameters. Acetone was detected at a frequency of 5 percent and at a maximum concentration less than the screening level. Xylene

also did not exceed its screening level. As a result, both VOCs were not retained as COPCs in subsurface soil.

Eight SVOCs were detected in the 19 samples analyzed for SVOCs. The following SVOCs were detected infrequently (i.e., equal to 5 percent): naphthalene, 2-methylnaphthalene, acenaphthene, fluorene, phenanthrene, pyrene, butylbenzylphthalate, and bis(2-ethylhexyl)phthalate. The maximum concentrations of these contaminants were also significantly less than the residential soil screening levels. As a result, no SVOCs were selected as COPCs in subsurface soil.

Sixteen metals were detected in the eight samples analyzed for inorganics. As stated previously, aluminum and arsenic were retained as COPCs. The maximum concentrations of the following contaminants did not exceed Region III residential soil screening levels: barium, chromium, cobalt, copper, lead, manganese, nickel, vanadium, and zinc. Consequently, they were not included as COPCs.

Iron was detected at a maximum concentration below the base-specific background level. As a result, it was not included as a COPC. Essential nutrients were excluded. In subsurface soil, these chemicals included calcium, magnesium, potassium, and sodium.

6.2.4.3 Shallow Groundwater

In the shallow groundwater, the COPCs were identified as the following (detection frequencies are noted): 1,2-dichloroethene (total) (18 percent), benzene (35 percent), toluene (12 percent), nitrobenzene (6 percent), naphthalene (41 percent), 2-methylnaphthalene (35 percent), aluminum (23 percent), arsenic (31 percent), iron (92 percent), lead (38 percent), and manganese (100 percent). These COPCs were detected frequently and exceeded Region III tap water screening levels. Table 6-3 presents these results.

Seven VOCs were detected in the 17 samples analyzed for these parameters. Three VOCs, 1,2-dichloroethene (total), benzene, and toluene, were identified as COPCs in groundwater. On comparison of the maximum concentrations of the carbon disulfide, trichloroethene, ethylbenzene, and xylene (total) to the Region III tap water screening levels, they did not exceed the screening levels. Consequently, the remaining four VOCs were not included in the evaluation.

Of the 17 samples analyzed for SVOCs, nine SVOCs were detected. Nitrobenzene, naphthalene, and 2-methylnaphthalene were selected as COPCs in groundwater. On comparison of the maximum concentrations of the following contaminants to the Region III tap water screening levels, they did not exceed the screening levels: phenol, 2,4-dimethylphenol, diethylphthalate, anthracene, di-n-butylphthalate, and bis(2-ethylhexyl)phthalate. As a result, these contaminants were excluded from evaluation as COPCs.

Fourteen metals were detected in the 13 samples analyzed for inorganics. Aluminum, arsenic, iron, lead, and manganese were retained as COPCs. Barium, chromium, cobalt, nickel, and zinc were detected at levels less than screening values and excluded from evaluation. Essential nutrients were also excluded. These constituents include calcium, magnesium, potassium, and sodium.

6.3 Exposure Assessment

The exposure assessment addresses each potential exposure pathway via soil (surface and subsurface), groundwater, surface water, sediment, biota, and air. To determine if human exposure via these pathways may occur in the absence of remedial action, an analysis including the identification and characterization of exposure pathways was conducted. The following four elements were examined to determine if a complete exposure pathway was present:

- 1) a source and mechanism of chemical release
- 2) an environmental transport medium
- 3) a feasible receptor exposure route
- 4) a receptor exposure point

The exposure scenarios presented in the following sections are used to estimate individual risks. Unless otherwise noted, all the statistical data associated with the factors used in the dose evaluation equations for assessing exposure were obtained from the Exposure Factors Handbook (USEPA, 1989a) and the accompanying guidance manuals. A reasonable maximum exposure (RME) scenario was utilized in this assessment, which is consistent with USEPA Region IV recommendations regarding human health risk assessment. As a result, the exposure scenarios presented include RME assumptions for the input parameters in the dose evaluation equations. These values are summarized in Table 6-4.

6.3.1 Potential Human Receptors and Adjacent Populations

The following sections provide a discussion of the potential exposure pathways and receptors at Site 54.

6.3.1.1 Site Conceptual Model for Site 54

A site conceptual model of potential sources, migration pathways and human receptors was developed to encompass all current and future potential routes of exposure at the site. This document is presented in Appendix S. Figure 6-1 presents the potential exposure pathways and receptors for Site 54. Qualitative descriptions of current and future land use patterns in the vicinity of OU No.6 were provided in the model. All available analytical data and meteorological data were considered in addition to general understanding of the demographics of surrounding communities.

From this information, the following general list of potential receptors was developed for inclusion in the quantitative health risk analysis for Site 54:

- Current military personnel
- Current trespassers (child [age 1-6 years] and adult)
- Future on-site residents (child [age 1-6 years] and adult)
- Future construction worker

The following sections present a discussion of the potential exposure pathways and receptors at Site 54.

6.3.1.2 Current and Future Scenarios

Site 54 is currently used for emergency fire response training. Current receptors include on-site military personnel and trespassers (i.e., child and adult receptors). Access to the site is not limited. Consequently, trespassing may occur onto the site. Exposure pathways for these receptors include surface soil incidental ingestion, dermal contact, and inhalation of fugitive dust.

At present, shallow groundwater is not utilized for potable purposes. As a result, current shallow groundwater exposure was not assessed. Exposure to subsurface soil in the current scenario is unlikely for the receptor population. Consequently, subsurface soil is not considered to be a viable medium for exposure.

In the future case, it is unlikely that a residential development will be implemented at the site. It is assumed that the present activities will continue into the foreseeable future. However, in a conservative measure, groundwater exposure to a residential child and adult receptor was assessed. Surface soil exposure, as calculated in the current scenario for the child and adult trespassers, is expected to remain the same in the future case.

Groundwater exposure for future on-site military personnel was not assessed, for the same reasons it was not evaluated for the other sites. However, a construction worker was evaluated in the future case. It is assumed that surface and subsurface soil exposure may occur as a result of excavation for potential construction activities at the site. In addition, exposure to excavated subsurface soil was assessed for future residents (i.e., child and adult receptor). The exposure pathways for these receptors are incidental ingestion, dermal contact, and inhalation.

6.3.2 Exposure Pathways

In general, the migration of COPCs from site soil sources could potentially occur by the following routes:

- Vertical migration of potential contaminants from surficial soils to subsurface soils.
- Leaching of potential contaminants from subsurface soils to the water-bearing zones.
- Vertical migration from shallow water-bearing zones to deeper flow systems.
- Horizontal migration in groundwater in the direction of groundwater flow.
- Wind erosion and subsequent deposition of windblown dust.

The potential for a constituent to migrate spatially and persist in environmental media is important in the estimation of potential exposure. This section describes the potential exposure pathways presented on Figure 6-1 associated with each medium and each potential human receptor group, then qualitatively evaluates each pathway for further consideration in the quantitative risk analysis. Table 6-5 presents the potential human exposure scenarios for this site.

6.3.2.1 Surface Soil

The potential release source considered in the soil pathway was the chemical residuals in the surface soils. The release mechanisms considered were volatilization, fugitive dust generation/deposition, leaching, and surface runoff. The transport media were the surface soils and air. The routes for

human exposure to the contaminated soils included inhalation, ingestion, and dermal contact. Potential exposure points from the site were areas of human activity on and adjacent to the site.

Soil Ingestion and Dermal Contact

Incidental ingestion and dermal contact with surface soil in the current case are complete exposure pathways at Site 54. These exposure pathways were evaluated for the current military receptor and trespassers.

Soil Inhalation Via Volatilization

The soil represents a potential source of exposure at the site via volatilization of COPCs. The potentially exposed population includes current military personnel who may inhale contaminated air. However, no VOCs were identified as COPCs in either media at the site. No air was sampled at this site. This pathway is not considered to be significant for the site and was not evaluated for the surface soils.

Soil Inhalation Via Fugitive Dust Generation

The surface soils in the current case and the subsurface soils in the future case represent a potential source of exposure at the site via fugitive dust generation from wind erosion and vehicular traffic on surface soils. Current military personnel, trespassers, and construction workers may inadvertently inhale the contaminated particulates as dust while engaging in outdoor activities.

6.3.2.2 Subsurface Soil

The potential release source considered in the subsurface soil pathway was the chemical residuals in the contaminated soils. The release mechanism considered was leaching to groundwater. The transport medium was the groundwater infiltrating the subsurface soil. Therefore, exposure to subsurface soils would be indirect (i.e., leaching of contaminants to groundwater). As such, subsurface soil exposure was addressed in the groundwater pathway analysis. Additionally, subsurface soil exposure was mentioned as part of the soil medium. It was assumed that the subsurface soil would be excavated and used as surface grading, landscaping, etc., in the foreseeable future. As a result, exposure to subsurface soil via ingestion, dermal contact, and inhalation was evaluated for the future construction worker and child and adult receptor. It was assumed that this exposure would result from outdoor activities.

6.3.2.3 Groundwater

The potential release source considered in evaluating the groundwater pathway was contaminated soils. The release mechanism considered was soil leaching. The transport medium was the groundwater. The routes considered for human exposure to the groundwater were direct ingestion of groundwater, dermal contact during showering, and inhalation of volatilized contaminants during showering.

Residences located on-site in the future scenario were considered to be potential exposure points. At present, on-site groundwater is not potable. As a result, groundwater from on-site sources is not significant and was not evaluated for potential risk in the current scenario. In the future scenario, it is conservatively assumed that a potable well will be installed on-site. However, as stated

previously, it is not expected that this residential scenario will be implemented in the future at these military sites. As a result, future groundwater risks on-site were assessed conservatively in accordance with guidance.

6.3.2.4 Surface Water

There were no surface water bodies identified at this site. As a result, this medium was not evaluated.

6.3.2.5 Sediment

There were no surface water bodies identified at this site. As a result, this medium was not evaluated.

6.3.2.6 Air

There are two potential release mechanisms to be considered in evaluating the atmospheric pathway: release of contaminated particulates (i.e., fugitive dust generation) and volatilization of contaminants from soil and groundwater. The transport mechanism is the air, and the potential exposure points are the areas of human activity on and adjacent to the site.

Fugitive Dust Generation

This air pathway was evaluated as a source of exposure outdoors at the site via fugitive dust generation of contaminants. Air exposure may occur when surface soils become airborne due to wind erosion or vehicular traffic. It is assumed that military personnel, child and adult receptors, and construction workers may inhale soil particulates while engaging in outdoor activities. This is applicable for both the current and future cases. This exposure pathway was previously discussed for surface and subsurface soil in Sections 6.3.2.1 and 6.3.2.2, respectively.

Volatilization

The air pathway, specifically, volatilization of contaminants from groundwater, is a source of exposure at Site 54. It is assumed in the future scenario that an adult and child receptor will inhale volatilized contaminants present in groundwater while showering. This pathway was previously discussed for groundwater, as well as surface soil, in Sections 6.3.2.3 and 6.3.2.1, respectively.

6.3.2.7 Aquatic Biota

There were no surface water bodies identified at this site. As a result, this medium was not evaluated.

6.3.3 **Quantification of Exposure**

The concentrations used in the estimation of chronic daily intakes (CDIs) must be representative of the type of exposure being considered. Exposure to groundwater can occur discretely or at a number of sampling locations. This medium is transitory in that concentrations change frequently over time. Averaging transitory data obtained from multiple locations is difficult and requires many more data points at discrete locations than exist within this site. As a result, the best way to represent

groundwater constituents from an exposure standpoint is to use a representative exposure concentration. Soils are less transitory than the aforementioned media and in most cases, exposure occurs over a wider area (i.e., residential exposure). Therefore, an upper confidence interval was used to represent a soil exposure concentration. Soil data collected from each of these areas was used separately in estimating the potential human health risks under current and future exposure scenarios. The human health assessment for future groundwater use considered groundwater data collected from all of the monitoring wells within a site and estimated risks to individuals per area of concern.

The manner in which environmental data are represented depends on the number of samples and sampling locations available for a given area and a given medium. Ninety-fifth percent (95%) upper confidence limit (UCL) values of the arithmetic mean for a lognormal distribution were used as exposure point concentrations for surface, subsurface soil, groundwater, surface water, and sediment. The 95 percent UCL for the lognormal distribution, rather than the normal distribution, since the former is generally more conservative than the latter, was used for each contaminant in a given data set for quantifying potential exposure. For exposure areas with limited amounts of data or extreme variability in measured data, the 95 percent UCL can be greater than the maximum measured concentration; therefore, in cases where the 95 percent UCL for a contaminant exceeds the maximum detected value in a given data set, the maximum result was used in the estimate of exposure of the 95 percent UCL. However, the true mean may still be higher than this maximum value (i.e., the 95 percent UCL indicates a higher mean is possible), especially if the most contaminated portion of the site has not been sampled.

The 95 percent UCL of the lognormal distribution was calculated using the following equation (USEPA, 1992b):

$$UCL = e^{(\bar{x} + sH/\sqrt{n-1})}$$

Where:

UCL	=	upper confidence limit
e	=	constant (base of the natural log, equal to 2.718)
x	=	mean of the transformed data
s	=	standard deviation of the transformed data
H	=	H-statistic
n	=	number of samples

The following criteria were used to calculate media-specific average concentrations for each parameter that was detected at least once:

- For results reported as "non-detect" (e.g., ND, U, etc.), a value of one-half of the sample-specific detection limit was used to calculate the mean. The use of one-half the detection limit commonly is assigned to non-detects when averaging data for risk assessment purposes, since the actual value could be between zero and a value just below the detection limit.
- Reported concentrations that were less than the detection limit were used to calculate the mean. Typically, these values are qualified with a "J" meaning that the value was estimated.

- The organic analytical results qualified with a "B" were not retained in the data set. The "B" qualifier means that the detected concentration was less than either five times or ten times the blank concentration (i.e., the 5-10 rule), depending upon the parameter. Common laboratory contaminants, such as phthalate esters, toluene, methylene chloride, methyl ethyl ketone, and acetone, follow the five times rule, while all other parameters follow the ten times rule (USEPA, 1989).
- Reported concentrations qualified with "R" were excluded from the data set. The data flag "R" means that the QA/QC data indicated that analytical results were not usable for quantitative purposes.

The reduced data were summarized by medium and analytical parameter type (i.e., organics and inorganics) for the site. For each parameter detected during the sampling programs, the frequency of detection, maximum concentration, minimum concentration, average (arithmetic mean) concentration, and both the normal and lognormal upper 95 percent level for the arithmetic average were summarized. This information is presented in Appendix H. It should be noted that the number of times analyzed may differ per parameter per media per area of concern. This is primarily due to data rejected due to QA/QC problems and excluded from the data set. Consequently, these data are not reflected in the number of times analyzed. Data and frequency summaries and statistical summaries are presented in Appendices G and H, respectively.

To estimate exposure from the inhalation of volatile contaminants in groundwater while showering, the "Integrated Household Exposure Model for Use of Tap Water Contaminated with Volatile Organic Chemicals," developed by S.A. Foster and P.C. Chrostowski (1987), was applied. To evaluate the health effects of lead, the USEPA lead uptake/biokinetic model was used. The model addresses the lowest age groups because children are exceptionally sensitive to the adverse effects of lead. These models are presented in Appendices Q and R.

6.3.4 Calculation of Chronic Daily Intakes

In order to numerically estimate the risks for current and future human receptors at Site 54, a CDI must be estimated for each COPC in every retained exposure pathway. Appendix T contains the specific CDI equations for each exposure scenario of interest. These equations were obtained from USEPA guidance (USEPA, 1989).

The following paragraphs present the general equations and input parameters used in the calculation of CDIs for each potential exposure pathway. Input parameters were taken from USEPA's default exposure factors guidelines where available and applicable. All inputs not defined by USEPA were derived from USEPA documents concerning exposure or from best professional judgment. All exposure assessments incorporate the representative contaminant concentrations in the estimation of intakes. Therefore, only one exposure scenario was developed for each exposure route/receptor combination.

CDIs for carcinogenic effects incorporate terms to represent the exposure duration (years) over the course of a lifetime (70 years, or 25,550 days). Noncarcinogenic CDI, on the other hand, were estimated using the concept of an average annual exposure. The intake incorporates terms describing the exposure time and/or frequency representing the number of hours per day and the number of days per year that exposure occurs. In general, noncarcinogenic CDIs for many exposure

routes (e.g., soil ingestion) are greater for children than adults because of the differences in body weights, similar exposure frequencies, and higher ingestion rates.

Future residential exposure scenarios consider 1 to 6 year old children weighing 15 kg and adults weighing 70 kg on average. For current military personnel, an exposure duration of 4 years was used to estimate a military residence. A one-year duration was used for future construction worker exposure scenarios (USEPA, 1989).

6.3.4.1 Incidental Ingestion of Soil

The CDI for COPCs detected in soil was estimated for all potential human receptors and was expressed as:

$$CDI = \frac{C \times IR \times CF \times Fi \times EF \times ED}{BW \times AT}$$

Where:

C	=	Contaminant concentration in soil (mg/kg)
IR	=	Ingestion rate (mg/day)
CF	=	Conversion factor (1×10^{-6} kg/mg)
Fi	=	Fraction ingested from source (dimensionless)
EF	=	Exposure frequency (days/year)
ED	=	Exposure duration (years)
BW	=	Body weight (kg)
AT	=	Averaging time (days)

The following paragraphs discuss the exposure assumptions used in the estimation of exposure to COPCs associated with the potential ingestion of soils.

Military Personnel

During the course of daily activities at Site 54, military personnel could potentially be exposed to COPCs by the incidental ingestion of surface soils. The IR for military personnel exposed to surficial soils was assumed to be 100 mg/day (USEPA, 1989), and the fraction ingested was assumed to be 100 percent. An exposure frequency (EF) of 250 days per year was used in conjunction with an exposure duration of 4 years (USEPA, 1991). An averaging time (AT) of 70 years or 25,550 days was used for exposure to potentially carcinogenic compounds while an averaging time of 1,460 (4 years x 365 days/year) days was used for noncarcinogenic exposures. An adult average body weight (BW) of 70 kg was used (USEPA, 1989).

Trespassers

Trespassers could potentially be exposed to COPCs in the surficial soils. Children and adults could potentially be exposed to COPCs in soils by incidental ingestion via hand to mouth contact. Ingestion rates (IR) for adults and children in this scenario were assumed to be 100 mg/day and 200 mg/day, respectively. EFs for both receptor groups were assumed to be 130 days per year (child) and 43 days/year (adult) (USEPA, 1992). The residential exposure duration (ED) was divided into two parts. First, a six-year exposure duration was evaluated for young children which accounts for the period of highest soil ingestion (200 mg/day), and second a 30-year exposure was

assessed for older children and adults by using a lower soil ingestion rate (100 mg/day) (USEPA, 1991). Averaging times of 25,550 days for potential carcinogens and 10,950 days (30 years x 365 days/year) for noncarcinogenic constituents was used for estimating potential CDIs for adults. An AT of 2,190 days (6 years x 365 days/year) was used to estimate potential CDIs for children potentially exposed to noncarcinogens.

Future On-Site Residents

Future on-site residents could potentially be exposed to COPCs in the surficial soils during recreational or landscaping activities around their homes. Children and adults could potentially be exposed to COPCs in soils by incidental ingestion via hand to mouth contact. Ingestion rates (IR) for adults and children in this scenario were assumed to be 100 mg/day and 200 mg/day, respectively. EFs for both receptor groups were assumed to be 350 days per year (USEPA, 1991). The residential exposure duration (ED) was divided into two parts. First, a six-year exposure duration was evaluated for young children which accounts for the period of highest soil ingestion (200 mg/day), and second a 30-year exposure was assessed for older children and adults by using a lower soil ingestion rate (100 mg/day) (USEPA, 1991). Averaging times of 25,550 days for potential carcinogens and 10,950 days (30 years x 365 days/year) for noncarcinogenic constituents was used for estimating potential CDIs for adults. An AT of 2,190 days (6 years x 365 days/year) was used to estimate potential CDIs for children potentially exposed to noncarcinogens.

Future Construction Worker

During excavation activities, construction workers may be exposed to COPCs through the incidental ingestion of subsurface soil. The IR for future construction workers exposed to subsurface soils was assumed to be 480 mg/day (USEPA, 1991). An exposure frequency of 90 days per year was used in conjunction with an exposure duration of one year (USEPA, 1991). An adult BW of 70 kg was used.

A summary of the exposure factors used in the estimation of soil CDIs associated with incidental ingestion is presented in Table 6-4.

6.3.4.2 Dermal Contact with Soil

Chronic daily intakes associated with potential dermal contact of soils containing COPCs were expressed using the following equation:

$$CDI = \frac{C \times CF \times SA \times AF \times ABS \times EF \times ED}{BW \times AT}$$

Where:

- C = Contaminant concentration in soil (mg/kg)
- CF = Conversion factor (kg/mg)
- SA = Skin surface available for contact (cm²)
- AF = Soil to skin adherence factor (1.0 mg/cm²)
- ABS = Absorption factor (dimensionless) - 0.01 for organics, 0.001 inorganics (USEPA, Region IV, 1992a and 1992d)
- EF = Exposure frequency (days/year)
- ED = Exposure duration (years)

BW = Body weight (kg)
AT = Averaging time (days)

The following paragraphs discuss the exposure assumptions used in the estimation of exposure to COPCs from dermal contact with soils.

Military Personnel

There is a potential for base personnel to absorb COPCs by dermal contact. The exposed skin surface area (4,300 cm²) was limited to the head (1,180 cm²), arms (2,280 cm²), and hands (840 cm²) (USEPA, 1992). Values for exposure duration (ED), exposure frequency (EF), body weight (BW), and averaging time (AT) were the same as those used for the incidental ingestion of soil scenario. The values for AF and ABS were provided above and are in accordance with USEPA and Region IV guidance.

Trespassers

Trespassers could also be potentially exposed to COPCs in on-site soil through dermal contact. Skin surface areas (SA) used in the on-site resident exposure scenario were developed for a reasonable worst case scenario for an individual wearing a short-sleeved shirt, shorts, and shoes. The exposed skin surface area was limited to the head, hands, forearms, and lower legs. Thus, applying 25 percent of the mean total body surface area (20,000 cm²) results in a default of 5,000 cm² for adults. The exposed skin surface for a child (2,000 cm²) was estimated from the 50th (0.866 m²) percentile body surface for a six year old child multiplied by 25 percent (USEPA, 1992). Exposure duration, exposure frequencies, body weights, and averaging times were the same as those discussed for the incidental ingestion scenario presented previously. The values for AF and ABS were provided above and are in accordance with USEPA and Region IV guidance.

Future On-Site Residents

Future on-site residents could also be potentially exposed to COPCs in on-site soil through dermal contact experienced during activities near their homes. Skin surface areas (SA) used in the on-site resident exposure scenario were developed for a reasonable worst case scenario for an individual wearing a short-sleeved shirt, shorts, and shoes. The exposed skin surface area was limited to the head, hands, forearms, and lower legs. Thus, applying 25 percent of the total upper 90th percentile body surface area (23,000 cm²) results in a default of 5,800 cm² for adults. The exposed skin surface for a child (2,300 cm²) was estimated using an average of the 50th (0.866 m²) and 90th (1.06 cm²) percentile body surface for a six year old child multiplied by 25 percent (USEPA, 1992). Exposure duration, exposure frequencies, body weights, and averaging times were the same as those discussed for the incidental ingestion scenario presented previously. The values for AF and ABS were provided above and are in accordance with USEPA and Region IV guidance.

Future Construction Worker

Dermal contact with subsurface soil COPCs could potentially occur during excavation activities. Skin surface area (SA) used for the construction worker exposure scenario were developed for an individual wear a short-sleeved shirt, long pants, and boots. The exposed skin surface area (4,300 cm²) was limited to the head (1,180 cm²), arms (2,280 cm²), and hands (840 cm²) (USEPA, 1992). The exposure frequency and exposure duration are the same as those discussed for incidental

ingestion of subsurface soil. The values for AF and ABS were provided above and are in accordance with USEPA and Region IV guidance.

A summary of the soil exposure assessment input parameters for dermal contact is presented in Table 6-4.

6.3.4.3 Inhalation of Fugitive Particulates

Exposure to fugitive particulates was estimated for base personnel, future residents, trespassers, and construction workers. These populations may be exposed during daily recreational or work-related activities. The chronic daily intake of contaminants associated with the inhalation of particulates was estimated using the following equation:

$$CDI = \frac{C \times IR \times ET \times EF \times ED \times 1/PEF}{BW \times AT}$$

Where:

C	=	Contaminant concentration in soil (mg/kg)
IR	=	Inhalation rate (m ³ /day)
EF	=	Exposure frequency (days/year)
ED	=	Exposure duration (years)
1/PEF	=	Particulate emission factor, 1/(1.32x10 ⁹) (m ³ /kg)
BW	=	Body weight (kg)
AT	=	Averaging time (days)

The PEF relates the concentration in soil with the concentration of respirable particles in the air from fugitive dust emission. This relationship is derived by Cowherd (1985). The particulate emissions from contaminated sites are caused by wind erosion, and, therefore, depend on erodibility of the surface material. A default PEF, 1.32x10⁹, obtained from USEPA guidance to be published in late 1995 (per phone conversation with Janine Dinan of USEPA, USEPA, 1995c), was used in this assessment.

The following paragraphs discuss the exposure assumptions used in the estimation of exposure to COPCs from the inhalation of particulates.

Military Personnel

During work related activities, military personnel may inhale COPCs emitted as fugitive dust. An inhalation rate 30 m³/day was used for military personnel (USEPA, 1991). Values for exposure duration, exposure frequency, body weight, and averaging time were the same as those used for the incidental ingestion scenario.

Trespassers

Trespasser may also inhale particulates. Inhalation rates (IR) used in this exposure scenario were 20 m³/day and 15 m³/day for adults and children, respectively (USEPA, 1989). Exposure frequencies, duration, body weights, and averaging time were the same as those used for the incidental ingestion scenario. Table 6-4 presents the exposure factors used to estimate CDIs associated with the particulate inhalation scenario.

Future On-Site Residents

Future on-site residents may also inhale particulates. Inhalation rates (IR) used in the on-site resident exposure scenario were 20 m³/day and 15 m³/day for adults and children, respectively (USEPA, 1989). Exposure frequencies, duration, body weights, and averaging time were the same as those used for the incidental ingestion scenario. Table 6-4 presents the exposure factors used to estimate CDIs associated with the particulate inhalation scenario.

Future Construction Worker

Future construction workers could become exposed to subsurface soil particulates during excavation activities. The inhalation rate (IR) used was 20 m³/day (USEPA, 1989). Exposure frequencies, duration, body weight, and averaging time were the same as those used for the soil incidental ingestion scenario. Table 6-4 presents the exposure factors used to estimate CDIs associated with the particulate inhalation scenario.

6.3.4.4 Ingestion of Groundwater

As stated previously, shallow groundwater is not currently being used as a potable supply at Site 54. Development of the shallow aquifer for potable use is unlikely because of its general water quality and poor flow rates. However, residential housing could be constructed in the future and groundwater used for potable purposes.

The CDI of contaminants associated with the future potential consumption of groundwater was estimated using the following general equation:

$$CDI = \frac{C \times IR \times EF \times ED}{BW \times AT}$$

Where:

C	=	Contaminant concentration in groundwater (mg/L)
IR	=	Ingestion rate (L/day)
EF	=	Exposure frequency (days/year)
ED	=	Exposure duration (years)
BW	=	Body weight (kg)
AT	=	Averaging time (days)

The following paragraphs discuss the exposure assumptions used in the estimation of exposure to COPCs from the ingestion of groundwater.

Future On-Site Residents

Exposure to COPCs via ingestion of groundwater was retained as a potential future exposure pathway for both children and adults. An IR of 1.0 L/day was used for the amount of water consumed by a 1 to 6 year old child weighing 15 kg. The IR for an adult receptor was 2.0 L/day. This ingestion rate provides a conservative exposure estimate (for systemic, noncarcinogenic toxicants) designed to protect young children who may be more affected than adolescents, or adults. This value assumes that children obtain all the tap water they drink from the same source for

350 days/year (which represents the exposure frequency [EF]). An averaging time (AT) of 2,190 days (6 years x 365 days/year) is used for noncarcinogenic compound exposure. The ingestion rate (IR) for adults was 2 liters/day (USEPA, 1989a). The ED used for the estimation of adult CDIs was 30 years (USEPA, 1989), which represents the national upper-bound (90th percentile) time at one residence. The averaging time for noncarcinogens was 10,950 days. An averaging time (AT) of 25,550 days (70 years x 365 days/year) was used to evaluate exposure for both children and adults to potential carcinogenic compounds. Table 6-4 presents a summary of the input parameters for the ingestion of groundwater scenarios.

6.3.4.5 Dermal Contact with Groundwater

The CDI associated with the dermal contact with groundwater was estimated using the following general equation:

$$CDI = \frac{C \times SA \times PC \times ET \times EF \times ED \times CF}{BW \times AT}$$

Where:

C	=	Contaminant concentration in groundwater (mg/L)
SA	=	Surface area available for contact (cm ²)
PC	=	Dermal permeability constant (cm/hr)
ET	=	Exposure time (hour/day)
EF	=	Exposure frequency (days/year)
ED	=	Exposure duration (years)
CF	=	Conversion factor (1 L/1000 cm ³)
BW	=	Body weight (kg)
AT	=	Averaging time (days)

The following paragraphs discuss the exposure assumptions used in the estimation of exposure to COPCs from dermal contact with groundwater.

Future On-Site Residents

Children and adults could contact COPCs through dermal contact with groundwater while bathing or showering. It was assumed that bathing would take place 350 days/year using site groundwater as the sole source. The whole body skin surface area (SA) available for dermal absorption was estimated to be 10,000 cm² for children and 23,000 cm² for adults (USEPA, 1992). The permeability constant (PC) reflects the movement of a chemical across the skin and into the blood stream. The permeability of a chemical is an important property in evaluating actual absorbed dose, yet many compounds do not have literature PC values. For contaminants in which a PC value has not been established, the permeability constant was calculated (see Appendix Q). An exposure time (ET) of 0.25 hour/day was used to conservatively estimate the duration of bathing or showering. The exposure duration, body weight, and averaging time were the same as those used for the ingestion of groundwater scenario. Table 6-4 presents the exposure factors used to estimate CDIs associated with the future dermal contact with COPCs in groundwater.

6.3.4.6 Inhalation of Volatile Organics While Showering

In order to quantitatively assess the inhalation of contaminants volatilized from shower water, the model developed by Foster and Chrostowski (Foster, 1987) was utilized (see Appendix Q). Contaminant concentrations in air were modeled by estimating the following: the rate of chemical releases into air (generation rate), the buildup of VOCs in the shower room air while the shower was on, the decay of VOCs in the shower room after the shower was turned off, and the quantity of airborne VOCs inhaled while the shower was both on and off. The contaminant concentrations calculated to be in the air were then used as the concentration term.

The CDIs associated with the inhalation of airborne (vapor phase) VOCs from groundwater while showering were estimated using the following general equation:

$$CDI = \frac{C \times IR \times ET \times EF \times ED}{BW \times AT}$$

Where:

C	=	Contaminant concentration in air (mg/m ³)
IR	=	Inhalation rate (m ³ /hr)
ET	=	Exposure time (hr/day)
EF	=	Exposure frequency (days/year)
ED	=	Exposure duration (years)
BW	=	Body weight (kg)
AT _c	=	Averaging time carcinogen (days)
AT _{nc}	=	Averaging time noncarcinogen (days)

Future On-Site Residents

Both children and adults could inhale volatile COPCs while showering. It was assumed that showering would take place 350 days/year, using site groundwater as the sole source, for children weighing 15 kg, and adults weighing 70 kg (USEPA, 1989). An inhalation rate of 0.6 m³/hr was used for both receptors (USEPA, 1989). An exposure time of 0.25 hrs/day was used for both receptors (USEPA, 1989). The exposure duration and averaging times remained the same as for groundwater ingestion. Table 6-4 presents the exposure factors used to estimate CDIs associated with the inhalation of VOCs from groundwater while showering.

6.4 Toxicity Assessment

The purpose of this section is to define the toxicological values used to evaluate the exposure to the COPCs identified in Section 6.2.4. A toxicological evaluation characterizes the inherent toxicity of a compound. It consists of the review of scientific data to determine the nature and extent of the potential human health and environmental effects associated with exposure to various contaminants.

Human data from occupational exposures are often insufficient for determining quantitative indices of toxicity because of uncertainties in exposure estimates and inherent difficulties in determining causal relationships established by epidemiological studies. For this reason, animal bioassays are conducted under controlled conditions and their results are extrapolated to humans. There are several stages to this extrapolation. First, to account for species differences, conversion factors are used to extrapolate from test animals to humans. Second, the relatively high doses administered to

test animals must be extrapolated to the lower doses more typical of human exposures. For potential noncarcinogens, safety factors and modifying factors are applied to animal results when developing acceptable human doses. For potential carcinogens, mathematical models are used to extrapolate effects at high doses to effects at lower doses. Epidemiological data can be used for inferential purposes to establish the credibility of the experimentally derived indices.

The available toxicological information indicates that many of the COPCs have both potential carcinogenic and noncarcinogenic health effects in humans and/or experimental animals. Although the COPCs may cause adverse health and environmental impacts, dose-response relationships and the potential for exposure must be evaluated before the risk to receptors can be determined. Dose-response relationships correlate the magnitude of the dose with the probability of toxic effects, as discussed in the following section.

An important component of the risk assessment is the relationship between the dose of a compound (amount to which an individual or population is potentially exposed) and the potential for adverse health effects resulting from the exposure to that dose. Dose-response relationships provide a means by which potential public health impacts may be evaluated. The published information on doses and responses is used in conjunction with information on the nature and magnitude of exposure to develop an estimate of risk.

Standard carcinogenic slope factors (CSFs) and/or reference doses (RfDs) have been developed for many of the COPCs. This section provides a brief description of these parameters.

6.4.1 Carcinogenic Slope Factor

CSFs are used to estimate an upper-bound lifetime probability of an individual developing cancer as a result of exposure to a particular level of a potential carcinogen (USEPA, 1989). This factor is generally reported in units of $(\text{mg/kg/day})^{-1}$ and is derived through an assumed low-dosage linear multistage model and an extrapolation from high to low dose-responses determined from animal studies. The value used in reporting the slope factor is the upper 95th percent confidence limit.

These slope factors are also accompanied by USEPA weight-of-evidence (WOE) classifications, which designate the strength of the evidence that the COPC is a potential human carcinogen.

In assessing the carcinogenic potential of a chemical, the Human Health Assessment Group (HHAG) of USEPA classifies the chemical into one of the following groups, according to the weight of evidence from epidemiologic and animal studies:

- Group A** - **Human Carcinogen** (sufficient evidence of carcinogenicity in humans)
- Group B** - **Probable Human Carcinogen** (B1 - limited evidence of carcinogenicity in humans; B2 - sufficient evidence of carcinogenicity in animals with inadequate or lack of evidence in humans)
- Group C** - **Possible Human Carcinogen** (limited evidence of carcinogenicity in animals and inadequate or lack of human data)
- Group D** - **Not Classifiable as to Human Carcinogenicity** (inadequate or no evidence)
- Group E** - **Evidence of Noncarcinogenicity for Humans** (no evidence of carcinogenicity in adequate studies)

6.4.2 Reference Dose

The RfD is developed for chronic and/or subchronic human exposure to chemicals and is based solely on the noncarcinogenic effects of chemical substances. It is defined as an estimate of a daily exposure level for the human population, including sensitive populations, that is not likely to cause an appreciable risk of adverse effects during a lifetime. The RfD is usually expressed as dose (mg) per unit body weight (kg) per unit time (day). It is generally derived by dividing a no-observed-(adverse)-effect-level (NOAEL or NOEL) or a lowest observed-adverse-effect-level (LOAEL) for the critical toxic effect by an appropriate uncertainty factor (UF). Effect levels are determined from laboratory or epidemiological studies. The UF is based on the availability of toxicity data.

UFs usually consist of multiples of 10, where each factor represents a specific area of uncertainty naturally present in the extrapolation process. These UFs are presented below and were taken from the Risk Assessment Guidance Document for Superfund, Volume I, Human Health Evaluation Manual (Part A) (USEPA, 1989):

- A UF of 10 is to account for variation in the general population and is intended to protect sensitive populations (e.g., elderly, children).
- A UF of 10 is used when extrapolating from animals to humans. This factor is intended to account for the interspecies variability between humans and other mammals.
- A UF of 10 is used when a NOAEL derived from a subchronic instead of a chronic study is used as the basis for a chronic RfD.
- A UF of 10 is used when a LOAEL is used instead of a NOAEL. This factor is intended to account for the uncertainty associated with extrapolating from LOAELs to NOAELs.

In addition to UFs, a modifying factor (MF) is applied to each reference dose and is defined as:

- A MF ranging from >0 to 10 is included to reflect a qualitative professional assessment of additional uncertainties in the critical study and in the entire data base for the chemical not explicitly addressed by the preceding uncertainty factors. The default for the MF is 1.

Thus, the RfD incorporates the uncertainty of the evidence for chronic human health effects. Even if applicable human data exist, the RfD still maintains a margin of safety so that chronic human health effects are not underestimated.

Toxicity factors and the USEPA WOE classifications are presented in Table 6-6. The hierarchy (USEPA, 1989) for choosing these values was as follows:

- Health Effects Assessment Summary Table (HEAST, USEPA, 1995)
- Integrated Risk Information System (IRIS, USEPA, 1995a)

The IRIS data base is updated monthly and contains both verified CSFs and RfDs. The USEPA has formed the Carcinogen Risk Assessment Verification Endeavor (CRAVE) Workgroup to review and validate toxicity values used in developing CSFs. Once the slope factors have been verified via extensive peer review, they appear in the IRIS data base. Like the CSF Workgroup, the USEPA has formed a RfD Workgroup to review existing data used to derive RfDs. Once the reference doses has been verified, they also appear in IRIS.

HEAST on the other hand, provides both interim (unverified) and verified CSFs and RfDs. This document is published quarterly and incorporates any applicable changes to its data base.

Toxicity values will be obtained primarily from the Region III Risk-Based Concentration Table, which is based on IRIS, HEAST and provisional and/or recommended USEPA toxicity values, in accordance with Region IV recommendations.

For some chemicals, there are no USEPA-verified toxicity values (i.e., RfDs and CSFs) available for risk quantitation. This is the case for lead. The following section provides a discussion of how lead health effects were quantified for this assessment.

For other chemicals, the toxicity values of similarly structured compounds were substituted. For this site, the chemical substitute was naphthalene for 2-methylnaphthalene. In addition, there are some chemicals with different toxicity values associated with the medium in which they are detected. For example, the oral RfD for cadmium differs when found in food or water. Consequently, the oral RfD associated with food were applied for assessing soil exposure, and the oral RfD associated with water were used accordingly.

6.4.3 Lead

Lead was identified as a COPC in the groundwater at Site 54. Currently, health-based criteria are not available for evaluating either the noncarcinogenic or carcinogenic effects of lead exposure. The USEPA has not developed health-based criteria because a threshold level for many noncancer health effects has not been identified in infants and younger children (i.e., the most sensitive populations). Consequently, risk from lead exposure was not calculated for the site.

To evaluate lead at waste sites, the USEPA had developed a lead uptake/biokinetic (UBK) model. This model utilizes site-specific exposure parameters to estimate blood lead levels in infants and young children. The USEPA considers remediation necessary if a 5 percent probability or greater exists that the predicted child blood level will exceed 10 µg/dl as a result of contact with lead-containing media at the site.

There are several criteria available for lead level comparisons in the form of standards, criteria and/or TBCs. These standards/criteria/TBCs include federal and state MCLs and AWQC. In addition, there is an Office of Solid Waste and Emergency Response (OSWER) directive for lead in soil. The concentration is 400 mg/kg in residential soil. Lead in groundwater at the site exceeded the federal action level. Consequently, the lead UBK model was utilized to evaluate the risk associated with exposure to lead-containing groundwater at Site 54.

6.4.4 Dermal Adjustment of Toxicity Factors

Because there are few toxicity reference values for dermal exposure, oral values are frequently used to assess risk from dermal exposure. Most RfDs and some slope factors are expressed as the amount of substance administered per unit time and unit body weight, while exposure estimates for the dermal route are expressed as absorbed dose. Consequently, it may be necessary to adjust an oral toxicity value from an administered dose to an absorbed dose.

Region IV provides absorption efficiency values for each class of chemicals. They are as follows:

VOCs	=	0.80
SVOCs	=	0.50
Inorganics	=	0.20
Pesticides/PCBs	=	0.50

An adjusted oral RfD is the product of the absorption efficiency and the oral toxicity reference value. The adjusted oral CSF is the ratio of the oral toxicity value and the absorption efficiency. Table 7-7 presents a summary of the dermally-adjusted toxicity values used in this BRA.

6.5 Risk Characterization

This section presents and discusses the estimated incremental lifetime cancer risks (ICRs) and hazard indices (HIs) for identified potential receptor groups which could be exposed to COPCs via the exposure pathways presented in Section 6.3.2.

These quantitative risk calculations for potentially carcinogenic compounds estimate ICRs levels for an individual in a specified population. This unit risk refers to the cancer risk that is over and above the background cancer risk in unexposed individuals. For example, an ICR of 1×10^{-6} indicates that, for a lifetime exposure, one additional case of cancer may occur per one million exposed individuals.

The ICR to individuals was estimated from the following relationship:

$$ICR = \sum_{i=1}^n CDI_i \times CSF_i$$

where CDI_i is the chronic daily intake (mg/kg/day) for compound i and CSF_i is the cancer slope in $(\text{mg/kg/day})^{-1}$ for contaminant i . The CSF is defined in most instances as an upper 95th percentile confidence limit of the probability of a carcinogenic response based on experimental animal data, and the CDI is defined as the exposure expressed as a mass of a substance contracted per unit body weight per unit time, averaged over a period of time (i.e., six years to a lifetime). The above equation was derived assuming that cancer is a non-threshold process and that the potential excess risk level is proportional to the cumulative intake over a lifetime.

In contrast to the above approach for potentially carcinogenic effects, quantitative risk calculations for noncarcinogenic compounds assume that a threshold toxicological effect exists. Therefore, the potential for noncarcinogenic effects is calculated by comparing CDIs with threshold levels (reference doses).

Noncarcinogenic effects were estimated by calculating the hazard index (HI) which is defined as:

$$HI = HQ_1 + HQ_2 + \dots HQ_n \text{ or}$$

$$HI = \sum_{i=1}^n HQ_i$$

$$\text{where } HQ_i = CDI_i / RfD_i$$

HQ_i is the hazard quotient for contaminant i, CDI_i is the chronic daily intake (mg/kg/day) of contaminant i, and RfD_i is the reference dose (mg/kg/day) of the contaminant i over a prolonged period of exposure.

6.5.1 Human Health Risks

The following paragraphs present the quantitative results of the human health evaluation for each medium and area of concern at Site 54.

Estimated ICRs were compared to the target risk range of 1×10^{-6} to 1×10^{-4} . A value of 1.0 was used for examination of the HI. The HI was calculated by comparing estimated CDIs with threshold levels below which, noncarcinogenic health effects are not expected to occur. Any HI equal to or exceeding 1.0 suggested that noncarcinogenic health effects were possible. If the HI was less than 1.0, then systemic human health effects were considered unlikely. Tables 6-8 through 6-13 present these risk results.

6.5.1.1 Current Military Personnel

The current military receptor was evaluated for potential noncarcinogenic and carcinogenic risk from exposure to the surface soil. The noncarcinogenic (i.e., $HI < 0.01$) and carcinogenic risks (i.e., $ICR = 8 \times 10^{-8}$) fell below the acceptable risk levels (i.e., $HI < 1$ and $1 \times 10^{-6} < ICR < 1 \times 10^{-4}$). These results are presented in Table 6-8.

6.5.1.2 Current Trespasser Child

In the current scenario, a child trespasser was evaluated for potential risk from exposure to site surface soils. The potential noncarcinogenic and carcinogenic risks from exposure to the surface soil (i.e., $HI < 0.01$ and $ICR = 2.7 \times 10^{-7}$) were within acceptable risk levels (i.e., $HI < 1$ and $1 \times 10^{-6} < ICR < 1 \times 10^{-4}$). The results are summarized in Table 6-9.

6.5.1.3 Future Residential Child

The child receptor was evaluated for potential risk from exposure to subsurface soil and groundwater in the future scenario. In subsurface soil, the potential noncarcinogenic and carcinogenic risks from exposure to the subsurface soil (i.e., $HI = 0.19$ and $ICR = 5 \times 10^{-7}$) were within acceptable risk levels (i.e., $HI < 1$ and $1 \times 10^{-6} < ICR < 1 \times 10^{-4}$). The results are summarized in Table 6-10.

In groundwater, there is a potential noncarcinogenic risk from ingestion for the child receptor. The noncarcinogenic risk level was 18.6 from groundwater ingestion. This value exceeded the

acceptable risk level of one for noncarcinogenic risks. Arsenic and iron in groundwater contributed to this risk. The risk results are presented in Table 6-10.

6.5.1.4 Current Trespasser Adult

In the current scenario, an adult trespasser was evaluated for potential risk from exposure to site surface soils (i.e., $HI < 0.01$ and $ICR = 6.4 \times 10^{-8}$). The potential noncarcinogenic and carcinogenic risks from exposure to this medium were within acceptable risk levels (i.e., $HI < 1$ and $1 \times 10^{-6} < ICR < 1 \times 10^{-4}$). These results are provided in Table 6-11.

6.5.1.5 Future Residential Adult

The adult receptor was evaluated for potential risk from exposure to subsurface soil and groundwater in the future scenario. In subsurface soil (i.e., $HI = 0.025$ and $ICR = 3.3 \times 10^{-7}$), the potential noncarcinogenic and carcinogenic risks from exposure to this medium were within acceptable levels (i.e., $HI < 1$ and $1 \times 10^{-6} < ICR < 1 \times 10^{-4}$).

In groundwater, the potential noncarcinogenic and carcinogenic risks from ingestion do not fall within acceptable risk levels. The potential noncarcinogenic risk from groundwater ingestion was 8.3. The total potential carcinogenic risk from groundwater was 1.4×10^{-4} . These risk values exceeded the acceptable risk levels of one for noncarcinogenic risks and 1×10^{-4} for carcinogenic risks. Arsenic and iron contributed to the risks. Arsenic exhibits both noncarcinogenic and carcinogenic effects. Iron is a noncarcinogen. Table 6-12 is a summary of these results.

6.5.1.7 Future Construction Worker

The construction worker was evaluated for potential noncarcinogenic and carcinogenic risk from exposure to the surface and subsurface soil in the future case. Both noncarcinogenic (i.e., $HI = 0.03$) and carcinogenic risks (i.e., $ICR = 4 \times 10^{-8}$) from exposure to the soil for this receptor fell within the acceptable risk levels. Table 6-13 presents these results.

6.6 Lead UBK Model Results

The USEPA lead UBK model was used to determine if exposure to site media would result in unacceptable blood lead levels in younger children upon exposure to the soil and groundwater at Site 54. Blood lead levels are considered unacceptable when a greater than 5 percent probability exists that the blood lead levels will exceed 10 $\mu\text{g}/\text{dl}$.

The maximum concentrations of lead found in the groundwater was used in the model. The remaining model parameters used were the default factors supplied in the model. The maximum concentration in groundwater resulted in a greater than 5 percent probability of the blood lead levels exceeding 10 $\mu\text{g}/\text{dl}$, which is not within acceptable levels. Figures 6-2 and 6-3 illustrate these results.

6.7 Sources of Uncertainty

Uncertainties may be encountered throughout the BRA process. This section discusses the sources of uncertainty involved with the following:

- Analytical data
- Exposure Assessment
- Toxicity Assessment
- Compounds Not Qualitatively Evaluated

In addition, the USEPA stresses the importance of recognizing the unique characteristics and circumstances of each facility and the need to formulate site-specific responses. However, many of the assumptions presented in this document were derived from USEPA guidance, which is designed to provide a conservative approach and cover a broad variety of cases. As such, the generic application of such assumptions to a site in the RME case scenario may work against the objective of formulating a site-specific response to a constituent presence (i.e., it is possible that the site risks may be overestimated).

The following sections provide a discussion of the sources of uncertainty associated with this BRA and the effects on total site risk. Table 6-14 is a summary of these sources.

6.7.1 Analytical Data

The development of a BRA depends on the reliability of and uncertainties with the analytical data available to the risk assessor. Analytical data are limited by the precision and accuracy of the analytical method of analysis. In addition, the statistical methods used to compile and analyze the data (mean concentration, standard deviation, and detection frequencies) are subject to the uncertainty in the ability to acquire data.

Data validation serves to reduce some of the inherent uncertainty associated with the analytical data by establishing the usability of the data to the risk assessor who may or may not choose to include the data point in the estimation of risk. Data qualified as "J" (estimated) were retained for the estimation of risk at OU No.7. Data can be qualified as estimated for many reasons including a slight exceedance of holding times, high or low surrogate recovery, or intra sample variability. Organic data qualified "B" (detected in blank) were not used in the estimation of risk because these levels were attributed to blank contamination. Data qualified with an "R" (rejected) were not used in the estimation of risk due to the unusable nature of the data. Section 4.1 presents a brief discussion of the data quality. Due to the comprehensive sampling and analytical program at OU No. 6, the loss of some data points qualified "B" or "R" did not significantly increase the uncertainty in the estimation of risk.

The rejected data were related to re-analyzed and diluted results. Data was replaced with the re-analyzed or diluted value. In other cases, data were rejected due to blank contamination, noncompliant internal standard areas or low matrix spike recovery. Only one soil sample analyzed for SVOCs was rejected for exceeding the extraction holding time. Overall, the data quality was acceptable.

6.7.2 Exposure Assessment

In performing exposure assessments, uncertainties can arise from two main sources. First, the chemical concentration to which a receptor may be exposed must be estimated for every medium of interest. Second, uncertainties can arise in the estimation of contaminant intakes resulting from contact by a receptor with a particular medium.

Estimating the contaminant concentration in a given medium to which a human receptor could potentially be exposed can be as simple as deriving the 95th percent upper confidence limit of the mean for a data set. More complex methods of deriving the contaminant concentration are necessary when exposure to COPCs in a given medium occurs subsequent to release from another medium, or when analytical data are not available to characterize the release. In this case, modeling is usually employed to estimate the potential human exposure.

The potential inhalation of fugitive dusts from affected soils was estimated in the BRA using USEPA's Rapid Assessment of Exposure to Particulate Emissions from Surface Contaminated Sites (Cowherd et al. 1985). The Cowherd model employs the use of a default PEF for wind erosion based on a one-half acre source area and 50 percent vegetative cover. Modeling results for fugitive dust emission exposure suggested that the potential risk associated with this pathway was not significant.

Groundwater samples were analyzed for total (unfiltered) and dissolved (filtered) inorganic contaminants. These samples were obtained from wells which were constructed using USEPA Region IV monitoring well design specifications. Groundwater taken from monitoring wells cannot be considered representative of potable groundwater or groundwater which is obtained from a domestic well "at the tap". The use of total inorganic analytical results overestimates the potential human health risks associated with potable use scenarios. However, for the sake of conservatism, total organic results were used to estimate the potential intake associated with groundwater use.

To estimate an intake, certain assumptions must be made about exposure events, exposure durations, and the corresponding assimilation of contaminants by the receptor. Exposure factors, have been generated by the scientific community and have undergone review by the USEPA. Regardless of the validity of these exposure factors, they have been derived from a range of values generated by studies of limited number of individuals. In all instances, values used in the risk assessment, scientific judgments, and conservative assumptions agree with those of the USEPA. Conservative assumptions designed not to underestimate daily intakes were employed throughout the BRA and should error conservatively, thus adequately protecting human health and allowing the establishment of reasonable clean-up goals.

6.7.3 Sampling Strategy

Soil represents a medium of direct contact exposure and often is the main source of contaminants released into other media. The soil sampling depth should be applicable for the exposure pathways and contaminant transport routes of concern and should be chosen purposely within that depth interval. If a depth interval is chosen purposely, a random sample procedure to select a sampling point may be established. The assessment of surface exposure at the site is certain based on collection of samples from the shallowest depth, zero to one foot. Subsurface soil samples are important, however, if soil disturbance is likely or leaching of chemicals to groundwater is of concern.

The surface soil samples at all sites were obtained directly or very near the suspected disposal areas. Therefore, these areas would be considered areas of very high concentration which would have a significant impact on exposures.

In the future exposure scenarios, subsurface soil exposure was evaluated. It was assumed that the subsurface soil would be excavated and used as surface grading, landscaping, etc., in the foreseeable

future. It is important to note that many of these subsurface soil samples were collected at depths ranging from 1 foot to possibly up to 90 feet, depending on the depth of the well from which the soil boring was collected. It may be unrealistic to assume that excavation could occur at such depths. It follows that exposure to contaminants in soil at these depths would be unlikely for future receptors. However, for the BRA, the subsurface soil analytical results were not segregated by depth, but were evaluated as a single data set. Consequently, levels found at all depths were evaluated for potential risk to human health. The use of the entire subsurface soil data set may add to the conservative nature of the approach used to assess risk for this site.

6.7.4 Toxicity Assessment

In making quantitative estimates of the toxicity of varying doses of a compound to human receptors, uncertainties arise from two sources. First, data on human exposure and the subsequent effects are usually insufficient, if they are available at all. Human exposure data usually lack adequate concentration estimations and suffer from inherent temporal variability. Therefore, animal studies are often used; and, therefore, new uncertainties arise from the process of extrapolating animal results to humans. Second, to obtain observable effects with a manageable number of experimental animals, high doses of a compound are used over a relatively short time period. In this situation, a high dose means that experimental animal exposures are much greater than human environmental exposures. Therefore, when applying the results of the animal experiment to humans, the effects at the high doses must be extrapolated to approximate effects at lower doses.

In extrapolating effects from animals to humans and high doses to low doses, scientific judgment and conservative assumptions are employed. In selecting animal studies for use in dose-response calculations, the following factors are considered:

- Studies are preferred where the animal closely mimics human pharmacokinetics
- Studies are preferred where dose intake most closely mimics the intake route and duration for humans
- Studies are preferred which demonstrate the most sensitive response to the compound in question

For compounds believed to cause threshold effects (i.e., noncarcinogens), safety factors are employed in the extrapolation of effects from animals to humans and from high to low doses.

Conservatism is also introduced through the use of experimentally-derived oral absorption efficiencies to adjust oral toxicity criteria (i.e., CSFs and RfDs), derived during studies based on administered dosages, for the estimation of dermal absorption. Equating the absorption efficiency of the bi-phasic dermal barrier to that of the mono-phasic gastrointestinal lining and then applying it to oral toxicity criteria in a dermal risk assessment scenario tends to generally overestimate the potential risk to human health by no more than an order of magnitude.

The use of conservative assumptions results in quantitative indices of toxicity that are not expected to underestimate potential toxic effects, but may overestimate these effects by an order of magnitude or more.

6.8 Conclusions of the BRA for Site 54

The BRA highlights the media of interest from the human health standpoint at Site 54 by identifying areas with risk values greater than acceptable levels. Current and future potential receptors at the site included current military personnel, current trespassers (i.e., children and adults), future residents (i.e., children and adults), and future construction workers. The total risk from the site for these receptors was estimated by logically summing the multiple pathways likely to affect the receptor during a given activity. Exposure to surface soil was assessed for the current receptors. Subsurface soil and groundwater exposure were evaluated for the future receptors.

6.8.1 Current Scenario

In the current case, the following receptors were assessed: military personnel and adult and child trespassers. Receptor exposure to surface soil was evaluated. The calculated risk values for these receptors were within acceptable risk levels.

6.8.2 Future Scenario

In the future case, child and adult residents were assessed for potential exposure to groundwater and subsurface soil. A construction worker was evaluated for surface and subsurface soil exposure. The future risk calculated for the construction worker was within acceptable risk levels.

The total noncarcinogenic risk and carcinogenic risk for the adult resident exceeded acceptable risk levels of one for noncarcinogenic effects and 1×10^{-4} for carcinogenic effects. These values were 8.3 and 1.4×10^{-4} , respectively. The total noncarcinogenic risk for the child resident, 20, was also greater than the acceptable risk level of one. In both cases, groundwater ingestion was the main exposure route contributing to these unacceptable risks. In terms of lead effects, exposure to the maximum concentration of lead in the groundwater for a child receptor indicates the potential for adverse health effects. The maximum levels of iron and lead and the lognormal 95% UCL value of arsenic in groundwater contributed to these risks. Table 6-15 provides a summary of these concentrations.

As stated previously, groundwater is not currently used as a potable water source at Site 54. Future residential development of the site is unlikely given the industrial setting of the site and its proximity to the flight line. Based on this information, the future groundwater exposure scenario evaluated in this BRA is unlikely to occur.

Arsenic was detected frequently in the site groundwater at levels greater than the risk-based screening level. However, these same levels were below both federal and state safe drinking water criteria (i.e., MCLs).

As explained in Section 4.0 of this report, groundwater in the MCB, Camp Lejeune area is naturally rich in iron. There is no record of any historical use of iron at Site 54. Positive detections of both iron and manganese were distributed throughout the site, indicative of natural site conditions rather than disposal activities. It is suggested that total metal concentrations in groundwater are due more to geologic conditions (i.e., naturally occurring concentrations and unconsolidated soils) and sample acquisition methods than to mobile metal concentrations in the surficial aquifer. Consequently, it is assumed that iron is a naturally-occurring inorganic in groundwater, and its presence is not attributable to site operations.

Iron is an essential nutrient. The toxicity values associated with exposure to this metal are based on provisional studies, which have not been verified by USEPA. In fact, if iron were removed from the evaluation of risk from groundwater ingestion, the noncarcinogenic risk for the child would decrease from 19 to 3 and, for the adult, from 8 to 1.2, which is only slightly greater than the acceptable noncarcinogenic risk value of one. As a result, the potential human health risk from exposure to iron in groundwater is a conservative and unrealistic estimate.

6.9 References

Cowherd et al., 1985. Cowherd, C. et al. Rapid Assessment of Exposure to Particulate Emissions from Surface Contamination. Prepared for EPA Office of Health and Environmental Assessment. EPA/600/8-85/002.

Foster, 1986. Foster, S.A. and P.C. Chrostowski. "Integrated Household Exposure Model for Use of Tap Water Contaminated with Volatile Organic Chemicals." Presented at the 79th Annual Meeting of the Air Pollution Control Association, Minneapolis, Minnesota. June 22-27, 1986.

USEPA, 1989. U.S. Environmental Protection Agency. Risk Assessment Guidance for Superfund Volume I. Human Health Evaluation Manual (Part A) Interim Final. Office of Solid Waste and Emergency Response. Washington, D.C. EPA/540/1-89-002. December 1989.

USEPA, 1989a. U.S. Environmental Protection Agency. Exposure Factors Handbook. July 1989.

USEPA, 1990. U.S. Protection Agency. National Oil and Hazardous Substances Pollution Contingency Plan. 55FR8665. Office of Emergency and Remedial Response. Washington, D.C. March 1990.

USEPA, 1991. U.S. Environmental Protection Agency. Risk Assessment Guidance for Superfund Volume I. Human Health Evaluation Manual Supplemental Guidance. "Standard Default Exposure Factors" Interim Final. Office of Solid Waste and Emergency Response. Washington, D.C. OSWER Directive 9285.6-03. March 25, 1991.

USEPA, 1992. U.S. Environmental Protection Agency. Dermal Exposure Assessment: Principles and Applications. Interim Report. Office of Health and Environmental Assessment. Washington, D.C. EPA/600/8-91/011B. January 1992.

USEPA, 1992a. U.S. Environmental Protection Agency. New Interim Region IV Guidance for Toxicity Equivalency Factor (TEF) Methodology. Region IV Water Management Division.

USEPA, 1992b. U.S. Environmental Protection Agency. Supplemental Guidance to RAGS: Calculating the Concentration Term. Office of Solid Waste and Emergency Response. Washington, D.C., Publication 9285.7-081. May 1992.

USEPA, 1992c. U.S. Environmental Protection Agency. Region IV Waste Management Division Screening Values for Hazardous Waste Sites. Region IV, Atlanta Georgia. January 1992.

USEPA, 1992d. USEPA Region IV Supplemental Risk Guidance. February 11, 1992.

USEPA, 1993. U.S. Environmental Protection Agency. Region IV Waste Management Division Screening Values for Hazardous Waste Sites. Region IV, Atlanta Georgia. January 1993.

USEPA. 1995. U.S. Environmental Protection Agency. Health Effects Assessment Summary Tables Annual FY-1995. Office of Solid Waste and Emergency Response. Washington, D.C. EPA/540/R-95/036 PB95-921199. May 1995.

USEPA, 1995a. U.S. Environmental Protection Agency. Integrated Risk Information System (IRIS). Environmental Criteria and Assessment Office, Cincinnati, Ohio.

USEPA, 1995b. U.S. Environmental Protection Agency. Region III Risk-Based Concentration Table. Philadelphia, Pennsylvania. October, 1995.

USEPA, 1995c. U. S. Environmental Protection Agency. Phone conversation with Janine Dinan. Washington, D.C. November 17, 1995.

WAR, 1983. Water and Air Research, Inc. Initial Assessment Study of Marine Corps Base Camp Lejeune, North Carolina. Prepared for Naval Energy and Environmental Support Activity. 1983.

SECTION 6.0 TABLES

TABLE 6-1

**CONTAMINANTS OF POTENTIAL CONCERN
IN SURFACE SOIL
SITE 54, CRASH CREW FIRE TRAINING BURN PIT
REMEDIAL INVESTIGATION CTO-0303
MCAS, NEW RIVER, NORTH CAROLINA**

Contaminant	Minimum	Maximum	Lognormal UCL	Location of Maximum	Frequency	Frequency Percent	Site Background	Exceedance Frequency	Residential Soil RBC	Exceedance Frequency
Semivolatiles (µg/kg)										
n-Nitrosodiphenylamine	160	160	200.01	54-DD-SB01-00	1/11	9%	NA	NA	130,000	0/1
Phenanthrene	98	120	209.58	54-DD-SB03-00	2/11	18%	NA	NA	230,000	0/2
Fluoranthene	62	67	239.70	54-DD-SB01-00	2/11	18%	NA	NA	310,000	0/2
Pyrene	99	150	208.88	54-DD-SB01-00	2/11	18%	NA	NA	230,000	0/2
Butylbenzylphthalate	50	320	271.13	54-DD-SB04-00	2/11	18%	NA	NA	1,600,000	0/2
Bis(2-ethylhexyl)phthalate	59	820	354.82	54-DD-SB01-00	6/11	55%	NA	NA	46,000	0/6
Di-n-octylphthalate	150	150	200.76	54-SB08-00	1/11	9%	NA	NA	160,000	0/1
Inorganics (mg/kg)										
Aluminum	4,680	6,930	7,480.58	54-DD-SB04-00	4/4	100%	5,940.6	2/4	7800	0/4
Arsenic	0.3	0.79	1.95	54-DD-SB02-00	4/4	100%	1.31	0/4	2.3/0.43	3/4
Barium	12.3	26.9	49.37	54-DD-SB01-00	4/4	100%	17.4	3/4	550	0/4
Calcium	37,700	142,000	722,261.47	54-DD-SB02-00	4/4	100%	1,396.8	4/4	NA	NA
Chromium	5.7	9.1	11.93	54-DD-SB04-00	4/4	100%	6.7	3/4	39	0/4
Cobalt	0.71	0.71	1.04	54-DD-SB04-00	1/4	25%	1.9	0/4	470	0/4
Copper	2.8	7.2	13.60	54-DD-SB01-00	4/4	100%	7.2	0/4	310	0/4
Iron	2,150	3,640	4,452.63	54-DD-SB04-00	4/4	100%	37,55.1	0/4	2,300	3/4
Lead	9.7	23	40.90	54-DD-SB02-00	4/4	100%	23.7	0/4	400	0/4
Magnesium	633	2,030	6,375.60	54-DD-SB02-00	4/4	100%	205.8	4/4	NA	NA
Manganese	10.5	23.9	37.76	54-DD-SB02-00	4/4	100%	18.5	1/4	510 ¹	0/4
Potassium	273	367	7,164.38	54-DD-SB01-00	3/4	75%	199.6	3/4	NA	NA
Sodium	93.6	179	210.64	54-DD-SB02-00	4/4	100%	59.3	4/4	NA	NA
Vanadium	7	11.8	14.45	54-DD-SB04-00	4/4	100%	11.6	1/4	55	0/4
Zinc	8.3	16.7	26.70	54-DD-SB04-00	4/4	100%	13.9	2/4	2,300	0/4

Notes:

COPCs indicated by the shaded areas.

¹ RBC based on an oral RfD of 0.14 mg/kg/day.

TABLE 6-2

**CONTAMINANTS OF POTENTIAL CONCERN
IN SUBSURFACE SOIL
SITE 54, CRASH CREW FIRE TRAINING BURN PIT
REMEDIAL INVESTIGATION CTO-0303
MCAS, NEW RIVER, NORTH CAROLINA**

Contaminant	Minimum	Maximum	Lognormal UCL	Location of Maximum	Frequency	Frequency Percent	Site Background	Exceedance Frequency	Residential Soil RBC	Exceedance Frequency
Volatiles (µg/kg)										
Acetone	1,200	1,200	76.54	54-DD-SB05-01	1/19	5%	NA	NA	780,000	0/1
Xylene (total)	12	300	30.74	54-SB08-01	2/19	11%	NA	NA	16,000,000	0/2
Semivolatiles(µg/kg)										
Naphthalene	760	760	251.26	54-SB08-01	1/19	5%	NA	NA	310,000	0/1
2-Methylnaphthalene	1,700	1,700	315.68	54-DD-SB05-01	1/19	5%	NA	NA	310,000	0/1
Acenaphthene	94	94	201.10	54-DD-SB05-01	1/19	5%	NA	NA	470,000	0/1
Fluorene	420	420	219.76	54-DD-SB05-01	1/19	5%	NA	NA	310,000	0/1
Phenanthrene	160	160	194.86	54-DD-SB05-01	1/19	5%	NA	NA	230,000	0/1
Pyrene	43	43	220.56	54-DD-SB05-01	1/19	5%	NA	NA	230,000	0/1
Butylbenzylphthalate	56	56	212.20	54-DD-SB03-01	1/19	5%	NA	NA	1,600,000	0/1
Bis(2-ethylhexyl)phthalate	49	49	216.90	54-DD-SB05-01	1/19	5%	NA	NA	46,000	0/1
Inorganics (mg/kg)										
Aluminum	344	13,400	25,783.18	54-DD-SB04-01	8/8	100%	7,375.30	1/8	7,800	1/8
Arsenic	0.46	0.46	0.29	54-SB03-01	1/8	13%	1.97	0/1	2.3/0.43	1/1
Barium	3	27.5	73.79	54-DD-SB04-01	7/8	88%	14.20	1/7	550	0/7
Calcium	60.9	5,220	4,913,545.73	54-SB03-01	7/8	88%	391.51	4/7	NA	NA
Chromium	0.88	12	12.46	54-DD-SB04-01	7/8	88%	12.56	0/7	39	0/7
Cobalt	1.2	1.2	0.65	54-DD-SB04-01	1/8	13%	1.50	0/1	470	0/1
Copper	0.48	1.1	1.08	54-SB03-01	4/8	50%	2.42	0/4	310	0/4
Iron	125	3,150	9,937.21	54-SB03-01	8/8	100%	7,252.08	0/8	2,300	4/8
Lead	1.4	11.5	16.95	54-DD-SB03-01	8/8	100%	8.33	3/8	400	0/8
Magnesium	16.3	387	514.07	54-DD-SB04-01	8/8	100%	260.72	1/8	NA	NA
Manganese	0.38	7.5	17.29	54-SB05-01	8/8	100%	7.92	0/8	510 ¹	0/8
Nickel	1.1	6.2	6.60	54-DD-SB02-02	6/8	75%	3.71	2/6	160	0/6
Potassium	18	248	224.71	54-DD-SB04-01	5/8	63%	347.24	0/5	NA	NA

TABLE 6-2 (Continued)

CONTAMINANTS OF POTENTIAL CONCERN
 IN SUBSURFACE SOIL
 SITE 54, CRASH CREW FIRE TRAINING BURN PIT
 REMEDIAL INVESTIGATION CTO-0303
 MCAS, NEW RIVER, NORTH CAROLINA

Contaminant	Minimum	Maximum	Lognormal UCL	Location of Maximum	Frequency	Frequency Percent	Site Background	Exceedance Frequency	Residential Soil RBC	Exceedance Frequency
Inorganics (mg/kg) (Continued)										
Sodium	10.3	38.6	66.83	54-SB05-01	4/8	50%	52.68	0/4	NA	NA
Vanadium	0.54	12.6	28.94	54-DD-SB04-01	7/8	88%	13.45	0/7	55	0/7
Zinc	1.2	4	8.84	54-DD-SB04-01	7/8	88%	6.66	0/7	2,300	0/7

Notes:

COPCs indicated by the shaded areas.

¹ RBC based on an oral RfD of 0.14 mg/kg/day.

TABLE 6-3

**CONTAMINANTS OF POTENTIAL CONCERN
IN GROUNDWATER
SITE 54, CRASH CREW FIRE TRAINING BURN PIT
REMEDIAL INVESTIGATION CTO-0303
MCAS, NEW RIVER, NORTH CAROLINA**

Contaminants	Minimum	Maximum	Lognormal UCL	Location of Maximum	Frequency	Frequency Percent	Tap Water RBC	Exceedance Frequency	Federal MCL	Exceedance Frequency	N.Carolina WQS	Exceedance Frequency
Volatiles (µg/L)												
Carbon Disulfide	4.00	4.00	5.06	54-GW10-01	1/17	6%	100	0/1	NA	NA	700	0/1
1,2-Dichloroethene (total)	5.00	23.00	7.21	54-TW03-01	3/17	18%	5.5	2/3	70	0/3	NA	NA
Trichloroethene	1.00	1.00	5.88	54-TW03-01	1/17	6%	1.6	0/1	5	0/1	NA	NA
Benzene	5.00	40.00	14.83	54-TW04-01	6/17	35%	0.36	6/6	5	5/6	1	6/6
Toluene	22.00	83.00	12.89	54-TW03-01	2/17	12%	75	1/2	1,000	0/2	1,000	0/2
Ethylbenzene	6.00	26.00	9.28	54-TW04-01	3/17	18%	130	0/3	700	0/3	29	0/3
Xylene (total)	27.00	130.00	20.28	54-TW03-01	3/17	18%	1,200	0/3	10,000	0/3	530	0/3
Semivolatiles (µg/L)												
Phenol	1.00	1.00	9.85	54-TW04-01	1/17	6%	2,200	0/1	NA	NA	300	0/1
Nitrobenzene	2.00	2.00	9.09	54-TW04-01	1/17	6%	0.34	1/1	NA	NA	NA	NA
2,4-Dimethylphenol	3.00	3.00	8.88	54-GW06-01	1/17	6%	73	0/1	NA	NA	NA	NA
Naphthalene	1.00	240.00	126.66	54-TW03-01	7/17	41%	150	1/7	NA	NA	21	5/7
2-Methylnaphthalene	1.00	160.00	41.30	54-TW03-01	6/17	35%	150	1/6	NA	NA	NA	NA
Diethylphthalate	1.00	37.00	9.37	54-TW03-01	5/17	29%	2,900	0/5	NA	NA	5,000	0/5
Anthracene	1.00	1.00	9.85	54-TW05-01	1/17	6%	1100	0/1	NA	NA	2,100	0/1
Di-n-butylphthalate	1.00	2.00	9.86	54-GW09-01	2/17	12%	370	0/2	NA	NA	700	0/2
Bis(2-ethylhexyl)phthalate	1.00	1.00	10.60	54-GW10-01	2/17	12%	4.8	0/2	NA	NA	3	0/2
Inorganics (µg/L)												
Aluminum	206.00	5,340.00	1,759.43	54-GW10-01	3/13	23%	3,700	1/3	NA	NA	NA	NA
Arsenic	2.80	24.70	7.17	54-TW03-01	4/13	31%	1.1/0.045	4/4	50	0/4	50	0/4
Barium	26.30	68.90	53.22	54-GW05-01	12/13	92%	260	0/12	2,000	0/12	2,000	0/12
Calcium	3,230.00	91,500.00	112,296.57	54-GW08-01	13/13	100%	NA	NA	NA	NA	NA	NA
Chromium	10.30	10.30	2.93	54-GW10-01	1/13	8%	18	0/1	100	0/1	50	0/1
Cobalt	5.90	20.90	14.81	54-GW06-01	4/13	31%	220	0/4	NA	NA	NA	NA
Iron	193.00	74,100.00	512,096.09	54-TW03-01	12/13	92%	1,100	7/13	NA	NA	300	9/12

TABLE 6-3 (Continued)

CONTAMINANTS OF POTENTIAL CONCERN
 IN GROUNDWATER
 SITE 54, CRASH CREW FIRE TRAINING BURN PIT
 REMEDIAL INVESTIGATION CTO-0303
 MCAS, NEW RIVER, NORTH CAROLINA

Contaminants	Minimum	Maximum	Lognormal UCL	Location of Maximum	Frequency	Frequency Percent	Tap Water RBC	Exceedance Frequency	Federal MCL	Exceedance Frequency	N.Carolina WQS	Exceedance Frequency
Inorganics (µg/L) (Continued)												
Lead	1.90	39.70	14.28	54-GW02-01	5/13	38%	NA	NA	15	1/5	15	1/5
Magnesium	1,430.00	6,550.00	4,006.83	54-TW01-01	13/13	100%	NA	NA	NA	NA	NA	NA
Manganese	25.20	1,280.00	1,461.46	54-GW03-01	13/13	100%	510 ¹	3/13	NA	NA	50	9/13
Nickel	14.10	61.60	25.17	54-TW02-01	4/13	31%	73	0/4	100	0/4	100	0/4
Potassium	885.00	3,960.00	2,487.69	54-GW02-01	8/13	62%	NA	NA	NA	NA	NA	NA
Sodium	3,390.00	27,800.00	12,933.90	54-TW03-01	13/13	100%	NA	NA	NA	NA	NA	NA
Zinc	8.20	24.70	13.30	54-GW10-01	3/13	23%	1,100	0/3	NA	NA	2,100	0/3

Notes:

COPCs indicated by the shaded areas.

¹ The tap water RBC for manganese is based on an oral RfD of 0.14 mg/kg/day and not 0.005 mg/kg/day, as listed in the Region III RBC table (October, 1995). The latter toxicity value has been withdrawn from IRIS.

TABLE 6-4

**SUMMARY OF EXPOSURE DOSE INPUT PARAMETERS
SITE 54, CRASH CREW FIRE TRAINING BURN PIT
REMEDIAL INVESTIGATION CTO-0303
MCAS, NEW RIVER, NORTH CAROLINA**

Input Parameter	Units	Receptor					
		Trespasser Child	Trespasser Adult	Military Personnel	Construction Worker	Residential Child	Residential Adult
Soil (mg/kg)							
Ingestion Rate, IR	mg/d	200	50	100	480	200	100
Fraction Ingested, FI	unitless	1	1	1	1	1	1
Exposure Frequency, EF	d/y	130	43	250	90	350	350
Exposure Duration, ED	y	6	30	4	1	6	30
Surface Area, SA	cm ²	2,000	5,000	4,300	4,300	2,300	5,800
Adherence Factor, AF	mg/cm ²	1	1	1	1	1	1
Averaging Time, Noncarc., ATnc	d	2,190	10,950	1,460	365	2,190	10,950
Averaging Time, Carc., ATcarc	d	25,550	25,550	25,550	25,550	25,550	25,550
Body Weight, BW	kg	15	70	70	70	15	70
Conversion Factor, CF	kg/mg	1x10 ⁻⁶	1x10 ⁻⁶	1x10 ⁻⁶	1x10 ⁻⁶	1x10 ⁻⁶	1x10 ⁻⁶
Absorbance Factor, ABS	unitless	Organics = 0.01; Inorganics = 0.001					
Groundwater (mg/L)							
Ingestion Rate, IR	L/d	NA	NA	NA	NA	1	2
Exposure Frequency, EF	d/y	NA	NA	NA	NA	350	350
Exposure Duration, ED	y	NA	NA	NA	NA	6	30
Exposure Time, ET	h/d	NA	NA	NA	NA	0.25	0.25
Surface Area, SA	cm ²	NA	NA	NA	NA	10,000	23,000
Averaging Time, Noncarc., ATnc	d	NA	NA	NA	NA	2,190	10,950
Averaging Time, Carc., ATcarc	d	NA	NA	NA	NA	25,550	25,550
Conversion Factor, CF	L/cm ³	NA	NA	NA	NA	0.001	0.001
Body Weight, BW	kg	NA	NA	NA	NA	15	70

TABLE 6-4 (Continued)

SUMMARY OF EXPOSURE DOSE INPUT PARAMETERS
 SITE 54, CRASH CREW FIRE TRAINING BURN PIT
 REMEDIAL INVESTIGATION CTO-0303
 MCAS, NEW RIVER, NORTH CAROLINA

Input Parameter	Units	Receptor					
		Trespasser Child	Trespasser Adult	Military Personnel	Construction Worker	Residential Child	Residential Adult
Air (mg/m³)							
Outdoor Air							
Inhalation Rate, IR	m ³ /d	15	20	30	20	15	20
Exposure Frequency, EF	d/y	130	43	250	90	350	350
Exposure Duration, ED	y	6	30	4	1	6	30
Averaging Time, Noncarc., ATnc	d	2,190	10,950	1,460	365	2,190	10,950
Averaging Time, Carc., ATcarc	d	25,550	25,550	25,550	25,550	25,550	25,550
Body Weight, BW	kg	15	70	70	70	15	70
Shower Air							
Inhalation Rate, IR	m ³ /h	NA	NA	NA	NA	0.6	0.6
Exposure Time, ET	h/d	NA	NA	NA	NA	0.25	0.25
Exposure Frequency, EF	d/y	NA	NA	NA	NA	350	350
Exposure Duration, ED	y	NA	NA	NA	NA	6	30
Averaging Time, Noncarc., ATnc	d	NA	NA	NA	NA	2,190	10,950
Averaging Time, Carc., ATcarc	d	NA	NA	NA	NA	25,550	25,550
Body Weight, BW	kg	NA	NA	NA	NA	15	70

References:

- USEPA Risk Assessment For Superfund Volume I. Human Health Manual (Part A) Interim Final, December, 1989.
- USEPA Exposure Factors Handbook, July, 1989.
- USEPA Risk Assessment For Superfund Volume I. Human Health Evaluation Manual Supplemental Guidance. "Standard Default Exposure Factors" Interim Final, March 25, 1991.
- USEPA Dermal Exposure Assessment: Principles and Applications. Interim Report. January, 1992.
- USEPA Region IV Guidance for Soil Absorbance. (USEPA, 1992)

TABLE 6-4 (Continued)

**SUMMARY OF EXPOSURE DOSE INPUT PARAMETERS
SITE 54, CRASH CREW FIRE TRAINING BURN PIT
REMEDIAL INVESTIGATION CTO-0303
MCAS, NEW RIVER, NORTH CAROLINA**

Notes:

The exposure frequency for the trespasser receptors is based on the typical exposure pattern (i.e., more time spent outdoors in the warmer months vs. the cooler months) for people who actively garden or play outdoors. It is an upper-bound estimate (USEPA, 1992).

The skin surface area for the trespasser receptors is based on approximately 25 percent of the total surface body area for a child and adult receptor. These values are upper-bound estimates.

TABLE 6-5

**SUMMARY OF EXPOSURE PATHWAYS
SITE 54, CRASH CREW FIRE TRAINING BURN PIT
REMEDIAL INVESTIGATION, CTO-0303
MCAS, NEW RIVER, NORTH CAROLINA**

Receptor	Exposure Pathway
Current Military Personnel	Surface soil ingestion, dermal contact and fugitive dust inhalation
Current Adult and Child Trespassers	Surface soil ingestion, dermal contact and fugitive dust inhalation
Future Construction Worker	Surface and subsurface soil ingestion, dermal contact, and fugitive dust inhalation
Future Residential Adult and Child	Subsurface soil ingestion, dermal contact and fugitive dust inhalation Groundwater ingestion, dermal contact and inhalation

TABLE 6-6

**SUMMARY OF HEALTH-BASED CRITERIA
SITE 54, CRASH CREW FIRE TRAINING BURN PIT
REMEDIAL INVESTIGATION CTO-0303
MCAS, NEW RIVER, NORTH CAROLINA**

Contaminant	Oral RfD mg/kg/d	Inhalation RfD mg/kg/d	Oral CSF (mg/kg/d) ⁽¹⁾	Inhalation CSF (mg/kg/d) ⁽¹⁾	Weight-of- Evidence ⁽¹⁾
1,2-Dichloroethene (total)	9.00E-03 (h)	--	--	--	D
Benzene	--	1.71E-03 (e)	2.90E-02 (i)	2.90E-02 (i)	A
Toluene	2.00E-01 (i)	1.14E-01 (i)	--	--	D
Nitrobenzene	5.00E-04 (i)	5.71E-04 (a)	--	--	D
Naphthalene	4.00E-02 (w)	--	--	--	D
2-Methylnaphthalene ⁽²⁾	4.00E-02 (w)	--	--	--	D
Aluminum	1.00E+00 (e)	--	--	--	--
Arsenic	3.00E-04 (i)	--	1.5E+00 (i)	1.51E+01 (i)	A
Iron	3.00E-01 (e)	--	--	--	--
Lead	--	--	--	--	B2
Manganese	1.4E-01 (i)	1.43E-05 (i)	--	--	--

Notes:

⁽¹⁾ Drinking Water Regulations and Health Advisories by Office of Water, USEPA, May, 1995.

⁽²⁾ Toxicity factor for naphthalene.

i = Integrated Risk Information System (IRIS, 1995)

e = Environmental Criteria and Assessment Office (ECAO) (as cited from October 1995 USEPA, Region III RBC Tables)

h = Health Effects Assessment Summary Tables (HEAST, 1995)

a = HEAST Alternative Method, 1994

w = Withdrawn from IRIS or HEAST

-- = Information not published or applicable.

TABLE 6-7

**SUMMARY OF DERMALLY ADJUSTED
HEALTH-BASED CRITERIA
SITE 54, CRASH CREW FIRE TRAINING BRUN PIT
REMEDIAL INVESTIGATION CTO-0303
MCAS, NEW RIVER, NORTH CAROLINA**

Contaminant	Percent Absorbed ⁽¹⁾	Oral RfD mg/kg/d	Dermally Adjusted Oral RfD mg/kg/d	Oral CSF (mg/kg/d) ⁽¹⁾	Dermally Adjusted Oral CSF (mg/kg/d) ⁽¹⁾
1,2-Dichloroethene (total)	80%	9.00E-03	7.2E-03	--	--
Benzene	80%	--	--	2.90E-02	3.6E-02
Toluene	80%	2.00E-01	1.6E-01	--	--
Nitrobenzene	50%	5.00E-04	2.5E-04	--	--
Naphthalene	50%	4.00E-02	2.0E-02	--	--
2-Methylnaphthalene	50%	4.00E-02	2.0E-02	--	--
Aluminum	20%	1.00E+00	2.0E-01	--	--
Arsenic	20%	3.00E-04	6.0E-05	1.5E+00	7.5E+00
Iron	20%	3.00E-01	6.0E-02		
Lead	20%	--	--	--	--
Manganese	20%	1.40E-01	2.8E-02	--	--

Notes:

⁽¹⁾ Region IV recommended values (i.e., 80% for VOCs, 50% for SVOCs, and 20% for inorganics)

RfD = USEPA-verified reference dose

CSF = USEPA-verified cancer slope factor

-- = No toxicity value is available or applicable

Dermally-adjusted RfD = oral RfD * percent absorbed

Dermally-adjusted CSF = oral CSF / percent absorbed

TABLE 6-8

**SUMMARY OF RISKS FOR THE
MILITARY RECEPTOR
SITE 54, CRASH CREW FIRE TRAINING BURN PIT
REMEDIAL INVESTIGATION CTO-0303
MCAS, NEW RIVER, NORTH CAROLINA**

Exposure Pathway	Noncarcinogenic Risk	Carcinogenic Risk
Surface Soil		
Ingestion	2.6E-03	6.6E-08
Dermal Contact	5.5E-04	1.4E-08
Inhalation	--	1.5E-10
Total Risk	3.1E-03	8.1E-08

Notes:

-- = Not Applicable

TABLE 6-9

SUMMARY OF RISKS FOR THE
CHILD TRESPASSER
SITE 54, CRASH CREW FIRE TRAINING BURN PIT
REMEDIAL INVESTIGATION CTO-0303
MCAS, NEW RIVER, NORTH CAROLINA

Exposure Pathway	Noncarcinogenic Risk	Carcinogenic Risk
Surface Soil		
Ingestion	6.3E-03	2.4E-07
Dermal Contact	6.3E-04	2.4E-08
Inhalation	--	2.8E-10
total	6.9E-03	2.7E-07

Notes:

-- = Not Applicable

TABLE 6-10

**SUMMARY OF RISKS FOR THE
FUTURE CHILD RESIDENT
SITE 54, CRASH CREW FIRE TRAINING BURN PIT
REMEDIAL INVESTIGATION CTO-0303
MCAS, NEW RIVER, NORTH CAROLINA**

Exposure Pathway	Noncarcinogenic Risk	Carcinogenic Risk
Subsurface Soil		
Ingestion	1.8E-01	4.7E-07
Dermal Contact	1.1E-02	2.7E-08
Inhalation	--	2.7E-10
total	1.9E-01	5.0E-07
Groundwater		
Ingestion	18.6	6.1E-05
Dermal Contact	3.6E-01	8.9E-07
Inhalation	7.9E-01	2.4E-06
total	19.7	6.5E-05
Future Risk	20	6.5E-05

Notes:

-- = Not Applicable

Bolded values indicate risk values that exceed the acceptable risk value of 1.0 for noncarcinogenic effects.

TABLE 6-11

SUMMARY OF RISKS FOR THE
ADULT TRESPASSER
SITE 54, CRASH CREW FIRE TRAINING BURN PIT
REMEDIAL INVESTIGATION CTO-0303
MCAS, NEW RIVER, NORTH CAROLINA

Exposure Pathway	Noncarcinogenic Risk	Carcinogenic Risk
Surface Soil		
Ingestion	2.2E-04	4.3E-08
Dermal Contact	1.1E-04	2.1E-08
Inhalation	--	1.3E-10
Total Risk	3.3E-04	6.4E-08

Notes:

-- = Not Applicable

TABLE 6-12

**SUMMARY OF RISKS FOR THE
FUTURE ADULT RESIDENT
SITE 54, CRASH CREW FIRE TRAINING BURN PIT
REMEDIAL INVESTIGATION CTO-0303
MCAS, NEW RIVER, NORTH CAROLINA**

Exposure Pathway	Noncarcinogenic Risk	Carcinogenic Risk
Subsurface Soil		
Ingestion	2.0E-02	2.5E-07
Dermal Contact	5.7E-03	7.4E-08
Inhalation	0.0E+00	3.9E-10
total	2.5E-02	3.3E-07
Groundwater		
Ingestion	8.0	1.3E-04
Dermal Contact	1.8E-01	2.2E-06
Inhalation	1.3E-01	1.9E-06
total	8.3	1.4E-04
Future Risk	8.3	1.4E-04

Notes:

Bolded values indicate risk values that exceed the acceptable risk value of 1.0 for noncarcinogenic effects or 1×10^{-4} for carcinogenic effects.

TABLE 6-13

SUMMARY OF RISKS FOR THE
 CONSTRUCTION WORKER
 SITE 54, CRASH CREW FIRE TRAINING BURN PIT
 REMEDIAL INVESTIGATION CTO-0303
 MCAS, NEW RIVER, NORTH CAROLINA

Exposure Pathway	Noncarcinogenic Risk	Carcinogenic Risk
Surface Soil		
Ingestion	4.5E-03	2.9E-08
Dermal Contact	2.0E-04	1.3E-09
Inhalation	--	9.1E-12
total	4.7E-03	3.0E-08
Subsurface Soil		
Ingestion	2.4E-02	1.0E-08
Dermal Contact	1.1E-03	4.7E-10
Inhalation	--	3.3E-12
total	2.5E-02	1.1E-08
Total Risk	3E-02	4E-08

TABLE 6-14

**SUMMARY OF UNCERTAINTIES IN THE RESULTS OF THE
HUMAN HEALTH RISK ASSESSMENT
SITE 54, CRASH CREW FIRE TRAINING BURN PIT
REMEDIAL INVESTIGATION CTO-0303
MCAS, NEW RIVER, NORTH CAROLINA**

	Potential Magnitude for Over-Estimation of Risks	Potential Magnitude for Under-Estimation of Risks	Potential Magnitude for Over or Under-Estimation of Risks
<u>Environmental Sampling and Analysis</u>			
Sufficient samples may not have been taken to characterize the media being evaluated.			Low
Systematic or random errors in the chemical analysis may yield erroneous data.			Low
<u>Selection of COPCs</u>			
The use of USEPA Region III COPC screening concentrations in selecting COPCs in soil and groundwater.			Low
<u>Exposure Assessment</u>			
The standard assumptions regarding body weight, exposure period, life expectancy, population characteristics, and lifestyle may not be representative of the actual exposure situations.			Moderate
The use of the 95th percentile upper confidence level data of the lognormal distribution in the estimation of the RME.			Low
Assessing future residential property use when the likelihood of residential development is low.	High		
The amount of media intake is assumed to be constant and representative of any actual exposure.			Low
<u>Toxicological Assessment</u>			
Toxicological indices derived from high dose animal studies, extrapolated to low dose human exposure.	Moderate		
Lack of promulgated toxicological indices for inhalation pathway.		Low	
<u>Risk Characterization</u>			
Assumption of additivity in the quantitation of cancer risks without consideration of synergism, antagonism, promotion and initiation.			Moderate

TABLE 6-14 (Continued)

SUMMARY OF UNCERTAINTIES IN THE RESULTS OF THE
HUMAN HEALTH RISK ASSESSMENT
SITE 54, CRASH CREW FIRE TRAINING BURN PIT
REMEDIAL INVESTIGATION, CTO-0303
MCB, CAMP LEJEUNE, NORTH CAROLINA

	Potential Magnitude for Over-Estimation of Risks	Potential Magnitude for Under-Estimation of Risks	Potential Magnitude for Over or Under-Estimation of Risks
Assumption of additivity in the estimation of systemic health effects without consideration of synergism, antagonism, etc.			Moderate
Additivity of risks by individual exposure pathways (dermal and ingestion and inhalation).	Low		Low
Compounds not quantitatively evaluated.		Low	

Notes:

Low = Assumptions categorized as "low" may effect risk estimates by less than one order of magnitude.

Moderate = Assumptions categorized as "moderate" may effect estimates of risk by between one and two orders of magnitude.

High = Assumptions categorized as "high" may effect estimates of risk by more than two orders of magnitude.

Source: Risk Assessment Guidance for Superfund, Volume 1, Part A: Human Health Evaluation Manual. USEPA, 1989a.

TABLE 6-14 (Continued)

SUMMARY OF UNCERTAINTIES IN THE RESULTS OF THE
HUMAN HEALTH RISK ASSESSMENT
SITE 54, CRASH CREW FIRE TRAINING BURN PIT
REMEDIAL INVESTIGATION, CTO-0303
MCB, CAMP LEJEUNE, NORTH CAROLINA

	Potential Magnitude for Over-Estimation of Risks	Potential Magnitude for Under-Estimation of Risks	Potential Magnitude for Over or Under-Estimation of Risks
Assumption of additivity in the estimation of systemic health effects without consideration of synergism, antagonism, etc.			Moderate
Additivity of risks by individual exposure pathways (dermal and ingestion and inhalation).	Low		Low
Compounds not quantitatively evaluated.		Low	

Notes:

- Low = Assumptions categorized as "low" may effect risk estimates by less than one order of magnitude.
- Moderate = Assumptions categorized as "moderate" may effect estimates of risk by between one and two orders of magnitude.
- High = Assumptions categorized as "high" may effect estimates of risk by more than two orders of magnitude.

Source: Risk Assessment Guidance for Superfund, Volume 1, Part A: Human Health Evaluation Manual. USEPA, 1989a.

TABLE 6-15

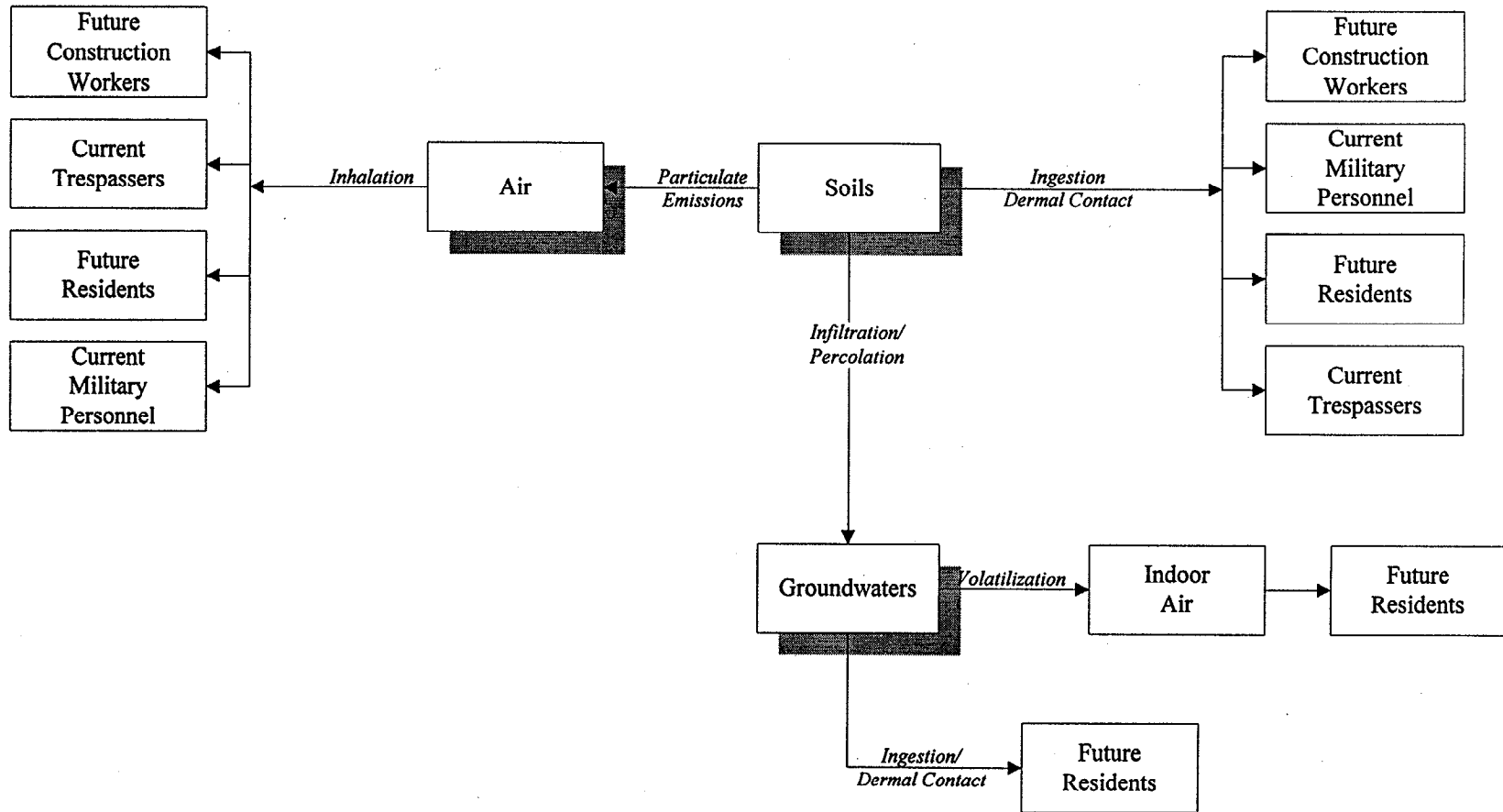
**SUMMARY OF CONTAMINANTS CONTRIBUTING TO SITE RISKS
SITE 54, CRASH CREW FIRE TRAINING BURN PIT
REMEDIAL INVESTIGATION CTO-0303
MCAS, NEW RIVER, NORTH CAROLINA**

Exposure Medium	Contaminant	Concentration
Groundwater	Arsenic	0.007 mg/L (<i>lognormal UCL</i>)
	Iron	74.1 mg/L (<i>maximum</i>)
	Lead	0.0397 mg/L (<i>maximum</i>)

SECTION 6.0 FIGURES

FIGURE 6-1

FLOWCHART OF POTENTIAL EXPOSURE PATHWAYS AND RECEPTORS
SITE 54: CRASH CREW FIRE TRAINING BURN PIT



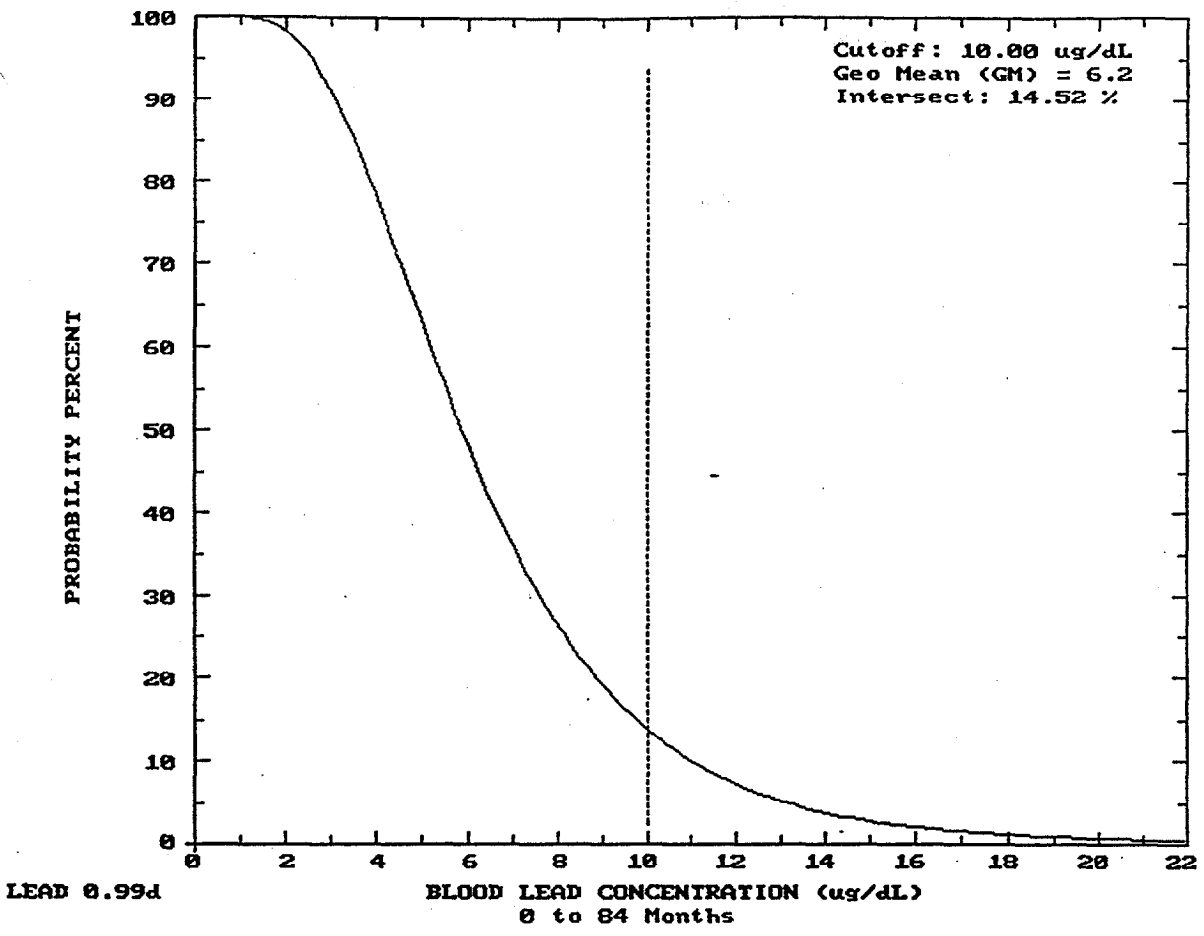


Figure 6-2
Cumulative Probability Percent of Blood Lead Levels
Site 54 Groundwater Exposure

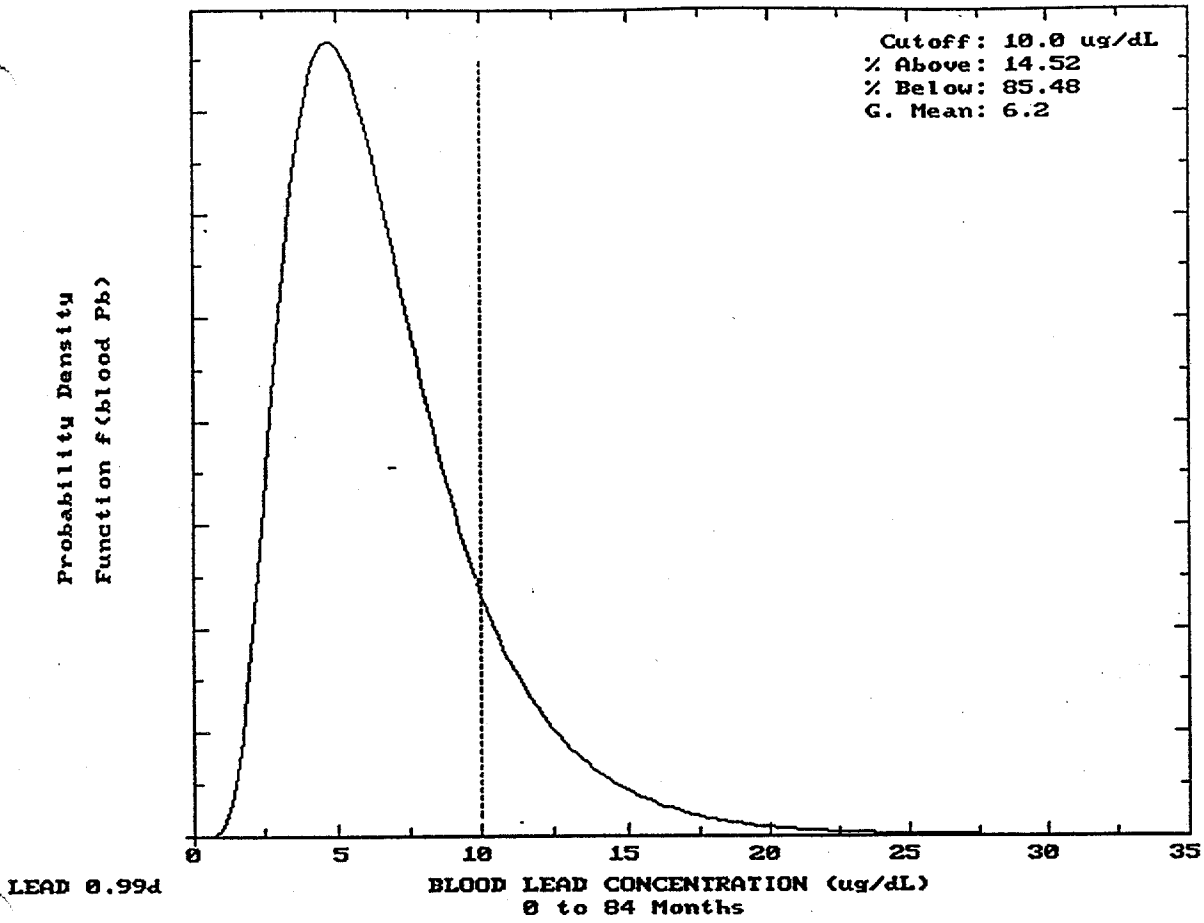


Figure 6-3
Probability Distribution of Blood Lead Levels
Site 54 Groundwater Exposure

7.0 ECOLOGICAL RISK ASSESSMENT

The Comprehensive Environmental Response, Compensation, and Liability Act of 1980 (CERCLA) as amended by the Superfund Amendments and Reauthorization Act (SARA) of 1986, directs USEPA to protect human health and the environment with respect to releases or potential releases of contaminants from abandoned hazardous waste sites (USEPA, 1989a). This section of the report presents the ecological risk assessment (ERA) conducted at Operable Unit No. 6, Site 54 and assesses the potential impacts to ecological receptors from contaminants detected at this site.

7.1 Objectives, Scope, and Organization of the Ecological Risk Assessment

The objective of this ERA is to evaluate if past reported disposal practices at Site 54 are potentially adversely impacting the terrestrial and aquatic communities on, or adjacent to, the site. This assessment also evaluates the potential effects of contaminants related to Site 54 on sensitive environments including wetlands and protected species. The conclusions of the ERA are used in conjunction with the human health risk assessment to evaluate the appropriate remedial action for this site for the overall protection of public health and the environment. If potential risks are characterized for the ecological receptors, further ecological evaluation of the site and surrounding areas may be warranted.

This ERA evaluates and analyzes the results from the Remedial Investigation (RI) including chemical analysis of the soil and groundwater. The media of concern for this ERA are the surface soil and groundwater. Information used to evaluate sensitive environments is obtained from historical data and previous studies obtained in the literature, or through conversations with appropriate state, Federal, and local personnel.

The risk assessment methodologies used in this evaluation are consistent with those outlined in the Ecological Risk Assessment Guidance for Superfund: Process for Designing and Conducting Ecological Risk Assessments (USEPA, 1994) and Framework for Ecological Risk Assessment (USEPA, 1992a). In addition, information found in the following documents was used to supplement the USEPA guidance document:

- USEPA Supplemental Risk Assessment Guidance for Superfund, Volume II, Environmental Evaluation Manual (USEPA, 1989b)
- Ecological Assessment of Hazardous Waste Sites: A Field and Laboratory Reference (USEPA, 1989c)

Based on the USEPA Framework for Ecological Risk Assessment, an ERA consists of three main components: 1) Problem Formulation; 2) Analysis; and, 3) Risk Characterization (USEPA, 1992a). The problem formulation section includes a preliminary characterization of exposure and effects of the stressors to the ecological receptors. During the analysis, the data is evaluated to determine the exposure and potential effects on the ecological receptors from the stressors. Finally, in the risk characterization, the likelihood of adverse effects occurring as a result of exposure to a stressor is evaluated. This section also evaluates the potential impact on the ecological receptors at the site from the contaminants detected in the media. This ERA is organized to parallel these three components.

7.2 Problem Formulation

Problem formulation is the first step of an ERA and includes a preliminary characterization of exposure and effects (USEPA, 1992a). Chemical analyses were performed on samples collected from the soil and groundwater to evaluate the presence, concentrations, and variabilities of the contaminants. A habitat characterization also was conducted as part of the field activities. Based on these observations, potential ecological receptors were identified. Finally, toxicological information for the contaminants detected in the media was obtained from available references and literature and used to evaluate the potential adverse ecological effects to the ecological receptors.

The components of the problem formulation include identifying the stressors and their potential ecological effects, identification of ecosystems potentially at risk, defining ecological endpoints and presenting a conceptual model. The following sections discuss each of these components, and how they are evaluated in this ERA.

7.3 Contaminants of Potential Concern

One of the initial steps in the problem formulation stage of an ERA is identifying the stressors and their potential ecological effects. For this ERA, the stressors that are evaluated include contaminants detected in the surface soil and groundwater. Typically, groundwater is not evaluated in an ERA. However, since surface water samples were not collected, and there are surface water bodies adjacent to Site 54 that the groundwater potentially may discharge to, the contaminants in the groundwater are evaluated as surface water. However, it should be noted that this is a very conservative approach since it does not account for mixing and fate and transport processes after discharging to a water body.

Contaminants in the subsurface soil are not evaluated in this ERA. Some terrestrial species burrow in the subsurface soil, however, current guidance does not provide sufficient information to evaluate risk to these receptors.

The nature and extent of contaminants detected in the environmental media at Site 54 are presented in Section 4.0 of this report. Sample locations are based on available historical site information and a site visit to evaluate potential ecosystems and ecological receptors.

7.3.1 Criteria for Selecting Contaminants of Potential Concern

Quantifying risk for all positively identified contaminants may distract from the dominant risk-driving contaminants at the site. Therefore, the data set was reduced to a list of contaminants of potential concern (COPCs). COPCs are site-related contaminants used to quantitatively estimate ecological exposures and associated potential ecological effects.

The criteria used in selecting the COPCs from the contaminants detected during the field sampling and analytical phase of the investigation are:

- Historical information
- Prevalence
- Toxicity
- Comparison to Federal and state criteria and standards
- Comparison to investigation associated field and laboratory blank data

- Comparison to background or naturally occurring levels
- Comparison to anthropogenic levels

7.3.1.1 Historical Information

Using historical information to associate contaminants with site activities, when combined with the following selection procedures, helps determine contaminant retention or elimination. To be conservative, contaminants detected in the media that may not have been historically used at a site are retained as COPCs to evaluate risk, but may be eliminated in the ecological significance section as not being site-related.

7.3.1.2 Prevalence

The frequency of positive detections in sample sets and the level at which contaminants are detected in a given medium are factors that determine a chemical's prevalence. Contaminants that were detected infrequently are not retained as COPCs.

7.3.1.3 Toxicity

The potential toxicity of a contaminant is an important consideration when selecting COPCs for further evaluation in the ERA. Several of the contaminants detected in the media at Site 54 are prevalent, however, their inherent toxicity to aquatic and terrestrial receptors is low (e.g., calcium, magnesium, potassium, and sodium). Therefore, they are not retained as COPCs. In addition, several contaminants have not been adequately studied to develop published toxicity values, or even accepted toxicological data with which to assess the contaminants. Contaminants that fall into this category are retained as COPCs (if they are not eliminated due to other criteria). However, they are not quantitatively evaluated in the ERA.

7.3.1.4 State and Federal Criteria and Standards

Water Quality Standards (WQS) for surface water have been developed for North Carolina (NC DEHNR, 1994). These are the only enforceable surface water standards. In addition to the WQS, Water Quality Screening Values (WQSVs) have been developed by USEPA Region IV (USEPA, 1995a), USEPA Region III (USEPA, 1995b), and Oak Ridge National Laboratory (ORNL) (Suter and Mabrey, 1994). The WQS and WQSVs will be herein referred to as Surface Water Screening Values (SWSVs).

The SWSVs are used for comparative purposes to infer potential ecological risks. Contaminants that were detected at concentrations less than these screening values are not retained as COPCs for aquatic receptors since contaminants detected at concentrations less than these values are not expected to pose a significant risk to the aquatic receptor population.

There are no state or Federal soil screening values that can be used to evaluate potential ecological risks to terrestrial receptors (other than plants or invertebrates). Therefore, toxicity of contaminants in the surface soil to terrestrial receptors is not used as criteria for retaining COPCs except for calcium, magnesium, potassium, and sodium, which are not retained as COPCs in any of the media.

A brief explanation of the standards, criteria, and screening values used for the evaluation of the COPCs is presented below.

North Carolina Water Quality Standards (Surface Water) - WQS are the concentrations of toxic substances that will not result in chronic toxicity to aquatic life (NC DEHNR, 1994). WQS are provided for both freshwater and saltwater aquatic systems.

USEPA Water Quality Screening Values - WQSVs are non-enforceable regulatory guidelines and are of primary utility in assessing acute and chronic toxic effects in aquatic systems. WQSVs are provided for both freshwater and saltwater aquatic systems, and are reported as acute and/or chronic values (USEPA, 1995a,b). Most of the WQSVs are the same as the USEPA Ambient Water Quality Criteria (AWQC), however, some of the WQSVs are based on more current studies.

Oak Ridge National Laboratory Aquatic Benchmarks - ORNL Aquatic Benchmarks are developed for many contaminants, including those that do not have WQS or WQSVs (Suter and Mabrey, 1994). The ORNL aquatic benchmarks include secondary acute values and secondary chronic values that are calculated using the Tier II method described in the EPA's Proposed Water Quality Guidance for the Great Lakes System (USEPA, 1993b). Tier II values are developed so that aquatic benchmarks could be established with fewer data than are required for the USEPA AWQC. The benchmarks are limited to contaminants in freshwater.

7.3.1.5 Field and Laboratory Blank Data

Associating contaminants detected in field related blanks (i.e., trip blanks, equipment rinsates and/or field blanks) or laboratory method blanks with the same contaminants detected in analytical samples can eliminate non-site-related contaminants from the list of COPCs. Blank data should be compared to sample results with which the blanks are associated. However, for this data set it is difficult to associate specific blanks with specific environmental samples. Thus, in order to evaluate detection levels, maximum contaminant concentrations reported in a given set of blanks are applied to a corresponding set of samples.

In accordance with the National Functional Guidelines for Organics, common lab contaminants (i.e., acetone, 2-butanone, methylene chloride, toluene, and phthalate esters) should be regarded as a direct result of site activities only when sample concentrations exceed 10 times the maximum blank concentration. For other contaminants not considered common in a lab, concentrations exceeding 5 times the maximum blank concentration indicate contamination resulting from site activities (USEPA, 1991a).

Contract Required Quantitation Limits (CRQLs) and percent moisture are employed when evaluating contaminant concentrations in soil, in order to correlate solid and aqueous detection limits. For example, the CRQL for semivolatiles in soil is 33 to 66 times that of aqueous samples, depending on the contaminant. In order to assess semivolatile contaminant levels in soil using aqueous blanks, the blank concentration must then also be multiplied by 33 or 66 to account for variance from the CRQL (common lab contaminants must first be multiplied by 5 or 10, as explained in the paragraph above). The final value is divided by the sample percent moisture.

Eliminating a sample result correlates directly to a reduction in the contaminant prevalence in that medium. Consequently, if elimination due to blank concentration reduces the prevalence of a contaminant to less than 5 percent, a contaminant that may have been included according to its prevalence is eliminated as a COPC.

Maximum concentrations of common laboratory contaminants detected in blanks are presented in Section 6.0, Table 6-1. Blanks containing organic constituents that are not considered common laboratory contaminants (i.e., all other TCL compounds) are regarded as positive results only when observed concentrations exceed 5 times the maximum concentration detected in any blank (USEPA, 1989a). All TCL compounds at less than 5 times the maximum level of contamination noted in any blank are considered not detected in that sample.

7.3.1.6 Background or Naturally Occurring Levels

Contaminants that were detected in the surface soil at concentrations less than two-times the average Base background concentration are not retained as COPCs.

7.3.1.7 Anthropogenic Levels

Ubiquitous anthropogenic background concentrations result from non-site related sources such as combustion of fossil fuels (i.e., automobiles), plant synthesis, natural fires and factories. Examples of ubiquitous, anthropogenic chemicals are polycyclic aromatic hydrocarbons (PAHs). Anthropogenic chemicals are typically not eliminated as COPCs without considering other selection criteria. It is difficult to determine that such chemicals are present at the site due to operations not related to the site or the surrounding area. Omitting anthropogenic background chemicals from the risk assessment may result in the loss of important information for those potentially exposed.

The following sections apply the aforementioned selection criteria beginning with the prevalence of detected analytical results in each medium of interest to establish a preliminary list of COPCs for Site 54. Once this task has been completed, a final list of media-specific COPCs will be selected based on the remaining criteria.

7.3.2 **Selection of Contaminants of Potential Concern**

The following sections present an overview of the analytical data obtained for each medium during the RI and the subsequent retention or elimination of COPCs using the aforementioned selection criteria. Contaminants that are not eliminated due to the above criteria are retained as COPCs. The primary reasons for retaining contaminants as a COPC include, but may not be limited to the following: (1) frequently detected, (2) detected at concentrations above the screening values (if available) and/or (3) detected at concentrations above background (if available). In addition, some common laboratory contaminants (i.e., phthalates) are retained as COPCs because they were detected frequently and were not detected in the blank samples. Finally, calcium, magnesium, potassium, and sodium are not retained as COPCs in any of the media because they are common naturally occurring chemicals, are not related to the site, and no published toxicity data was identified to assess potential impacts to aquatic or terrestrial life.

Table 7-1 presents the comparison of the total groundwater contaminant concentrations to the SWSVs. A comparison of the surface soil contaminant concentrations to base-background concentrations is presented in Section 6.0, Table 6-3. A summary of the COPCs retained in each media is presented in Table 7-2.

At Site 54, the ERA evaluated analytical data that was collected from the surface soil and groundwater. Surface water and sediment samples were not collected from any of the runoff ditches because they were either dry (in which case soil samples were collected), or they also were receiving

runoff from areas not related to Site 54. Since surface water samples were not collected at Site 54, contaminants in the groundwater wells are compared to the surface water screening values to evaluate potential impacts from contaminants related to Site 54. The groundwater samples will not be used in the terrestrial Chronic Daily Intake (CDI) models. The CDI models have a lot of inherent uncertainty that would be compounded further by assuming that the surface water concentration is equal to the groundwater concentration. Therefore, using these models with the additional uncertainty would not provide any useful information for this evaluation.

7.3.2.1 Surface Soil

Eleven surface soil samples were collected at Site 54. Four samples were analyzed for TAL metals and TCL PCBs, and eleven were analyzed for TCL VOCs and SVOCs. No samples were analyzed for TCL pesticides because they were not known to be site-related contaminants.

No VOCs were detected in the surface soil. Seven SVOCs were detected in the surface soil. Bis(2-ethylhexyl)phthalate, butylbenzylphthalate, di-n-octylphthalate, fluoranthene, n-nitrosodiphenylamine, phenanthrene and pyrene are all retained as COPCs.

Fifteen metals were detected in the surface soil. Arsenic, cobalt, copper, iron, and lead are not retained as COPCs because they were detected at concentrations less than two times the average base-background concentration. As presented above, calcium, magnesium, potassium, and sodium are not retained as COPCs. The remaining six metals (aluminum, barium, chromium, manganese, vanadium, and zinc) are retained as COPCs.

7.3.2.1 Groundwater

Seventeen groundwater samples were collected at Site 54. Thirteen samples were analyzed for TAL metals and TCL PCBs, seventeen were analyzed for TCL SVOCs and VOCs, and one was analyzed for TCL pesticides. Several of the metals' criteria are hardness dependent (cadmium, copper, lead, nickel, and zinc). The lowest hardness values were used to calculate the SWSVs since they produce the most conservative screening values. A hardness of 25 mg/L CaCO₃ was used for the metals. Some of the actual hardness values of the groundwater are less than this value, however, current guidance states that the minimum hardness value that can be used in the hardness equations is 25 mg/L CaCO₃ (USEPA, 1992b). Appendix U presents the hardness calculations.

Seven VOCs were detected in the groundwater. Benzene, carbon disulfide, ethylbenzene, 1,2-dichloroethene, toluene, and trichloroethene are not retained as COPCs because they were detected at concentrations below the SWSVs. The remaining VOC (xylenes) is retained as a COPC.

Nine SVOCs were detected in the groundwater. Bis(2-ethylhexyl)phthalate, diethylphthalate, di-n-butylphthalate, and phenol are not retained as COPCs because they were detected at concentrations below the SWSVs. The remaining five SVOCs (anthracene, 2,4-dimethylphenol, 2-methylnaphthalene, naphthalene, and nitrobenzene) are retained as COPCs. No pesticides were detected in the groundwater.

Fourteen metals were detected in the groundwater. Arsenic, chromium, and zinc are not retained as COPCs because they were detected at concentrations below the SWSVs. As presented above, calcium, magnesium, potassium, and sodium are not retained as COPCs. The remaining eight metals (aluminum, barium, cobalt, iron, lead, manganese, and nickel) are retained as COPCs.

7.3.3 Physical/Chemical Characteristics of COPCs

Physical and chemical characteristics of contaminants may affect their mobility, transport, and bioavailability in the environment. These characteristics include bioconcentration factors (BCFs), organic carbon partition coefficient (Koc), octanol water partition coefficient (Kow), and biotransfer factors (Bv, Bb, Br). Table 7-3 summarizes these values for the COPCs detected in the surface soil and groundwater. Information from these tables is used to assess the fate and transport of the contaminants and the potential risks to the environmental receptors at Site 54. The following paragraphs present the significance of each parameter included in the table.

Bioconcentration factors measure the tendency for a chemical to partition from the water column or sediment and concentrate in aquatic organisms. Bioconcentration factors are important for ecological receptors because chemicals with high BCFs could accumulate in lower-order species and subsequently accumulate to toxic levels in species higher up the food chain. The BCF is the concentration of the chemical in the organism at equilibrium divided by the concentration of the chemical in the water. Therefore, the BCF is unitless. The bioconcentration factor is used to evaluate a contaminant's bioconcentration potential in ecological receptors.

The organic carbon partition coefficient (Koc) measures the tendency for a chemical to partition between soil or sediment particles containing organic carbon and water. This coefficient is important in the ecological environment because it determines how strongly an organic chemical will be bound to the organics in the soil and sediment.

The octanol/water partition coefficient (Kow) is the ratio of a chemical concentration in octanol divided by the concentration in water. The octanol/water partition coefficient has been shown to correlate well with bioconcentration factors in aquatic organisms and with adsorption to soil or sediment. The Kow is used to calculate the plant and beef biotransfer factors (for organics) that are used to estimate the COPC concentration in plants and the small mammal that would potentially be ingested by the terrestrial receptors in the intake model.

The plant biotransfer factors (Bv or Br) measure the potential for a chemical to accumulate in a plant. These factors are used to calculate the concentration of the COPCs in either the leafy part of the plant (Bv) or the fruit of the plant (Br). The factors for inorganics are obtained from Baes et. al, (1984), while the factors for organics are calculated according to Travis and Arms (1988). The Bv and Br values for the organics are assumed to be same value.

Finally, the beef biotransfer factor (Bb) measures the potential for a chemical to accumulate in an animal. This factor is used to calculate the COPC concentration in the small mammal that is ingested by the red fox. The factors for inorganics are obtained from Baes et. al, (1984), while the factors for organics are calculated according to Travis and Arms (1988).

7.4 Ecosystems Potentially at Risk

Ecological receptors that might be potentially at risk from contaminants at Site 54 were identified during the field investigations and the habitat evaluation. The regional and site-specific ecologies are presented in Sections 1 and 2 of this report. Based on the results of the field investigations and the habitat evaluation, potential receptors of contaminants in surface water adjacent to Site 54 include the following: fish, benthic macroinvertebrates, other aquatic flora and fauna and some

terrestrial faunal species. Potential receptors of contaminants in soil include the following: deer, rabbits, foxes, raccoons, birds and other terrestrial flora and fauna.

7.5 Ecological Endpoints

The information compiled during the first stage of problem formulation (stressor characteristics and ecosystems potentially at risk) is used to select the ecological endpoints for this ERA. The following section presents the ecological endpoints selected for this ERA, and the reasons they are selected.

There are two primary types of ecological endpoints: assessment endpoints and measurement endpoints. Assessment endpoints are environmental characteristics, which, if they are found to be significantly affected, may indicate a need for remediation (e.g., decrease in sports/fisheries). Measurement endpoints are quantitative expressions of an observed or measured effect of the contamination of concern. Measurement endpoints may be identical to assessment endpoints (e.g., measurement of abundance of fish), or they may be used as surrogates for assessment endpoints (e.g., toxicity test endpoints). Both types of endpoints are used in the ecological risk evaluation and are presented in the following sections.

A measurement endpoint, or "ecological effects indicator" as it is sometimes referred, is used to evaluate the assessment endpoint. Therefore, measurement endpoints must correspond to, or be predictive of, assessment endpoints. In addition, they must be readily measurable, preferably quickly and inexpensively, using existing techniques. Measurement endpoints must take into consideration the magnitude of the contamination and the exposure pathway. The measurement endpoint should be an indicator of effects that are temporally distributed. Low natural variability in the endpoint is preferred to aid in attributing the variability in the endpoint to the contaminant. Measurement endpoints should be diagnostic of the pollutants of interest, as well as broadly applicable to allow comparison between sites and regions. Also, measurement endpoints should be standardized (e.g., standard procedures for toxicity tests). Finally, it is desirable to use endpoints that already are being measured (if they exist) to determine baseline conditions.

7.5.1 Aquatic Endpoints

The assessment endpoint for the aquatic receptors is the potential decrease in the aquatic receptor population or subpopulation that is attributable to site-related contaminants. The measurement endpoint is the exceedances of contaminant-specific surface water effect concentrations (i.e., SWSVs).

7.5.2 Terrestrial Endpoints

The assessment endpoint for the terrestrial receptors is the potential reduction of a receptor population or subpopulation that is attributable to contaminants from the site. The measurement endpoints for the terrestrial ERA include exceedances of contaminant-specific soil effect concentrations (i.e., SSSVs) and contaminant-specific effect doses (TRVs).

7.6 Conceptual Model

This section of the ERA presents each potential exposure pathway via soil, groundwater and air, and the likelihood that an exposure will occur through these pathways. Figure 7-1 presents the flowchart of potential exposure pathways and ecological receptors.

To determine if ecological exposure via these pathways may occur in the absence of remedial actions, an analysis is conducted including the identification and characterization of the exposure pathways. The following four elements are examined to determine if a complete exposure pathway is present:

- A source and mechanism of chemical release
- An environmental transport medium
- A feasible receptor exposure route
- A receptor exposure point

7.6.1 Soil Exposure Pathway

Potential release sources to be considered in evaluating the soil pathway are surface or buried wastes and contaminated soil. The release mechanisms to be considered are fugitive dust, leaching, tracking, and surface runoff. The transport medium is the soil. The potential routes to be considered for ecological exposure to the contaminated soil are ingestion and dermal contact. Potential exposure points for ecological receptors include species living in, or coming in contact with, the soil. COPCs were detected in the surface soil demonstrating a release from a source to the surface soil transport medium. Potential receptors that may be exposed to contaminants in surface soil at/or around surface soil in the areas of detected COPCs include the following: deer, fox, raccoon, rabbits, birds, plants, and other terrestrial life.

Terrestrial receptors potentially are exposed to contaminants in the soil through ingestion, dermal contact, and/or direct uptake (for flora). The magnitude of the exposure depends on their feeding habits and the amount of time they reside in the contaminated soil. In addition, terrestrial species may ingest organisms that have bioconcentrated contaminants from the soil. This exposure pathway is likely to occur at Site 54 and will be retained for further analysis.

7.6.2 Groundwater Exposure Pathway

The potential release source to be considered in evaluating the groundwater pathway is contaminated soil. The release mechanism to be considered is leaching. The routes to be considered for ecological exposure to the contaminated groundwater are ingestion and dermal contact.

Sub-surface biota (i.e., microorganisms) are the only ecological receptors expected to be directly exposed to groundwater. Potential impacts to these biota are not assessed in this ERA because current guidance does not provide sufficient information to evaluate risk. However, since surface water samples were not collected at Site 54, contaminants in the groundwater were evaluated as if they were detected in the surface water, with the assumption that the groundwater is discharging to the adjacent water bodies.

Aquatic receptors are exposed to contaminants in the groundwater (after discharging to surface water) by ingesting water while feeding and by direct contact while feeding or swimming. This exposure pathway is likely to occur at Site 54 and will be evaluated in the ERA. In addition, aquatic organisms may ingest other aquatic flora and fauna that have bioaccumulated chemicals from the surface water. This potential exposure pathway will not be evaluated in the ERA because current guidance does not provide sufficient information to evaluate risk.

7.6.3 Air Exposure Pathway

There are two potential release mechanisms to be considered in evaluating the atmospheric pathway: release of contaminated particulates and volatilization from surface soil, groundwater and surface water. The potential exposure points for receptors are areas on or adjacent to the site. The air exposure pathway is not evaluated in this ERA because air sampling was not conducted, and current guidance does not provide sufficient information to evaluate risk to ecological receptors.

7.7 Exposure Assessment

The next phase after the problem formulation is the exposure assessment that consists of quantifying the potential exposure of the stressors (COPCs) to the ecological receptors. The RI included collecting samples for analytical analysis from the soil and groundwater. The analytical results for the data used in ERA are presented in Section 4.0 of this report. The regional ecology, site ecology, and habitat characterization in the areas surrounding Site 54 are presented in Sections 1.0 and 2.0 of this report. Information on sensitive environments and endangered species also is included in this section.

Exposure of contaminants in the surface soil to terrestrial flora and fauna (invertebrates and microorganisms) is assumed to be equal to the contaminant concentration in the surface soil. It is noted in the uncertainty section of this ERA that all the contaminants in the surface soil may not be bioavailable to the terrestrial flora or fauna. Exposure of contaminants in the groundwater to aquatic receptors is assumed to be equal to the contaminant concentration in the groundwater. Exposure of contaminants in the surface soil to other terrestrial fauna (mammals, birds) is estimated using chronic daily intake models (see Section 7.8.5 of this report).

7.8 Ecological Effects Characterization

The ecological effects data that were used to assess potential risks to aquatic and/or terrestrial receptors in this ERA include aquatic and terrestrial screening values (as presented in Section 7.3.2) to aid in the selection of the COPCs. The following sections present a summary of the ecological effects comparison.

7.8.1 Surface Soil

Although promulgated standards do not exist, Surface Soil Screening Values (SSSVs) that can be used to evaluate potential ecological risks to terrestrial flora and fauna have been developed by USEPA Region III (USEPA, 1995b) and Oak Ridge National Laboratory (Will and Suter, 1994a, 1994b). The contaminant concentrations in the surface soils are compared to the SSSVs to determine if potential impacts to terrestrial flora and fauna (invertebrates may be expected (see Table 7-4).

Three SVOCs (n-nitrosodiphenylamine, phenanthrene, pyrene) and three metals (aluminum, chromium, and vanadium) were detected in the surface soil at concentrations exceeding the SSSVs. The SVOCs only slightly exceeded the SSSVs in one (out of eleven) samples. The metals exceeded the SSSVs in all four samples. Much of the study area at Site 54 is grass covered. Therefore, ecological receptors have a high potential for becoming exposed to contaminants in the surface soil.

7.8.2 Groundwater

Contaminant concentrations detected in the groundwater at Site 54 are compared to the freshwater SWSVs to determine if there were any exceedances of the published values (see Tables 7-1). Xylenes, anthracene, naphthalene, aluminum, barium, cobalt, iron, lead, manganese, and nickel are the only contaminants (total) that exceeded any of the SWSVs.

The lowest reported xylenes chronic value for aquatic life is 2,680 $\mu\text{g/L}$ for fish (Suter and Mabrey, 1994). The maximum xylenes concentration in the groundwater (130 $\mu\text{g/L}$) is below the concentration that is expected to cause adverse impacts to fish. Therefore, the SWSVs (1,540-acute, 86.2-chronic) appear to be conservative and overestimate potential risk to aquatic receptors.

The lowest reported naphthalene chronic value for aquatic life is 450 $\mu\text{g/L}$ for fish (Suter and Mabrey, 1994). The maximum naphthalene concentration in the groundwater (240 $\mu\text{g/L}$) is below the concentration that is expected to cause adverse impacts to fish. Also, the USEPA Water Quality Criteria Table (USEPA, 1991b) lists the acute and chronic Lowest Observed Effects Concentration for naphthalene as 2,300 and 620 $\mu\text{g/L}$, respectively. Therefore, the SWSVs (353-acute, 23.4-chronic) appear to be conservative and overestimate potential risk to aquatic receptors.

In the Quality Criteria for Water-1986 (USEPA, 1987), it is reported that soluble barium concentrations in fresh waters generally would have to exceed 50,000 $\mu\text{g/L}$ before toxicity to aquatic life would be expected. In addition, the lowest reported chronic value for aquatic life is 5,800 $\mu\text{g/L}$ for daphnids (Suter and Mabrey, 1994). The maximum barium concentration in the groundwater (68.9 $\mu\text{g/L}$ -total), is below the concentrations that are expected to cause adverse impacts to aquatic life. Therefore, the SWSVs (69.1-acute, 3.8-chronic) appear to be conservative and overestimate potential risk to aquatic receptors.

The lowest reported cobalt chronic value for aquatic life is 5.1 $\mu\text{g/L}$ for daphnids and 290 $\mu\text{g/L}$ for fish (Suter and Mabrey, 1994). The maximum cobalt concentration in the groundwater (20.9 $\mu\text{g/L}$ -total) is below the concentrations that are expected to cause adverse impacts to fish, but above the concentrations that are expected to cause adverse impacts to daphnids.

The SWSVs for manganese (1,470 $\mu\text{g/L}$ -acute, 80.3 $\mu\text{g/L}$ -chronic) were the ORNL aquatic benchmarks. These values also appear to be overly conservative since the lowest chronic value for aquatic organisms (daphnids) is <1,100 $\mu\text{g/L}$, while the lowest chronic value for fish is 1770 $\mu\text{g/L}$. In addition, it is reported in the Quality Criteria for Water-1986 that the tolerance values for aquatic life in freshwaters range from 1,500 $\mu\text{g/L}$ to 1,000,000 $\mu\text{g/L}$ (USEPA, 1987). The maximum manganese concentration in the groundwater samples (1,280 $\mu\text{g/L}$ -total) just slightly exceeded the concentrations that are expected to cause adverse impacts to aquatic life.

In summary, it appears that the SWSVs for xylenes, naphthalene, barium, cobalt, and manganese are very conservative. Toxicity data in other references indicate that potential impacts to aquatic receptors are not expected (or are expected to be low) at the detected concentrations in the groundwater. Potential impacts to aquatic life are expected from anthracene, aluminum, iron, lead, and nickel at the detected concentrations in the groundwater.

7.8.5 Terrestrial Chronic Daily Intake Model

In addition to comparing the soil concentrations to toxicity values for terrestrial invertebrates and plants, a terrestrial Chronic Daily Intake (CDI) Model is used to estimate the exposure of the COPCs to terrestrial receptors. The following describes the procedures used to evaluate the potential soil exposure to terrestrial fauna at Site 54 by both direct and indirect exposure to COPCs via soil, and foodchain transfer.

Based on the regional ecology and potential habitat at the site, the indicator species used in this analysis are the white-tailed deer, cottontail rabbit, red fox, and the bobwhite quail. The exposure points for these receptors are the surface soil, and biota. The routes for terrestrial exposure to the COPCs in the soil are incidental soil ingestion, vegetation (leafy plants, seeds and berries) ingestion, and ingestion of small mammals.

7.8.5.1 Derivation of Terrestrial Reference Value

Total exposure of the terrestrial receptors to the COPCs in the surface soil is determined by estimating the CDI dose and comparing this dose to Terrestrial Reference Values (TRVs) representing acceptable daily doses in mg/kg/day. The TRVs were developed from No-Observed-Adverse-Effect-Levels (NOAELs) or Lowest-Observed-Adverse-Effect-Levels (LOAELs) obtained from the Integrated Risk Information System (IRIS), Agency for Toxic Substances and Disease Registry Toxicological Profiles, mineral tolerance levels of domestic animals (NAS, 1992) or other toxicological data in the literature. Appendix V presents the methodology used in deriving the TRVs and the animals that were used to derive each TRV.

7.8.5.2 Calculation of Chronic Daily Intake

Potential impacts of the terrestrial receptors to the COPCs in the surface soil are determined by estimating the CDI dose and comparing this dose to TRVs representing acceptable daily doses in mg/kg/day. The CDI equations were adapted from those used in Scarano et. al., (1993). The estimated CDI dose of the bobwhite quail, cottontail rabbit, white-tailed deer and small mammal, to soil and vegetation was determined using the following equation:

$$CDI = \frac{[(Cs)(Bv)(Iv) + (Cs)(Is)][H]}{BW}$$

Where:

CDI	=	Chronic Daily Intake, mg/kg/d
Cs	=	Contaminant concentration in soil, mg/kg
Bv	=	Soil to plant transfer coefficient (leaves, stems, straw, etc.), unitless
Iv	=	Rate of vegetation ingestion, kg/d
Is	=	Incidental soil ingestion, kg/d
H	=	Contaminated area/Home area range area ratio, unitless
BW	=	Body weight, kg

To calculate the contaminant concentration in the small mammal, the resulting CDI from the above equation is multiplied by the biotransfer factor for beef (Bb) for organics (Travis and Arms, 1988) and metals (Baes, et. al., 1984).

The estimated CDI dose of the red fox is determined using the following equation:

$$CDI = \frac{(Cs)(Bv)(Iv) + (Cs)(Is) + (Cm)(Im)][H]}{BW}$$

Where:

CDI	=	Chronic Daily Intake, mg/kg/d
Cs	=	Contaminant concentration in soil, mg/kg
Bv	=	Soil to plant transfer coefficient (leaves, stems, straw, etc.), unitless
Iv	=	Rate of vegetation ingestion, kg/d
Is	=	Incidental soil ingestion, kg/d
Cm	=	Contaminant concentrations in small mammals, mg/kg
Im	=	Rate of small mammal ingestion, kg/d
H	=	Contaminated area/Home area range area ratio, unitless
BW	=	Body weight, kg

Bioconcentration of the COPCs to plants is calculated using the soil to plant transfer coefficient (Bv or Br) for organics (Travis and Arms, 1988) and metals (Baes et. al., 1984). The concentrations of the COPCs used in the models were the lower of the upper 95 percent confidence limit or the maximum concentration detected of each COPC. The exposure parameters used in the CDI calculations are presented in Table 7-5.

7.9 Risk Characterization

The risk characterization is the final phase of a risk assessment. It is at this phase that the likelihood of adverse effects occurring as a result of exposure to a stressor is evaluated. This section evaluates the potential decrease in aquatic and terrestrial populations at Site 54 from contaminants identified at the site.

A Quotient Index (QI) approach is used to characterize the risk to aquatic receptors from exposure to contaminants in the surface water (using groundwater values) and to terrestrial receptors from exposure to contaminants in the surface soil. This approach characterizes the potential effects by comparing exposure levels of COPCs in the groundwater to the SWSVs presented in Section 7.8, Ecological Effects Characterization. The QI is calculated as follows:

$$QI = \frac{(EC \text{ or } CDI)}{(SWSV \text{ or } TRV)}$$

Where:	Quotient Index
	EC = Exposure Concentration, µg/L
	CDI = Chronic Daily Intake, mg/kg/day
	SWSV = Surface Water Screening Value, µg/L
	TRV = Terrestrial Reference Value, mg/kg/day

A QI of greater than "unity" is considered to be indicative of potential risk. Such values do not necessarily indicate that an effect will occur but only that a lower threshold has been exceeded. It is important to determine which contaminants are posing the highest risks, in order to evaluate the significance of those contaminants to the site. Therefore, the evaluation of the significance of the QI has been judged as follows: (Menzie et. al., 1993)

- QI exceeds "1" but less than "10": some small potential for environmental effects
- QI exceeds "10": significant potential that greater exposures could result in effects based on experimental evidence
- QI exceeds "100": effects may be expected since this represents an exposure level at which effects have been observed in other species

The risks characterized above provide insight into general effects upon animals and plants in the local population. However, depending on the endpoint selected, they may not indicate if population-level effects will occur.

7.9.1 Groundwater

Table 7-6 presents the groundwater QIs. A hardness of 25 mg/L CaCO₃ was used to calculate the hardness-dependent SWSVs for the total metals (copper and nickel) in Section 7.3.2, since this was the lowest hardness detected at any of the stations. The actual hardness at the stations ranged from 25 to 242 mg/L CaCO₃. Appendix U presents the hardness and surface water QI calculations. Figure 7-2 graphically displays the QIs that exceed "1".

In summary, xylenes, anthracene, naphthalene, aluminum, barium, cobalt, iron, lead, manganese, and nickel are the only COPCs (total) with QIs greater than "1". With the exception of one anthracene sample (QI=769), one aluminum sample (QI=61.4), and one iron sample (QI=74.1), the remaining QIs were less than "20", and most were less than "10".

7.9.2 Terrestrial Chronic Daily Intake Model

Table 7-7 presents the QI for the terrestrial CDI model. Appendix V contains the CDI spreadsheets. The cottontail rabbit (QI= 2.7) was the only species with a QI that exceeded "1". Aluminum (QI=1.62) was the only COPC with an individual QI that exceeded "1" in the cottontail rabbit model.

7.10 Ecological Significance

This section essentially summarizes the overall risks to the ecology at the site. It addresses impacts to ecological receptors at Site 54 from the COPCs detected in the media, and determines which COPCs are impacting the site to the greatest degree, and what "significant" contaminants are site-related. This information, to be used in conjunction with the human health risk assessment, supports the selection of remedial action(s) for Site 54 that are protective of public health and the environment.

7.10.1 Aquatic Receptors

In summary, xylenes, anthracene, naphthalene, aluminum, barium, cobalt, iron, lead, manganese, and nickel are the only COPCs (total) with QIs greater than "1". As presented in Section 7.8.2 (Ecological Effects for Groundwater), the concentration of xylenes and naphthalene are below the concentrations expected to cause a decrease in the aquatic life population. Anthracene only was detected in one out of 17 wells (54-TW05), and at a low concentration (1J µg/L). In addition, anthracene was not detected in any of the perimeter wells, and may not be migrating towards the

surface water. Therefore, a potential decrease in the aquatic life population from anthracene in the groundwater is not expected.

As presented in Section 7.8.2 (Ecological Effects for Groundwater), the concentrations of barium and manganese are below the concentrations expected to cause a decrease in the aquatic life population. In addition, the concentration of cobalt is below the concentration expected to cause a decrease in the fish population. Therefore, aluminum, iron, lead, and nickel are the only metal COPCs with the potential to decrease the population of aquatic life at their detected concentrations. Nickel only exceeded a SWSV in one sample (54-TW02), which was located near the burn pit. Nickel did not exceed a SWSV in any of the perimeter wells. Therefore, a potential decrease in the aquatic life population from nickel in the groundwater is not expected. Aluminum and iron concentrations typically are high at MCB, Camp Lejeune (see Section 4.0), and are not related to past site activities. As such, they are not considered to be site-related.

The highest lead concentration (39.7 μ L) was detected in well 54-GW02, which is upgradient of the burn pit. Lead in the other three wells that exceeded SWSV ranged in concentrations from 2.8 to 4.9 μ L. The lead values for these three samples are based on a hardness of 25 to 27 mg/L CaCO₃. After the groundwater discharges to the adjacent creek, it is likely that the concentration of lead will decrease (provided that the lead is detected at a lower concentration in the surface water). Therefore, it is not expected that the lead in the groundwater will cause a significant decrease in the aquatic population after it discharges to the adjacent water bodies. In addition,

7.10.2 Terrestrial Receptors

Three SVOCs (n-nitrosodiphenylamine, phenanthrene, and pyrene) in one sample each, and three metals (aluminum, chromium, and vanadium) in four samples, exceeded the SSSVs. All the surface soil samples that had contaminants that exceeded the SSSVs were collected from the drainage ditches adjacent to the burn pit. Therefore, there is a potential for adverse impacts to terrestrial flora, invertebrates, and/or microorganisms from these contaminants. It should be noted that these ditches are dry (except during periods of rain), and covered with grass or exposed soil. This type of habitat, along with the surrounding habitat (mowed field), is not expected to support an ecologically diverse terrestrial population.

The cottontail rabbit (QI=2.7) was the only terrestrial vertebrate with a CDI QI that exceeded "1". Due to the location of the surface soil samples with the highest detections (in the drainage ditch), and the relatively low QI value, it is unlikely that the contaminants in the surface soil at Site 54 will significantly reduce the rabbit population.

7.10.3 Threatened and Endangered Species

No threatened or endangered species are expected to occur at Site 54.

7.10.4 Wetlands

No wetlands were observed at Site 54 during the field investigations.

7.11 Uncertainty Analysis

The procedures used in this evaluation to assess risks to ecological receptors, as in all such assessments, are subject to uncertainties. The following discusses some of the uncertainty in this ERA.

There is uncertainty in the ecological endpoint comparison. The SWSVs (WQS and AWQC) are established to be protective of a majority of the potential receptors. However, some species may not be protected by the values because of their increased sensitivity to the chemicals. In addition, most of the values are established using laboratory tests, where the concentrations of certain water quality parameters (pH, hardness, total organic carbon) that may influence toxicity are most likely at different concentrations in the site water.

As presented earlier in the ERA, since surface water samples were not collected from adjacent water bodies, contaminants in the groundwater were compared to the SWSVs. This is extremely conservative since it does not account for any mixing with the receiving water. In addition, there may be different concentrations of water quality parameters (see above) in the receiving water than in the groundwater.

Potential adverse impacts to terrestrial invertebrates and plants were evaluated by comparing the COPC concentration in the soil to SSSVs. Most of these studies do not account for the soil type, which may have a large influence on the toxicity of the contaminants. For example, soil with high organic carbon content will tend to sorb many of the organic COPCs, thus making them less bioavailable to terrestrial receptors. In addition, most of the SSSVs are based on one or two studies, which greatly adds to their uncertainty.

There are some differences of opinion found in the literature as to the effectiveness of using models to predict concentrations of contaminants found in terrestrial species. According to one source, the food chain models currently used incorporate simplistic assumptions that may not represent actual site conditions, bioavailability of contaminants, or site-specific behavior of the receptors. Simple food chain models can provide an effective means of initial characterization of risk, however, residue analyses, toxicity tests, and the use of biomarkers provide a better approach for assessing exposure (Menzie et. al., 1993).

There are several sources of uncertainty when using these models. First, most of the terrestrial reference values are based on toxicity data from another species, which is then extrapolated to the species of concern using a body-size scaling equation. Since the toxicity of all contaminants may not be proportional to body size, the calculated TRVs may not accurately predict risk to the species of concern. Another source of uncertainty with the models is that many of the input parameters are based on default values (i.e., ingestion rate) that may or may not adequately represent the actual values of the parameters. In addition, there is uncertainty in the amount that the indicator species will represent other species potentially exposed to COPCs at the site. There is uncertainty in use of the bioconcentration and biotransfer factors. Bioconcentration and biotransfer factors can vary widely from species to species. The species used in the calculation of the bioconcentration and biotransfer factors are different than the species that actually occur at the site. Therefore, use of the factors will tend to either overestimate or underestimate actual bioaccumulation of contaminants. Finally, terrestrial receptors also may be exposed to contaminants in the sediments. However, currently, there is no guidance in the literature that can be used to evaluate this potential exposure pathway.

The toxicity of chemical mixtures is not well understood. All the toxicity information used in the ERA for evaluating risk to the ecological receptors is for individual chemicals. Chemical mixtures can affect the organisms very differently than the individual chemicals due to synergistic or antagonistic effects. In addition, the species that were used to develop the toxicity data may not be present at the site, or have the potential to exist at the site. Depending on the sensitivity of the tested species to the species at the site use of the toxicity values may overestimate or underestimate risk. Many chemicals are not acutely toxic, however, they have the potential to bioaccumulate in ecological receptors through food chain transfer. This bioaccumulation potential typically is not taken into account when comparing contaminant concentrations to screening values.

Finally, toxicological data for several of the COPCs were limited or do not exist. Therefore, there is uncertainty in any conclusions involving the potential impacts to aquatic receptors from these contaminants

7.12 Conclusions

This section of the ERA evaluates the assessment endpoints using the selected measurement endpoints.

7.12.1 Aquatic Receptors

As presented earlier in the ERA, the assessment endpoint for the aquatic receptors is the potential decrease in the aquatic receptor population or subpopulation that is attributable to site-related contaminants. The measurement endpoint is to determine if the contaminant concentrations in the ground water exceed the contaminant-specific surface water effect concentrations (i.e., SWSVs). Several contaminants (xylenes, anthracene, naphthalene, aluminum, barium, cobalt, iron, lead, manganese, and nickel) in the groundwater were detected at concentrations that potentially may cause a decrease in the aquatic population if they were detected at similar concentrations in surface water.

Anthracene and nickel only exceeded the SWSVs in one out of 17 wells; neither COPC exceeded the SWSV in a perimeter well. Xylenes, naphthalene, barium, and manganese while exceeding the screening values, were detected below the concentrations that are expected to cause a decrease in aquatic life using other toxicity data. Aluminum and iron are not considered to be site-related. Finally, lead exceeded the SWSVs in three wells, with the highest concentration being detected in an upgradient well. Due to the low hardness values used to calculate the SWSVs, and the expected dilution after discharging to the receiving water, the potential decrease in the aquatic life population from lead in the groundwater is expected to be low. In addition, there is a low potential for the remaining COPCs to cause a decrease in the aquatic life population after discharging to the water bodies.

7.12.2 Terrestrial Receptors

As presented earlier in the ERA, the assessment endpoint for the terrestrial receptors is the potential reduction of a receptor population or subpopulation that is attributable to contaminants from the site.

The first measurement endpoint is to determine if there are any exceedances of contaminant-specific soil effect concentrations (i.e., SSSVs). Three SVOCs and three metals (n-nitrosodiphenylamines,

phenanthrene, pyrene, aluminum, chromium, and vanadium) exceeded the SSSVs. Therefore, there is a potential for adverse impacts to terrestrial flora, invertebrates, and/or microorganisms from these contaminants. It should be noted that the habitat where these exceedences were located (mowed grass and exposed soil in the drainage ditch), along with the surrounding habitat (mowed field), are not expected to support an ecologically diverse population.

The second measurement endpoint is to determine if the terrestrial CDI exceeds the TRVs. The cottontail rabbit is the only terrestrial species with estimated CDI values that exceeded the TRV values. Due to the location of the surface soil samples with the highest detections (the drainage ditch), and the relatively low QI value, it is unlikely that the contaminants in the surface soil at Site 54 will significantly reduce the rabbit population.

Overall, some potential impacts to soil invertebrates and plants may occur as a result of site-related contaminants. It should be noted that there is much uncertainty in the SSSVs. A potential decrease in the terrestrial vertebrate population from site-related contaminants is not expected based on the terrestrial intake model.

7.13 References

Agency for Toxic Substances and Disease Registry (ASTDR). 1991. Toxicological Profile for N-Nitrosodiphenylamine, Draft. Prepared by Clement Associates for the US Department of Health and Human Services.

Agency for Toxic Substances and Disease Registry (ASTDR). 1989. Toxicological Profile for Naphthalene/2-methynaphthalene - Draft. Prepared by Life Systems, Inc, for the US Department of Health and Human Services.

Arthur and Alldredge. 1979. Public Health Evaluation and Ecological Assessment. Martin Marrietta Astronautics Group, Waterton Facility, Vol. II of III, Appendix A and B. Cited in Scarano, 1993.

Baes, C.F., Sharp, A.L., and R.W. Shor. "September 1984. "Review and Analysis of Parameters for Assessing Transport of Environmentally Released Radionuclides through Agriculture." Oak Ridge National Laboratory.

Beyer, N., E. Connor, and S. Gerould. 1993. "Estimates of Soil Ingestion by Wildlife". Patuxent Wildlife Research Center, Laurel, MD.

Dee, J.C. November, 1991. "Methodology For Assessing Potential Risks To Deer Populations: A Case Study at a Superfund Site". Paper presented at the 1991 Annual Meeting of the Society of Environmental Toxicology and Chemistry. Abstract No. 426.

Menzie, C.A., Cura J. and J. Freshman. January 1993. Evaluating Ecological Risks and Developing Remedial Objectives at Forested Wetland Systems in New England. Paper contained in: Application of Ecological Risk Assessment To Hazardous Waste Site Remediation. Water Environmental Federation.

Montgomery, J.H. and L.M. Welkon. 1990. Groundwater Chemicals Desk Reference. Lewis Publishers, Inc. Chelsea, Michigan.

Nagy, Kenneth. 1987. "Field Metabolic Rate and Food Requirement Scaling in Mammals and Birds. Ecological Monographs." 57(2). pp. 111-128.

NAS. 1992. Subcommittee on Mineral Toxicity in Animals. Mineral Tolerance of Domestic Animals. National Academy of Sciences. Washington, D.C.

NC DEHNR. 1994. 15A NCAC 2b.0200 - Classifications and Water Quality Standards Applicable to Surface Waters of North Carolina. State of North Carolina Department of Health and Natural Resources. June 1, 1994.

Opresko, D.M., B.E. Sample, and G.W. Suter II. 1994. Toxicological Benchmarks for Wildlife, 1994 Revisions. Prepared for the US Department of Energy, Office of Environmental Restoration and Waste Management. September, 1994. ES/ER/TM-86/R1.

SCDM. 1991. Superfund Chemical Data Matrix. United States Environmental Protection Agency Hazardous Site Evaluation Division. December 1991.

Scarano, Louis, J. Ph.D. and Daniel M. Woltering, Ph.D. January 1993. "Terrestrial and Aquatic Eco-Assessment for A RCRA Hazardous Waste Site". Paper contained in: Application of Ecological Risk Assessment To Hazardous Waste Site Remediation. Cited in WEF, 1993.

Suter, G.W. II. and J.B. Mabrey. 1994. Toxicological Benchmarks for Screening Potential Contaminants of Concern for Effects on Aquatic Biota: 1994 Revision. Environmental Sciences Division, Oak Ridge National Laboratory.

Travis, Curtis C. and Angela Arms. 1988. Bioconcentration of Organics in Beef, Milk, and Vegetation. Environmental Science Technology. Vol. 22, No. 3.

USEPA, U.S. Environmental Protection Agency. January 26, 1995a. "Toxic Substance Spreadsheet". Region IV, Atlanta, Georgia.

USEPA, U.S. Environmental Protection Agency. January 19, 1995b. "Region III BTAG Screening Levels". Region III, Philadelphia, PA.

USEPA, U.S. Environmental Protection Agency. September 26, 1994a. Ecological Risk Assessment Guidance for Superfund: Process for Designing and Conducting Ecological Risk Assessments. Review Draft Environmental Response Team, Edison NJ

USEPA, US Environmental Protection Agency. September 1993a. Sediment Quality Criteria for the Protection of Benthic Organisms- Fluoranthene. Office of Science and Technology. Health and Ecological Criteria Section. Washington, D.C. EPA-822-R-93-012.

USEPA, US Environmental Protection Agency. September 1993b. Sediment Quality Criteria for the Protection of Benthic Organisms- Phenanthrene. Office of Science and Technology. Health and Ecological Criteria Section. Washington, D.C. EPA-822-R-93-014.

USEPA, U.S. Environmental Protection Agency. December 1993c. Wildlife Exposure Factors Handbook. Office of Research and Development. Washington, D.C. EPA/600/R-93/187a.

USEPA. U.S. Environmental Protection Agency. February 1992a. Framework for Ecological Risk Assessment. United States Environmental Protection Agency. Risk Assessment Forum. EPA/630/R-92/001.

USEPA, U.S. Environmental Protection Agency. December 1992b. 40 CFR Part 131, Water Quality Standards; Establishment of Numeric Criteria for Priority Toxic Pollutants; States' Compliance; Final Rule. Federal Register Notice, December 22, 1995, pgs. 60847-60923.

USEPA, U.S. Environmental Protection Agency. June 1991a. National Functional Guidelines for Organic Data Review. Draft. USEPA Contract Laboratory Program.

USEPA, U.S. Environmental Protection Agency. May 1, 1991b. "Water Quality Criteria Summary" (Wall Chart). Office of Science and Technology. Health and Ecological Criteria Section. Washington, D.C.

USEPA. U.S. Environmental Protection Agency. March 1989a. Risk Assessment Guidance for Superfund Volume II. Environmental Evaluation Manual Interim Final. Office of Solid Waste and Emergency Response. Washington, D.C. EPA/540/1-89-001.

USEPA. U.S. Environmental Protection Agency. March 1989b. Ecological Assessment of Hazardous Waste Sites: A Field and Laboratory Reference. Environmental Research Laboratory, Corvallis, OR. EPA/600/3-89/013.

USEPA. U.S. Environmental Protection Agency. December 1989c. Risk Assessment Guidance for Superfund, Volume I. Human Health Evaluation Manual (Part A). Interim Final EPA/540/1-89/002.

USEPA. U.S. Environmental Protection Agency. May 1987. Quality Criteria for Water-1986. Office of Water Regulations.

USEPA. U.S. Environmental Protection Agency. October 1986. Chemical, Physical, and Biological Properties of Compounds Present at Hazardous Waste Sites. Office of Solid Waste and Remedial Response. Washington D.C. EPA/540/1-86/060.

Water Environment Federation (WEF). 1989. Application of Ecological Risk Assessment to Hazardous Waste Site Remediation. Based on a January 10, 1993 Workshop., 601 Wythe Street, Alexandria, VA 22314-1994.

Will, M.E. and Suter, G.W. II. 1994a. Toxicological Benchmarks for Screening Potential Contaminants of Concern for Effects on Soil and Litter Invertebrates and Heterotrophic Process. Environmental Sciences Division, Oak Ridge National Laboratory.

Will, M.E. and Suter, G.W. II. 1994b. Toxicological Benchmarks for Screening Potential Contaminants of Concern for Effects on Terrestrial Plants. Environmental Sciences Division, Oak Ridge National Laboratory.

SECTION 7.0 TABLES

TABLE 7-1

FREQUENCY AND RANGE OF CONTAMINANT DETECTIONS IN GROUNDWATER
 COMPARED TO SURFACE WATER SCREENING VALUES
 SITE 54, CRASH CREW FIRE TRAINING BURN PIT
 REMEDIAL INVESTIGATION CTO-0303
 MCAS, NEW RIVER, NORTH CAROLINA

Contaminant	Surface Water Screening Values (SWSV)		Contaminant Frequency/Range		No. of Positive Detects Above Lowest SWSV	
	North Carolina Water Quality Standards (WQS) ⁽¹⁾	USEPA Region IV Water Quality Screening Values (WQSV) ⁽²⁾		No. of Positive Detects/No. of Samples		Range of Positive Detects
		Acute	Chronic			
Volatiles (µg/L)						
Benzene	NA	815 ⁽⁴⁾	45.5 ⁽⁴⁾	6/17	5J-40	0
Carbon disulfide	NA	159 ⁽⁴⁾	8.89 ⁽⁴⁾	1/17	4J	0
Ethylbenzene	NA	6,970 ⁽⁴⁾	389 ⁽⁴⁾	3/17	6J-26	0
1,2-Dichloroethene	NE	11,600 ⁽⁴⁾	NE	3/17	5J-23	0
Toluene	11	3,150 ⁽⁴⁾	176 ⁽⁴⁾	2/17	22-83	0
Trichloroethene	NA	4,350 ⁽⁴⁾	465 ⁽⁴⁾	1/17	1J	0
Xylenes (total)	NA	1,540 ⁽⁴⁾	86.2 ⁽⁴⁾	3/17	27-130	1
Semivolatiles (µg/L)						
Anthracene	NA	0.024 ⁽⁴⁾	0.0013 ⁽⁴⁾	1/17	1J	1
Bis(2-ethylhexyl)phthalate	NA	286 ⁽⁴⁾	32.2 ⁽⁴⁾	2/17	1J	0
Diethylphthalate	NA	3,950 ⁽⁴⁾	220 ⁽⁴⁾	5/17	1J-37J	0
2,4-Dimethylphenol	NA	NA	NA	1/17	3J	NA
Di-n-butylphthalate	NA	234 ⁽⁴⁾	32.7 ⁽⁴⁾	2/17	1J-2J	0
2-Methylnaphthalene	NA	NA	NA	6/17	1J-160	NA
Naphthalene	NA	353 ⁽⁴⁾	23.4 ⁽⁴⁾	7/17	1J-240	5
Nitrobenzene	NA	NA	NA	1/17	2J	NA
Phenol	NA	2,010 ⁽⁴⁾	117 ⁽⁴⁾	1/17	1J	0
Inorganics (µg/L)						
Aluminum	NE	750	87	3/13	206-5,340	3
Arsenic	50	360	190	4/13	2.8-24.7	0

TABLE 7-1 (Continued)

FREQUENCY AND RANGE OF CONTAMINANT DETECTIONS IN GROUNDWATER
 COMPARED TO SURFACE WATER SCREENING VALUES
 SITE 54, CRASH CREW FIRE TRAINING BURN PIT
 REMEDIAL INVESTIGATION CTO-0303
 MCAS, NEW RIVER, NORTH CAROLINA

Contaminant	Surface Water Screening Values (SWSV)		Contaminant Frequency/Range		No. of Positive Detects Above Lowest SWSV	
	North Carolina Water Quality Standards (WQS) ⁽¹⁾	USEPA Region IV Water Quality Screening Values (WQSV) ⁽²⁾		No. of Positive Detects/No. of Samples		Range of Positive Detects
		Acute	Chronic			
Barium	NE	69.1 ⁽⁴⁾	3.8 ⁽⁴⁾	12/13	26.3-68.9	12
Calcium	NE	NE	NE	13/13	3,230-91,500	NA
Chromium	50	558 ⁽³⁾	67 ⁽³⁾	1/13	10.3	0
Cobalt	NE	195 ⁽⁴⁾	3.06 ⁽⁴⁾	4/13	5.9-20.9	4
Iron	1,000	NE	1,000	12/13	193J-74,100	7
Lead	25	13.98 ⁽³⁾	0.54 ⁽³⁾	5/13	1.9-39.7	5
Magnesium	NE	NE	NE	13/13	1,430-6,550	NA
Manganese	NE	1,470 ⁽⁴⁾	80.3 ⁽⁴⁾	13/13	25.5-1,280	9
Nickel	88	439 ⁽³⁾	49 ⁽³⁾	4/13	14.1-61.6	1
Potassium	NE	NE	NE	8/13	885-3,960	NA
Sodium	NE	NE	NE	13/13	3,390-27,800	NA
Zinc	50	36 ⁽³⁾	33 ⁽³⁾	3/13	8.2-24.7	0

Notes:

NE = Not Established

NA = Not Applicable

⁽¹⁾ NCDEHNR, 1994 (Water Quality Standards)

⁽²⁾ USEPA, 1995a (Region IV Toxic Substance Spreadsheet)

⁽³⁾ Criteria are hardness dependent; values are based on a hardness of 25 mg/L as CaCO₃

⁽⁴⁾ Suter and Mabrey, 1994 (Toxicological Benchmarks for Screening Potential COCs for Effects on Aquatic Biota)

TABLE 7-2

CONTAMINANTS OF POTENTIAL CONCERN IN EACH MEDIA
 SITE 54, CRASH CREW FIRE TRAINING BURN PIT
 REMEDIAL INVESTIGATION CTO-0303
 MCAS, NEW RIVER, NORTH CAROLINA

Contaminant	Aquatic receptors	Surface Soil
Volatiles		
Xylenes	X	
Semivolatiles		
Anthracene	X	
Bis(2-ethylhexyl)phthalate		X
Butylbenzylphthalate		X
2,4-Dimethylphenol	X	
Di-n-octylphthalate		X
Fluoranthene		X
2-Methylnaphthalene	X	
Naphthalene	X	
Nitrobenzene	X	
N-nitrosodiphenylamine		X
Phenanthrene		X
Pyrene		X
Inorganics		
Aluminum	X	X
Barium	X	X
Chromium		X
Cobalt	X	
Iron	X	
Lead	X	
Manganese	X	X
Nickel	X	
Vanadium		X
Zinc		X

TABLE 7-3

**PHYSICAL/CHEMICAL CHARACTERISTICS OF THE COPCs
SITE 54, CRASH CREW FIRE TRAINING BURN PIT
REMEDIAL INVESTIGATION, CTO 303
MCAS, NEW RIVER, NORTH CAROLINA**

Contaminant of Potential Concern	BCF	Organic Carbon Partition Coefficient (mL/g)	Log Octanol/Water Coefficient	Biotransfer Factors		
				B _v ⁽¹⁾⁽²⁾	B _r ⁽¹⁾⁽²⁾	B _b ⁽¹⁾⁽²⁾
Volatiles						
Xylenes	2.20 ⁽⁴⁾	240 ⁽⁵⁾	3.20 ⁽⁶⁾	5.48e-01	5.48e-01	3.98e-05
Semivolatiles						
Anthracene	30 ⁽³⁾	14,000 ⁽⁵⁾	4.5 ⁽⁶⁾	9.70e-02	9.70e-02	7.94e-04
Bis(2-ethylhexyl)phthalate	130 ⁽³⁾	100,000 ⁽⁷⁾	5.1 ⁽⁶⁾	4.40e-02	4.40e-02	3.16e-03
Butylbenzylphthalate	414 ⁽³⁾	ND	4.9 ⁽⁶⁾	5.70e-02	5.70e-02	2.00e-03
2,4-Dimethylphenol	93.8 ⁽³⁾	117 ⁽⁷⁾	2.5 ⁽⁶⁾	1.39e+00	1.39e+00	7.94e-06
Di-n-octylphthalate	890 ⁽³⁾	977,237,221 ⁽⁷⁾	9.3 ⁽⁶⁾	1.86e-04	1.86e-04	3.98e+01
Fluoranthene	1,150 ⁽³⁾	100,000 ⁽⁹⁾	5.1 ⁽⁹⁾	4.40e-02	4.40e-02	3.90e-03
2-Methylnaphthalene	10.5 ⁽⁸⁾	1,072 ⁽⁸⁾	3.6 ⁽⁸⁾	3.22e-01	3.22e-01	1.00e-04
Naphthalene	10.5 ⁽³⁾	1,072 ⁽¹⁰⁾	3.6 ⁽⁶⁾	3.22e-01	3.22e-01	1.00e-04
Nitrobenzene	2.9 ⁽³⁾	36 ⁽⁵⁾	1.9 ⁽⁶⁾	3.09e+00	3.09e+00	2.00e-06
N-nitrosodiphenylamine	136 ⁽³⁾	832 ⁽¹²⁾	3.1 ⁽⁶⁾	6.25e-01	6.25e-01	3.16e-05
Phenanthrene	30 ⁽³⁾	28,840 ⁽¹¹⁾	4.5 ⁽¹¹⁾	9.70e-02	9.70e-02	7.94e-04
Pyrene	30 ⁽³⁾	38,000 ⁽⁵⁾	5.3 ⁽⁶⁾	3.30e-02	3.30e-02	5.01e-03
Inorganics						
Aluminum	231 ⁽⁴⁾	ND	ND	4.00e-03	6.50e-04	1.50e-03
Barium	8 ⁽⁴⁾	ND	ND	1.50e-01	1.50e-02	1.50e-04
Chromium	16 ⁽³⁾	ND	ND	7.50e-03	4.50e-03	5.50e-03
Cobalt	40 ⁽⁴⁾	ND	ND	2.00e-02	7.00e-03	2.00e-02
Iron	ND	ND	ND	4.00e-03	1.00e-03	2.00e-02
Lead	49 ⁽³⁾	ND	ND	4.50e-02	9.00e-03	3.00e-04
Manganese	35 ⁽⁴⁾	ND	ND	2.50e-01	5.00e-02	4.00e-04
Nickel	47 ⁽³⁾	ND	ND	6.00e-02	6.00e-02	6.00e-03
Vanadium	ND	ND	ND	5.50e-03	3.00e-03	2.50e-03
Zinc	47 ⁽³⁾	ND	ND	1.50e+00	9.00e-01	1.00e-01

TABLE 7-3 (Continued)

PHYSICAL/CHEMICAL CHARACTERISTICS OF THE COPCs
SITE 54, CRASH CREW FIRE TRAINING BURN PIT
REMEDIAL INVESTIGATION, CTO-0303
MCAS, NEW RIVER, NORTH CAROLINA

Notes:

- (1) Baes *et.al*, 1984 for the inorganics
 - (2) The organics were calculated using Travis and Arms, 1988
 - (3) USEPA, 1995b (Region IV)
 - (4) USEPA, 1995a (Region III)
 - (5) USEPA, 1986.
 - (6) SCDM, 1991.
 - (7) Montgomery and Welkon, 1990.
 - (8) Used naphthalene values
 - (9) USEPA, 1993a (Sediment Quality Criteria for Fluoranthene)
 - (10) ASTDR, 1989 (Toxicological Profile for Naphthalene/2-Methynaphthalene)
 - (11) USEPA, 1993b (Sediment Quality Criteria for Phenanthrene)
 - (12) ASTDR, 1991 (n-Nitrosodiphenylamine)
- BCF = Bioconcentration Factor
ND = No Data
Bv = Biotransfer factor for vegetation (stems, leaves)
Br = Biotransfer factor for vegetation (berries, fruits)
Bb = Biotransfer factor for beef

TABLE 7-4

**FREQUENCY AND RANGE OF CONTAMINANT DETECTIONS
 COMPARED TO SOIL FLORA AND FAUNA SCREENING VALUES
 SITE 54, CRASH CREW FIRE TRAINING BURN PIT
 REMEDIAL INVESTIGATION CTO-0303
 MCAS, NEW RIVER, NORTH CAROLINA**

Contaminant	Soil Flora and Fauna Screening Values ⁽¹⁾				Contaminant Frequency/Range		No. of Positive Detects Above Lowest Screening Value
	Plant	Earthworm	Invertebrate	Microorganisms and Microbial Processes	No. of Positive Detects/No. of Samples	Range of Positive Detections	
Semivolatiles (µg/kg)							
Bis(2-ethylhexyl)phthalate	NE	NE	NE	NE	6/11	59J-820	NA
Butylbenzylphthalate	NE	NE	NE	NE	2/11	50J-320J	NA
Di-n-octylphthalate	NE	NE	NE	NE	1/11	150J	NA
Fluoranthene	NE	100 ⁽²⁾	100 ⁽²⁾	NE	2/11	62J-67J	0
N-Nitrosodiphenylamine	NE	20	NE	NE	1/11	160J	1
Phenanthrene	NE	100 ⁽²⁾	100 ⁽²⁾	NE	2/11	98J-120J	1
Pyrene	NE	100 ⁽²⁾	100 ⁽²⁾	NE	2/11	99J-150J	1
Inorganics (mg/kg)							
Aluminum	50	NE	NE	600	4/4	4,680-6,930	4
Barium	500	440 ⁽²⁾	440 ⁽²⁾	3,000	4/4	12.3-26.9	0
Chromium	1	0.4	0.0075 ⁽²⁾	10	4/4	5.7-9.1	4
Manganese	500	330 ⁽²⁾	330 ⁽²⁾	100	4/4	10.5-23.9	0
Vanadium	2	58 ⁽²⁾	58 ⁽²⁾	20	4/4	7-11.8	4
Zinc	50	200	500	100	4/4	8.3-16.7	0

Notes:

- (1) Will and Suter, 1994a and 1994b unless indicated otherwise (Values presented for plants, earthworms, and microorganisms and microbial processes are benchmarks below which adverse impacts to these species are not expected. Values for invertebrates are No Observed Effects Concentrations, however, they are based on less data than the benchmarks)
- (2) USEPA, 1995b (Region III BTAG Soil Screening Values for Soil Fauna)

TABLE 7-5

EXPOSURE PARAMETERS FOR CHRONIC DAILY INTAKE MODEL
 SITE 54, CRASH CREW FIRE TRAINING BURN PIT
 REMEDIAL INVESTIGATION CTO-0303
 MCAS, NEW RIVER, NORTH CAROLINA

Exposure Parameter	Units	White-Tailed Deer	Eastern Cottontail Rabbit	Bobwhite Quail	Red Fox	Small Mammal (Meadow Vole)
Food Source Ingestion	NA	Vegetation 100%	Vegetation 100%	Vegetation 100%	Small Mammals 80% Vegetation 20%	Vegetation 100%
Feeding Rate	kg/day	1.6 ⁽²⁾	0.237 ⁽⁴⁾	0.0135 ⁽³⁾	0.601 ⁽³⁾	0.112 ⁽³⁾
Incident Soil Ingestion	kg/day	0.0185 ⁽¹⁾	0.0057 ⁽⁵⁾	0.0011 ⁽⁵⁾	0.0168 ⁽⁵⁾	0.00269 ⁽⁵⁾
Rate of Drinking Water Ingestion	L/day	1.1 ⁽²⁾	0.119 ⁽³⁾	0.0191 ⁽³⁾	0.385 ⁽³⁾	0.0652 ⁽³⁾
Rate of Vegetation Ingestion	kg/day	1.6	0.237	0.0135	0.12	0.112
Body Weight	kg	45.4 ⁽²⁾	1.229 ⁽³⁾	0.174 ⁽³⁾	4.54 ⁽³⁾	0.3725 ⁽³⁾
Rate of Small Mammal Ingestion	kg/day	NA	NA	NA	0.48	NA
Rate of Fish Ingestion	kg/day	NA	NA	NA	NA	NA
Home Range Size	acres	454 ⁽²⁾	9.30 ⁽³⁾	26.24 ⁽³⁾	1,245 ⁽³⁾	0.032 ⁽³⁾

Notes:

NA = Not Applicable

(1) Arthur and Alldridge, 1979

(2) Dee, 1991

(3) USEPA, 1993c

(4) Opresko, et.al., 1994

(5) Beyer, 1993

(6) Nagy, 1987

TABLE 7-6

**GROUNDWATER QUOTIENT INDEX
SITE 54, CRASH CREW FIRE TRAINING BURN PIT
REMEDIAL INVESTIGATION CTO-0303
MCAS, NEW RIVER, NORTH CAROLINA**

Contaminant	Monitoring Well	Concentration (µg/L)	Quotient Index		
			North Carolina WQS	USEPA SWSV	
				Acute	Chronic
Volatiles					
Xylenes (total)	54-TW03	130	NA	0.1	1.5
Semivolatiles					
Anthracene	54-TW05	11	NA	41.7	769.2
Naphthalene	54-GW06	55	NA	0.2	2.4
	54-TW02	100	NA	0.3	4.3
	54-TW03	240	NA	0.7	10.3
	54-TW04	56	NA	0.2	2.4
	54-TW05	99	NA	0.3	4.2
Inorganics					
Aluminum	54-GW01	206	NA	0.3	2.4
	54-GW04	219	NA	0.3	2.5
	54-GW10	5340	NA	7.1	61.4
Barium	54-GW01	36.4	NA	0.5	9.6
	54-GW02	26.3	NA	0.4	6.9
	54-GW03	28.5	NA	0.4	7.5
	54-GW04	39.6	NA	0.6	10.4
	54-GW05	68.9	NA	0.997	18.1
	54-GW06	43.1	NA	0.6	11.3
	54-GW07	27.2	NA	0.4	7.2
	54-GW08	30.2	NA	0.4	7.9
	54-GW09	43.6	NA	0.6	11.5
	54-GW10	40.6	NA	0.6	10.7
	54-TW01	59.5	NA	0.9	15.7
	54-TW02	29.2	NA	0.4	7.7
Cobalt	54-GW01	11.3	NA	0.1	3.7
	54-GW03	17.6	NA	0.1	5.3
	54-GW04	5.9	NA	0.0	1.9
	54-GW06	20.9	NA	0.1	6.3

TABLE 7-6 (Continued)

GROUNDWATER QUOTIENT INDEX
 SITE 54, CRASH CREW FIRE TRAINING BURN PIT
 REMEDIAL INVESTIGATION CTO-0303
 MCAS, NEW RIVER, NORTH CAROLINA

Contaminant	Monitoring Well	Concentration (µg/L)	Quotient Index		
			North Carolina WQS	USEPA SWSV	
				Acute	Chronic
Iron	54-GW01	3620J	3.6	NA	3.6
	54-GW02	13100J	13.1	NA	13.1
	54-GW03	16800J	16.8	NA	16.8
	54-GW06	1570J	1.6	NA	1.6
	54-GW10	5000	5.0	NA	5.0
	54-TW02	7510	7.5	NA	7.5
	54-TW03	74100	74.1	NA	74.1
Lead	54-GW01	2.8	0.1	0.3	7.4
	54-GW02	39.7	1.6	0.3	7.5
	54-GW06	4.9	0.2	0.5	12.6
	54-GW10	3.9	0.2	0.3	6.5
Manganese	54-GW01	640	NA	0.4	8.0
	54-GW03	1280	NA	0.9	15.9
	54-GW04	132	NA	0.1	1.6
	54-GW05	135	NA	0.1	1.7
	54-GW06	1160	NA	0.8	14.4
	54-GW08	89.9	NA	0.1	1.1
	54-GW09	349	NA	0.2	4.3
	54-GW10	89.3	NA	0.1	1.1
Nickel	54-TW02	61.6	0.7	0.1	1.2

Notes:

Shaded Samples are Quotient Indices That Exceed "1"

NE = Not Established

WQS = Water Quality Standard

SWSV = Surface Water Screening Value

TABLE 7-7

TERRESTRIAL INTAKE MODEL QUOTIENT INDICES
 SITE 54, CRASH CREW FIRE TRAINING BURN PIT
 REMEDIAL INVESTIGATION, CTO-0303
 MCAS, NEW RIVER, NORTH CAROLINA

Contaminant of Potential Concern	Red Fox	Bobwhite Quail	Cottontail Rabbit	Whitetail Deer
Bis(2-ethylhexyl)phthalate	6.14e-05	2.68e-04	1.43e-02	1.45e-04
Butylbenzylphthalate	7.83e-07	1.20e-05	2.03e-04	2.14e-06
Di-n-octylphthalate	2.59e-06	3.58e-06	3.05e-05	1.84e-07
Fluoranthene	5.22e-07	7.79e-06	1.22e-04	1.24e-06
Phenanthrene	1.62e-07	2.66e-06	5.21e-05	5.82e-07
Pyrene	1.84e-06	2.66e-05	3.83e-04	3.74e-06
n-Nitrosodiphenylamine	5.70e-07	1.15e-05	3.05e-04	3.73e-06
Aluminum	5.07e-03	2.69e-01	1.62e+00	6.00e-03
Barium	7.26e-03	2.82e-02	3.90e-01	1.21e-02
Chromium	1.30e-04	7.35e-05	4.78e-04	9.65e-06
Manganese	2.47e-04	3.58e-04	2.73e-02	1.74e-03
Vanadium	6.16e-04	3.25e-04	5.80e-01	2.24e-04
Zinc	2.32e-03	2.38e-03	8.48e-02	2.81e-03
Total Quotient Index	1.57e-02	3.01e-01	2.71e+00	2.30e-02

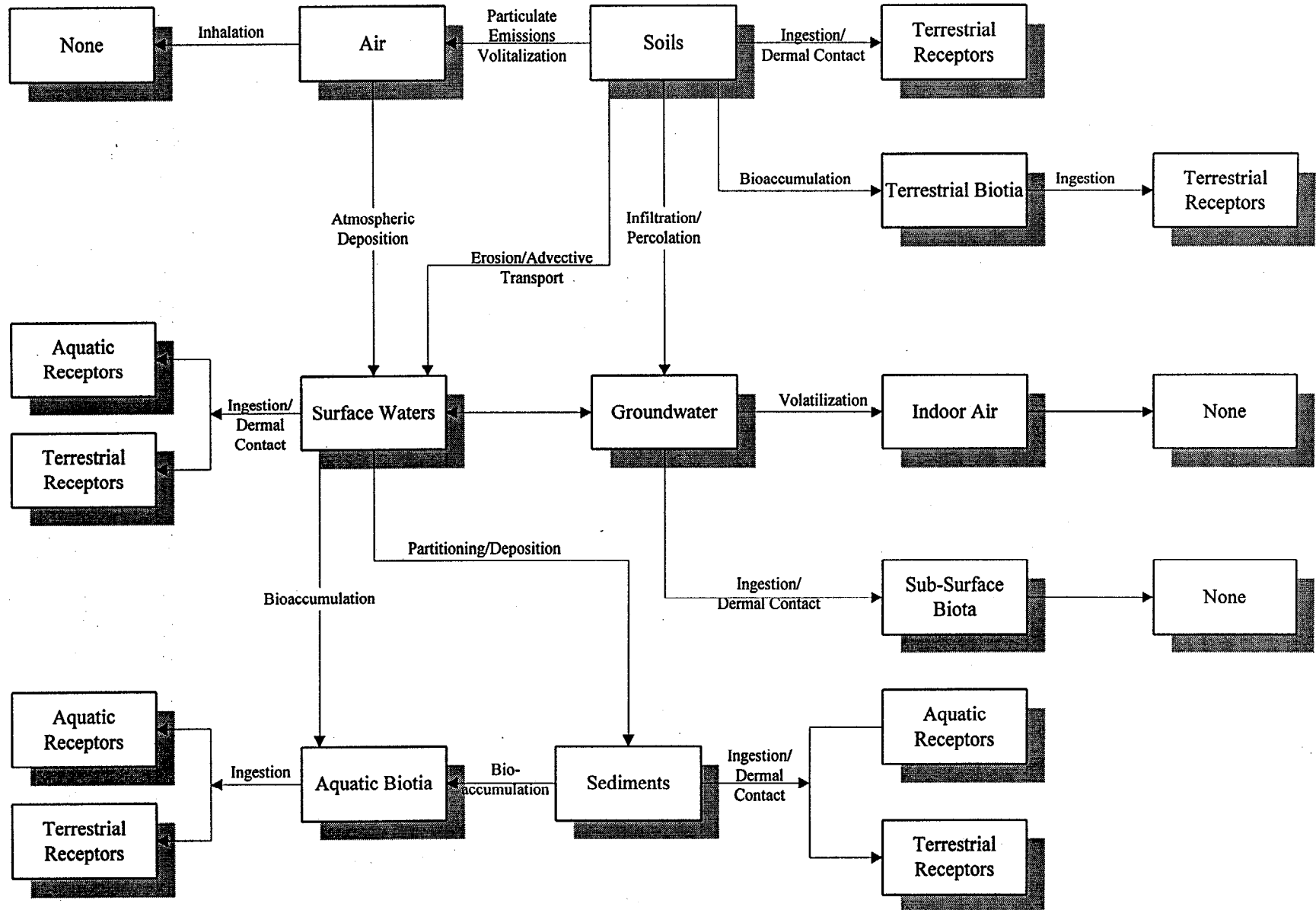
Notes:

Shaded boxes are Quotient Indices that exceed "1"

SECTION 7.0 FIGURES

FIGURE 7-1

CONCEPTUAL EXPOSURE MODEL FOR ECOLOGICAL RECEPTORS
SITE 54, CRASH CREW FIRE TRAINING BURN PIT



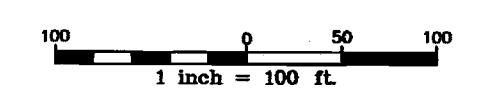
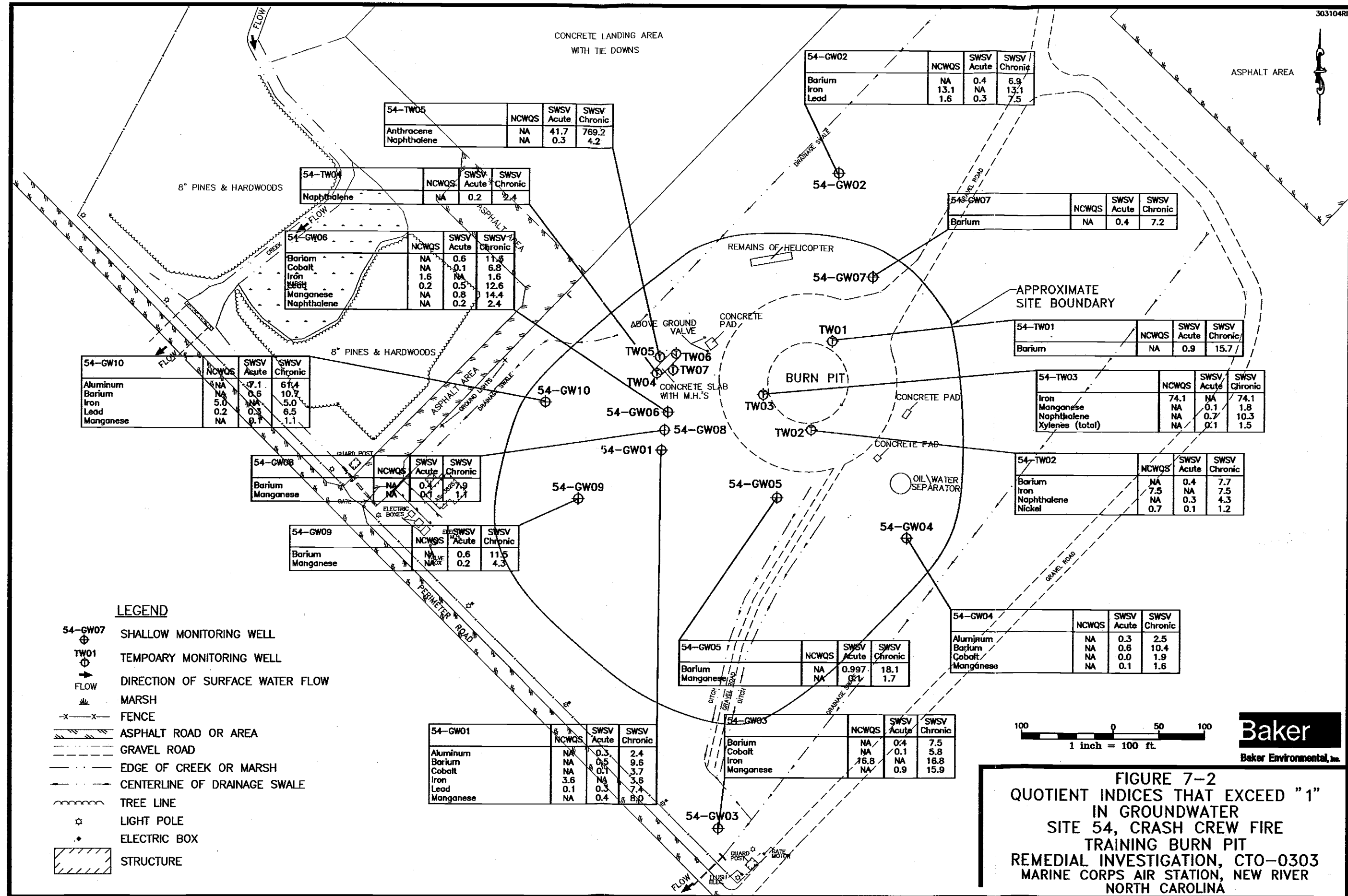


FIGURE 7-2
 QUOTIENT INDICES THAT EXCEED "1"
 IN GROUNDWATER
 SITE 54, CRASH CREW FIRE
 TRAINING BURN PIT
 REMEDIAL INVESTIGATION, CTO-0303
 MARINE CORPS AIR STATION, NEW RIVER
 NORTH CAROLINA

01717AA05Z

8.0 CONCLUSIONS AND RECOMMENDATIONS

8.1 Conclusions

The following conclusions were derived from the RI conducted at Site 54:

- Several VOCs and SVOCs were detected in groundwater at Site 54. In general, positive detections of organic compounds were limited to portions of the study area immediately adjacent to the burn pit or UST and the area extending southwest from the burn pit. Waste fuels, oils, and solvents were reportedly used in the past to simulate fire conditions; currently, only JP-type fuels are used during training exercises. While fuel is being transferred from the on-site UST to the burn pit and during training exercises, it is likely that spills onto the ground surface occur. Given the fact that the on-site UST has been successfully tested for tightness and the burn pit is lined with asphalt, this scenario is most likely the cause of organic compounds in groundwater. Accordingly, operations at the burn pit are the primary source of these compounds in groundwater.
- A number of VOCs and SVOCs were also detected in soils obtained from Site 54. In general, the observed organic compounds in soil differed from those detected in groundwater.
- Iron, manganese, and lead were found at elevated levels in groundwater at Site 54. Iron, lead, and arsenic in groundwater generated unacceptable risks to human receptors. Groundwater discharge to the site surface water is not expected to cause a significant decrease in the aquatic population.

8.2 Recommendations

The following recommendations are provided based on the RI findings:

- Measures should be taken to convert the existing burn pit operation from petroleum fuel-based to propane or natural gas to reduce the on-going contaminant source.
- Groundwater within the southwestern and southern portion of Site 54 should be sampled as part of a long-term monitoring due to the presence volatile compounds.